

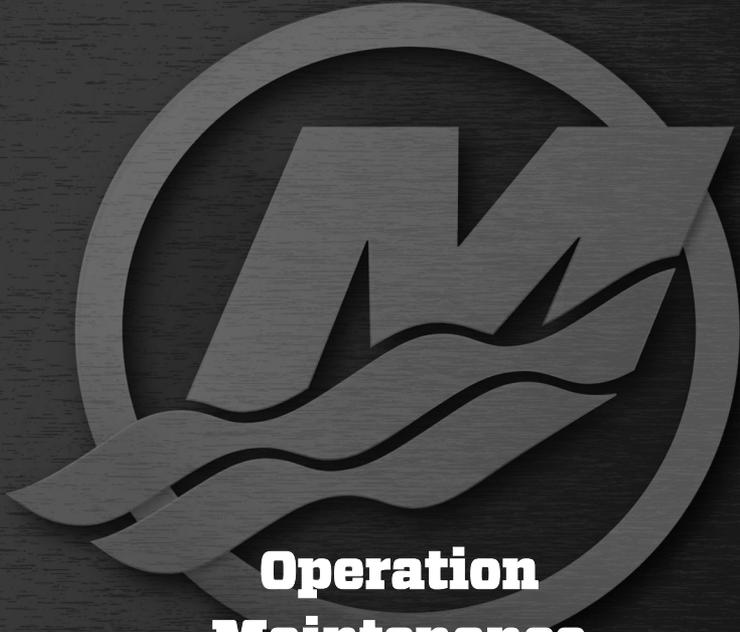

MERCURY
GO BOLDLY.™

8M013362Z 617 eng

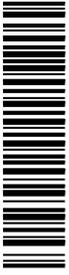

**Operation
Maintenance
and
Installation
Manual**

9.9/10/15 TwoStroke

© 2017 Mercury Marine

Welcome

You have selected one of the finest marine power packages available. It incorporates numerous design features to ensure operating ease and durability. With proper care and maintenance, you will enjoy using this product for many boating seasons. To ensure maximum performance and carefree use, we ask that you thoroughly read this manual.

The Operation and Maintenance Manual contains specific instructions for using and maintaining your product. We suggest that this manual remain with the product for ready reference whenever you are on the water.

Thank you for purchasing one of our products. We sincerely hope your boating will be pleasant!

Mercury Marine, Fond du Lac, Wisconsin, U.S.A.

Name / function:

John Pfeifer, President,
Mercury Marine



Read This Manual Thoroughly

IMPORTANT: If you do not understand any portion of this manual, contact your dealer. Your dealer can also provide a demonstration of actual starting and operating procedures.

Notice

Throughout this publication, and on your power package, warnings, cautions,

and notices, accompanied by the International Hazard Symbol , may be used to alert the installer and user to special instructions concerning a particular service or operation that may be hazardous if performed incorrectly or carelessly. Observe them carefully.

These safety alerts alone cannot eliminate the hazards that they signal. Strict compliance with these special instructions while performing the service, plus common sense operation, are major accident prevention measures.

WARNING

Indicates a hazardous situation which, if not avoided, could result in death or serious injury.

CAUTION

Indicates a hazardous situation which, if not avoided, could result in minor or moderate injury.

NOTICE

Indicates a situation which, if not avoided, could result in engine or major component failure.

IMPORTANT: Identifies information essential to the successful completion of the task.

NOTE: Indicates information that helps in the understanding of a particular step or action.

IMPORTANT: The operator (driver) is responsible for the correct and safe operation of the boat, the equipment aboard, and the safety of all occupants aboard. We strongly recommend that the operator read this Operation and Maintenance Manual and thoroughly understand the operational instructions for the power package and all related accessories before the boat is used.

⚠ WARNING

The engine exhaust from this product contains chemicals known to the state of California to cause cancer, birth defects or other reproductive harm.

The serial numbers are the manufacturer's keys to numerous engineering details that apply to your Mercury Marine power package. When contacting Mercury Marine about service, **always specify model and serial numbers.**

Descriptions and specifications contained herein were in effect at the time this was approved for printing. Mercury Marine, whose policies are based on continuous improvement, reserves the right to discontinue models at any time or to change specifications or designs without notice and without incurring obligation.

Warranty Message

The product you have purchased comes with a **limited warranty** from Mercury Marine; the terms of the warranty are set forth in the Warranty Manual included with the product. The Warranty Manual contains a description of what is covered, what is not covered, the duration of coverage, how to best obtain warranty coverage, **important disclaimers and limitations of damages**, and other related information. Please review this important information.

Mercury Marine products are designed and manufactured to comply with our own high quality standards, applicable industry standards and regulations, as well as certain emissions regulations. At Mercury Marine every engine is operated and tested before it is boxed for shipment to make sure that the product is ready for use. In addition, certain Mercury Marine products are tested in a controlled and monitored environment, for up to 10 hours of engine run time, in order to verify and make a record of compliance with applicable standards and regulations. All Mercury Marine product, sold as new, receives the applicable limited warranty coverage, whether the engine participated in one of the test programs described above or not.

Copyright and Trademark Information

© MERCURY MARINE. All rights reserved. Reproduction in whole or in part without permission is prohibited.

Alpha, Axis, Bravo One, Bravo Two, Bravo Three, Circle M with Waves Logo, K-planes, Mariner, MerCathode, MerCruiser, Mercury, Mercury with Waves Logo, Mercury Marine, Mercury Precision Parts, Mercury Propellers, Mercury Racing, MotorGuide, OptiMax, Quicksilver, SeaCore, Skyhook, SmartCraft, Sport-Jet, Verado, VesselView, Zero Effort, Zeus, #1 On the Water and We're Driven to Win are registered trademarks of Brunswick Corporation. Pro XS is a trademark of Brunswick Corporation. Mercury Product Protection is a registered service mark of Brunswick Corporation.

Identification Records

Please record the following applicable information:

Outboard		
Engine Model and Horsepower		
Engine Serial Number		
Gear Ratio		
Propeller Number	Pitch	Diameter
Hull Identification Number (HIN)		Purchase Date
Boat Manufacturer	Boat Model	Length
Exhaust Gas Emissions Certification Number (Europe Only)		

General Information

Boater's Responsibilities.....	1
Before Operating Your Outboard.....	1
Boat Horsepower Capacity.....	1
High-Speed and High-Performance Boat Operation.....	2
Outboard Remote Control Models	2
Remote Steering Notice.....	3
Lanyard Stop Switch.....	3
Protecting People in the Water.....	6
Passenger Safety Message - Pontoon Boats and Deck Boats.....	6
Wave and Wake Jumping.....	8
Impact with Underwater Hazards.....	9
Safety Instructions for Hand-Tilled Outboards.....	10
Exhaust Emissions.....	10
Selecting Accessories for Your Outboard.....	12
Safe Boating Suggestions.....	12
Recording Serial Number	14
Model Year Production Code.....	14
Specifications.....	15

Transporting

Carrying Outboard.....	16
Trailing Boat.....	16
Transporting Outboard When Removed From Boat.....	17
Transporting Portable Fuel Tanks.....	17

Fuel and Oil

Fuel Requirements.....	19
Oil Recommendation.....	20
Mixing Fuel and Oil.....	20
Filling Fuel Tank.....	21

Features and Controls

Tiller Handle Models.....	22
Remote Control Models - Manual Start.....	24
Remote Control Models - Electric Start.....	26
Tilting Outboard.....	27
Shallow Water Operation.....	28
Setting The Transom Angle Of Your Outboard	29
Adjusting Transom Angle.....	31

Operation

Prestarting Check List.....	32
Operating in Freezing Temperatures.....	32
Operating in Saltwater or Polluted Water.....	32
Operating at High Elevations.....	33
Operating Outboard as an Auxiliary Engine.....	33
Prestarting Instructions.....	33
Engine Break-in Procedure.....	34
Starting the Engine - Tiller Handle Models and Manual Start Remote Control Models.....	34
Starting the Engine - Electric Start Remote Control Models.....	37
Gear Shifting.....	40
Stopping the Engine	41
Emergency Starting	41

Maintenance

Cleaning Care Recommendations.....	45
EPA Regulations.....	47
EPA Emissions.....	47
Inspection and Maintenance Schedule.....	48
Flushing The Cooling System.....	49
Top Cowl Removal and Installation.....	50
Battery Inspection	51
Fuel System.....	51
Exterior Care.....	52
Steering Link Rod Fasteners.....	53
Fuse Replacement - Electric Start Remote Control Models.....	54
Corrosion Control Anode.....	54
Propeller Replacement.....	55
Spark Plug Inspection And Replacement.....	57
Carburetor Adjustments.....	58
Lubrication Points	59
Gearcase Lubrication.....	63
Submerged Outboard.....	64

Storage

Storage Preparation.....	65
Protecting External Outboard Components.....	65
Protecting Internal Engine Components.....	66
Gearcase.....	66
Positioning Outboard for Storage.....	66
Battery Storage.....	66

Troubleshooting

Starter Motor Will Not Crank the Engine (Electric Start Models).....	67
Engine Will Not Start.....	67
Engine Runs Erratically.....	67
Performance Loss.....	68
Battery Will Not Hold Charge.....	68

Owner Service Assistance

Service Assistance.....	69
Ordering Literature.....	71

Installation

Mercury Marine Validated Engine Mounting Hardware.....	73
Installing Outboard.....	73
Battery Installation - Electric Start Models.....	75
Battery Connections.....	75
Propeller Selection.....	76

Maintenance Log

Maintenance Log.....	77
----------------------	----

GENERAL INFORMATION

Boater's Responsibilities

The operator (driver) is responsible for the correct and safe operation of the boat and the safety of its occupants and general public. It is strongly recommended that each operator read and understand this entire manual before operating the outboard.

Be sure that at least one additional person onboard is instructed in the basics of starting and operating the outboard and boat handling in case the driver is unable to operate the boat.

Before Operating Your Outboard

Read this manual carefully. Learn how to operate your outboard properly. If you have any questions, contact your dealer.

Safety and operating information that is practiced, along with using good common sense, can help prevent personal injury and product damage.

This manual as well as safety labels posted on the outboard use the following safety alerts to draw your attention to special safety instructions that should be followed.

WARNING

Indicates a hazardous situation which, if not avoided, could result in death or serious injury.

CAUTION

Indicates a hazardous situation which, if not avoided, could result in minor or moderate injury.

NOTICE

Indicates a situation which, if not avoided, could result in engine or major component failure.

Boat Horsepower Capacity

WARNING

Exceeding the boat's maximum horsepower rating can cause serious injury or death. Overpowering the boat can affect boat control and flotation characteristics or break the transom. Do not install an engine that exceeds the boat's maximum power rating.

GENERAL INFORMATION

Do not overpower or overload your boat. Most boats will carry a required capacity plate indicating the maximum acceptable power and load as determined by the manufacturer following certain federal guidelines. If in doubt, contact your dealer or the boat manufacturer.

U.S. COAST GUARD CAPACITY	
MAXIMUM HORSEPOWER	XXX
MAXIMUM PERSON CAPACITY (POUNDS)	XXX
MAXIMUM WEIGHT CAPACITY	XXX

26777

High-Speed and High-Performance Boat Operation

If your outboard is to be used on a high-speed or high-performance boat with which you are unfamiliar, we recommend that you do not operate it at its high speed capability without first requesting an initial orientation and familiarization demonstration ride with your dealer or an operator experienced with your boat/outboard combination. For additional information, obtain a copy of our **Hi-Performance Boat Operation** booklet from your dealer, distributor, or Mercury Marine.

Outboard Remote Control Models

The remote control connected to your outboard must be equipped with a start in neutral only protection device. This prevents the engine from starting when the shift is actuated in any position other than neutral.

⚠ WARNING

Starting the engine with the drive in gear can cause serious injury or death. Never operate a boat that does not have a neutral-safety-protection device.



GENERAL INFORMATION

Remote Steering Notice

⚠ WARNING

Improper fasteners or improper installation procedures can result in loosening or disengagement of the steering link rod. This can cause a sudden, unexpected loss of boat control, resulting in serious injury or death due to occupants being thrown within or out of the boat. Always use required components and follow instructions and torque procedures.

The steering link rod that connects the steering cable to the engine must be fastened utilizing self-locking nuts. These self-locking nuts must never be replaced with common nuts (non-locking) as they will work loose and vibrate off, freeing the link rod to disengage.

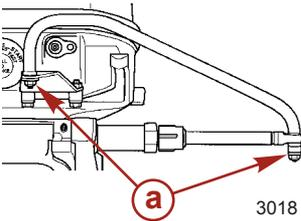

a - Self-locking nuts

Lanyard Stop Switch

The purpose of a lanyard stop switch is to turn off the engine when the operator moves far enough away from the operator's position (as in accidental ejection from the operator's position) to activate the switch. Tiller handle outboards and some remote control units are equipped with a lanyard stop switch. A lanyard stop switch can be installed as an accessory - generally on the dashboard or side adjacent to the operator's position.

A decal near the lanyard stop switch is a visual reminder for the operator to attach the lanyard to their personal flotation device (PFD) or wrist.

GENERAL INFORMATION

The lanyard cord is usually 122–152 cm (4–5 feet) in length when stretched out, with an element on one end made to be inserted into the switch and a clip on the other end for attaching to the operator's PFD or wrist. The lanyard is coiled to make its at-rest condition as short as possible to minimize the likelihood of lanyard entanglement with nearby objects. Its stretched-out length is made to minimize the likelihood of accidental activation should the operator choose to move around in an area close to the normal operator's position. If it is desired to have a shorter lanyard, wrap the lanyard around the operator's wrist or leg, or tie a knot in the lanyard.

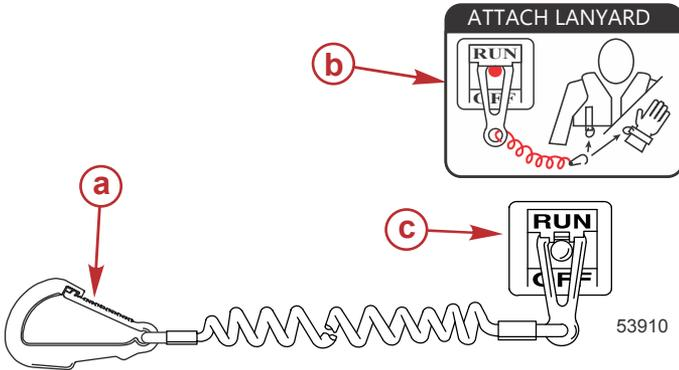

- a - Lanyard cord clip
- b - Lanyard decal
- c - Lanyard stop switch

Read the following Safety Information before proceeding.

Important Safety Information: The purpose of a lanyard stop switch is to stop the engine when the operator moves far enough away from the operator's position to activate the switch. This would occur if the operator accidentally falls overboard or moves within the boat a sufficient distance from the operator's position. Falling overboard and accidental ejections are more likely to occur in certain types of boats such as low sided inflatables, bass boats, high performance boats, and light, sensitive handling fishing boats operated by a hand tiller. Falling overboard and accidental ejections are also likely to occur as a result of poor operating practices such as sitting on the back of the seat or gunwale at planing speeds, standing at planing speeds, sitting on elevated fishing boat decks, operating at planing speeds in shallow or obstacle infested waters, releasing your grip on a steering wheel or tiller handle that is pulling in one direction, drinking alcohol or consuming drugs, or daring high speed boat maneuvers.

GENERAL INFORMATION

While activation of the lanyard stop switch will stop the engine immediately, a boat will continue to coast for some distance depending upon the velocity and degree of any turn at shut down. However, the boat will not complete a full circle. While the boat is coasting, it can cause injury to anyone in the boat's path as seriously as the boat would when under power.

We strongly recommend that other occupants be instructed on proper starting and operating procedures should they be required to operate the engine in an emergency (if the operator is accidentally ejected).

⚠ WARNING

If the operator falls out of the boat, stop the engine immediately to reduce the possibility of serious injury or death from being struck by the boat. Always properly connect the operator to the stop switch using a lanyard.

⚠ WARNING

Avoid serious injury or death from deceleration forces resulting from accidental or unintended stop switch activation. The boat operator should never leave the operator's station without first disconnecting the stop switch lanyard from the operator.

Accidental or unintended activation of the switch during normal operation is also a possibility. This could cause any, or all, of the following potentially hazardous situations:

- Occupants could be thrown forward due to unexpected loss of forward motion - a particular concern for passengers in the front of the boat who could be ejected over the bow and possibly struck by the gearcase or propeller.
- Loss of power and directional control in heavy seas, strong current, or high winds.
- Loss of control when docking.

KEEP THE LANYARD STOP SWITCH AND LANYARD CORD IN GOOD OPERATING CONDITION

Before each use, check to ensure the lanyard stop switch works properly. Start the engine and stop it by pulling the lanyard cord. If the engine does not stop, have the switch repaired before operating the boat.

Before each use, visually inspect the lanyard cord to ensure it is in good working condition and that there are no breaks, cuts, or wear to the cord. Check that the clips on the ends of the cord are in good condition. Replace any damaged or worn lanyard cords.

GENERAL INFORMATION

Protecting People in the Water

WHILE YOU ARE CRUISING

It is very difficult for a person standing or floating in the water to take quick action to avoid a boat heading in his/her direction, even at slow speed.



Always slow down and exercise extreme caution any time you are boating in an area where there might be people in the water.

Whenever a boat is moving (coasting) and the outboard gear shift is in neutral position, there is sufficient force by the water on the propeller to cause the propeller to rotate. This neutral propeller rotation can cause serious injury.

WHILE THE BOAT IS STATIONARY

▲ WARNING

A spinning propeller, a moving boat, or any solid device attached to the boat can cause serious injury or death to swimmers. Stop the engine immediately whenever anyone in the water is near your boat.

Shift the outboard into neutral and shut off the engine before allowing people to swim or be in the water near your boat.

Passenger Safety Message - Pontoon Boats and Deck Boats

Whenever the boat is in motion, observe the location of all passengers. Do not allow any passengers to stand or use seats other than those designated for traveling faster than idle speed. A sudden reduction in boat speed, such as plunging into a large wave or wake, a sudden throttle reduction, or a sharp change of boat direction, could throw them over the front of the boat. Falling over the front of the boat between the two pontoons will position them to be run over by the outboard.

BOATS HAVING AN OPEN FRONT DECK

No one should ever be on the deck in front of the fence while the boat is in motion. Keep all passengers behind the front fence or enclosure.

GENERAL INFORMATION

Persons on the front deck could easily be thrown overboard or persons dangling their feet over the front edge could get their legs caught by a wave and pulled into the water.

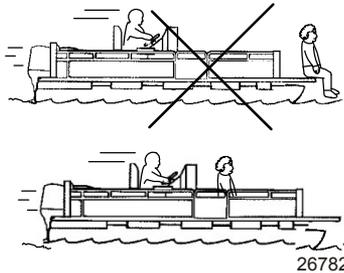

⚠ WARNING

Sitting or standing in an area of the boat not designed for passengers at speeds above idle can cause serious injury or death. Stay back from the front end of deck boats or raised platforms and remain seated while the boat is in motion.

BOATS WITH FRONT MOUNTED, RAISED PEDESTAL FISHING SEATS

Elevated fishing seats are not intended for use when the boat is traveling faster than idle or trolling speed. Sit only in seats designated for traveling at faster speeds.

Any unexpected, sudden reduction in boat speed could result in the elevated passenger falling over the front of the boat.

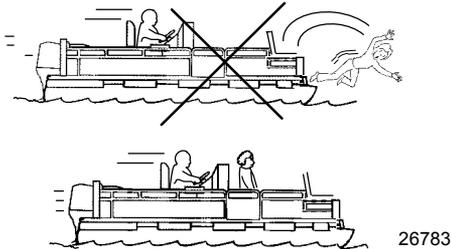

GENERAL INFORMATION

Wave and Wake Jumping

Operating recreational boats over waves and wake is a natural part of boating. However, when this activity is done with sufficient speed to force the boat hull partially or completely out of the water, certain hazards arise, particularly when the boat enters the water.

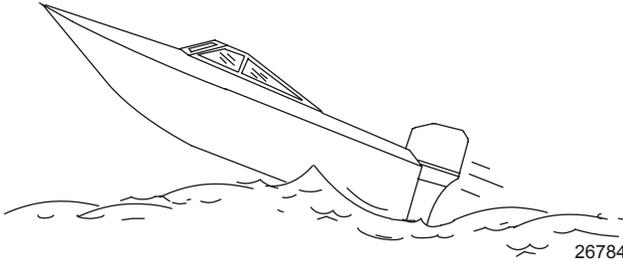

The primary concern is the boat changing direction while in the midst of the jump. In such case, the landing may cause the boat to veer violently in a new direction. Such a sharp change in direction can cause occupants to be thrown out of their seats, or out of the boat.

⚠ WARNING

Wave or wake jumping can cause serious injury or death from occupants being thrown within or out of the boat. Avoid wave or wake jumping whenever possible.

There is another less common hazardous result from allowing your boat to launch off a wave or wake. If the bow of your boat pitches down far enough while airborne, upon water contact it may penetrate under the water surface and submarine for an instant. This will bring the boat to a nearly instantaneous stop and can send the occupants flying forward. The boat may also steer sharply to one side.

GENERAL INFORMATION

Impact with Underwater Hazards

Reduce speed and proceed with caution whenever you drive a boat in shallow water areas, or in areas where you suspect underwater obstacles may exist which could be struck by the outboard or the boat bottom. **The most important thing you can do to help reduce injury or impact damage from striking a floating or underwater object is to control the boat speed. Under these conditions, boat speed should be kept to a minimum planing speed of 24 to 40 km/h (15 to 25 mph).**

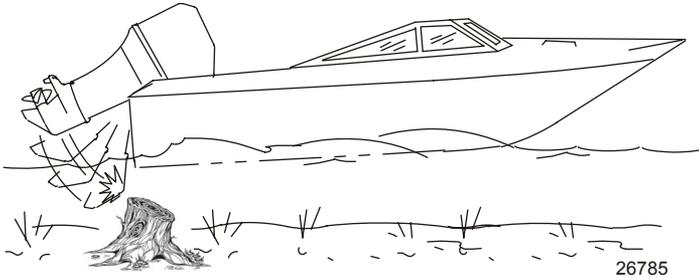

Striking a floating or underwater object could result in an infinite number of situations. Some of these situations could result in the following:

- Part of the outboard or the entire outboard could break loose and fly into the boat.
- The boat could move suddenly in a new direction. Such a sharp change in direction can cause occupants to be thrown out of their seats or out of the boat.
- A rapid reduction in speed. This will cause occupants to be thrown forward, or even out of the boat.
- Impact damage to the outboard and/or boat.

Keep in mind, the most important thing you can do to help reduce injury or impact damage during an impact is control the boat speed. Boat speed should be kept to a minimum planing speed when driving in waters known to have underwater obstacles.

After striking a submerged object, stop the engine as soon as possible and inspect it for any broken or loose parts. If damage is present or suspected, the outboard should be taken to an authorized dealer for a thorough inspection and necessary repair.

The boat should also be checked for any hull fractures, transom fractures, or water leaks.

Operating a damaged outboard could cause additional damage to other parts of the outboard, or could affect control of the boat. If continued running is necessary, do so at greatly reduced speeds.

GENERAL INFORMATION

▲ WARNING

Operating a boat or engine with impact damage can result in product damage, serious injury, or death. If the vessel experiences any form of impact, have an authorized Mercury Marine dealer inspect and repair the vessel or power package.

Safety Instructions for Hand-Tilled Outboards

No person or cargo should occupy the area directly in front of the outboard while the boat is in motion. If an underwater obstacle is struck, the outboard will tilt up and could seriously injure anyone occupying this area.

MODELS WITH CLAMP SCREWS:

Some outboards come with transom bracket clamp screws. The use of clamp bracket screws alone, is insufficient to properly and safely secure the outboard to the transom. Proper installation of the outboard includes bolting the engine to the boat through the transom. Refer to **Installation - Installing Outboard** for more complete installation information.

▲ WARNING

Failure to correctly fasten the outboard could result in the outboard propelling off the boat transom resulting in property damage, serious injury, or death. Before operation, the outboard must be correctly installed with the required mounting hardware.

If an obstacle is struck at planing speed and the outboard is not securely fastened to the transom, it is possible the outboard could lift off the transom and land in the boat.

Exhaust Emissions

BE ALERT TO CARBON MONOXIDE POISONING

Carbon monoxide (CO) is a deadly gas that is present in the exhaust fumes of all internal combustion engines, including the engines that propel boats, and the generators that power boat accessories. By itself, CO is odorless, colorless, and tasteless, but if you can smell or taste engine exhaust, you are inhaling CO.

Early symptoms of carbon monoxide poisoning, which are similar to the symptoms of seasickness and intoxication, include headache, dizziness, drowsiness, and nausea.

GENERAL INFORMATION

⚠ WARNING

Inhaling engine exhaust gases can result in carbon monoxide poisoning, which can lead to unconsciousness, brain damage, or death. Avoid exposure to carbon monoxide.

Stay clear from exhaust areas when engine is running. Keep the boat well-ventilated while at rest or underway.

STAY CLEAR OF EXHAUST AREAS

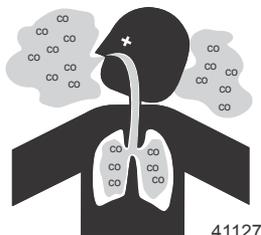

Engine exhaust gases contain harmful carbon monoxide. Avoid areas of concentrated engine exhaust gases. When engines are running, keep swimmers away from the boat, and do not sit, lie, or stand on swim platforms or boarding ladders. While underway, do not allow passengers to be positioned immediately behind the boat (platform dragging, teak/body surfing). This dangerous practice not only places a person in an area of high engine exhaust concentration, but also subjects them to the possibility of injury from the boat propeller.

GOOD VENTILATION

Ventilate the passenger area, open side curtains or forward hatches to remove fumes.

Example of desired air flow through the boat:

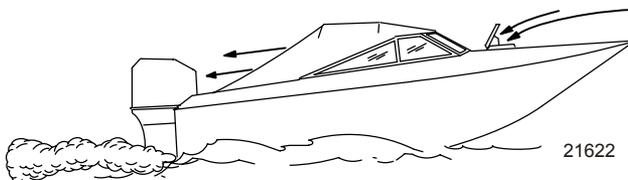

POOR VENTILATION

Under certain running and/or wind conditions, permanently enclosed or canvas enclosed cabins or cockpits with insufficient ventilation may draw in carbon monoxide. Install one or more carbon monoxide detectors in your boat.

Although the occurrence is rare, on a very calm day, swimmers and passengers in an open area of a stationary boat that contains, or is near, a running engine may be exposed to a hazardous level of carbon monoxide.

GENERAL INFORMATION

1. Examples of poor ventilation while the boat is stationary:

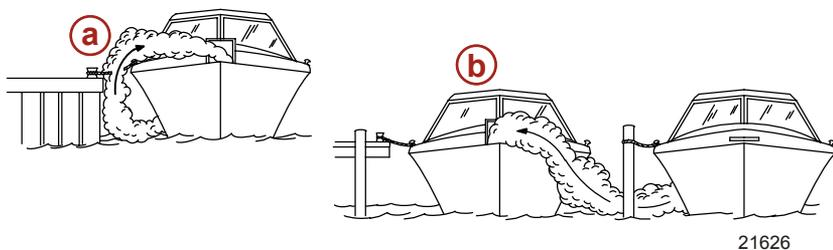

- a - Operating the engine when the boat is moored in a confined space
- b - Mooring close to another boat that has its engine operating

2. Examples of poor ventilation while the boat is moving:

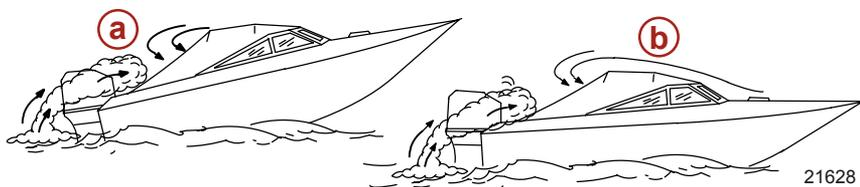

- a - Operating the boat with the trim angle of the bow too high
- b - Operating the boat with no forward hatches open (station wagon effect)

Selecting Accessories for Your Outboard

Genuine Mercury Precision or Quicksilver Accessories have been specifically designed and tested for your outboard. These accessories are available from Mercury Marine dealers.

IMPORTANT: Check with your dealer before installing accessories. The misuse of approved accessories or the use of nonapproved accessories can damage the product.

Some accessories not manufactured or sold by Mercury Marine are not designed to be safely used with your outboard or outboard operating system. Acquire and read the installation, operation and maintenance manuals for all your selected accessories.

Safe Boating Suggestions

In order to safely enjoy the waterways, familiarize yourself with local and other governmental boating regulations and restrictions, and consider the following suggestions.

Use flotation devices. Have an approved personal flotation device of suitable size for each person aboard (it is the law) and have it readily accessible.

GENERAL INFORMATION

Do not overload your boat. Most boats are rated and certified for maximum load (weight) capacities (refer to your boat capacity plate). If in doubt, contact your dealer or the boat's manufacturer.

Perform safety checks and required maintenance. Follow a regular schedule and ensure that all repairs are properly made.

Know and obey all nautical rules and laws of the waterways. Boat operators should complete a boating safety course. Courses are offered in the U.S.A. by 1) the U.S. Coast Guard Auxiliary, 2) the Power Squadron, 3) the Red Cross, and 4) your state boating law enforcement agency. Inquiries may be made to the Boating Hotline, 1-800-368-5647 or the Boat U.S. Foundation information number 1-800-336-BOAT.

Make sure everyone in the boat is properly seated. Do not allow anyone to sit or ride on any part of the boat that was not intended for such use. This includes the back of seats, gunwales, transom, bow, decks, raised fishing seats, any rotating fishing seat; or anywhere that an unexpected acceleration, sudden stopping, unexpected loss of boat control, or sudden boat movement could cause a person to be thrown overboard or into the boat.

Never be under the influence of alcohol or drugs while boating (it is the law). Alcohol or drug use impairs your judgment and greatly reduces your ability to react quickly.

Prepare other boat operators. Instruct at least one other person onboard in the basics of starting and operating the outboard, and boat handling, in case the driver becomes disabled or falls overboard.

Passenger boarding. Stop the engine whenever passengers are boarding, unloading, or are near the back (stern) of the boat. Just shifting the outboard into neutral is not sufficient.

Be alert. The operator of the boat is responsible by law to maintain a proper lookout by sight and hearing. The operator must have an unobstructed view particularly to the front. No passengers, load, or fishing seats should block the operator's view when operating the boat above idle speed.

Never drive your boat directly behind a water-skier in case the skier falls. As an example, your boat traveling at 40 km/h (25 MPH) will overtake a fallen skier 61 m (200 ft) in front of you in 5 seconds.

Watch fallen skiers. When using your boat for waterskiing or similar activities, always keep a fallen or down skier on the operator's side of the boat while returning to assist the skier. The operator should always have the down skier in sight and never back up to the skier or anyone in the water.

Report accidents. Boat operators are required by law to file a Boating Accident Report with their state boating law enforcement agency when their boat is involved in certain boating accidents. A boating accident must be reported if 1) there is loss of life or probable loss of life, 2) there is personal injury requiring medical treatment beyond first aid, 3) there is damage to boats or other property where the damage value exceeds \$500.00, or 4) there is complete loss of the boat. Seek further assistance from local law enforcement.

GENERAL INFORMATION

Recording Serial Number

It is important to record this number for future reference. The serial number is located on the outboard as shown.

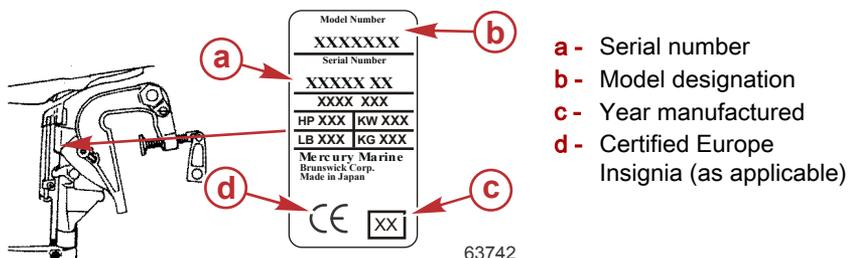

Model Year Production Code

The serial number decal lists the year of manufacture as an alpha code. This code can be deciphered into a corresponding number utilizing the following table.



Serial number decal alpha code

Model Year Manufactured Code										
Alpha Production Code	A	B	C	D	E	F	G	H	K	X
Corresponding Number	1	2	3	4	5	6	7	8	9	0

Examples:

- XX = 2000
- HK = 2089
- AG = 2017

GENERAL INFORMATION

Specifications

Models	9.9	10	15
Horsepower	9.9	10	15
Kilowatts	7.3	7.4	11.0
Full Throttle RPM Range	5000–6000		
Idle Speed in Forward Gear	725 ± 50		
Number of Cylinders	2		
Piston Displacement	262 cc (16.0 cu. in.)		
Cylinder Bore	60.3 mm (2.375 in.)		
Piston Stroke	45.7 mm (1.8 in.)		
Recommended Spark Plug	NGK BP8HS-15		
Spark Plug Gap	1.5 mm (0.060 in.)		
Gear Ratio	2.0:1		
Recommended Gasoline	Refer to Fuel and Oil		
Recommended Oil	Refer to Fuel and Oil		
Gearcase Lubricant Capacity	200 ml (6.8 fl oz)		
Battery Rating	465 marine cranking amps (MCA) or 350 cold cranking amps (CCA)		
Amp Hours (Ah)	70–100		

TRANSPORTING

Carrying Outboard

The outboard has a carrying handle located in front and a rear hand grip in the bottom cowl.

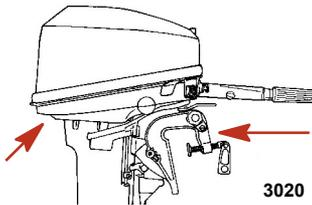

Trailing Boat

IMPORTANT: The tilt lock mechanism is not intended to support the outboard in the tilted up position when trailering. Use of the tilt lock mechanism could allow the outboard to bounce and drop down causing damage to the outboard.

The boat should be trailered with the outboard tilted down (normal operating position).

If additional ground clearance is required, the outboard should be tilted up using an accessory outboard support device. Refer to your local dealer for recommendations. Additional clearance may be required for railroad crossings, driveways and trailer bouncing.

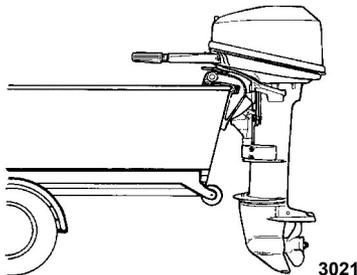

⚠ WARNING

Rotating propellers can cause serious injury or death, even if the engine is not operating. Before transportation, shift the drive unit into gear to prevent the propeller from rotating.

Set the gear shift into forward gear. This prevents the propeller from spinning freely.

TRANSPORTING

Transporting Outboard When Removed From Boat

1. With the outboard still in the water, disconnect the fuel line from the outboard and run engine until it stops. This will drain fuel from the carburetor. Remove outboard from the boat and hold upright until all cooling water is drained out.
2. Lay the outboard down horizontally on its tiller handle side. Place a protective pad under the outboard.

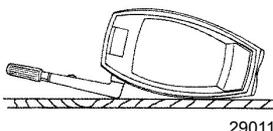

Transporting Portable Fuel Tanks

⚠ WARNING

Avoid serious injury or death from a gasoline fire or explosion. Follow the transporting instructions supplied with the portable fuel tank. Transport the fuel tank in a well ventilated area away from open flame or sparks.

MANUAL VENTING TYPE FUEL TANK

Close the fuel tank air vent when transporting tank. This will prevent escape of fuel or vapors from tank.

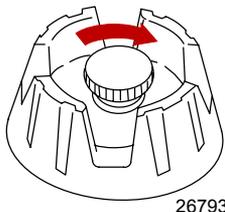

AUTO-VENTING TYPE FUEL TANK

1. Disconnect the remote fuel line from tank. This will close the air vent and prevent escape of fuel or vapors from tank.

TRANSPORTING

2. Install tether cap over the fuel line connector stem. This will protect the connector stem from being accidentally pushed-in, allowing fuel or vapor to escape.

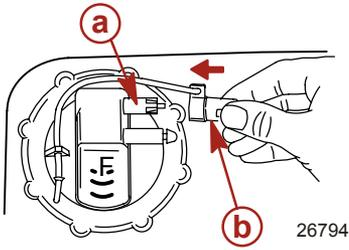

a - Connector stem

b - Tether cap

FUEL AND OIL

Fuel Requirements

IMPORTANT: Use of improper gasoline can damage your engine. Engine damage resulting from the use of improper gasoline is considered misuse of the engine and will not be covered under the limited warranty.

FUEL RATINGS

Mercury outboard engines will operate satisfactorily with any major brand of unleaded gasoline that meets the following specifications:

USA and Canada - A posted pump octane rating of 87 (R+M)/2, minimum, for most models. Premium gasoline 91 (R+M)/2 octane is also acceptable for most models. **Do not** use leaded gasoline.

Outside USA and Canada - A posted pump octane rating of 91 RON, minimum, for most models. Premium gasoline (95 RON) is also acceptable for all models. **Do not** use leaded gasoline.

USING REFORMULATED (OXYGENATED) GASOLINE (USA ONLY)

Reformulated gasoline is required in certain areas of the USA and is acceptable for use in your Mercury Marine engine. The only oxygenate currently in use in the USA is alcohol (ethanol, methanol, or butanol).

GASOLINE CONTAINING ALCOHOL

Bu16 Butanol Fuel Blends

Fuel blends of up to 16.1% butanol (Bu16) that meet the published Mercury Marine fuel rating requirements are an acceptable substitute for unleaded gasoline. Contact your boat manufacturer for specific recommendations on your boat's fuel system components (fuel tanks, fuel lines, and fittings).

Methanol and Ethanol Fuel Blends

IMPORTANT: The fuel system components on your Mercury Marine engine will withstand up to 10% alcohol (methanol or ethanol) content in the gasoline. Your boat's fuel system may not be capable of withstanding the same percentage of alcohol. Contact your boat manufacturer for specific recommendations on your boat's fuel system components (fuel tanks, fuel lines, and fittings).

Be aware that gasoline containing methanol or ethanol may cause increased:

- Corrosion of metal parts
- Deterioration of rubber or plastic parts
- Fuel permeation through the rubber fuel lines
- Likelihood of phase separation (water and alcohol separating from the gasoline in the fuel tank)

FUEL AND OIL

⚠ WARNING

Fuel leakage is a fire or explosion hazard, which can cause serious injury or death. Periodically inspect all fuel system components for leaks, softening, hardening, swelling, or corrosion, particularly after storage. Any sign of leakage or deterioration requires replacement before further engine operation.

IMPORTANT: If you use gasoline that contains or might contain methanol or ethanol, you must increase the frequency of inspection for leaks and abnormalities.

IMPORTANT: When operating a Mercury Marine engine on gasoline containing methanol or ethanol, do not store the gasoline in the fuel tank for long periods. Cars normally consume these blended fuels before they can absorb enough moisture to cause trouble; boats often sit idle long enough for phase separation to take place. Internal corrosion may occur during storage if alcohol has washed protective oil films from internal components.

Oil Recommendation

Recommended Oil	Mercury or Quicksilver Premium 2-Cycle TC-W3 Outboard Oil
-----------------	-----------------------------------------------------------

IMPORTANT: Oil must be NMMA certified TC-W3 2-Cycle oil.

Mercury or Quicksilver Premium TC-W3 2-Cycle oil is recommended for this engine. For added protection and lubrication, Mercury or Quicksilver Premium Plus TC-W3 2-Cycle oil is recommended. If Mercury or Quicksilver outboard oil is not available, substitute another brand of 2-cycle outboard oil that is NMMA Certified TC-W3. Severe engine damage may result from use of an inferior oil.

Mixing Fuel and Oil

Use a 25:1 (4%) gasoline/oil mixture in the first tank of fuel.

After the break-in fuel mixture is used up, use a 50:1 (2%) gasoline/oil mixture. Refer to the table (following) for mixing ratios.

GASOLINE/OIL MIXING RATIO CHART

GASOLINE/OIL MIXING RATIO CHART			
Gas/Oil Ratio	3.8 liters (1 gal) gas	11.5 liters (3 gal) gas	23 liters (6 gal) gas
25:1 (4%)	148 ml (5 fl oz) oil	473 ml (16 fl oz) oil	946 ml (32 fl oz) oil
50:1 (2%)	89 ml (3 fl oz) oil	237 ml (8 fl oz) oil	473 ml (16 fl oz) oil

MIXING PROCEDURE

Pour the full amount of oil along with approximately one gallon of gasoline into an approved container. Shake the two together until they are thoroughly mixed. Add the remainder of gasoline and shake container to ensure mixing.

FUEL AND OIL

Filling Fuel Tank

⚠ WARNING

Avoid serious injury or death from a gasoline fire or explosion. Use caution when filling fuel tanks. Always stop the engine and do not smoke or allow open flames or sparks in the area while filling fuel tanks.

Fill fuel tanks outdoors away from heat, sparks, and open flames.

Always stop engine before refilling tanks.

Do not completely fill the fuel tanks. Leave approximately 10% of the tank volume unfilled. Fuel will expand in volume as its temperature rises and can leak under pressure if the tank is completely filled.

FILLING FUEL TANKS PERMANENTLY INSTALLED

Slowly pour the correct amount of oil along with gasoline as the tank is being filled.

FILLING PORTABLE FUEL TANKS

Remove the portable fuel tanks from the boat to refill them.

Pour the full amount of oil, along with one gallon of gasoline, into the fuel tank. Mix thoroughly, then pour the remainder of gasoline into the tank.

PORTABLE FUEL TANK PLACEMENT IN THE BOAT

Place the fuel tank in the boat so the vent is higher than the fuel level under normal boat operating conditions.

FEATURES AND CONTROLS

Tiller Handle Models

- Tiller handle - Handle can be tilted 100° for convenient handling during transportation and storage.

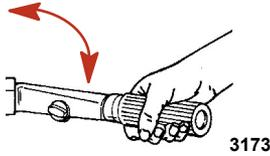

- Starter rope - Pulling the starter rope cranks the engine over for starting.

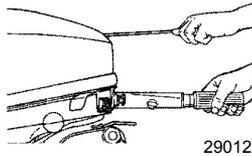

- Primer/idle speed knob - Pulling the knob out supplies a small amount of fuel to the engine for cold starting. Rotate knob to adjust idle speed after engine warms up.

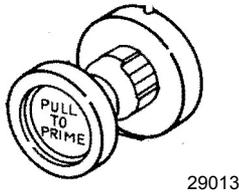

- Lanyard/Lanyard stop switch - Refer to **General Information - Lanyard Stop Switch**.

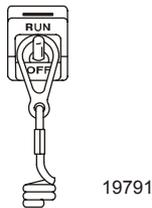

FEATURES AND CONTROLS

- Engine stop switch - Push in to stop engine.

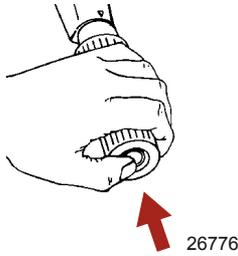

- Throttle grip friction knob - Turn friction knob to set and maintain the throttle at desired speed. Turn knob clockwise to tighten friction or turn knob counterclockwise to loosen friction.

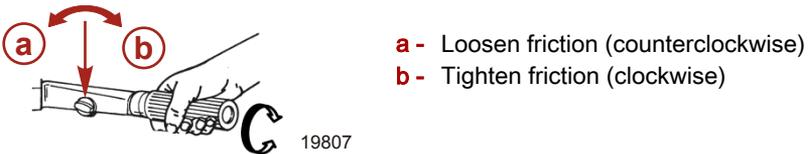

- Throttle grip gear shift (if equipped) - Controls gear shift and engine speed.

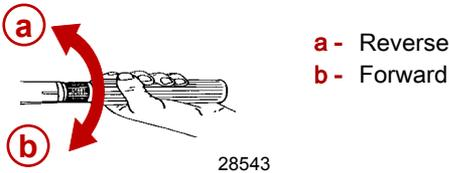

- Side handle gear shift (if equipped) - Controls gear shift.

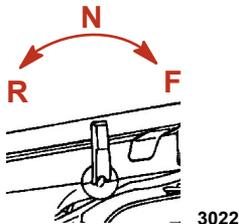

NOTE: Side handle gear shift outboards are furnished in some worldwide market areas. Side handle gear shift is also available as a Quicksilver or Mercury Precision Accessory.

FEATURES AND CONTROLS

- Throttle grip (side handle gear shift models) - Controls engine speed.

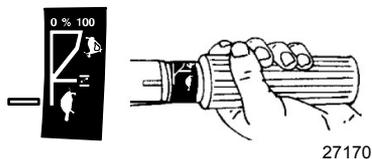

- Electric start button (electric start models) - Press button to start engine.

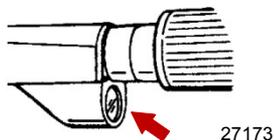

⚠ WARNING

Insufficient friction adjustment can cause serious injury or death due to loss of boat control. When setting the friction adjustment, maintain sufficient steering friction to prevent the outboard from steering into a full turn if the tiller handle or steering wheel is released.

- Steering friction adjustment - Adjust this lever to achieve the desired steering friction (drag) on the tiller handle. Move lever to the left to tighten, or move lever to the right to loosen.

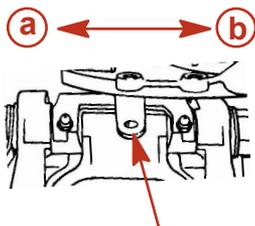

- a** - Tighten friction
- b** - Loosen friction

Remote Control Models - Manual Start

- Starter rope - Pulling the starter rope cranks the engine over for starting.

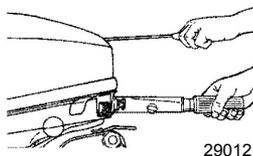

FEATURES AND CONTROLS

- Primer/idle speed knob - Pulling the knob out supplies a small amount of fuel to the engine for cold starting. Rotate knob to adjust idle speed after engine warms up.



29013

- Control handle - Controls gear shift and engine speed.

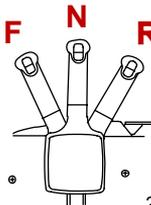

27237

- Lanyard/Lanyard stop switch - Refer to **General Information - Lanyard Stop Switch**.



19791

- Throttle friction adjustment - Adjust to maintain desired tension at the control handle.

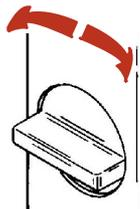

3024

FEATURES AND CONTROLS

- Neutral release lever - Pull this lever up to move the control handle out of neutral position.

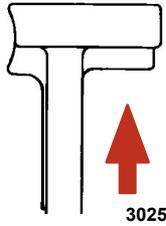

- Engine on/off switch - Turns engine on and off.



Remote Control Models - Electric Start

- Control handle - Controls gear shift and engine speed.

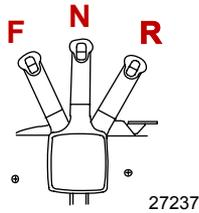

- Lanyard/Lanyard stop switch - Refer to **General Information - Lanyard Stop Switch**.

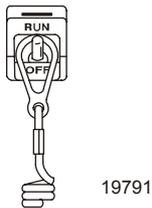

FEATURES AND CONTROLS

- Throttle friction adjustment - Adjust to maintain desired tension at the control handle.

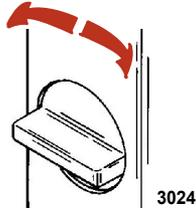

- Ignition key switch - Turn the key switch for starting and stopping the engine. Push in on key switch to choke the engine.

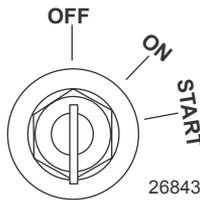

- Neutral release lever - Pull this lever up to move the control handle out of neutral position.

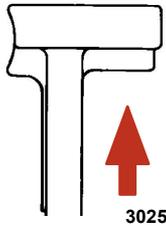

- Fast idle lever - Raising lever will increase engine idle speed in neutral. Refer to **Operation - Starting The Engine**.

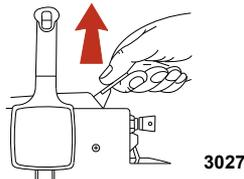

Tilting Outboard

1. Stop the engine. Shift the outboard into the forward gear position.
2. Take hold of the top cowl grip and raise the outboard to the full up position.

FEATURES AND CONTROLS

3. Pull out on the tilt lock knob and move it to the lock position. The outboard cannot be lowered while the tilt lock knob is in the lock position.
4. To lower the engine, move the tilt lock knob to the unlock position.
5. Raise the outboard to the tilt release position and gently lower the outboard to the preset trim position.

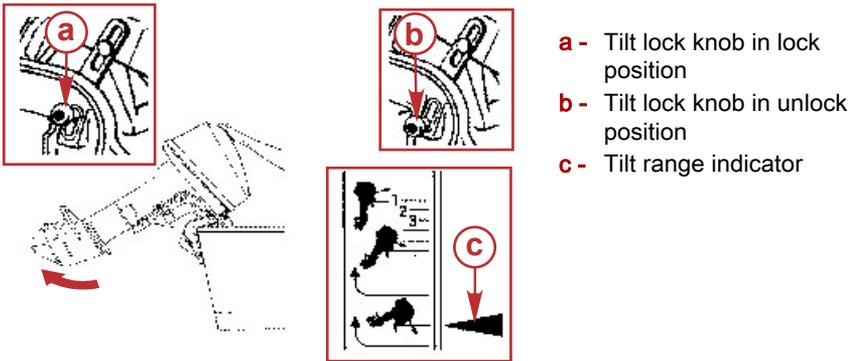

28587

Shallow Water Operation

There are three (3) shallow water drive positions that enable the outboard to be tilted up to prevent hitting the bottom.

1. Reduce engine speed to idle.
2. Shift outboard to neutral or forward gear position.

IMPORTANT: Operate outboard at slow speed for shallow water operation and keep the water intake submerged.

FEATURES AND CONTROLS

3. Tilt outboard up to one of the shallow water drive positions.

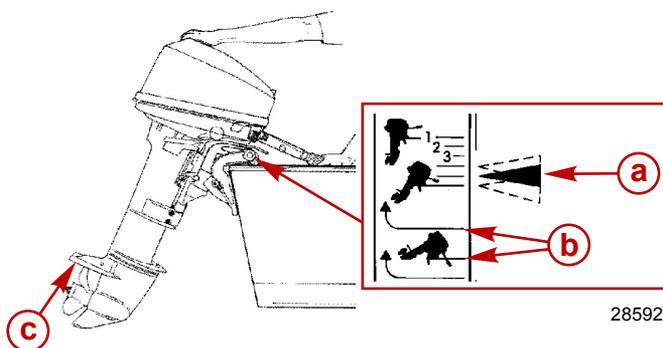

28592

- a - Shallow water drive positions
- b - Tilt release positions
- c - Water Intake

4. Ensure the water intake is submerged.
5. To release the shallow water drive, stop engine and tilt outboard up to one of the tilt release position.
6. Gently lower the outboard to the preset transom angle.

Setting The Transom Angle Of Your Outboard

The vertical transom angle of your outboard is adjusted by changing the position of the preset tilt knob in one of the three adjustment holes provided. Proper adjustment allows the boat to achieve optimum performance, stability, and minimize steering effort.

NOTE: Refer to the following lists when adjusting the transom angle of your outboard.

The preset tilt knob should be adjusted so the outboard is positioned to run perpendicular to the water when the boat is running at full speed. This allows the boat to be driven parallel to the water.

FEATURES AND CONTROLS

Arrange passengers and load in the boat so the weight is distributed evenly.

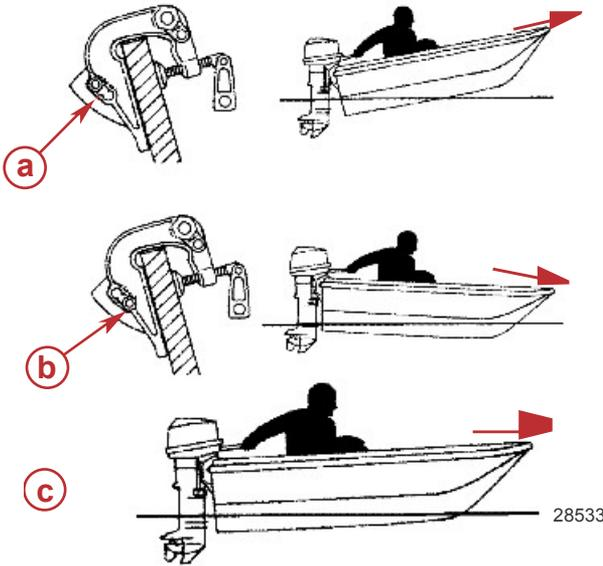

- a** - Too much angle (stern down - bow up)
- b** - Not enough angle (stern up - bow down)
- c** - Angle adjusted properly (bow slightly up)

Consider the following lists carefully when adjusting the operating angle of your outboard.

Adjusting the outboard close to the boat transom can:

- Lower the bow.
- Result in quicker planing off, especially with a heavy load or a stern heavy boat.
- Generally improve the ride in choppy water.
- Increase steering torque or pull to the right.
- In excess can lower the bow of some boats to a point where they begin to plow with their bow in the water while on plane. This can result in an unexpected turn in either direction (called bow steering or over-steering) if any turn is attempted or if a significant wave is encountered.

Adjusting the outboard away from the boat transom can:

- Lift the bow out of the water.
- Generally increase top speed.
- Increase clearance over submerged objects or a shallow bottom.
- Increase steering torque or pull to the left at a normal installation height.

FEATURES AND CONTROLS

- In excess can cause boat porpoising (bouncing) or propeller ventilation.

Adjusting Transom Angle

1. Stop the engine. Shift the outboard into forward. Raise the engine to one of the tilt release positions. Change the preset knob position and lower the outboard to the preset transom angle position.
2. Repeat step number one if the transom angle needs further adjustment.

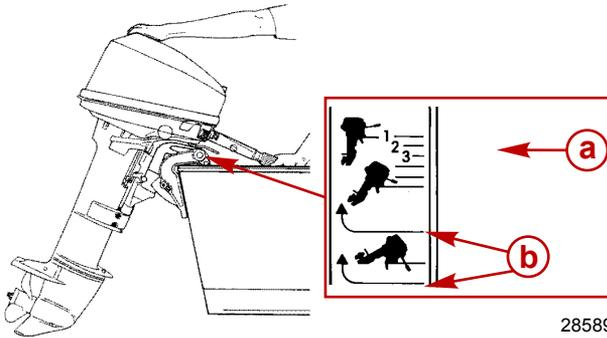

28589

- a** - Transom angle settings
- b** - Tilt release position

OPERATION

Prestarting Check List

- Operator knows safe navigation, boating, and operating procedures.
- An approved personal flotation device of suitable size for each person aboard and readily accessible (it is the law).
- A ring type life buoy or buoyant cushion designed to be thrown to a person in the water.
- Know your boats' maximum load capacity. Look at the boat capacity plate.
- Fuel supply OK.
- Arrange passengers and load in the boat so the weight is distributed evenly and everyone is seated in a proper seat.
- Tell someone where you are going and when you expect to return.
- It is illegal to operate a boat while under the influence of alcohol or drugs.
- Know the waters and area you will be boating; tides, currents, sand bars, rocks, and other hazards.
- Make inspection checks listed in **Maintenance - Inspection and Maintenance Schedule**.

Operating in Freezing Temperatures

When using your outboard or having your outboard moored in freezing or near freezing temperatures, keep the outboard tilted down at all times so the gearcase is submerged. This prevents the trapped water in the gearcase from freezing and causing possible damage to the water pump and other components.

If there is a chance of ice forming on the water, the outboard should be removed and drained completely of water. If ice should form at the water level inside the outboard driveshaft housing, it will block water flow to the engine causing possible damage.

Operating in Saltwater or Polluted Water

We recommend that you flush the internal water passages of your outboard with fresh water after each use in salt or polluted water. This will prevent a buildup of deposits from clogging the water passages. Refer to **Maintenance - Flushing the Cooling System**.

If you keep your boat moored in the water, always tilt the outboard so the gearcase is completely out of water (except in freezing temperatures) when not in use.

Wash the outboard exterior and flush out the exhaust outlet of the propeller and gearcase with fresh water after each use. Each month, spray Mercury Precision or Quicksilver Corrosion Guard on external metal surfaces. Do not spray on corrosion control anodes as this will reduce the effectiveness of the anodes.

OPERATION

Operating at High Elevations

IMPORTANT: To prevent serious damage to the engine caused by a lean fuel mixture, do not operate your outboard (if the jets were changed for high elevation) at a lower elevation unless the jets are changed again to correspond to the new elevation.

Operating your outboard at an elevation higher than 750 m (2500 ft) above sea level may require a carburetor jet change and/or different pitch propeller. Consult your dealer. This will reduce the normal performance loss experienced as a result of reduced oxygen in the air causing an overly rich fuel mixture.

Operating Outboard as an Auxiliary Engine

If the outboard is used as an auxiliary engine, stop the engine and tilt the outboard out of the water when using the main power source.

IMPORTANT: The outboard must be restrained from bouncing while operating the boat using the main power source. Bouncing can damage the outboard and boat transom.

Prestarting Instructions

1. Connect the remote fuel line to the outboard. Make sure connector is snapped into place.

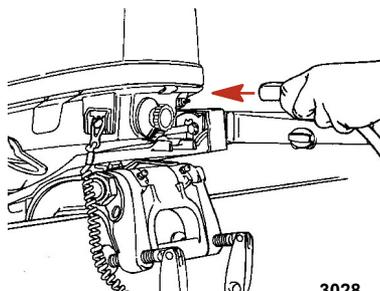

3028

NOTICE

Without sufficient cooling water, the engine, the water pump, and other components will overheat and suffer damage. Provide a sufficient supply of water to the water inlets during operation.

OPERATION

2. Make sure the cooling water intake is submerged.

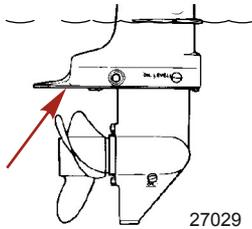

Engine Break-in Procedure

IMPORTANT: Failure to follow the engine break-in procedures can result in poor performance throughout the life of the engine and can cause engine damage. Always follow break-in procedures.

ENGINE BREAK-IN FUEL MIXTURE

Use a 25:1 (4%) gasoline/oil mixture in the first tank of fuel.

BREAK-IN PROCEDURE

Vary the throttle setting during the first hour of operation. During the first hour of operation, avoid remaining at a constant speed for more than two minutes and avoid sustained wide open throttle.

Starting the Engine - Tiller Handle Models and Manual Start Remote Control Models

Before starting, read the **Prestarting Check List**, special operating instructions, and **Engine Break-in Procedure** in the **Operation** section.

1. Open fuel tank vent on manual venting type tanks.

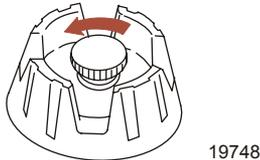

2. Squeeze the fuel line primer bulb several times until it feels firm.

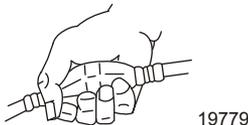

OPERATION

3. Set the lanyard stop switch to RUN position. Refer to **General Information - Lanyard Stop Switch**.

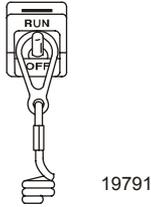

4. Set the throttle grip to start position.

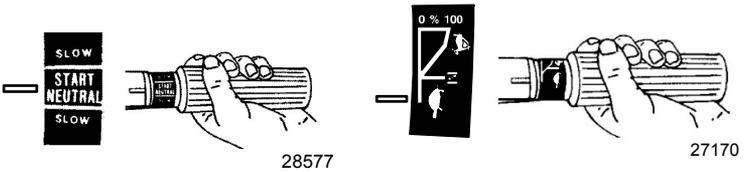

Throttle grip gear shift models

Side handle gear shift models

5. Remote control models - Move on/off switch to the on position.



6. Side handle gear shift and remote control models - Set the gear shift to neutral position.

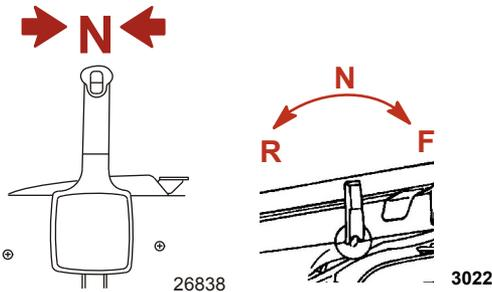

IMPORTANT: Outboards with battery charging capabilities must not be operated with battery cables disconnected from the battery. Damage to the charging system may result.

OPERATION

7. Turn primer/idle speed knob full clockwise to increase engine idle speed.

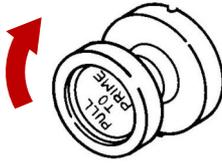

29026

8. Cold Engine - Pull out and push in the primer/idle speed knob one to three times to prime the engine. Leave the knob in the pulled out position when starting.



29013

9. Manual Starting Models - Pull the starter rope slowly until starter engages, then pull rapidly to crank the engine. Allow rope to return slowly. Repeat until engine starts.

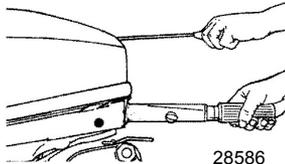

28586

10. Electric Starting Models - Push starter button and crank the engine. Release button when engine starts. Do not operate starter motor continuously for longer than ten seconds at a time. If engine fails to start, wait 30 seconds and try again.

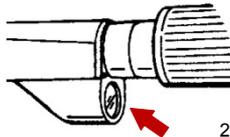

27173

OPERATION

11. Push in the primer/idle speed knob after engine starts. If engine begins to stall, reprime until engine is running smoothly.

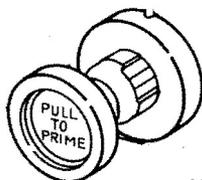

29013

NOTE: Starting flooded engine - Push in the primer/idle speed knob and turn full clockwise. Continue to crank the engine for starting.

12. Turn the primer/idle speed knob counterclockwise to obtain desired idle speed as engine warms up.

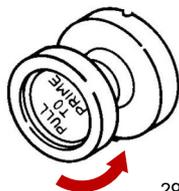

29048

13. Check for a steady stream of water flowing out of the water pump indicator hole.

NOTE: Engines equipped with a thermostat - The amount of water flow can vary due to the thermostat operation. It may take several minutes for the engine to warm up enough for water to start spraying out of the indicator hole.

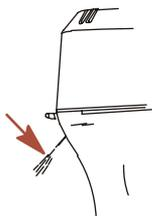

19805

IMPORTANT: If no water is coming out of the water pump indicator hole, stop engine and check cooling water intake for obstruction. No obstruction may indicate a water pump failure or blockage in the cooling system. These conditions will cause the engine to overheat. Have the outboard checked by your dealer. Operating the engine while overheated will cause serious engine damage.

Starting the Engine - Electric Start Remote Control Models

Before starting, read the **Prestarting Check List**, special operating instructions, and **Engine Break-in Procedure** in the **Operation** section.

OPERATION

1. Open fuel tank vent on manual venting type tanks.

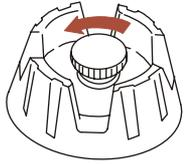

19748

2. Squeeze the fuel line primer bulb several times until it feels firm.

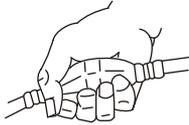

19779

3. Set the lanyard stop switch to RUN position. Refer to **General Information - Lanyard Stop Switch**.



19791

4. Set the remote control handle to neutral position.

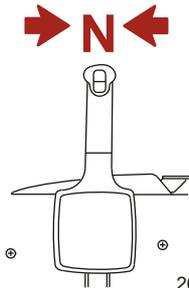

26838

OPERATION

5. Cold Temperature - It may be helpful to prime the engine 1 to 3 times using the manual primer knob before starting.



29013

IMPORTANT: Electric starting outboard models must not be started manually using the starter rope, or run, without having the battery leads connected to a battery. Damage to the charging system could result.

6. Cold Engine - Do not advance the neutral fast idle speed feature on the remote control for initial starting. After engine has started, slowly advance the fast idle speed feature to increase idle speed until engine is warmed up. Keep engine speed below 2000 RPM.

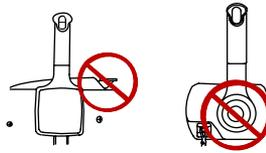

27242

7. Warm Engine - Advance the fast idle lever or throttle only feature to an approximate halfway (1/2) setting. After engine starts, immediately reduce engine speed back to idle.

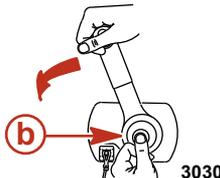
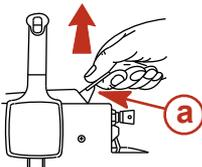

- a - Fast idle speed lever
- b - Throttle only feature

3030

8. Starting Flooded Engine - Advance the fast idle lever or throttle only feature to the maximum position. Without activating primer, crank engine for 10 seconds. Wait 30 seconds and repeat until engine starts. Immediately start to reduce engine speed after engine starts.

OPERATION

9. Turn ignition key to the START position. If engine is cold, push in on key to choke engine. If engine fails to start in 10 seconds, return key to ON position, wait 30 seconds and try again.

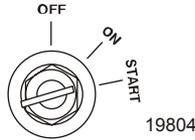

10. Check for a steady stream of water flowing out of the water pump indicator hole.

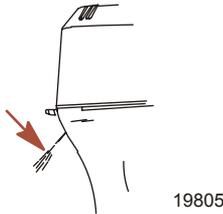

NOTE: Engines equipped with a thermostat - The amount of water flow can vary due to the thermostat operation. It may take several minutes for the engine to warm up enough for water to start spraying out of the indicator hole.

IMPORTANT: If no water is coming out of the water pump indicator hole, stop engine and check cooling water intake for obstruction. No obstruction may indicate a water pump failure or blockage in the cooling system. These conditions will cause the engine to overheat. Have the outboard checked by your dealer. Operating the engine while overheated will cause serious engine damage.

Gear Shifting

IMPORTANT: Observe the following:

- **Never shift the outboard into or out of gear unless the engine speed is at idle. Shifting at higher than engine idle speed could cause damage to the gearcase.**
- **Do not shift the outboard into reverse when the forward motion of the boat is greater than a no wake speed. Shifting into reverse at higher boat speeds could cause the engine to stall, and in some situations, this could cause water to be drawn into the cylinders, resulting in severe engine damage.**
- **Do not shift the outboard into reverse when the engine is not running. Damage to the shift linkage could occur.**
- The outboard has three gear shift positions: forward (F), neutral (N), and reverse (R).
- Remote control models—always stop at the neutral position to allow the engine idle speed to stabilize before shifting into another gear.

OPERATION

- Tiller handle models—reduce the engine speed to idle before shifting into another gear.
- Always shift the outboard into gear with a quick motion.
- After shifting the outboard into gear, advance the remote control handle or rotate the throttle grip (tiller handle) to increase the engine speed.

Stopping the Engine

1. Remote Control Models - Reduce engine speed and shift outboard to neutral position. Turn ignition key or on/off switch to "OFF" position.

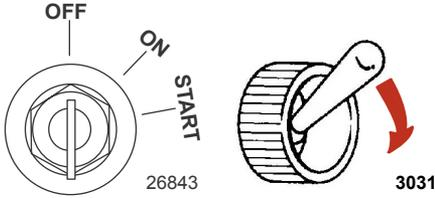

2. Tiller Handle Models - Reduce engine speed and shift outboard to neutral position. Push in the engine stop button or turn ignition key to "OFF" position.

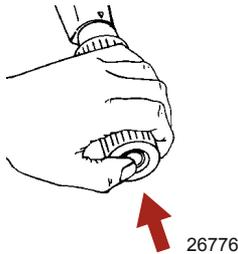

Emergency Starting

If the starter system fails, use the spare starter rope (provided) and follow procedure.

OPERATION

1. Shift outboard to neutral (N) position.

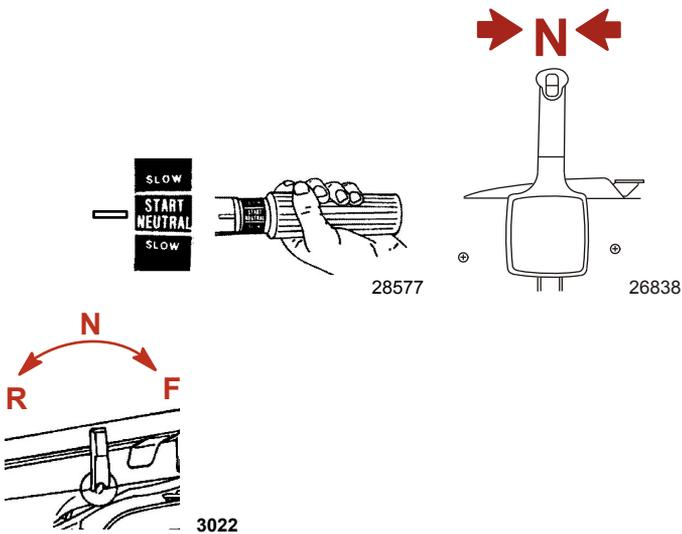

⚠ WARNING

The neutral-speed-protection device is inoperative when starting the engine with the emergency starter rope. Set the engine speed at idle and the gear shift in neutral to prevent the outboard from starting in gear.

2. Remove the fuel filter.

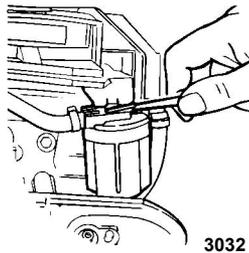

OPERATION

3. Disconnect the linkage from rewind starter assembly.

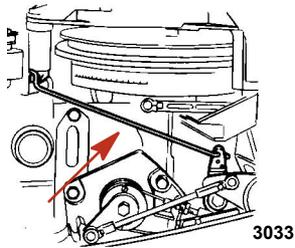

4. Remove three bolts and rewind starter assembly.

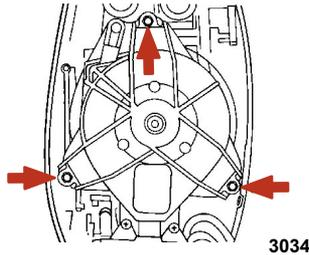

5. Remote Control Models - Turn the ignition key or on/off switch to "ON" position.

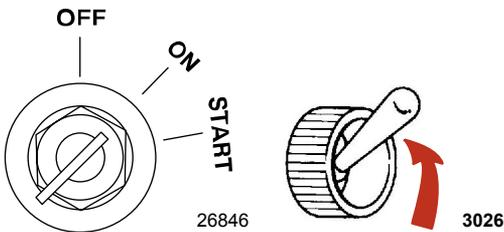

6. Set the lanyard stop switch to "RUN" position. Refer to **General Information - Lanyard Stop Switch**.

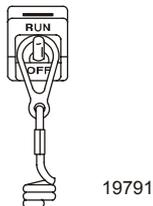

OPERATION

▲ WARNING

High voltage is present any time the key is turned on, especially when starting or operating the engine. Do not touch ignition components or metal test probes and stay clear of spark plug leads when performing live tests.

▲ WARNING

The exposed moving flywheel can cause serious injury. Keep your hands, hair, clothing, tools, and other objects away from engine when starting or running the engine. Do not attempt to reinstall the flywheel cover or top cowl when engine is running.

7. Tie one end of the spare starter rope around screwdriver tool (provided) and tie a knot in other end.
8. Place the starter rope knot into the flywheel notch and wind the rope clockwise around the flywheel.
9. Pull the starter rope to start the engine.

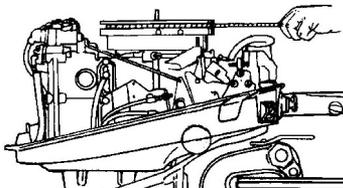

3035

MAINTENANCE

Cleaning Care Recommendations

OUTBOARD CARE

To keep your outboard in the best operating condition, it is important that your outboard receive the periodic inspections and maintenance listed in the **Inspection and Maintenance Schedule**. We urge you to keep it maintained properly to ensure the safety of you and your passengers, and retain its dependability.

Record maintenance performed in the **Maintenance Log** at the back of this book. Save all maintenance work orders and receipts.

Selecting Replacement Parts For Your Outboard

We recommend using original Mercury Precision or Quicksilver replacement parts and Genuine Lubricants.

DO NOT USE CAUSTIC CLEANING CHEMICALS

IMPORTANT: Do not use caustic cleaning chemicals on the outboard power package. Some cleaning products contain strong caustic agents such as hull cleaners with hydrochloric acid. These cleaners can degrade some of the components they come in contact with including critical steering fasteners.

Damage to steering fasteners may not be obvious during visual inspection and this damage may lead to catastrophic failure. Some caustic cleaning chemicals may cause or accelerate corrosion. Exercise caution when using cleaning chemicals around the engine and follow the recommendations on the packaging of the cleaning product.

CLEANING GAUGES

IMPORTANT: Never use high-pressure water to clean gauges.

Routine cleaning of the gauges is recommended to prevent a buildup of salt and other environmental debris. Crystallized salt can scratch the gauge display lens when using a dry or damp cloth. Ensure that the cloth has a sufficient amount of fresh water to dissolve and remove salt or mineral deposits. Do not apply aggressive pressure on the display lens while cleaning.

When water marks cannot be removed with a damp cloth, mix a 50/50 solution of warm water and isopropyl alcohol to clean the display lens. **Do not use** acetone, mineral spirits, turpentine type solvents, or ammonia based cleaning products. The use of strong solvents or detergents may damage the coating, the plastics, or the rubber keys on the gauges. If the gauge has a sun cover available, it is recommended that the cover be installed when the unit is not in use to prevent UV damage to the plastic bezels and rubber keys.

CLEANING REMOTE CONTROLS

IMPORTANT: Never use high-pressure water to clean remote controls.

MAINTENANCE

Routine cleaning of the remote control external surfaces is recommended to prevent a buildup of salt and other environmental debris. Use a cloth towel which has a sufficient amount of fresh water to dissolve and remove salt or mineral deposits.

When water marks cannot be removed with a damp cloth, mix a 50/50 solution of warm water and isopropyl alcohol to clean the remote control. **Do not use acetone, mineral spirits, turpentine type solvents, or ammonia based cleaning products.** The use of strong solvents or detergents may damage the coating, the plastics, or the rubber components on the remote control.

CLEANING CARE FOR TOP AND BOTTOM COWLS

IMPORTANT: Dry wiping (wiping the plastic surface when it is dry) will result in minor surface scratches. Always wet the surface before cleaning. Do not use detergents containing hydrochloric acid. Follow the cleaning and waxing procedure.

Cleaning and Waxing Procedure

1. Before washing, rinse the cowls with clean water to remove dirt and dust that may scratch the surface.
2. Wash the cowls with clean water and a mild nonabrasive soap. Use a soft clean cloth when washing.
3. Dry thoroughly with a soft clean cloth.
4. Wax the surface using a nonabrasive automotive polish (polish designed for clear coat finishes). Remove the applied wax by hand using a clean soft cloth.
5. To remove minor scratches, use Mercury Marine Cowl Finishing Compound (92-859026K 1).

CLEANING CARE FOR THE POWERHEAD (SALTWATER USE)

If the outboard is operated in saltwater, remove the top cowl and flywheel cover. Inspect the powerhead and powerhead components for salt buildup. Wash off any salt buildup from the powerhead and powerhead components with fresh water. Keep water spray out of the air filter/intake and alternator. After washing, allow the powerhead and components to dry. Apply Quicksilver or Mercury Precision Lubricants Corrosion Guard spray on the external metal surfaces of the powerhead and powerhead components. Do not allow the Corrosion Guard spray to come in contact with the alternator drive belt or belt pulleys.

IMPORTANT: Do not allow lubricant or Corrosion Guard spray to come in contact with the alternator drive belt or the belt pulleys. The alternator drive belt could slip and be damaged if it becomes coated with any lubricant or Corrosion Guard spray.

MAINTENANCE

Tube Ref No.	Description	Where Used	Part No.
 120	Corrosion Guard	External metal surfaces of the powerhead and powerhead components.	92-802878 55

EPA Regulations

All new outboards manufactured by Mercury Marine are certified to the United States Environmental Protection Agency, as conforming to the requirements of the regulations for the control of air pollution from new outboard motors. This certification is contingent on certain adjustments being set to factory standards. For this reason, the factory procedure for servicing the product must be strictly followed and, wherever practicable, returned to the original intent of the design. **Maintenance, replacement, or repair of the emission control devices and systems may be performed by any marine spark ignition (SI) engine repair establishment or individual.**

EPA Emissions

EMISSION CERTIFICATION LABEL

An emission certification label, showing emission levels and engine specifications directly related to emissions, is placed on the engine at time of manufacture.

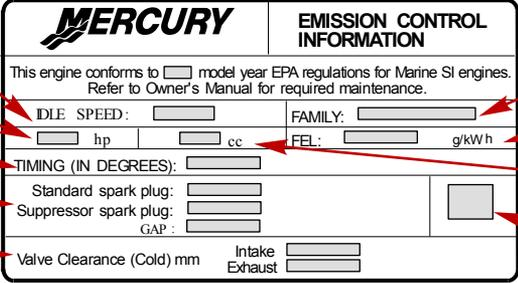

MERCURY EMISSION CONTROL INFORMATION

This engine conforms to model year EPA regulations for Marine SI engines. Refer to Owner's Manual for required maintenance.

IDLE SPEED: FAMILY:

hp cc FEL: g/kWh

TIMING (IN DEGREES):

Standard spark plug:

Suppressor spark plug:

GAP:

Valve Clearance (Cold) mm Intake Exhaust

28405

- a** - Idle speed
- b** - Engine horsepower
- c** - Timing specification
- d** - Recommended spark plug and gap
- e** - Valve clearance (if applicable)
- f** - US EPA engine family name
- g** - Maximum emission output for the engine family
- h** - Piston displacement
- i** - Date of manufacture

MAINTENANCE

OWNER RESPONSIBILITY

The owner/operator is required to have routine engine maintenance performed to maintain emission levels within prescribed certification standards.

The owner/operator is not to modify the engine in any manner that would alter the horsepower or allow emission levels to exceed their predetermined factory specifications.

Inspection and Maintenance Schedule

DAILY CHECKS

- Check the engine oil level
- Check the lanyard stop switch
- Inspect the fuel system for leaks
- Inspect the engine tightness on the transom
- Check the steering system for binding
- Check the propeller for damage
- Inspect the hydraulic steering fittings and hoses for leaks or signs of damage, if equipped
- Check the hydraulic steering fluid level, if equipped

AFTER EACH USE

- Wash the power package exterior with fresh water
- Flush the outboard cooling system, saltwater or brackish water only

ANNUALLY OR 100 HOURS

- Grease the engine, if applicable
- Change the engine oil and filter, if equipped
- Inspect the thermostat, saltwater or brackish water only
- Add Quickleen to the fuel tank, once per year, per engine
- Apply anti-seize to the spark plug threads
- Replace the gear lubricant
- Inspect the corrosion control anodes
- Lubricate the propeller shaft splines
- Replace all filters on the suction side of the fuel system—dealer item
- Lubricate the driveshaft splines—dealer item
- Check the tightness on all the fasteners—dealer item
- Check the torque of the outboard mounting hardware—dealer item
- Check the battery condition and tightness of the battery cable connection—dealer item

THREE YEARS OR 300 HOURS

- Replace the spark plugs

MAINTENANCE

- Replace the water pump impeller—dealer item
- Inspect the carbon fiber reeds—dealer item
- Inspect the wire harness connectors—dealer item
- Check the remote control cable adjustment, if applicable—dealer item
- Replace the high-pressure fuel filter—dealer item
- Replace the accessory drive belt—dealer item
- Check the power trim fluid level—dealer item
- Inspect the engine motor mounts—dealer item

Flushing The Cooling System

Flush the internal water passages of the outboard with fresh water after each use in salt, polluted, or muddy water. This will help prevent a buildup of deposits from clogging the internal water passages.

Use a Mercury Precision or Quicksilver accessory (or equivalent) flushing attachment.

⚠ WARNING

Rotating propellers can cause serious injury or death. Never operate the boat out of the water with a propeller installed. Before installing or removing a propeller, place the drive unit in neutral and engage the lanyard stop switch to prevent the engine from starting. Place a block of wood between the propeller blade and the anti-ventilation plate.

1. Remove propeller. Refer to **Propeller Replacement**. Install the flushing attachment so the rubber cup fits tightly over the cooling water intake.
2. Attach a water hose to the flushing attachment. Turn on the water and adjust the flow so water is leaking around the rubber cup to ensure the engine receives an adequate supply of cooling water.

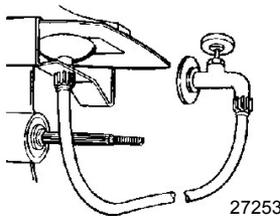

3. Start the engine and run it at idle speed in neutral shift position.

IMPORTANT: Do not run engine above idle when flushing.

MAINTENANCE

4. Adjust water flow (if necessary) so excess water continues leaking out from around the rubber cup to ensure the engine is receiving an adequate supply of cooling water.

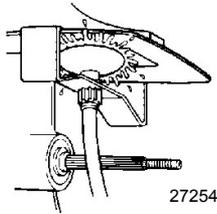

5. Check for a steady stream of water flowing out of the water pump indicator hole. Continue flushing the outboard for 3 to 5 minutes, carefully monitoring water supply at all times.
6. Stop the engine, turn off the water, and remove the flushing attachment. Reinstall the propeller.

Top Cowl Removal and Installation

REMOVAL

1. Unlock the rear latch by pushing lever down.

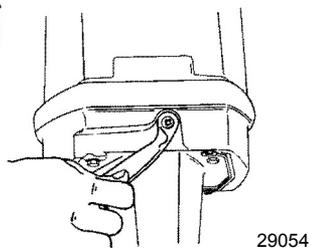

2. Lift rear of cowl and disengage front hook.

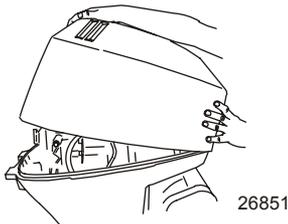

INSTALLATION

1. Engage the front hook and push cowl back over the cowl seal.
2. Push cowl down and move the rear latch lever up to lock.

MAINTENANCE

Battery Inspection

The battery should be inspected at periodic intervals to ensure proper engine starting capability.

IMPORTANT: Read the safety and maintenance instructions which accompany your battery.

1. Turn off the engine before servicing the battery.
2. Ensure the battery is secure against movement.
3. Battery cable terminals should be clean, tight, and correctly installed. Positive to positive and negative to negative.
4. Ensure the battery is equipped with a nonconductive shield to prevent accidental shorting of battery terminals.

Fuel System

▲ WARNING

Fuel is flammable and explosive. Ensure that the key switch is off and the lanyard is positioned so that the engine cannot start. Do not smoke or allow sources of spark or open flame in the area while servicing. Keep the work area well ventilated and avoid prolonged exposure to vapors. Always check for leaks before attempting to start the engine, and wipe up any spilled fuel immediately.

Before servicing any part of the fuel system, stop the engine and disconnect the battery. Drain the fuel system completely. Use an approved container to collect and store fuel. Wipe up any spillage immediately. Material used to contain spillage must be disposed of in an approved receptacle. Any fuel system service must be performed in a well-ventilated area. Inspect any completed service work for sign of fuel leakage.

FUEL LINE INSPECTION

Visually inspect the fuel line and primer bulb for cracks, swelling, leaks, hardness, or other signs of deterioration or damage. If any of these conditions are found, the fuel line or primer bulb must be replaced.

ENGINE FUEL FILTER

Inspect the sight bowl for water accumulation and inspect the filter element for sediment. Clean the filter as follows.

Removal

1. Read fuel system servicing information and Warning preceding.
2. Hold onto the cover to prevent it from turning and remove the sight bowl.

MAINTENANCE

3. Pull out the filter element and wash it with cleaning solvent.

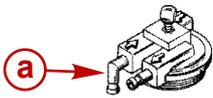
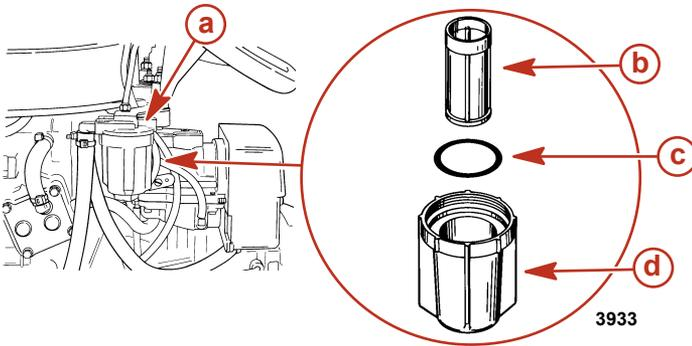

29055

- a - Cover
- b - Filter element
- c - O-ring
- d - Sight bowl

Installation

1. Push the filter element (with open end toward cover) into the cover.
2. Place the O-ring seal into the sight bowl and screw the sight bowl hand-tight into the cover.

IMPORTANT: Visually inspect for fuel leakage from the filter by squeezing the primer bulb until firm, forcing fuel into the filter.

Exterior Care

Your outboard is protected with a durable baked enamel finish. Clean and wax often using marine cleaners and waxes.

MAINTENANCE

Steering Link Rod Fasteners

IMPORTANT: The steering link rod that connects the steering cable to the engine must be fastened using special washer head bolt ("d" - Part Number 10-856680) and self-locking nylon insert locknuts ("a" & "c" - Part Number 11-826709113). These locknuts must never be replaced with common nuts (non-locking) as they will work loose and vibrate off, freeing the link rod to disengage.

⚠ WARNING

Improper fasteners or improper installation procedures can result in loosening or disengagement of the steering link rod. This can cause a sudden, unexpected loss of boat control, resulting in serious injury or death due to occupants being thrown within or out of the boat. Always use required components and follow instructions and torque procedures.

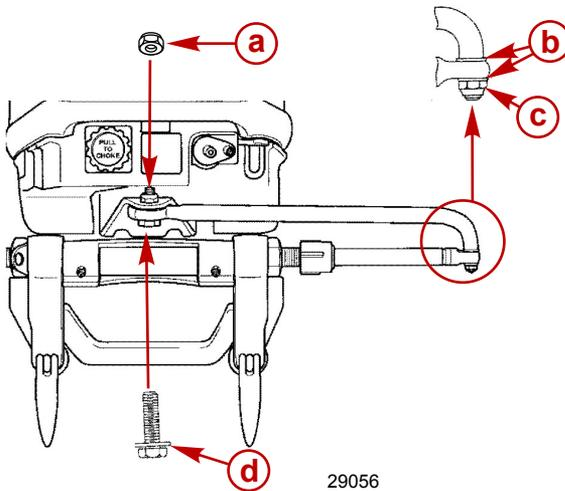

- a** - Nylon insert locknut (11-826709113)
- b** - Flat washers
- c** - Nylon insert locknut (11-826709113)
- d** - Special washer head bolt (10-856680)

Description	Nm	lb-in.	lb-ft
Special washer head bolt	27	–	20
Nylon insert locknut "a"	27	–	20
Nylon insert locknut "c"	Tighten until seats, then back off 1/4 turn		

MAINTENANCE

Assemble steering link rod to steering cable with two flat washers and nylon insert locknut. Tighten locknut until it seats, then back nut off 1/4 turn.

Assemble steering link rod to engine with special washer head bolt and locknut. First torque special washer head bolt then torque locknut to specification.

Fuse Replacement - Electric Start Remote Control Models

IMPORTANT: Always carry spare SFE 20 amp fuses.

The electric starting circuit is protected from overload by an SFE 20 amp fuse. If the fuse is blown, the electric starter motor will not operate. Try to locate and correct the cause of the overload. If the cause is not found, the fuse may blow again. Replace fuse with a fuse of the same rating.

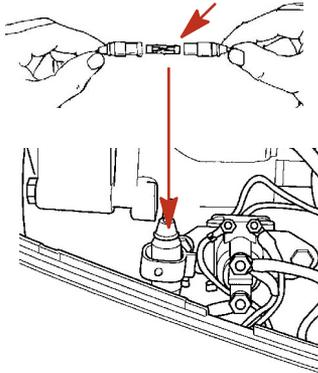

3036

Corrosion Control Anode

The outboard has a corrosion control anode installed on the gearcase. An anode helps protect the outboard against galvanic corrosion by sacrificing its metal to be slowly eroded instead of the outboard metals.

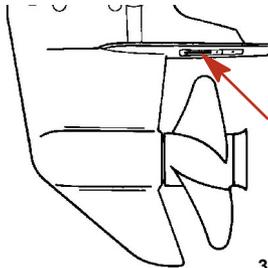

3037

The anode requires periodic inspection especially in saltwater which will accelerate the erosion. To maintain this corrosion protection, always replace the anode before it is completely eroded. Never paint or apply a protective coating on the anode as this will reduce effectiveness of the anode.

MAINTENANCE

Propeller Replacement

⚠ WARNING

Rotating propellers can cause serious injury or death. Never operate the boat out of the water with a propeller installed. Before installing or removing a propeller, place the drive unit in neutral and engage the lanyard stop switch to prevent the engine from starting. Place a block of wood between the propeller blade and the anti-ventilation plate.

1. Shift outboard to neutral (N) position.

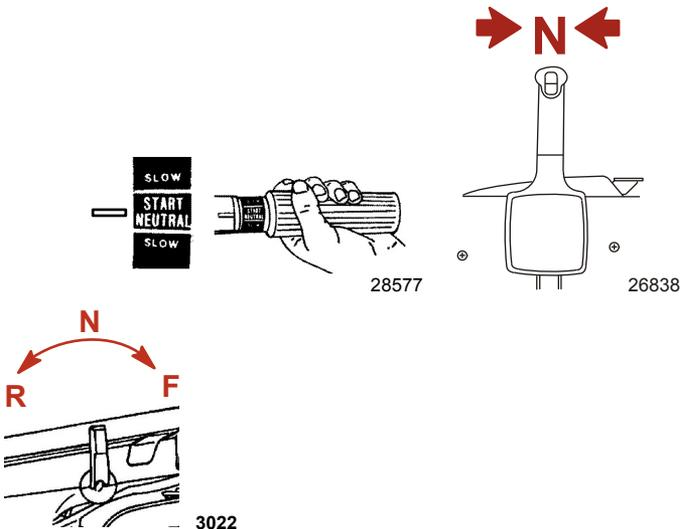

2. Remove the spark plug leads to prevent engine from starting.

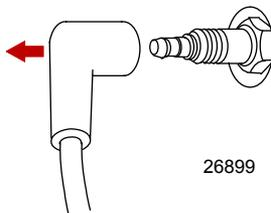

MAINTENANCE

- Place a block of wood between gearcase and propeller to hold propeller and remove propeller nut.

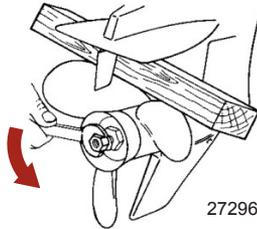

- Pull propeller straight off shaft. If propeller is seized to the shaft and cannot be removed, have the propeller removed by an authorized dealer.

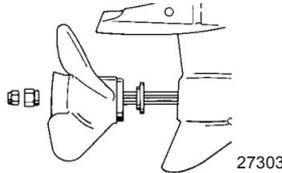

- Coat the propeller shaft with Quicksilver or Mercury Extreme Grease or 2-4-C with PTFE.

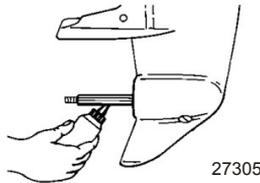

Tube Ref No.	Description	Where Used	Part No.
	Extreme Grease	Propeller shaft	8M0071842
	2-4-C with PTFE	Propeller shaft	92-802859A 1

IMPORTANT: To prevent the propeller hub from corroding and seizing to the propeller shaft (especially in saltwater), always apply a coat of the recommended lubricant to the entire propeller shaft at the recommended maintenance intervals, and also each time the propeller is removed.

MAINTENANCE

- Flo-Torq I Drive Hub Propellers - Install forward thrust hub, propeller, rear thrust hub and propeller nut onto the shaft.

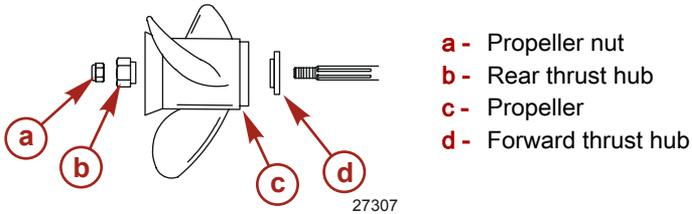

- Place a block of wood between gearcase and propeller and tighten propeller nut.

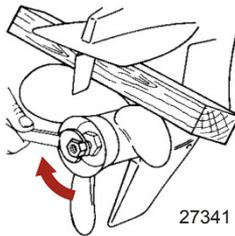

- Reinstall spark plug leads.

Spark Plug Inspection And Replacement

⚠ WARNING

Damaged spark plug boots may emit sparks that can ignite fuel vapors under the engine cowl, resulting in serious injury or death from a fire or explosion. To avoid damaging the spark plug boots, do not use any sharp object or metal tool to remove the spark plug boots.

- Remove the spark plug leads. Twist the rubber boots slightly and pull off.

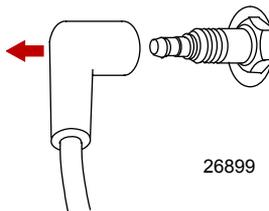

MAINTENANCE

- Remove the spark plugs to inspect. Replace spark plug if electrode is worn or the insulator is rough, cracked, broken, blistered or fouled.

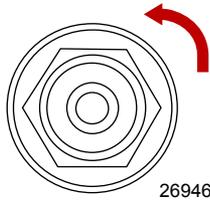

- Set the spark plug gap to specification.

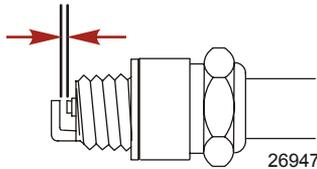

Spark Plug Gap	
NGK BPZ8HS-15	1.5 mm (0.060 in.)

- Before installing spark plugs, clean off any dirt on the spark plug seats. Install plugs finger tight, and then tighten 1/4 turn or torque to specifications.

Description	Nm	lb-in.	lb-ft
Spark plug	27	-	20

Carburetor Adjustments

SLOW SPEED MIXTURE ADJUSTMENT

- Before starting engine, turn the slow speed mixture screw in until it is lightly seated then back it out 1-1/2 turns.

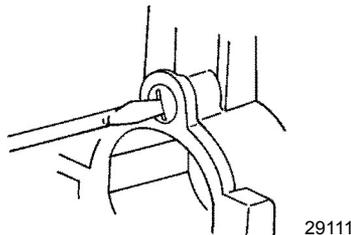

- With boat tied securely to dock, start engine and allow it to warm up.
- Shift the outboard to forward gear while maintaining idle speed.

MAINTENANCE

4. Turn the slow speed mixture screw slowly in until the engine starts to misfire or stall due to a lean mixture. Note the position of the screw slot.
5. Turn the slow speed mixture screw slowly out until the engine start to load up or fire unevenly due to a rich mixture. Note the position of the screw slot.
6. Set the slow speed mixture screw midway between the rich and lean setting. When in doubt, set the mixture slightly rich rather than too lean.

ENGINE IDLE SPEED ADJUSTMENT

1. Engines equipped with an adjustable idle speed screw:
 - a. With boat tied securely to dock, start engine and allow it to warm up.
 - b. Shift the outboard to forward gear while maintaining idle speed. Make sure the primer/fast idle knob is pushed all the way in and turned to the slowest idle speed.
 - c. Adjust the idle speed screw to obtain the recommended engine idle speed. Refer to **General Information - Specifications**.

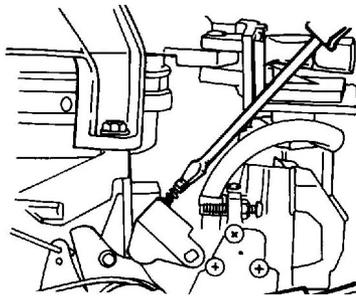

3049

2. Engines not equipped with an adjustable speed screw:
 - a. The carburetor has been calibrated for the engine to run at the recommended idle speed. The engine idle speed is not adjustable.

HIGH SPEED MIXTURE ADJUSTMENT

The carburetor is equipped with a standard size high speed fixed jet that is replaceable for operation at higher elevations.

Lubrication Points

1. Lubricate the following with Quicksilver or Mercury Precision Lubricants 2-4-C with PTFE.

MAINTENANCE

Tube Ref No.	Description	Where Used	Part No.
 95	2-4-C with PTFE	Tilt tube, transom clamp screws, swivel bracket, steering friction adjustment shaft, tilt lock pins, tilt pin tracks, shift/throttle cable, steering cable grease fitting	92-802859A 1

- Tilt Tube - Lubricate through fittings.

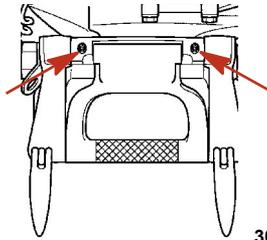

3038

- Transom Clamp Screws - Lubricate threads.

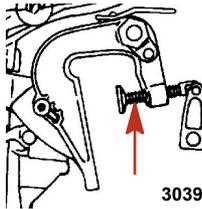

3039

- Swivel Bracket - Lubricate through fitting.
- Steering Friction Adjustment Shaft (tiller handle models) - Lubricate through fitting.

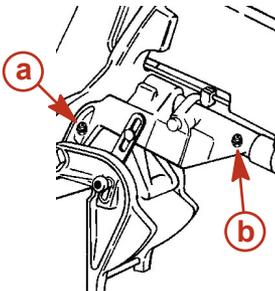

3040

a - Steering friction adjustment shaft

b - Swivel bracket

MAINTENANCE

- Tilt lock pins - Apply lubricant to pins. Pin is spring loaded. Make sure this pin is free to push in and out.

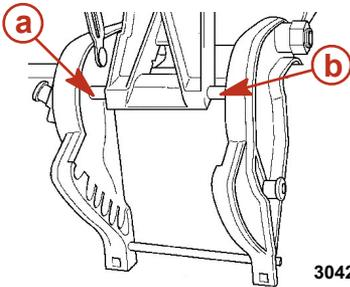

- a - Spring loaded tilt lock pin
- b - Tilt lock pin

- Lubricate along the entire tilt pin tracks.

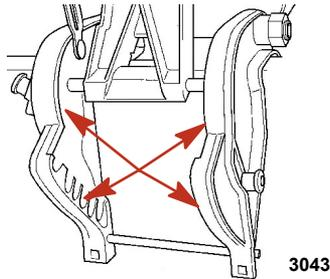

- Lubricate the throttle and shift cable moving components and pivot points.

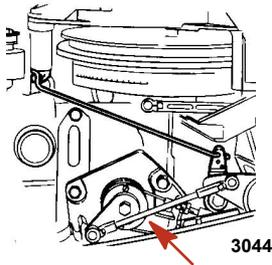

⚠ WARNING

Incorrect cable lubrication can cause hydraulic lock, leading to serious injury or death from loss of boat control. Completely retract the end of the steering cable before applying lubricant.

MAINTENANCE

- Steering Cable Grease Fitting (if equipped) - Rotate steering wheel to fully retract the steering cable end into the outboard tilt tube. Lubricate through fitting.

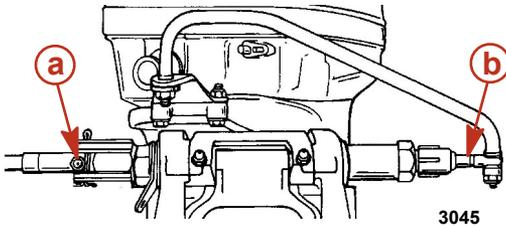

- a - Fitting
- b - Steering cable end

2. Lubricate the following with Lightweight Oil

- Steering Link Rod Pivot Points - Lubricate pivot points.

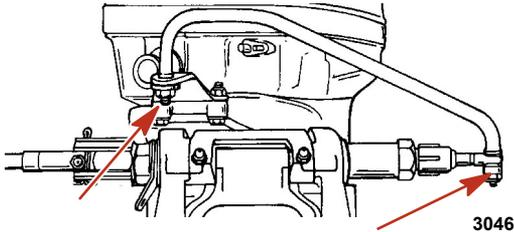

3. Lubricate the following with Quicksilver or Mercury Extreme Grease or 2-4-C with PTFE.

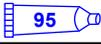
Tube Ref No.	Description	Where Used	Part No.
	Extreme Grease	Propeller shaft	8M0071842
	2-4-C with PTFE	Propeller shaft	92-802859A 1

- Propeller Shaft - Refer to **Propeller Replacement** for removal and installation of the propeller. Coat the entire propeller shaft with lubricant to prevent the propeller hub from corroding to the shaft.

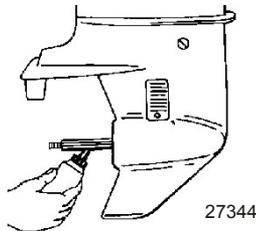

MAINTENANCE

Gearcase Lubrication

When adding or changing gearcase lubricant, visually check for the presence of water in the lubricant. If water is present, it may have settled to the bottom and will drain out prior to the lubricant, or it may be mixed with the lubricant, giving it a milky colored appearance. If water is noticed, have the gearcase checked by your dealer. Water in the lubricant may result in premature bearing failure or, in freezing temperatures, will turn to ice and damage the gearcase.

Examine the drained gearcase lubricant for metal particles. A small amount of metal particles indicates normal gear wear. An excessive amount of metal filings or larger particles (chips) may indicate abnormal gear wear and should be checked by an authorized dealer.

DRAINING GEARCASE

1. Place outboard in a vertical operating position.
2. Place drain pan below outboard.
3. Remove fill/drain plug and vent plug and drain lubricant.

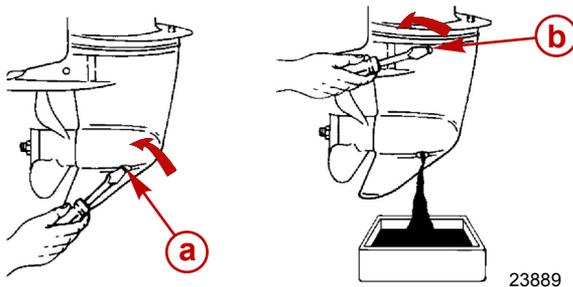

- a** - Fill/drain plug
- b** - Vent plug

GEARCASE LUBRICANT CAPACITY

Gearcase lubricant capacity is approximately 200 ml (6.8 fl oz).

GEARCASE LUBRICANT RECOMMENDATION

Mercury or Quicksilver Premium or High Performance Gear Lubricant.

CHECKING LUBRICANT LEVEL AND REFILLING GEARCASE

1. Place outboard in a vertical operating position.
2. Remove vent plug and fill/drain plug.
3. Remove fill screw and place lubricant tube into the fill hole.

MAINTENANCE

4. Add lubricant until it appears at the vent hole.

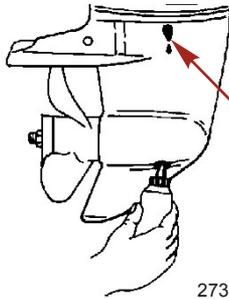

IMPORTANT: Replace sealing washers if damaged.

5. Stop adding lubricant. Install the vent plug and sealing washer before removing the lubricant tube.



6. Remove lubricant tube and reinstall cleaned fill/drain plug and sealing washer.

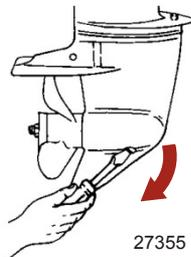

Submerged Outboard

A submerged outboard will require service within a few hours by an authorized dealer once the outboard is recovered from the water. This immediate attention by a servicing dealer is necessary once the engine is exposed to the atmosphere to minimize internal corrosion damage to the engine.

STORAGE

Storage Preparation

The major consideration in preparing your outboard for storage is to protect it from rust, corrosion, and damage caused by freezing of trapped water.

The following storage procedures should be followed to prepare your outboard for out of season storage or prolonged storage (two months or longer).

NOTICE

Without sufficient cooling water, the engine, the water pump, and other components will overheat and suffer damage. Provide a sufficient supply of water to the water inlets during operation.

FUEL SYSTEM

IMPORTANT: Gasoline containing alcohol (ethanol or methanol) can cause a formation of acid during storage and can damage the fuel system. If the gasoline being used contains alcohol, it is advisable to drain as much of the remaining gasoline as possible from the fuel tank, remote fuel line, and engine fuel system.

Fill the fuel tank and engine fuel system with treated (stabilized) fuel to help prevent formation of varnish and gum. Proceed with the following instructions.

- Portable fuel tank - Pour the required amount of gasoline stabilizer (follow instructions on container) into fuel tank. Tip fuel tank back and forth to mix stabilizer with the fuel.
- Permanently installed fuel tank - Pour the required amount of gasoline stabilizer (follow instructions on container) into a separate container and mix with approximately 1 liter (1 U.S. quart) of gasoline. Pour this mixture into fuel tank.
- Place the outboard in water or connect flushing attachment for circulating cooling water. Run the engine for ten minutes to fill the engine fuel system.

Flushing Device	91-44357Q 2
 <p>9192</p>	<p>Attaches to the water intakes; provides a fresh water connection when flushing the cooling system or operating the engine.</p>

Protecting External Outboard Components

- Lubricate all outboard components listed in **Maintenance - Inspection and Maintenance Schedule**.

STORAGE

- Touch up any paint nicks. See your dealer for touch-up paint.
- Spray Quicksilver or Mercury Precision Lubricants Corrosion Guard on external metal surfaces (except corrosion control anodes).

Tube Ref No.	Description	Where Used	Part No.
 120	Corrosion Guard	External metal surfaces	92-802878 55

Protecting Internal Engine Components

NOTE: Make sure the fuel system has been prepared for storage. Refer to **Fuel System**, preceding.

IMPORTANT: Refer to **Maintenance - Spark Plug Inspection and Replacement** for correct procedure for removing spark plug boots.

- Place the outboard in water or connect flushing attachment for circulating cooling water. Start the engine and let it run in neutral to warm up.
- With engine running at fast idle, stop the fuel flow by disconnecting the remote fuel line. When engine begins to stall, quickly spray Quicksilver or Mercury Precision Lubricants Storage Seal into carburetor until engine stops from lack of fuel.
- Remove the spark plugs and inject a five second spray of storage seal around the inside of the cylinder.
- Rotate the flywheel manually several times to distribute the storage seal in the cylinder. Reinstall spark plug.

Gearcase

- Drain and refill the gearcase lubricant (refer to **Gearcase Lubricant**).

Positioning Outboard for Storage

Store outboard in an upright (vertical) position to allow water to drain out of the outboard.

NOTICE

Storing the outboard in a tilted position can damage the outboard. Water trapped in the cooling passages or rain water collected in the propeller exhaust outlet in the gearcase can freeze. Store the outboard in the full down position.

Battery Storage

- Follow the battery manufacturer's instructions for storage and charging.
- Remove the battery from the boat and check water level. Charge if necessary.
- Store the battery in a cool, dry place.
- Periodically check the water level and charge the battery during storage.

TROUBLESHOOTING

Starter Motor Will Not Crank the Engine (Electric Start Models)

POSSIBLE CAUSES

- Remote control models - Blown 20 amp fuse in the starting circuit. Refer to **Maintenance** section.
- Outboard is not shifted to neutral position.
- Weak battery or battery connections are loose or corroded.
- Ignition key switch failure.
- Wiring or electrical connection faulty.
- Starter motor or starter solenoid failure.

Engine Will Not Start

POSSIBLE CAUSES

- Lanyard stop switch not in "RUN" position.
- Incorrect starting procedure. Refer to **Operation** section.
- Old or contaminated gasoline.
- Engine flooded. Refer to **Operation** section.
- Fuel is not reaching the engine.
 - a. Fuel tank is empty.
 - b. Fuel tank vent not open or restricted.
 - c. Fuel line is disconnected or kinked.
 - d. Primer bulb not squeezed.
 - e. Primer bulb check valve is faulty.
 - f. Fuel filter is obstructed. Refer to **Maintenance** section.
 - g. Fuel pump failure.
 - h. Fuel tank filter obstructed.
- Ignition system component failure.
- Spark plugs fouled or defective. Refer to **Maintenance** section.

Engine Runs Erratically

POSSIBLE CAUSES

- Spark plugs fouled or defective. Refer to **Maintenance** section.
- Incorrect setup and adjustments.
- Fuel is being restricted to the engine.
 - Engine fuel filter is obstructed. Refer to **Maintenance** section.
 - Fuel tank filter obstructed.
 - Stuck anti-siphon valve on built in fuel tank.
 - Fuel line is kinked or pinched.
- Fuel pump failure.

TROUBLESHOOTING

- Ignition system component failure.

Performance Loss

POSSIBLE CAUSES

- Throttle not fully open.
- Damaged or improper size propeller.
- Incorrect engine timing, adjustments, or setup.
- Boat overloaded or load improperly distributed.
- Excessive water in bilge.
- Boat bottom is dirty or damaged.

Battery Will Not Hold Charge

POSSIBLE CAUSES

- Battery connections are loose or corroded.
- Low electrolyte level in battery.
- Worn out or inefficient battery.
- Excessive use of electrical accessories.
- Defective rectifier, alternator, or voltage regulator.

OWNER SERVICE ASSISTANCE

Service Assistance

LOCAL REPAIR SERVICE

If you need service for your Mercury-outboard-powered boat, take it to your authorized dealer. Only authorized dealers specialize in Mercury products and have factory-trained mechanics, special tools and equipment, and genuine Quicksilver parts and accessories to properly service your engine.

NOTE: *Quicksilver parts and accessories are engineered and built by Mercury Marine specifically for your power package.*

SERVICE AWAY FROM HOME

If you are away from your local dealer and the need arises for service, contact the nearest authorized dealer. If, for any reason, you cannot obtain service, contact the nearest Regional Service Center. Outside the United States and Canada, contact the nearest Marine Power International Service Center.

STOLEN POWER PACKAGE

If your power package is stolen, immediately advise the local authorities and Mercury Marine of the model and serial numbers and to whom the recovery is to be reported. This information is maintained in a database at Mercury Marine to aid authorities and dealers in the recovery of stolen power packages.

ATTENTION REQUIRED AFTER SUBMERSION

1. Before recovery, contact an authorized Mercury dealer.
2. After recovery, immediate service by an authorized Mercury dealer is required to reduce the possibility of serious engine damage.

REPLACEMENT SERVICE PARTS

WARNING

Avoid fire or explosion hazard. Electrical, ignition, and fuel system components on Mercury Marine products comply with federal and international standards to minimize risk of fire or explosion. Do not use replacement electrical or fuel system components that do not comply with these standards. When servicing the electrical and fuel systems, properly install and tighten all components.

Marine engines are expected to operate at or near full throttle for most of their lives. They are also expected to operate in both fresh and saltwater environments. These conditions require numerous special parts.

PARTS AND ACCESSORIES INQUIRIES

Direct any inquiries concerning genuine Mercury Precision Parts® or Quicksilver Marine Parts and Accessories® to a local authorized dealer. Dealers have the proper systems to order parts and accessories, if they are not in stock. **Engine model** and **serial number** are required to order correct parts.

OWNER SERVICE ASSISTANCE

RESOLVING A PROBLEM

Satisfaction with your Mercury product is important to your dealer and to us. If you ever have a problem, question or concern about your power package, contact your dealer or any authorized Mercury dealership. If you need additional assistance:

1. Talk with the dealership's sales manager or service manager.
2. If your question, concern, or problem cannot be resolved by your dealership, please contact the Mercury Marine Service Office for assistance. Mercury Marine will work with you and your dealership to resolve all problems.

The following information will be needed by the Customer Service:

- Your name and address
- Your daytime telephone number
- The model and serial numbers of your power package
- The name and address of your dealership
- The nature of the problem

CONTACT INFORMATION FOR MERCURY MARINE CUSTOMER SERVICE

For assistance, call, fax, or write to the geographic office in your area. Please include your daytime telephone number with mail and fax correspondence.

United States, Canada		
Telephone	English +1 920 929 5040 Français +1 905 636 4751	Mercury Marine W6250 Pioneer Road P.O. Box 1939 Fond du Lac, WI 54936-1939
Fax	English +1 920 929 5893 Français +1 905 636 1704	
Website	www.mercurymarine.com	

Australia, Pacific		
Telephone	+61 3 9791 5822	Brunswick Asia Pacific Group 41-71 Bessemer Drive Dandenong South, Victoria 3175 Australia
Fax	+61 3 9706 7228	

Europe, Middle East, Africa		
Telephone	+32 87 32 32 11	Brunswick Marine Europe Parc Industriel de Petit-Rechain B-4800 Verviers, Belgium
Fax	+32 87 31 19 65	

OWNER SERVICE ASSISTANCE

Mexico, Central America, South America, Caribbean		
Telephone	+1 954 744 3500	Mercury Marine 11650 Interchange Circle North Miramar, FL 33025 U.S.A.
Fax	+1 954 744 3535	

Japan		
Telephone	+072 233 8888	Kisaka Co., Ltd. 4-130 Kannabecho, Sakai-ku Sakai-shi, Osaka 590-0984, Japan
Fax	+072 233 8833	

Asia, Singapore		
Telephone	+65 65466160	Brunswick Asia Pacific Group T/A Mercury Marine Singapore Pte Ltd 29 Loyang Drive Singapore, 508944
Fax	+65 65467789	

Ordering Literature

Before ordering literature, have the following information about your power package available:

Model		Serial Number	
Horsepower		Year	

UNITED STATES AND CANADA

For additional literature for your Mercury Marine power package, contact your nearest Mercury Marine dealer or contact:

Mercury Marine		
Telephone	Fax	Mail
(920) 929-5110 (USA only)	(920) 929-4894 (USA only)	Mercury Marine Attn: Publications Department P.O. Box 1939 Fond du Lac, WI 54936-1939

OUTSIDE THE UNITED STATES AND CANADA

Contact your nearest Mercury Marine authorized service center to order additional literature that is available for your particular power package.

OWNER SERVICE ASSISTANCE

Submit the following order form with payment to:	Mercury Marine Attn: Publications Department W6250 Pioneer Road P.O. Box 1939 Fond du Lac, WI 54936-1939
--------------------------------------------------	----------------------------------------------------------------------------------------------------------------------

Ship To: (Copy this form and print or type—This is your shipping label)	
Name	
Address	
City, State, Province	
ZIP or postal code	
Country	

Quantity	Item	Stock Number	Price	Total
			.	.
			.	.
			.	.
			.	.
			.	.
Total Due			.	.

INSTALLATION

Mercury Marine Validated Engine Mounting Hardware

IMPORTANT: Mercury Marine provides validated fasteners and installation instructions, including torque specifications, with all of our outboards so they can be properly secured to boat transoms. Improper installation of the outboard can cause performance and reliability issues that can lead to safety concerns. Follow all of the instructions relating to the outboard installation. **DO NOT** mount any other accessory onto the boat with the fasteners provided with the outboard. For example, do not mount tow sport bars or boarding ladders onto the boat using the mounting hardware included with the outboard. Installing other products onto the boat that utilize the outboard mounting hardware will compromise the ability of that hardware to properly and safely secure the outboard to the transom.

Outboards that require validated mounting hardware will have the following decal on the transom clamp.



51965

Installing Outboard

NOTE: If outboard is a remote control electric start model, follow instructions in the outboard installation manual (provided with the outboard) for installing remote steering shift and throttle cables and remote wiring harness.

INSTALLATION

BOAT TRANSOM HEIGHT REQUIREMENT

1. Measure the transom height of your boat. The boat bottom should be aligned or be within 25 mm (1 in.) above the anti-ventilation plate of the outboard.

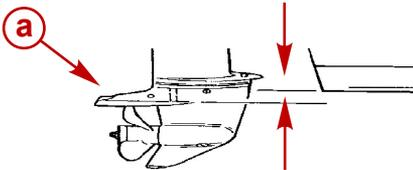

a - Anti-ventilation plate

27151

INSTALLING OUTBOARD ON TRANSOM

1. Place outboard on center line of transom.

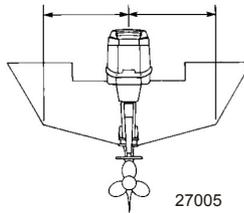

27005

2. Tighten transom clamp handles.

▲ WARNING

Failure to correctly fasten the outboard could result in the outboard propelling off the boat transom resulting in property damage, serious injury, or death. Before operation, the outboard must be correctly installed with the required mounting hardware.

INSTALLATION

3. Fasten outboard by drilling two 7.9 mm (5/16 in.) holes through the transom using transom clamp holes as a template. Fasten with two bolts, flat washers and locknuts. The use of clamp handles alone is insufficient to properly and safely secure the outboard to the transom. Use a marine waterproofing sealer in holes and around bolts to make the installation water tight.

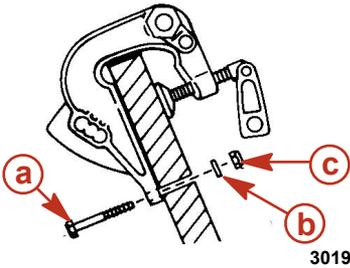

- a - Bolts (2)
- b - Flat washer (2)
- c - Locknut (2)

Battery Installation - Electric Start Models

MOUNTING BATTERY

Follow the battery manufacturer's instructions carefully. Mount battery in the boat so it is secured against movement, preferably in a battery box. Make sure battery is equipped with a nonconductive shield to prevent accidental shorting of battery terminals.

NOTE: *Electric starting outboards must have the battery cables connected to a battery whenever the engine is running, even if started manually, as damage to the charging system could result.*

Battery Connections

CONNECTING OUTBOARD BATTERY CABLES

1. First, connect the red battery cable to the (+) positive battery terminal and then connect the black battery cable to the (-) negative battery terminal.

DISCONNECTING OUTBOARD BATTERY CABLES

1. First, disconnect the black battery cable from the (-) negative terminal and then disconnect the red battery cable from the (+) positive terminal.

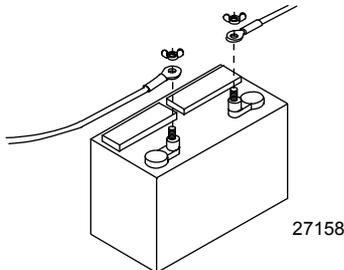

INSTALLATION

Propeller Selection

The propeller supplied with your outboard provides the best overall performance under average operating conditions.

Alternative propellers are available for specific boating requirements. See your outboard dealer.

