



MERCURY
GO BOLDLY.™

8M0133622 617 eng



**Operation
Maintenance
and
Installation
Manual**

75/90 TwoStroke

© 2017 Mercury Marine

Welcome

You have selected one of the finest marine power packages available. It incorporates numerous design features to ensure operating ease and durability.

With proper care and maintenance, you will enjoy using this product for many boating seasons. To ensure maximum performance and carefree use, we ask that you thoroughly read this manual.

The Operation and Maintenance Manual contains specific instructions for using and maintaining your product. We suggest that this manual remain with the product for ready reference whenever you are on the water.

Thank you for purchasing one of our products. We sincerely hope your boating will be pleasant!

Mercury Marine, Fond du Lac, Wisconsin, U.S.A.

Name / function:

John Pfeifer, President,
Mercury Marine



Read This Manual Thoroughly

IMPORTANT: If you do not understand any portion of this manual, contact your dealer. Your dealer can also provide a demonstration of actual starting and operating procedures.

Notice

Throughout this publication, and on your power package, warnings, cautions,

and notices, accompanied by the International Hazard Symbol , may be used to alert the installer and user to special instructions concerning a particular service or operation that may be hazardous if performed incorrectly or carelessly. Observe them carefully.

These safety alerts alone cannot eliminate the hazards that they signal. Strict compliance with these special instructions while performing the service, plus common sense operation, are major accident prevention measures.

WARNING

Indicates a hazardous situation which, if not avoided, could result in death or serious injury.

CAUTION

Indicates a hazardous situation which, if not avoided, could result in minor or moderate injury.

NOTICE

Indicates a situation which, if not avoided, could result in engine or major component failure.

IMPORTANT: Identifies information essential to the successful completion of the task.

NOTE: Indicates information that helps in the understanding of a particular step or action.

IMPORTANT: The operator (driver) is responsible for the correct and safe operation of the boat, the equipment aboard, and the safety of all occupants aboard. We strongly recommend that the operator read this Operation and Maintenance Manual and thoroughly understand the operational instructions for the power package and all related accessories before the boat is used.

⚠ WARNING

The engine exhaust from this product contains chemicals known to the state of California to cause cancer, birth defects or other reproductive harm.

The serial numbers are the manufacturer's keys to numerous engineering details that apply to your Mercury Marine power package. When contacting Mercury Marine about service, **always specify model and serial numbers.**

Descriptions and specifications contained herein were in effect at the time this was approved for printing. Mercury Marine, whose policies are based on continuous improvement, reserves the right to discontinue models at any time or to change specifications or designs without notice and without incurring obligation.

Warranty Message

The product you have purchased comes with a **limited warranty** from Mercury Marine; the terms of the warranty are set forth in the Warranty Manual included with the product. The Warranty Manual contains a description of what is covered, what is not covered, the duration of coverage, how to best obtain warranty coverage, **important disclaimers and limitations of damages**, and other related information. Please review this important information.

Copyright and Trademark Information

© **MERCURY MARINE. All rights reserved. Reproduction in whole or in part without permission is prohibited.**

Alpha, Axius, Bravo One, Bravo Two, Bravo Three, Circle M with Waves Logo, K-planes, Mariner, MerCathode, MerCruiser, Mercury, Mercury with Waves Logo, Mercury Marine, Mercury Precision Parts, Mercury Propellers, Mercury Racing, MotorGuide, OptiMax, Quicksilver, SeaCore, Skyhook, SmartCraft, Sport-Jet, Verado, VesselView, Zero Effort, Zeus, #1 On the Water and We're Driven to Win are registered trademarks of Brunswick Corporation. Pro XS is a trademark of Brunswick Corporation. Mercury Product Protection is a registered service mark of Brunswick Corporation.

Identification Records

Please record the following applicable information:

Outboard		
Engine Model and Horsepower		
Engine Serial Number		
Gear Ratio		
Propeller Number	Pitch	Diameter
Hull Identification Number (HIN)		Purchase Date
Boat Manufacturer	Boat Model	Length
Exhaust Gas Emissions Certification Number (Europe Only)		

General Information

Boater's Responsibilities.....	1
Before Operating Your Outboard.....	1
Boat Horsepower Capacity.....	1
High-Speed and High-Performance Boat Operation.....	2
Outboard Remote Control Models	2
Remote Steering Notice.....	3
Lanyard Stop Switch.....	3
Protecting People in the Water.....	6
Passenger Safety Message - Pontoon Boats and Deck Boats.....	6
Wave and Wake Jumping.....	8
Impact with Underwater Hazards.....	8
Exhaust Emissions.....	11
Selecting Accessories for Your Outboard.....	13
Safe Boating Recommendations.....	13
Recording Serial Number.....	15
75/90 Specifications.....	16
Component Identification.....	17

Transporting

Trailer Boat/Outboard	18
-----------------------------	----

Fuel and Oil

Fuel Requirements.....	19
Oil Recommendation.....	20
Fuel and Oil Ratio.....	20
Filling Oil Injection System.....	21
Filling Remote Oil Tank (If Equipped).....	22
Filling Fuel Tank.....	23

Features and Controls

Remote Control Features.....	24
Warning System.....	25
Engine Overspeed Limiter.....	26
Power Trim and Tilt (If equipped).....	27
Manual Tilt System.....	30
Throttle Grip Friction Adjustment - Tiller Handle Models.....	34
Steering Friction Adjustment - Tiller Handle Models.....	34
Trim Tab Adjustment.....	35

Operation

Important Daily Inspection Before Each Use	36
Prestarting Check List.....	36
Operating in Freezing Temperatures.....	37
Operating in Saltwater or Polluted Water.....	37
Effects of Elevation and Weather on Performance.....	37
Operating at High Elevations.....	38
Engine Break-in Procedure.....	38
Starting the Engine.....	38
Gear Shifting.....	42
Stopping the Engine	43
Emergency Starting	43
Setting Trim Angle While Running Engine at Idle Speed.....	46

Maintenance

Cleaning Care Recommendations.....	47
Inspection and Maintenance Schedule.....	49
Flushing the Cooling System.....	50
Flushing the Cooling System - Models with Accessory Hose Flush Attachment	51
Top Cowl Removal and Installation.....	52
Battery Inspection	53
Fuel System.....	53
Steering Link Rod Fasteners.....	55
Fuse Replacement.....	56
Corrosion Control Anode.....	56
Propeller Replacement.....	57
Spark Plug Inspection and Replacement.....	60
Lubrication Points.....	61
Checking Power Trim Fluid.....	63
Gearcase Lubrication.....	63
Submerged Outboard.....	65

Storage

Storage Preparation.....	66
Protecting External Outboard Components.....	66
Protecting Internal Engine Components.....	67
Gearcase.....	67
Draining Hose Flush Attachment (If Equipped).....	67
Positioning Outboard for Storage.....	67
Battery Storage.....	67

Troubleshooting

Starter Motor Will Not Crank the Engine.....	69
Engine Will Not Start.....	69
Engine Runs Erratically.....	69
Performance Loss.....	70
Battery Will Not Hold Charge.....	70

Owner Service Assistance

Service Assistance.....	71
Ordering Literature.....	73

Engine Installation

Mercury Marine Validated Engine Mounting Hardware.....	75
Accessories Mounted to the Transom Clamp Bracket.....	75
Fastening the Outboard to the Transom.....	79
Installing Outboard.....	84
Maximum Outboard Mounting Height.....	85

Maintenance Log

Maintenance Log.....	86
----------------------	----

GENERAL INFORMATION

Boater's Responsibilities

The operator (driver) is responsible for the correct and safe operation of the boat and the safety of its occupants and general public. It is strongly recommended that each operator read and understand this entire manual before operating the outboard.

Be sure that at least one additional person onboard is instructed in the basics of starting and operating the outboard and boat handling in case the driver is unable to operate the boat.

Before Operating Your Outboard

Read this manual carefully. Learn how to operate your outboard properly. If you have any questions, contact your dealer.

Safety and operating information that is practiced, along with using good common sense, can help prevent personal injury and product damage.

This manual as well as safety labels posted on the outboard use the following safety alerts to draw your attention to special safety instructions that should be followed.

WARNING

Indicates a hazardous situation which, if not avoided, could result in death or serious injury.

CAUTION

Indicates a hazardous situation which, if not avoided, could result in minor or moderate injury.

NOTICE

Indicates a situation which, if not avoided, could result in engine or major component failure.

Boat Horsepower Capacity

WARNING

Exceeding the boat's maximum horsepower rating can cause serious injury or death. Overpowering the boat can affect boat control and flotation characteristics or break the transom. Do not install an engine that exceeds the boat's maximum power rating.

GENERAL INFORMATION

Do not overpower or overload your boat. Most boats will carry a required capacity plate indicating the maximum acceptable power and load as determined by the manufacturer following certain federal guidelines. If in doubt, contact your dealer or the boat manufacturer.

U.S. COAST GUARD CAPACITY	
MAXIMUM HORSEPOWER	XXX
MAXIMUM PERSON CAPACITY (POUNDS)	XXX
MAXIMUM WEIGHT CAPACITY	XXX

26777

High-Speed and High-Performance Boat Operation

If your outboard is to be used on a high-speed or high-performance boat with which you are unfamiliar, we recommend that you do not operate it at its high speed capability without first requesting an initial orientation and familiarization demonstration ride with your dealer or an operator experienced with your boat/outboard combination. For additional information, obtain a copy of our **Hi-Performance Boat Operation** booklet from your dealer, distributor, or Mercury Marine.

Outboard Remote Control Models

The remote control connected to your outboard must be equipped with a start in neutral only protection device. This prevents the engine from starting when the shift is actuated in any position other than neutral.

▲ WARNING

Starting the engine with the drive in gear can cause serious injury or death. Never operate a boat that does not have a neutral-safety-protection device.



GENERAL INFORMATION

Remote Steering Notice

⚠ WARNING

Improper fasteners or improper installation procedures can result in loosening or disengagement of the steering link rod. This can cause a sudden, unexpected loss of boat control, resulting in serious injury or death due to occupants being thrown within or out of the boat. Always use required components and follow instructions and torque procedures.

The steering link rod that connects the steering cable to the engine must be fastened utilizing self-locking nuts. These self-locking nuts must never be replaced with common nuts (non-locking) as they will work loose and vibrate off, freeing the link rod to disengage.

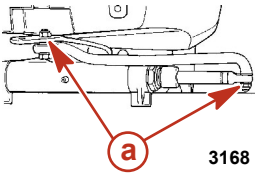

a - Self-locking nuts

Lanyard Stop Switch

The purpose of a lanyard stop switch is to turn off the engine when the operator moves far enough away from the operator's position (as in accidental ejection from the operator's position) to activate the switch. Tiller handle outboards and some remote control units are equipped with a lanyard stop switch. A lanyard stop switch can be installed as an accessory - generally on the dashboard or side adjacent to the operator's position.

A decal near the lanyard stop switch is a visual reminder for the operator to attach the lanyard to their personal flotation device (PFD) or wrist.

GENERAL INFORMATION

The lanyard cord is usually 122–152 cm (4–5 feet) in length when stretched out, with an element on one end made to be inserted into the switch and a clip on the other end for attaching to the operator's PFD or wrist. The lanyard is coiled to make its at-rest condition as short as possible to minimize the likelihood of lanyard entanglement with nearby objects. Its stretched-out length is made to minimize the likelihood of accidental activation should the operator choose to move around in an area close to the normal operator's position. If it is desired to have a shorter lanyard, wrap the lanyard around the operator's wrist or leg, or tie a knot in the lanyard.

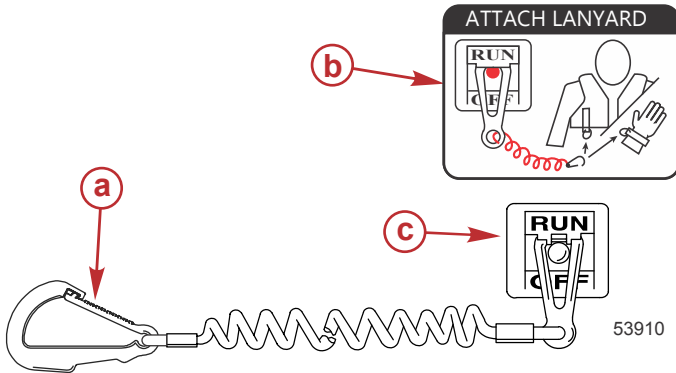

- a -** Lanyard cord clip
- b -** Lanyard decal
- c -** Lanyard stop switch

Read the following Safety Information before proceeding.

Important Safety Information: The purpose of a lanyard stop switch is to stop the engine when the operator moves far enough away from the operator's position to activate the switch. This would occur if the operator accidentally falls overboard or moves within the boat a sufficient distance from the operator's position. Falling overboard and accidental ejections are more likely to occur in certain types of boats such as low sided inflatables, bass boats, high performance boats, and light, sensitive handling fishing boats operated by a hand tiller. Falling overboard and accidental ejections are also likely to occur as a result of poor operating practices such as sitting on the back of the seat or gunwale at planing speeds, standing at planing speeds, sitting on elevated fishing boat decks, operating at planing speeds in shallow or obstacle infested waters, releasing your grip on a steering wheel or tiller handle that is pulling in one direction, drinking alcohol or consuming drugs, or daring high speed boat maneuvers.

GENERAL INFORMATION

While activation of the lanyard stop switch will stop the engine immediately, a boat will continue to coast for some distance depending upon the velocity and degree of any turn at shut down. However, the boat will not complete a full circle. While the boat is coasting, it can cause injury to anyone in the boat's path as seriously as the boat would when under power.

We strongly recommend that other occupants be instructed on proper starting and operating procedures should they be required to operate the engine in an emergency (if the operator is accidentally ejected).

⚠ WARNING

If the operator falls out of the boat, stop the engine immediately to reduce the possibility of serious injury or death from being struck by the boat. Always properly connect the operator to the stop switch using a lanyard.

⚠ WARNING

Avoid serious injury or death from deceleration forces resulting from accidental or unintended stop switch activation. The boat operator should never leave the operator's station without first disconnecting the stop switch lanyard from the operator.

Accidental or unintended activation of the switch during normal operation is also a possibility. This could cause any, or all, of the following potentially hazardous situations:

- Occupants could be thrown forward due to unexpected loss of forward motion - a particular concern for passengers in the front of the boat who could be ejected over the bow and possibly struck by the gearcase or propeller.
- Loss of power and directional control in heavy seas, strong current, or high winds.
- Loss of control when docking.

KEEP THE LANYARD STOP SWITCH AND LANYARD CORD IN GOOD OPERATING CONDITION

Before each use, check to ensure the lanyard stop switch works properly. Start the engine and stop it by pulling the lanyard cord. If the engine does not stop, have the switch repaired before operating the boat.

Before each use, visually inspect the lanyard cord to ensure it is in good working condition and that there are no breaks, cuts, or wear to the cord. Check that the clips on the ends of the cord are in good condition. Replace any damaged or worn lanyard cords.

GENERAL INFORMATION

Protecting People in the Water

WHILE YOU ARE CRUISING

It is very difficult for a person standing or floating in the water to take quick action to avoid a boat heading in his/her direction, even at slow speed.



Always slow down and exercise extreme caution any time you are boating in an area where there might be people in the water.

Whenever a boat is moving (coasting) and the outboard gear shift is in neutral position, there is sufficient force by the water on the propeller to cause the propeller to rotate. This neutral propeller rotation can cause serious injury.

WHILE THE BOAT IS STATIONARY

▲ WARNING

A spinning propeller, a moving boat, or any solid device attached to the boat can cause serious injury or death to swimmers. Stop the engine immediately whenever anyone in the water is near your boat.

Shift the outboard into neutral and shut off the engine before allowing people to swim or be in the water near your boat.

Passenger Safety Message - Pontoon Boats and Deck Boats

Whenever the boat is in motion, observe the location of all passengers. Do not allow any passengers to stand or use seats other than those designated for traveling faster than idle speed. A sudden reduction in boat speed, such as plunging into a large wave or wake, a sudden throttle reduction, or a sharp change of boat direction, could throw them over the front of the boat. Falling over the front of the boat between the two pontoons will position them to be run over by the outboard.

BOATS HAVING AN OPEN FRONT DECK

No one should ever be on the deck in front of the fence while the boat is in motion. Keep all passengers behind the front fence or enclosure.

GENERAL INFORMATION

Persons on the front deck could easily be thrown overboard or persons dangling their feet over the front edge could get their legs caught by a wave and pulled into the water.

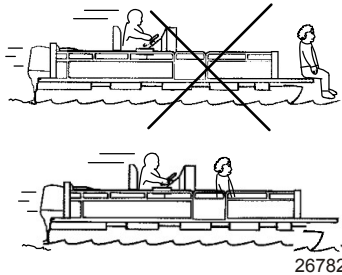

⚠ WARNING

Sitting or standing in an area of the boat not designed for passengers at speeds above idle can cause serious injury or death. Stay back from the front end of deck boats or raised platforms and remain seated while the boat is in motion.

BOATS WITH FRONT MOUNTED, RAISED PEDESTAL FISHING SEATS

Elevated fishing seats are not intended for use when the boat is traveling faster than idle or trolling speed. Sit only in seats designated for traveling at faster speeds.

Any unexpected, sudden reduction in boat speed could result in the elevated passenger falling over the front of the boat.

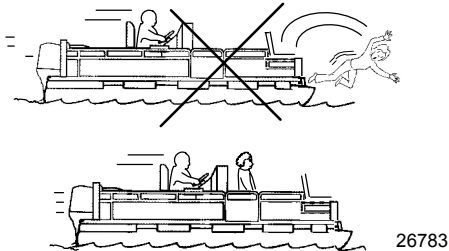

GENERAL INFORMATION

Wave and Wake Jumping

Operating recreational boats over waves and wake is a natural part of boating. However, when this activity is done with sufficient speed to force the boat hull partially or completely out of the water, certain hazards arise, particularly when the boat enters the water.

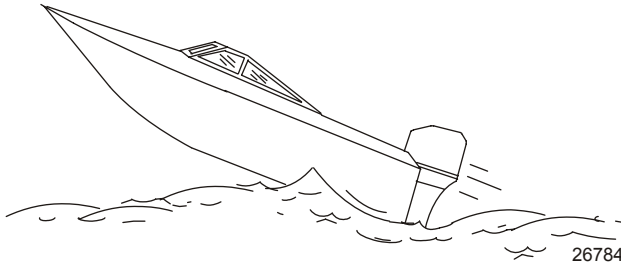

The primary concern is the boat changing direction while in the midst of the jump. In such case, the landing may cause the boat to veer violently in a new direction. Such a sharp change in direction can cause occupants to be thrown out of their seats, or out of the boat.

⚠ WARNING

Wave or wake jumping can cause serious injury or death from occupants being thrown within or out of the boat. Avoid wave or wake jumping whenever possible.

There is another less common hazardous result from allowing your boat to launch off a wave or wake. If the bow of your boat pitches down far enough while airborne, upon water contact it may penetrate under the water surface and submarine for an instant. This will bring the boat to a nearly instantaneous stop and can send the occupants flying forward. The boat may also steer sharply to one side.

Impact with Underwater Hazards

Your outboard may be equipped with a hydraulic trim and tilt system that also contains a shock absorbing feature. This feature helps the outboard withstand damage in the case of impact with an underwater object at low to moderate speeds. At higher speeds, the force of the impact may exceed the system's ability to absorb the energy of the impact and cause serious product damage.

No impact protection exists while in reverse. Use extreme caution when operating in reverse to avoid striking underwater objects.

GENERAL INFORMATION

Reduce speed and proceed with caution whenever you drive a boat in shallow water areas or in areas where you suspect underwater obstacles may exist that could be struck by the outboard or the boat bottom. **The most significant action you can take to help reduce injury or impact damage from striking a floating or underwater object is to control the boat speed. Under these conditions, boat speed should be kept to the minimum planing speed, typically 24 to 40 km/h (15 to 25 mph).**

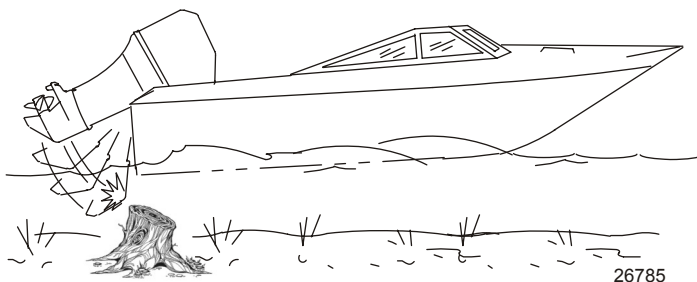

▲ WARNING

Avoid serious injury or death from all or part of an outboard or drive unit coming into the boat after striking a floating or underwater object. When operating in waters where objects may be at the surface or just under the surface of the water, reduce your speed and keep a vigilant lookout.

Examples of objects that can cause engine damage are dredging pipes, bridge supports, wing dams, trees, stumps, and rocks.

Striking a floating or underwater object could result in any of an infinite number of situations. Some of these situations could yield the following:

- Part of the outboard or the entire outboard could break loose and fly into the boat.
- The boat could move suddenly in a new direction. A sharp change in direction can cause occupants to be thrown out of their seats or out of the boat.
- The boat's speed could rapidly reduce. This will cause occupants to be thrown forward or even out of the boat.
- The outboard or boat could sustain impact damage.

After striking a submerged object, stop the engine as soon as possible and inspect it for any broken or loose parts. If damage is present or suspected, the outboard should be taken to an authorized dealer for a thorough inspection and necessary repair.

The boat should also be checked for any hull fractures, transom fractures, or water leaks. If water leaks are discovered after an impact, immediately activate the bilge pump.

GENERAL INFORMATION

Operating a damaged outboard could cause additional damage to other parts of the outboard or could affect control of the boat. If continued running is necessary, do so at greatly reduced speeds.

▲ WARNING

Operating a boat or engine with impact damage can result in product damage, serious injury, or death. If the vessel experiences any form of impact, have an authorized Mercury Marine dealer inspect and repair the vessel or power package.

SAFETY INSTRUCTIONS FOR HAND-TILLED OUTBOARDS

No person or cargo should occupy the area directly in front of the outboard while the boat is in motion. If an underwater obstacle is struck, the outboard will tilt up and could seriously injure anyone occupying this area.

Models with Clamp Screws:

Some outboards come with transom bracket clamp screws. The use of clamp bracket screws alone is insufficient to properly and safely secure the outboard to the transom. Proper installation of the outboard includes bolting the engine to the boat through the transom. Refer to **Engine Installation - Installing Outboard** for more complete installation information.

▲ WARNING

Failure to correctly fasten the outboard could result in the outboard propelling off the boat transom resulting in property damage, serious injury, or death. Before operation, the outboard must be correctly installed with the required mounting hardware.

This product must be secured to the transom with the required mounting hardware. If the outboard strikes an under water object, the required mounting hardware prevents the outboard from propelling off the transom. A decal on the swivel bracket reminds the installer of the potential hazard.



52375

GENERAL INFORMATION

Exhaust Emissions

BE ALERT TO CARBON MONOXIDE POISONING

Carbon monoxide (CO) is a deadly gas that is present in the exhaust fumes of all internal combustion engines, including the engines that propel boats, and the generators that power boat accessories. By itself, CO is odorless, colorless, and tasteless, but if you can smell or taste engine exhaust, you are inhaling CO.

Early symptoms of carbon monoxide poisoning, which are similar to the symptoms of seasickness and intoxication, include headache, dizziness, drowsiness, and nausea.

▲ WARNING

Inhaling engine exhaust gases can result in carbon monoxide poisoning, which can lead to unconsciousness, brain damage, or death. Avoid exposure to carbon monoxide.

Stay clear from exhaust areas when engine is running. Keep the boat well-ventilated while at rest or underway.

STAY CLEAR OF EXHAUST AREAS

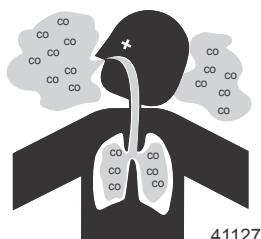

Engine exhaust gases contain harmful carbon monoxide. Avoid areas of concentrated engine exhaust gases. When engines are running, keep swimmers away from the boat, and do not sit, lie, or stand on swim platforms or boarding ladders. While underway, do not allow passengers to be positioned immediately behind the boat (platform dragging, teak/body surfing). This dangerous practice not only places a person in an area of high engine exhaust concentration, but also subjects them to the possibility of injury from the boat propeller.

GOOD VENTILATION

Ventilate the passenger area, open side curtains or forward hatches to remove fumes.

GENERAL INFORMATION

Example of desired air flow through the boat:

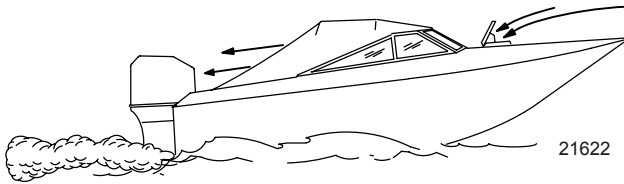

POOR VENTILATION

Under certain running and/or wind conditions, permanently enclosed or canvas enclosed cabins or cockpits with insufficient ventilation may draw in carbon monoxide. Install one or more carbon monoxide detectors in your boat.

Although the occurrence is rare, on a very calm day, swimmers and passengers in an open area of a stationary boat that contains, or is near, a running engine may be exposed to a hazardous level of carbon monoxide.

1. Examples of poor ventilation while the boat is stationary:

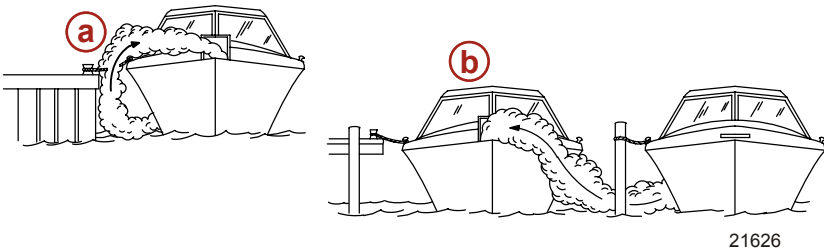

- a** - Operating the engine when the boat is moored in a confined space
- b** - Mooring close to another boat that has its engine operating

2. Examples of poor ventilation while the boat is moving:



- a** - Operating the boat with the trim angle of the bow too high
- b** - Operating the boat with no forward hatches open (station wagon effect)

GENERAL INFORMATION

Selecting Accessories for Your Outboard

Genuine Mercury Precision or Quicksilver Accessories have been specifically designed and tested for your outboard. These accessories are available from Mercury Marine dealers.

IMPORTANT: Check with your dealer before installing accessories. The misuse of approved accessories or the use of nonapproved accessories can damage the product.

Some accessories not manufactured or sold by Mercury Marine are not designed to be safely used with your outboard or outboard operating system. Acquire and read the installation, operation and maintenance manuals for all your selected accessories.

Safe Boating Recommendations

To safely enjoy the waterways, familiarize yourself with local and all other governmental boating regulations and restrictions and consider the following suggestions.

Know and obey all nautical rules and laws of the waterways.

- We recommend that all powerboat operators complete a boating safety course. In the U.S., the U.S. Coast Guard Auxiliary, the Power Squadron, the Red Cross, and your state or provincial boating law enforcement agency provide courses. For more information in the U.S., call the Boat U.S. Foundation at 1-800-336-BOAT (2628).

Perform safety checks and required maintenance.

- Follow a regular schedule and ensure that all repairs are properly made.

Check safety equipment onboard.

- Here are some suggestions of the types of safety equipment to carry when boating:
 - Approved fire extinguishers
 - Signal devices: flashlight, rockets or flares, flag, and whistle or horn
 - Tools necessary for minor repairs
 - Anchor and extra anchor line
 - Manual bilge pump and extra drain plugs
 - Drinking water
 - Radio
 - Paddle or oar
 - Spare propeller, thrust hubs, and an appropriate wrench
 - First aid kit and instructions
 - Waterproof storage containers

GENERAL INFORMATION

- Spare operating equipment, batteries, bulbs, and fuses
- Compass and map or chart of the area
- Personal flotation device (one per person onboard)

Watch for signs of weather change and avoid foul weather and rough-sea boating.

Tell someone where you are going and when you expect to return.

Passenger boarding.

- Stop the engine whenever passengers are boarding, unloading, or are near the back (stern) of the boat. Shifting the drive unit into neutral is not sufficient.

Use personal flotation devices.

- Federal law requires that there be a U.S. Coast Guard-approved life jacket (personal flotation device), correctly sized and readily accessible for every person onboard, plus a throwable cushion or ring. We strongly advise that everyone wear a life jacket at all times while in the boat.

Prepare other boat operators.

- Instruct at least one person onboard in the basics of starting and operating the engine and boat handling in case the driver becomes disabled or falls overboard.

Do not overload your boat.

- Most boats are rated and certified for maximum load (weight) capacities (refer to your boat's capacity plate). Know your boat's operating and loading limitations. Know if your boat will float if it is full of water. When in doubt, contact your authorized Mercury Marine dealer or the boat manufacturer.

Ensure that everyone in the boat is properly seated.

- Do not allow anyone to sit or ride on any part of the boat that was not intended for such use. This includes the backs of seats, gunwales, transom, bow, decks, raised fishing seats, and any rotating fishing seat. Passengers should not sit or ride anywhere that sudden unexpected acceleration, sudden stopping, unexpected loss of boat control, or sudden boat movement could cause a person to be thrown overboard or into the boat. Ensure that all passengers have a proper seat and are in it before any boat movement.

Never operate a boat while under the influence of alcohol or drugs. It is the law.

- Alcohol or drugs can impair your judgment and greatly reduce your ability to react quickly.

Know your boating area and avoid hazardous locations.

Be alert.

GENERAL INFORMATION

- The operator of the boat is responsible by law to maintain a proper lookout by sight and hearing. The operator must have an unobstructed view particularly to the front. No passengers, load, or fishing seats should block the operator's view when the boat is above idle or planing transition speed. Watch out for others, the water, and your wake.

Never drive your boat directly behind a water skier.

- Your boat traveling at 40 km/h (25 mph) will overtake a fallen skier who is 61 m (200 ft) in front of you in five seconds.

Watch fallen skiers.

- When using your boat for waterskiing or similar activities, always keep a fallen or down skier on the operator's side of the boat while returning to attend to the skier. The operator should always have the down skier in sight and never back up to the skier or anyone in the water.

Report accidents.

- Boat operators are required by law to file a boating accident report with their state boating law enforcement agency when their boat is involved in certain boating accidents. A boating accident must be reported if 1) there is loss of life or probable loss of life, 2) there is personal injury requiring medical treatment beyond first aid, 3) there is damage to boats or other property where the damage value exceeds \$500.00, or 4) there is complete loss of the boat. Seek further assistance from local law enforcement.

Recording Serial Number

It is important to record this number for future reference. The serial number is located on the outboard as shown.

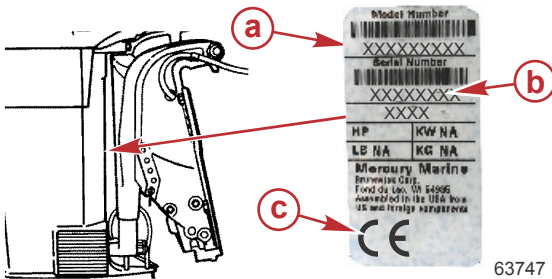

- a** - Model year
- b** - Serial number
- c** - Certified Europe Insignia (as applicable)

GENERAL INFORMATION

75/90 Specifications

Models	75	90
Horsepower	75	90
Kilowatts	55	66
Full throttle RPM range	4750–5250	5000–5500
Idle speed in forward gear	650–700 RPM	
Number of cylinders	3	
Piston displacement	1385.8 cc (84.57 in ³)	
Cylinder bore	88.9 mm (3.500 in.)	
Stroke	74 mm (2.930 in.)	
Recommended spark plug	NGK BUZHW-2	
Spark plug gap	Surface Gap	
Gear ratio	2.3:1	
Recommended gasoline	Refer to Fuel and Oil	
Recommended oil	Refer to Fuel and Oil	
Gearcase lubricant capacity	666 ml (22.5 fl oz)	
Battery rating	500 marine cranking amps (MCA) or 450 cold cranking amps (CCA)	
Amp hour (Ah)	70–100	

GENERAL INFORMATION

Component Identification

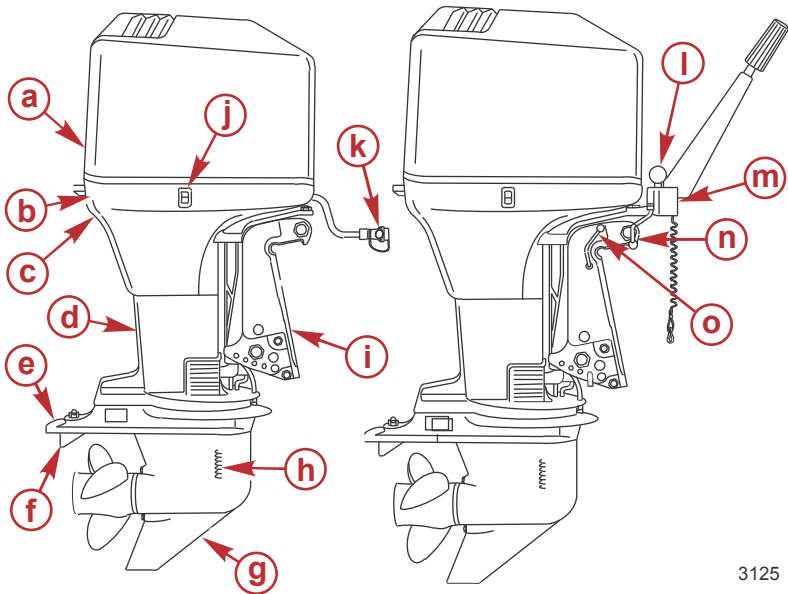

3125

- a** - Top cowl
- b** - Bottom cowl
- c** - Water pump indicator hole
- d** - Driveshaft housing
- e** - Anti-ventilation plate
- f** - Trim tab
- g** - Gearcase
- h** - Cooling water intake
- i** - Transom bracket
- j** - Auxiliary tilt switch
- k** - Hose flush attachment (if equipped)
- l** - Shift handle
- m** - Lanyard stop switch
- n** - Steering friction adjustment knob
- o** - Tilt lock lever

TRANSPORTING

Trailing Boat/Outboard

Trail your boat with the outboard tilted down in a vertical operating position.

If additional ground clearance is required, the outboard should be tilted up using an accessory outboard support device. Refer to your local dealer for recommendations. Additional clearance may be required for railroad crossings, driveways, and trailer bouncing.

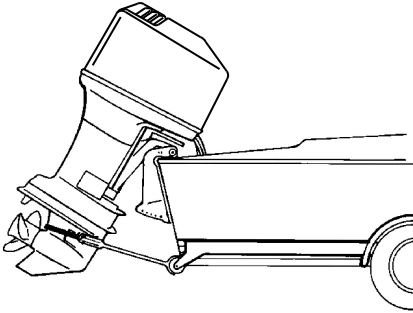

28419

IMPORTANT: Do not rely on the power trim/tilt system or tilt support lever to maintain proper ground clearance for trailering. The outboard tilt support lever is not intended to support the outboard for trailering.

Shift the outboard to forward gear. This prevents the propeller from spinning freely.

FUEL AND OIL

Fuel Requirements

IMPORTANT: Use of improper gasoline can damage your engine. Engine damage resulting from the use of improper gasoline is considered misuse of the engine and will not be covered under the limited warranty.

FUEL RATINGS

Mercury outboard engines will operate satisfactorily with any major brand of unleaded gasoline that meets the following specifications:

USA and Canada - A posted pump octane rating of 87 (R+M)/2, minimum, for most models. Premium gasoline 91 (R+M)/2 octane is also acceptable for most models. **Do not** use leaded gasoline.

Outside USA and Canada - A posted pump octane rating of 91 RON, minimum, for most models. Premium gasoline (95 RON) is also acceptable for all models. **Do not** use leaded gasoline.

USING REFORMULATED (OXYGENATED) GASOLINE (USA ONLY)

Reformulated gasoline is required in certain areas of the USA and is acceptable for use in your Mercury Marine engine. The only oxygenate currently in use in the USA is alcohol (ethanol, methanol, or butanol).

GASOLINE CONTAINING ALCOHOL

Bu16 Butanol Fuel Blends

Fuel blends of up to 16.1% butanol (Bu16) that meet the published Mercury Marine fuel rating requirements are an acceptable substitute for unleaded gasoline. Contact your boat manufacturer for specific recommendations on your boat's fuel system components (fuel tanks, fuel lines, and fittings).

Methanol and Ethanol Fuel Blends

IMPORTANT: The fuel system components on your Mercury Marine engine will withstand up to 10% alcohol (methanol or ethanol) content in the gasoline. Your boat's fuel system may not be capable of withstanding the same percentage of alcohol. Contact your boat manufacturer for specific recommendations on your boat's fuel system components (fuel tanks, fuel lines, and fittings).

Be aware that gasoline containing methanol or ethanol may cause increased:

- Corrosion of metal parts
- Deterioration of rubber or plastic parts
- Fuel permeation through the rubber fuel lines
- Likelihood of phase separation (water and alcohol separating from the gasoline in the fuel tank)

FUEL AND OIL

⚠ WARNING

Fuel leakage is a fire or explosion hazard, which can cause serious injury or death. Periodically inspect all fuel system components for leaks, softening, hardening, swelling, or corrosion, particularly after storage. Any sign of leakage or deterioration requires replacement before further engine operation.

IMPORTANT: If you use gasoline that contains or might contain methanol or ethanol, you must increase the frequency of inspection for leaks and abnormalities.

IMPORTANT: When operating a Mercury Marine engine on gasoline containing methanol or ethanol, do not store the gasoline in the fuel tank for long periods. Cars normally consume these blended fuels before they can absorb enough moisture to cause trouble; boats often sit idle long enough for phase separation to take place. Internal corrosion may occur during storage if alcohol has washed protective oil films from internal components.

Oil Recommendation

Recommended Oil	Mercury or Quicksilver Premium 2-Cycle TC-W3 Outboard Oil
-----------------	---

IMPORTANT: Oil must be NMMA certified TC-W3 2-Cycle oil.

Mercury or Quicksilver Premium TC-W3 2-Cycle oil is recommended for this engine. For added protection and lubrication, Mercury or Quicksilver Premium Plus TC-W3 2-Cycle oil is recommended. If Mercury or Quicksilver outboard oil is not available, substitute another brand of 2-cycle outboard oil that is NMMA Certified TC-W3. Severe engine damage may result from use of an inferior oil.

Fuel and Oil Ratio

MODELS WITH OIL INJECTION

Use a 50:1 (2%) gasoline/oil mixture in the first tank of fuel. Follow the table below for mixing ratios. Use of this fuel mixture combined with oil from the oil injection system will supply adequate lubrication during engine break-in.

After the break-in fuel mixture is used up, it is no longer necessary to add oil with the gasoline.

NOTE: At the end of the break-in period, visually check to see if the oil level in the oil injection system has dropped. Oil usage indicates the oil injection system is functioning correctly.

GASOLINE/OIL MIXING RATIO CHART			
Gas/Oil Ratio	3.8 liters (1 gal) gas	11.5 liters (3 gal) gas	23 liters (6 gal) gas
50:1 (2%)	89 ml (3 fl oz) oil	237 ml (8 fl oz) oil	473 ml (16 fl oz) oil

FUEL AND OIL

MODELS WITHOUT OIL INJECTION

Use a 25:1 (4%) gasoline/oil mixture in the first tank of fuel.

After the break-in fuel mixture is used up, use a 50:1 (2%) gasoline/oil mixture. Follow the table for mixing ratios.

GASOLINE/OIL MIXING RATIO CHART			
Gas/Oil Ratio	3.8 liters (1 gal) gas	11.5 liters (3 gal) gas	23 liters (6 gal) gas
25:1 (4%)	148 ml (5 fl oz) oil	473 ml (16 fl oz) oil	946 ml (32 fl oz) oil
50:1 (2%)	89 ml (3 fl oz) oil	237 ml (8 fl oz) oil	473 ml (16 fl oz) oil

Filling Oil Injection System

1. Place the outboard in a vertical operating position. Remove cowl cap.

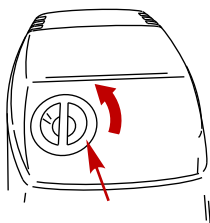

29462

2. Remove oil filler cap and pull out dipstick.

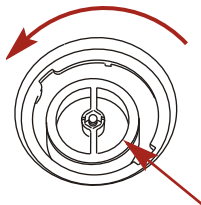

2890

3. Use the dipstick to check oil level.

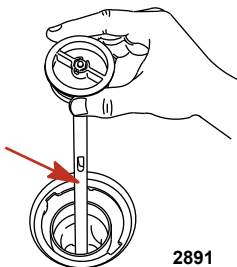

2891

FUEL AND OIL

- Hook the dipstick on the tank during filling.

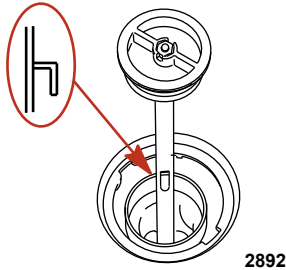

- Slowly fill the oil tank with the specified oil. Do not overfill. Add only enough oil to bring the oil level up to the bottom of the fill neck.

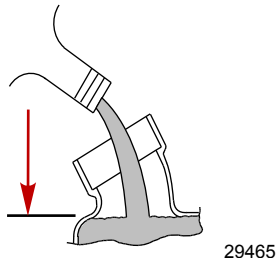

Model	Capacity	Fluid Type
3 cylinder	3 liters (3.2 qt.)	Mercury or Quicksilver Premium TC-W3 2-Cycle

- Install oil filler cap and retighten. Reinstall the cowl cap.

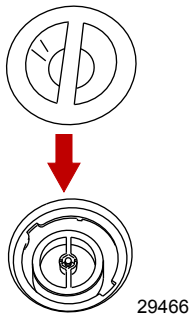

Filling Remote Oil Tank (If Equipped)

- Remove fill cap and fill with the specified oil.

FUEL AND OIL

	Capacity	Fluid Type
Oil tank	11.5 liters (3 gal)	Mercury or Quicksilver Premium 2-cycle TC-W3 outboard oil

2. Reinstall filler cap and tighten securely.
3. Check oil level in the engine oil injection tank. The oil level should be 1/2 full to completely full. Refill if necessary.

IMPORTANT: Always make sure the oil tank caps are threaded on tight. An air leak will prevent oil flow to the engine.

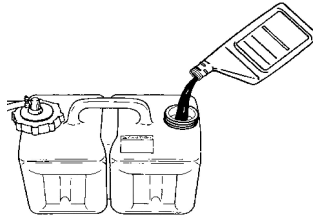

2723

Filling Fuel Tank

⚠ WARNING

Avoid serious injury or death from a gasoline fire or explosion. Use caution when filling fuel tanks. Always stop the engine and do not smoke or allow open flames or sparks in the area while filling fuel tanks.

Fill the fuel tanks outdoors away from heat, sparks, and open flames.

Remove the portable fuel tanks from the boat to fill them.

Always stop the engine before filling the tanks.

Do not completely fill the fuel tanks. Leave approximately 10% of the tank volume unfilled. Fuel will expand in volume as its temperature rises and can leak under pressure if the tank is completely filled.

PORTABLE FUEL TANK PLACEMENT IN THE BOAT

Place the fuel tank in the boat so the vent is higher than the fuel level under normal boat operating conditions.

FEATURES AND CONTROLS

Remote Control Features

Your boat may be equipped with one of the Mercury Precision or Quicksilver remote controls shown. If not, consult your dealer for a description of the functions and operations of the remote control.

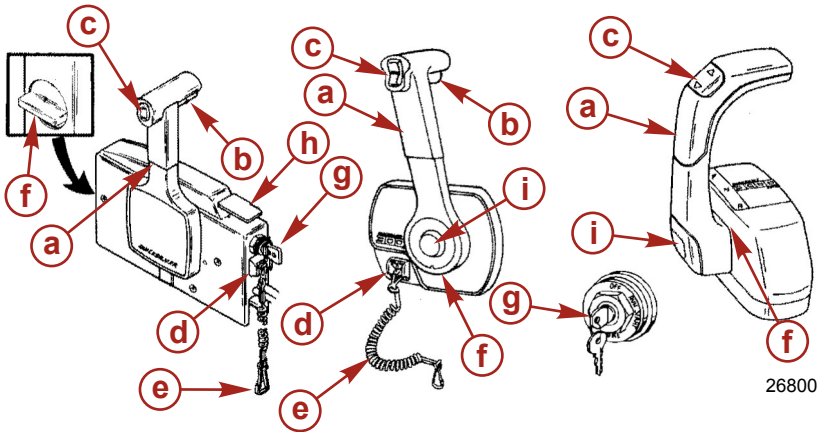

- a** - Control handle – forward, neutral, reverse
- b** - Neutral release lever
- c** - Trim/tilt switch (if equipped) – Refer to **Features and Controls – Power Trim and Tilt**
- d** - Lanyard stop switch – Refer to **General Information – Lanyard Stop Switch**
- e** - Lanyard – Refer to **General Information – Lanyard Stop Switch**
- f** - Throttle friction adjustment – Console controls require cover removal for adjustment
- g** - Ignition key switch – "OFF," "ON," "START"
- h** - Fast idle lever – Refer to **Operation – Starting the Engine**
- i** - Throttle only button – Refer to **Operation – Starting the Engine**

FEATURES AND CONTROLS

Warning System

The outboard warning system incorporates a warning horn inside the boat. Remote control models will have the warning horn located inside the remote control or connected to the ignition key switch.

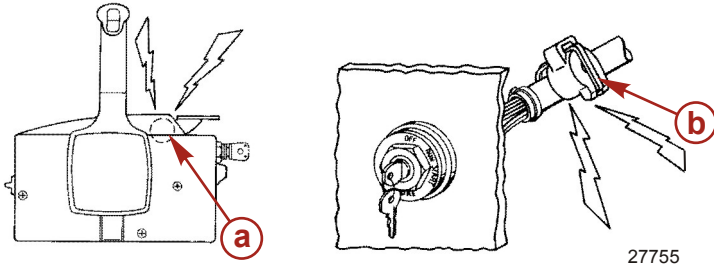

- a** - Warning horn inside remote control
- b** - Warning horn inside key switch

Tiller handle models will have the warning horn located below the tiller handle.

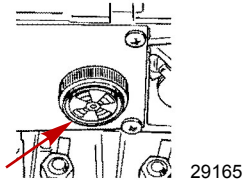

WARNING SYSTEM OPERATION

The warning horn will emit a continuous beep. This will alert the operator and help identify the following listed situations.

Warning System		
Function	Sound	Description
Engine Over Temperature	Continuous	Engine Over Heat
Low Oil Level (Oil Injected Models)	Continuous	Low Oil Level

FEATURES AND CONTROLS

ENGINE OVERHEAT

If the engine overheats, immediately reduce throttle speed to idle. Shift outboard into neutral and check for a steady stream of water coming out of the water pump indicator hole.

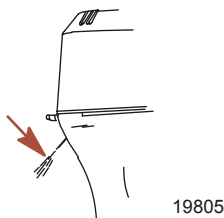

If no water is coming out of the water pump indicator hole or flow is intermittent, stop engine and check the cooling water intake holes for obstruction. If no obstruction is found, there may be a blockage in the cooling system or a water pump problem. Have the outboard checked by your dealer. Operating the engine while overheated will cause engine damage.

NOTE: *Should overheating occur and you are stranded, stop the engine and allow it to cool down. This will usually allow some additional low speed (idle) running time before the engine starts to overheat again. Operating an overheated engine will cause engine damage.*

If a steady flow of water is coming out of the water pump indicator hole and the engine continues to overheat, consult your dealer. Operating an overheated engine will cause engine damage.

LOW OIL LEVEL

The warning system will be activated if the oil level drops below the low oil level on the dipstick. There is still oil reserve remaining for 30 minutes of full speed operation. Refer to **Fuel and Oil - Filling Oil Injection System**.

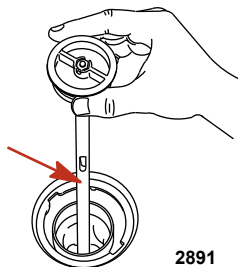

Engine Overspeed Limiter

The outboard is equipped with an engine overspeed limiter which limits the engine maximum RPM. This will protect the engine from mechanical damage.

Some causes of engine overspeed are as follows:

FEATURES AND CONTROLS

- Propeller ventilation.
- A propeller which has an incorrect pitch or diameter.
- Propeller hub slippage.
- Outboard mounted too high on the transom.
- Tilting the outboard out beyond a vertical position.
- Cavitation of the propeller due to rough water or obstruction in the boat hull.

When the engine overspeed limiter is activated, the engine timing will be momentarily retarded to decrease the engine speed. Excessive overspeed (above 5700 RPM) will result in cutout of the cylinders ignition to prevent operation above this limit.

Power Trim and Tilt (If equipped)

Your outboard has a trim/tilt control called Power Trim. This enables the operator to easily adjust the position of the outboard by pressing the trim switch. Moving the outboard in closer to the boat transom is called trimming in or down. Moving the outboard further away from the boat transom is called trimming out or up. The term trim generally refers to the adjustment of the outboard within the first 20° range of travel. This is the range used while operating your boat on plane. The term tilt is generally used when referring to adjusting the outboard further up out of the water. With the engine turned off, the outboard can be tilted out of the water. At low idle speed, the outboard can also be tilted up past the trim range to permit, for example, shallow water operation.

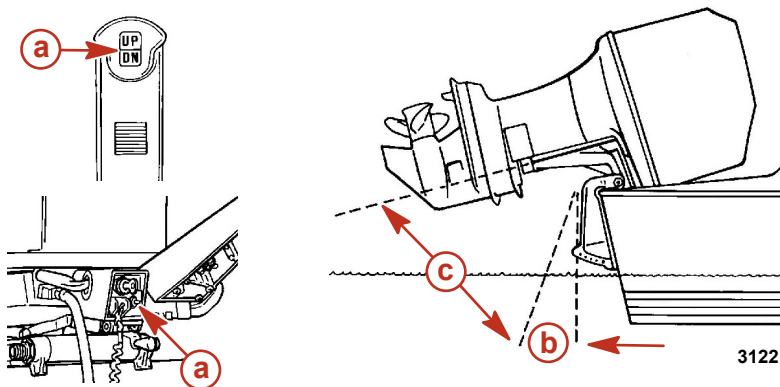

3122

- a** - Trim switch
- b** - Trim range of travel
- c** - Tilt range of travel

FEATURES AND CONTROLS

POWER TRIM OPERATION

With most boats, operating around the middle of the trim range will give satisfactory results. However, to take full advantage of the trimming capability there may be times when you choose to trim your outboard all the way in or out. Along with an improvement in some performance aspects comes a greater responsibility for the operator, and this is being aware of some potential control hazards.

The most significant control hazard is a pull or torque that can be felt on the steering wheel or tiller handle. This steering torque results from the outboard being trimmed so the propeller shaft is not parallel to the water surface.

WARNING

Trimming the outboard beyond a neutral steering condition may result in a pull on the steering wheel or tiller handle and loss of boat control. Maintain control of the boat if trimming beyond a neutral steering condition.

Consider the following lists carefully.

1. Trimming in or down can:
 - Lower the bow.
 - Result in quicker planing off, especially with a heavy load or a stern heavy boat.
 - Generally improve the ride in choppy water.
 - Increase steering torque or pull to the right (with the normal right-hand rotation propeller.)
 - In excess, can lower the bow of some boats to a point where they begin to plow with their bow in the water while on plane. This can result in an unexpected turn in either direction (called bow steering or oversteering) if any turn is attempted, or if a significant wave is encountered.

WARNING

Operating the boat at high speeds with the outboard trimmed too far under can create excessive bow steer, resulting in the operator losing control of the boat. Install the trim limit pin in a position that prevents excessive trim under and operate the boat in a safe manner.

- In rare circumstances, the owner may decide to limit the trim in. This can be accomplished by purchasing a stainless steel tilt pin from your dealer and inserting it in whatever adjustment hole in the transom brackets is desired. The nonstainless steel shipping bolt should not be used in this application other than on a temporary basis.
2. Trimming out or up can:
 - Lift the bow higher out of the water.
 - Generally increase top speed.

FEATURES AND CONTROLS

- Increase clearance over submerged objects or a shallow bottom.
- Increase steering torque or pull to the left at a normal installation height (with the normal right-hand rotation propeller.)
- In excess, can cause boat porpoising (bouncing) or propeller ventilation.
- Cause engine overheating if any cooling water intake holes are above the waterline.

TILTING OPERATION

To tilt outboard, shut off the engine and press the trim/tilt switch or auxiliary tilt switch to the up position. The outboard will tilt up until the switch is released or it reaches its maximum tilt position.

1. Engage the tilt support lever, by rotating knob to bring the support lever upward.
2. Lower outboard to rest on the tilt support lever.
3. Disengage the tilt support lever, by raising the outboard off the support lever and rotating the lever down. Lower the outboard.

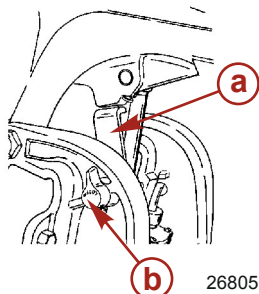

- a - Tilt support lever
- b - Knob

MANUAL TILTING

If the outboard cannot be tilted using the power trim/tilt switch, the outboard can be manually tilted.

1. Turn out the manual tilt release valve 3 turns (counterclockwise). This allows manual tilting of the outboard.

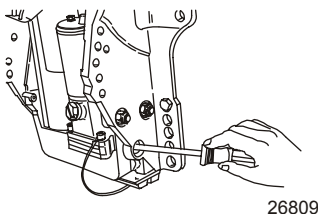

NOTE: The manual tilt release valve must be tightened before operating the outboard to prevent the outboard from tilting up during reverse operation.

FEATURES AND CONTROLS

2. Tilt the outboard to the desired position and tighten the manual tilt release valve.

AUXILIARY TILT SWITCH

The auxiliary tilt switch can be used to tilt the outboard up or down using the power trim system.

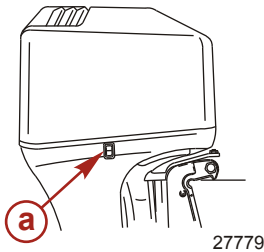

a - Auxiliary tilt switch

SHALLOW WATER OPERATION

When operating your boat in shallow water, you can tilt the outboard beyond the maximum trim range to prevent hitting bottom.

1. Reduce the engine speed below 2000 RPM.
2. Tilt the outboard up. Make sure all the water intake holes stay submerged at all times.
3. Operate the engine at slow speed only. If engine speed exceeds 2000 RPM, the outboard will automatically return down to the maximum trim range.

Manual Tilt System

Models without power trim are equipped with a tilt assist system that allows the operator to easily tilt and lock the outboard at any tilt position from full down to full up.

This tilt system is designed to be adjusted when the outboard is idling in neutral or with the engine turned off.

▲ WARNING

Operating the engine without engaging the tilt lock lever can cause serious injury or death. The outboard can tilt upwards when decelerating or operating in reverse, causing loss of boat control. Always lock the outboard in its run position before operating.

Before operating, the outboard must be locked in its tilt position by moving the tilt lock lever to the lock/run position.

FEATURES AND CONTROLS

BASIC TILTING OPERATION

Move tilt lock lever to the tilt position. Tilt outboard to desired position and lock in place by moving the tilt lock lever back to the lock/run position.

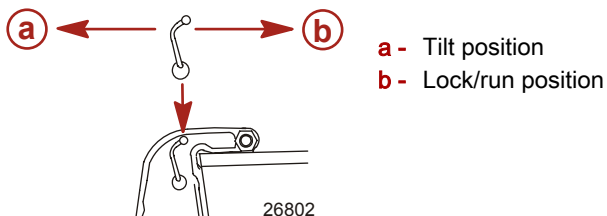

SHALLOW WATER OPERATION

When operating the boat in shallow water, the outboard can be adjusted and locked at a higher tilt angle. Operate the outboard at slow speed while tilted up for shallow water operation. Keep the cooling water intake holes submerged in the water and continue to check for water discharge from the water pump indicator hole.

TILTING OUTBOARD

Tilting To Full Up Position

1. Stop the engine. Move the tilt lock lever to the tilt position. Take hold of the top cowl grip and raise outboard to full tilt up position. Lock the outboard in place by moving the tilt lock lever to the lock/run position.

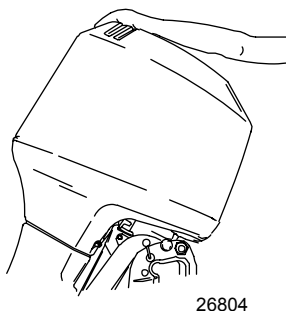

FEATURES AND CONTROLS

- Engage the tilt support lever by rotating knob to bring the tilt support lever upward.

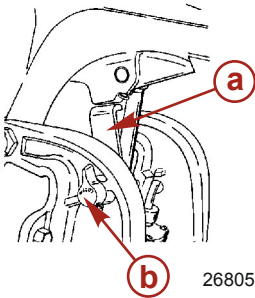

- a - Tilt support lever
- b - Knob

- Lower outboard to rest on the tilt support lever.

Lowering To Run Position

- Disengage the tilt support lever by raising the outboard off the tilt support lever and rotating the lever down. Lower the outboard.
- Move tilt lock lever to lock/run position.

SETTING THE OPERATING ANGLE OF THE OUTBOARD

The vertical operating angle of your outboard is adjusted by changing the position of the tilt pin in the five adjustment holes provided. The outboard should be locked against this tilt pin by setting the tilt lock lever to the lock/run position. Proper adjustment allows the boat to achieve optimum performance, stability and minimize steering effort.

NOTE: Refer to the following lists when adjusting the operating angle of your outboard.

The tilt pin should be adjusted so the outboard is positioned to run perpendicular to the water when the boat is running at full speed. This allows the boat to be driven parallel to the water.

FEATURES AND CONTROLS

Arrange passengers and load in the boat so the weight is distributed evenly.

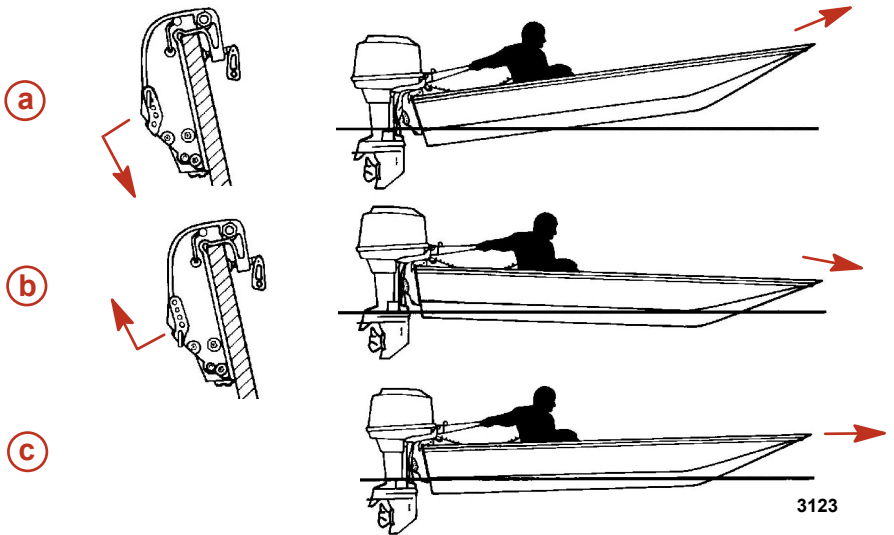

- a** - Too much angle (stern down - bow up)
- b** - Not enough angle (stern up - bow down)
- c** - Angle adjusted properly (bow slightly up)

Consider the following lists carefully when adjusting the operating angle of your outboard.

Adjusting the outboard close to the boat transom can:

- Lower the bow.
- Result in quicker planing off, especially with a heavy load or a stern heavy boat.
- Generally improve the ride in choppy water.
- Increase steering torque or pull to the right (with the normal right hand rotation propeller).
- In excess can lower the bow of some boats to a point where they begin to plow with their bow in the water while on plane. This can result in an unexpected turn in either direction (called bow steering, or over-steering) if any turn is attempted or if a significant wave is encountered.

Adjusting the outboard away from the boat transom can:

- Lift the bow out of the water.
- Generally increase top speed.
- Increase clearance over submerged objects or a shallow bottom.
- Increase steering torque or pull to the left at a normal installation height (with the normal right hand rotation propeller).

FEATURES AND CONTROLS

- In excess can cause boat porpoising (bouncing) or propeller ventilation.

Throttle Grip Friction Adjustment - Tiller Handle Models

Turn the wing nut to set and maintain the throttle at desired speed.

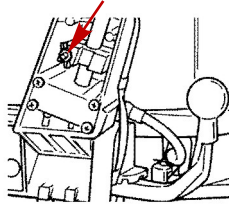

29172

Steering Friction Adjustment - Tiller Handle Models

▲ WARNING

Insufficient friction adjustment can cause serious injury or death due to loss of boat control. When setting the friction adjustment, maintain sufficient steering friction to prevent the outboard from steering into a full turn if the tiller handle or steering wheel is released.

Adjust this lever to achieve the desired steering friction (drag) on the tiller handle.

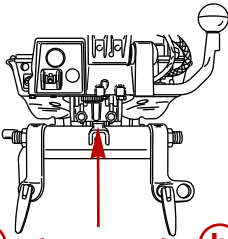

a - Tighten friction

b - Loosen friction

29173

FEATURES AND CONTROLS

Trim Tab Adjustment

Propeller steering torque will cause your boat to pull in one direction. This steering torque is a normal result from your outboard not trimmed with the propeller shaft parallel to the water surface. The trim tab can help to compensate for this steering torque in many cases and can be adjusted within limits to reduce any unequal steering effort.

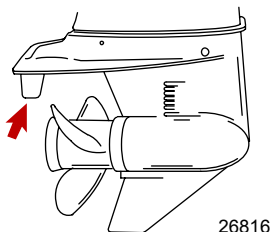

NOTE: Trim tab adjustment will have little effect reducing steering torque if the outboard is installed with the anti-ventilation plate approximately 50 mm (2 in.) or more above the boat bottom.

MODELS WITHOUT POWER TRIM

Operate your boat at normal cruising speed trimmed to desired position by installing the tilt pin in the desired tilt pin hole. Turn your boat left and right and note the direction the boat turns more easily.

If adjustment is necessary, loosen trim tab bolt and make small adjustments at a time. If the boat turns more easily to the left, move the trailing edge of trim tab to the left. If the boat turns more easily to the right, move the trailing edge of trim tab to the right. Retighten bolt and retest.

MODELS WITH POWER TRIM

Operate your boat at normal cruising speed, trimmed to desired position. Turn your boat left and right and note the direction the boat turns more easily.

If adjustment is necessary, loosen trim tab bolt and make small adjustments at a time. If the boat turns more easily to the left, move the trailing edge of trim tab to the left. If the boat turns more easily to the right, move the trailing edge of trim tab to the right. Retighten bolt and retest.

OPERATION

Important Daily Inspection Before Each Use

Any outboard mounted on the boat must have the mounting hardware inspected and checked to ensure that the hardware has not become loose. A decal on the transom bracket reminds the owner to check the fasteners securing the outboard to the transom before each use.

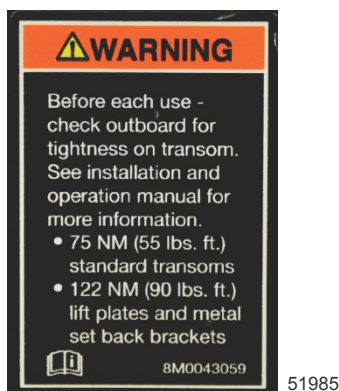

Decal on the transom bracket

Prestarting Check List

- Operator knows safe navigation, boating, and operating procedures.
- An approved personal flotation device of suitable size for each person aboard and readily accessible. It is the law.
- A ring-type life buoy or buoyant cushion designed to be thrown to a person in the water.
- Know the boat's maximum load capacity. Look at the boat capacity plate.
- Fuel supply OK.
- Oil supply (oil injection) OK.
- Arrange passengers and load in the boat so the weight is distributed evenly and everyone is seated in a proper seat.
- Tell someone where you are going and when you expect to return.
- It is illegal to operate a boat while under the influence of alcohol or drugs.
- Know the waters and area you will be boating; tides, currents, sand bars, rocks, and other hazards.
- Make the inspection checks listed in **Maintenance - Inspection and Maintenance Schedule**.

OPERATION

Operating in Freezing Temperatures

When using your outboard or having your outboard moored in freezing or near freezing temperatures, keep the outboard tilted down at all times so the gearcase is submerged. This prevents the trapped water in the gearcase from freezing and causing possible damage to the water pump and other components.

If there is a chance of ice forming on the water, the outboard should be removed and drained completely of water. If ice should form at the water level inside the outboard driveshaft housing, it will block water flow to the engine causing possible damage.

Operating in Saltwater or Polluted Water

We recommend that you flush the internal water passages of your outboard with fresh water after each use in salt or polluted water. This will prevent a buildup of deposits from clogging the water passages. Refer to **Maintenance - Flushing the Cooling System**.

If you keep your boat moored in the water, always tilt the outboard so the gearcase is completely out of water (except in freezing temperatures) when not in use.

Wash the outboard exterior and flush out the exhaust outlet of the propeller and gearcase with fresh water after each use. Each month, spray Mercury Precision or Quicksilver Corrosion Guard on external metal surfaces. Do not spray on corrosion control anodes as this will reduce the effectiveness of the anodes.

Effects of Elevation and Weather on Performance

The following conditions lower engine performance and cannot be compensated by the engine fuel or electronic management systems:

- Above sea level elevations
- High temperature
- Low barometric pressure
- High humidity

These conditions above reduce air density to the engine, which in turn lowers the following:

- Boost pressure on supercharged engines
- Horsepower and torque throughout the RPM range
- Peak RPM
- Cranking compression

EXAMPLE: An engine running at an elevation of 8,000 feet will have over a 30% power loss while a loss of engine power on a hot and humid day could be as much as 14%. These losses apply to normally aspirated and supercharged engines.

Compensating for power robbing conditions:

- Switch to lower pitch propeller.

OPERATION

- Change gear ratio.

Some boat performance can be improved by dropping to a lower pitch propeller, but engine performance will still remain lower. In some cases, a gear ratio reduction may be more beneficial. To optimize engine performance, prop the engine to allow it to operate at or near the top end of the recommended maximum RPM range at wide-open throttle with a normal boat load.

Other advantages to propeller or gear ratio changes:

- Reduces the possibility of detonation
- Enhances overall reliability and durability of the engine

Operating at High Elevations

IMPORTANT: To prevent serious damage to the engine caused by a lean fuel mixture, do not operate your outboard (if the jets were changed for high elevation) at a lower elevation unless the jets are changed again to correspond to the new elevation.

Operating your outboard at an elevation higher than 750 m (2500 ft) above sea level may require a carburetor jet change and/or different pitch propeller. Consult your dealer. This will reduce the normal performance loss experienced as a result of reduced oxygen in the air causing an overly rich fuel mixture.

Engine Break-in Procedure

IMPORTANT: Failure to follow the engine break-in procedures can result in poor performance throughout the life of the engine and can cause engine damage. Always follow break-in procedures.

MODELS WITH OIL INJECTION

Engine Break-in Fuel Mixture - Use a 50:1 (2%) gasoline/oil mixture in the first tank of fuel. Use of this fuel mixture combined with oil from the oil injection system will supply adequate lubrication during engine break-in.

Engine Break-in Procedure - Vary the throttle setting during the first hour of operation. During the first hour of operation, avoid remaining at constant speed for more than two minutes and avoid sustained wide-open throttle.

MODELS WITHOUT OIL INJECTION

Engine Break-in Fuel Mixture - Use a 25:1 (4%) gasoline/oil mixture in the first tank of fuel. After the break-in fuel mixture is used up, use a 50:1 (2%) gasoline/oil mixture.

Engine Break-in Procedure - Vary the throttle setting during the first hour of operation. During the first hour of operation, avoid remaining at constant speed for more than two minutes and avoid sustained wide-open throttle.

Starting the Engine

Before starting, read the **Prestarting Check List**, special operating instructions, and **Engine Break-in Procedure** in the **Operation** section.

OPERATION

NOTICE

Without sufficient cooling water, the engine, the water pump, and other components will overheat and suffer damage. Provide a sufficient supply of water to the water inlets during operation.

1. Lower the outboard to the vertical operating position. Make sure all cooling water intake holes are submerged.

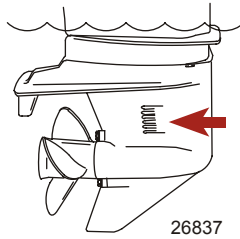

2. Open fuel tank vent screw (in filler cap) on manual venting type fuel tanks.

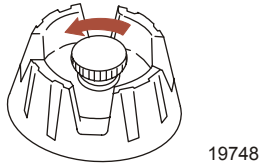

3. Connect the fuel line to the outboard.

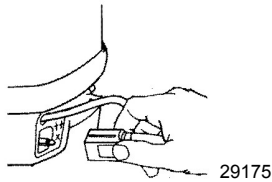

4. Squeeze the fuel line primer bulb several times until it feels firm.

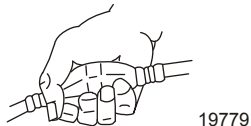

NOTE: The engine will not start unless the lanyard is set to the RUN position.

OPERATION

5. Set the lanyard stop switch to the RUN position. Refer to **General Information - Lanyard Stop Switch**.

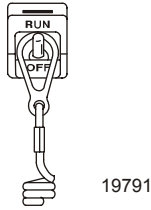

6. Shift outboard to neutral (N) position.

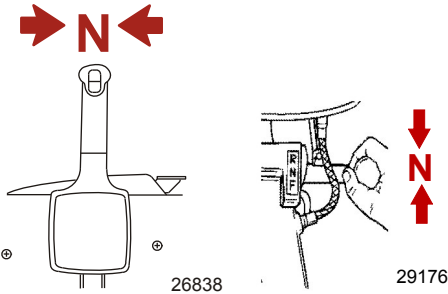

7. Model without power trim - Position tilt lock lever to the lock/run position.

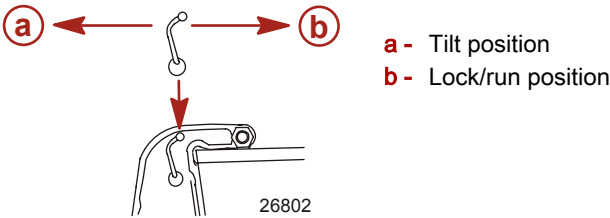

8. Tiller handle models - Align the throttle grip pointer to the START position.

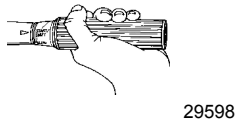

9. Starting a cold engine:

OPERATION

- a. Remote control models - Advance the fast idle speed lever of throttle only feature to an approximate halfway setting. After engine start up, immediately adjust neutral fast idle setting so engine speed drops below 2000 RPM. Return back to normal idle speed after engine is warmed up.

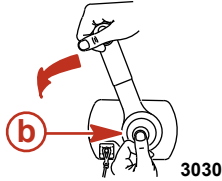
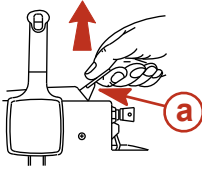

- a - Fast idle speed lever
b - Throttle only feature

- b. Manual start models - Depress fuel primer rapidly 4 to 6 times.

NOTE: For initial start of a new engine or first start after a prolonged storage, air may be present in primer. If this is the case, primer several times until fluid can be felt and then the normal 4 to 6 times.

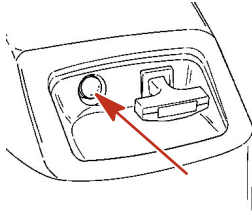

3076

10. Starting a flooded engine:

- a. Tiller handle models - Advance the throttle grip to full throttle speed. Without activating primer, start engine following starting procedure. Immediately start to reduce engine speed after engine starts.
- b. Remote control models - Advance the fast idle speed lever or throttle only feature to the full maximum position. Without activating the primer, crank engine for 10 seconds. Wait 30 seconds and repeat until engine starts. Immediately start to reduce engine speed after engine starts.

11. Turn ignition key to START position and start the engine. If engine is cold, push in on key to prime the engine while cranking. If engine fails to start in ten seconds, wait 30 seconds and try again. If engine begins to stall, reprime until engine is running smoothly.

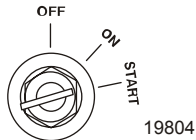

19804

OPERATION

▲ WARNING

Rapid acceleration can result in serious injury or death from being thrown within or out of the boat. Decrease engine speed before shifting into gear.

12. Manual start models - Pull starter rope.

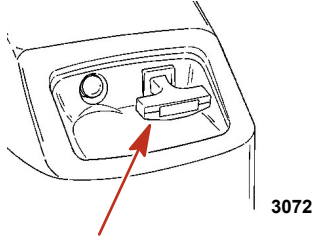

13. After engine starts, check for a steady stream of water flowing out of the water pump indicator hole.

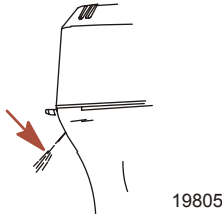

IMPORTANT: If no water is coming out of the water pump indicator hole, stop engine and check cooling water intake for obstruction. No obstruction may indicate a water pump failure or blockage in the cooling system. These conditions will cause the engine to overheat. Have the outboard checked by your dealer. Operating the engine while overheated may cause serious engine damage.

Gear Shifting

IMPORTANT: Observe the following:

- Never shift the outboard into or out of gear unless the engine speed is at idle. Shifting at higher than engine idle speed could cause damage to the gearcase.
- Do not shift the outboard into reverse when the forward motion of the boat is greater than a no wake speed. Shifting into reverse at higher boat speeds could cause the engine to stall, and in some situations, this could cause water to be drawn into the cylinders, resulting in severe engine damage.
- Do not shift the outboard into reverse when the engine is not running. Damage to the shift linkage could occur.
- The outboard has three gear shift positions: forward (F), neutral (N), and reverse (R).

OPERATION

- Remote control models—always stop at the neutral position to allow the engine idle speed to stabilize before shifting into another gear.
- Tiller handle models—reduce the engine speed to idle before shifting into another gear.
- Always shift the outboard into gear with a quick motion.
- After shifting the outboard into gear, advance the remote control handle or rotate the throttle grip (tiller handle) to increase the engine speed.

Stopping the Engine

1. **Remote control models** - Reduce the engine speed and shift the outboard to neutral position. Turn the ignition key to "OFF" position.

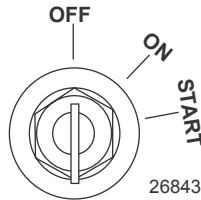

2. **Tiller handle models** - Reduce the engine speed and shift the outboard to neutral position. Push in the engine stop button or turn the ignition key to "OFF" position.

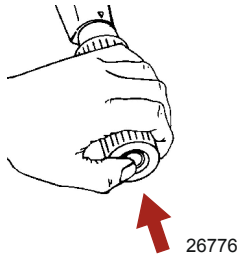

Emergency Starting

If the starter system fails, use the spare starter rope (provided) and follow procedure.

OPERATION

1. Remove flywheel cover.

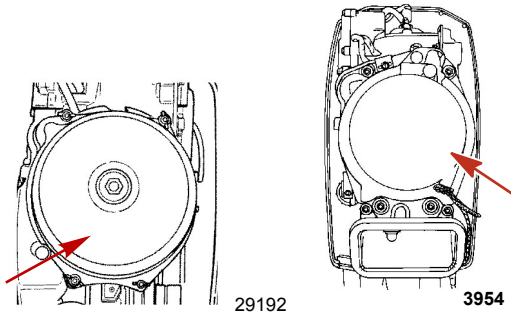

Electric start models

Manual start models

⚠ WARNING

The neutral-speed-protection device is inoperative when starting the engine with the emergency starter rope. Set the engine speed at idle and the gear shift in neutral to prevent the outboard from starting in gear.

2. Shift outboard to neutral (N) position.

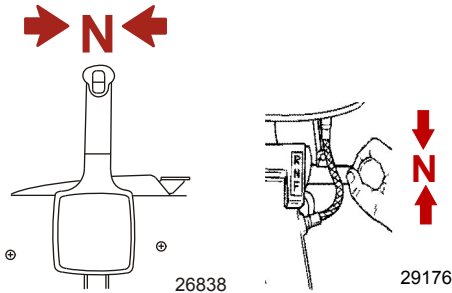

3. Turn the ignition key to "ON" position.

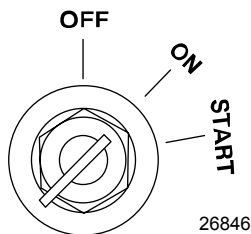

OPERATION

4. Set the lanyard stop switch to the "RUN" position. Refer to **General Information - Lanyard Stop Switch**.



19791

▲ WARNING

High voltage is present any time the key is turned on, especially when starting or operating the engine. Do not touch ignition components or metal test probes and stay clear of spark plug leads when performing live tests.

▲ WARNING

The exposed moving flywheel can cause serious injury. Keep your hands, hair, clothing, tools, and other objects away from engine when starting or running the engine. Do not attempt to reinstall the flywheel cover or top cowl when engine is running.

5. Place starter rope knot into the flywheel notch and wind the rope clockwise around the flywheel.

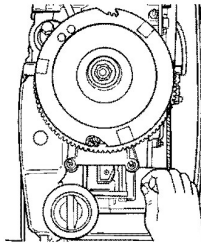

29193

OPERATION

6. If engine is cold, hold the fuel primer button in and pump up the fuel pressure with the fuel primer bulb.

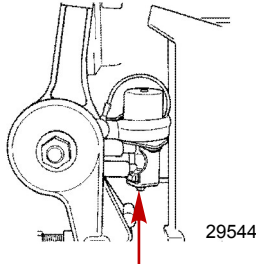

7. Pull the starter rope to start the engine.

Setting Trim Angle While Running Engine at Idle Speed

The exhaust relief hole on the outboard may become submerged if the outboard is trimmed full-in while running at idle speed. This will cause exhaust restriction, rough idle, excessive smoke, and fouled spark plugs. If this condition exists, trim the outboard up until the exhaust relief hole is out of the water. The outboard should be lowered for accelerating from a standing start or from idle speed.

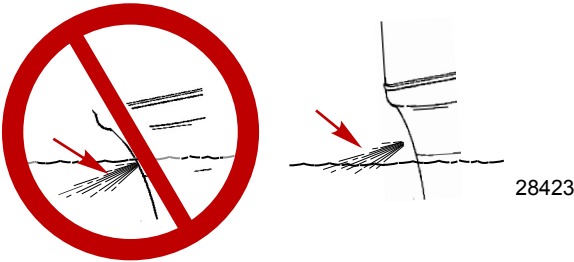

MAINTENANCE

Cleaning Care Recommendations

OUTBOARD CARE

To keep your outboard in the best operating condition, it is important that your outboard receive the periodic inspections and maintenance listed in the **Inspection and Maintenance Schedule**. We urge you to keep it maintained properly to ensure the safety of you and your passengers, and retain its dependability.

Record maintenance performed in the **Maintenance Log** at the back of this book. Save all maintenance work orders and receipts.

Selecting Replacement Parts For Your Outboard

We recommend using original Mercury Precision or Quicksilver replacement parts and Genuine Lubricants.

DO NOT USE CAUSTIC CLEANING CHEMICALS

IMPORTANT: Do not use caustic cleaning chemicals on the outboard power package. Some cleaning products contain strong caustic agents such as hull cleaners with hydrochloric acid. These cleaners can degrade some of the components they come in contact with including critical steering fasteners.

Damage to steering fasteners may not be obvious during visual inspection and this damage may lead to catastrophic failure. Some caustic cleaning chemicals may cause or accelerate corrosion. Exercise caution when using cleaning chemicals around the engine and follow the recommendations on the packaging of the cleaning product.

CLEANING GAUGES

IMPORTANT: Never use high-pressure water to clean gauges.

Routine cleaning of the gauges is recommended to prevent a buildup of salt and other environmental debris. Crystallized salt can scratch the gauge display lens when using a dry or damp cloth. Ensure that the cloth has a sufficient amount of fresh water to dissolve and remove salt or mineral deposits. Do not apply aggressive pressure on the display lens while cleaning.

When water marks cannot be removed with a damp cloth, mix a 50/50 solution of warm water and isopropyl alcohol to clean the display lens. **Do not use** acetone, mineral spirits, turpentine type solvents, or ammonia based cleaning products. The use of strong solvents or detergents may damage the coating, the plastics, or the rubber keys on the gauges. If the gauge has a sun cover available, it is recommended that the cover be installed when the unit is not in use to prevent UV damage to the plastic bezels and rubber keys.

CLEANING REMOTE CONTROLS

IMPORTANT: Never use high-pressure water to clean remote controls.

MAINTENANCE

Routine cleaning of the remote control external surfaces is recommended to prevent a buildup of salt and other environmental debris. Use a cloth towel which has a sufficient amount of fresh water to dissolve and remove salt or mineral deposits.

When water marks cannot be removed with a damp cloth, mix a 50/50 solution of warm water and isopropyl alcohol to clean the remote control. **Do not use acetone, mineral spirits, turpentine type solvents, or ammonia based cleaning products.** The use of strong solvents or detergents may damage the coating, the plastics, or the rubber components on the remote control.

CLEANING CARE FOR TOP AND BOTTOM COWLS

IMPORTANT: Dry wiping (wiping the plastic surface when it is dry) will result in minor surface scratches. Always wet the surface before cleaning. Do not use detergents containing hydrochloric acid. Follow the cleaning and waxing procedure.

Cleaning and Waxing Procedure



1. Before washing, rinse the cowls with clean water to remove dirt and dust that may scratch the surface.
2. Wash the cowls with clean water and a mild nonabrasive soap. Use a soft clean cloth when washing.
3. Dry thoroughly with a soft clean cloth.
4. Wax the surface using a nonabrasive automotive polish (polish designed for clear coat finishes). Remove the applied wax by hand using a clean soft cloth.
5. To remove minor scratches, use Mercury Marine Cowl Finishing Compound (92-859026K 1).

CLEANING CARE FOR THE POWERHEAD (SALTWATER USE)

If the outboard is operated in saltwater, remove the top cowl and flywheel cover. Inspect the powerhead and powerhead components for salt buildup. Wash off any salt buildup from the powerhead and powerhead components with fresh water. Keep water spray out of the air filter/intake and alternator. After washing, allow the powerhead and components to dry. Apply Quicksilver or Mercury Precision Lubricants Corrosion Guard spray on the external metal surfaces of the powerhead and powerhead components. Do not allow the Corrosion Guard spray to come in contact with the alternator drive belt or belt pulleys.

IMPORTANT: Do not allow lubricant or Corrosion Guard spray to come in contact with the alternator drive belt or the belt pulleys. The alternator drive belt could slip and be damaged if it becomes coated with any lubricant or Corrosion Guard spray.

MAINTENANCE

Tube Ref No.	Description	Where Used	Part No.
 120 	Corrosion Guard	External metal surfaces of the powerhead and powerhead components.	92-802878 55

Inspection and Maintenance Schedule

DAILY CHECKS

- Check the engine oil level
- Check the lanyard stop switch
- Inspect the fuel system for leaks
- Inspect the engine tightness on the transom
- Check the steering system for binding
- Check the propeller for damage
- Inspect the hydraulic steering fittings and hoses for leaks or signs of damage, if equipped
- Check the hydraulic steering fluid level, if equipped

AFTER EACH USE

- Wash the power package exterior with fresh water
- Flush the outboard cooling system, saltwater or brackish water only

ANNUALLY OR 100 HOURS

- Grease the engine, if applicable
- Change the engine oil and filter, if equipped
- Inspect the thermostat, saltwater or brackish water only
- Add Quickleen to the fuel tank, once per year, per engine
- Apply anti-seize to the spark plug threads
- Replace the gear lubricant
- Inspect the corrosion control anodes
- Lubricate the propeller shaft splines
- Replace all filters on the suction side of the fuel system—dealer item
- Lubricate the driveshaft splines—dealer item
- Check the tightness on all the fasteners—dealer item
- Check the torque of the outboard mounting hardware—dealer item
- Check the battery condition and tightness of the battery cable connection—dealer item

THREE YEARS OR 300 HOURS

- Replace the spark plugs
- Replace the water pump impeller—dealer item

MAINTENANCE

- Inspect the carbon fiber reeds—dealer item
- Inspect the wire harness connectors—dealer item
- Check the remote control cable adjustment, if applicable—dealer item
- Replace the high-pressure fuel filter—dealer item
- Replace the accessory drive belt—dealer item
- Check the power trim fluid level—dealer item
- Inspect the engine motor mounts—dealer item

Flushing the Cooling System

Flush the internal water passages of the outboard with fresh water after each use in salt, polluted, or muddy water. This will help prevent a buildup of deposits from clogging the internal water passages.

Use a Mercury Precision or Quicksilver accessory (or equivalent) flushing attachment.

▲ WARNING

Rotating propellers can cause serious injury or death. Never operate the boat out of the water with a propeller installed. Before installing or removing a propeller, place the drive unit in neutral and engage the lanyard stop switch to prevent the engine from starting. Place a block of wood between the propeller blade and the anti-ventilation plate.

1. Remove propeller. Refer to **Propeller Replacement**. Install the flushing attachment so the rubber cups fit tightly over the cooling water intake.

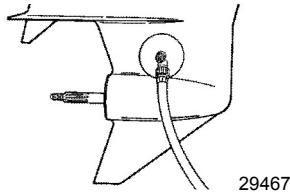

2. Attach a water hose to the flushing attachment. Turn on the water and adjust the flow so water is leaking around the rubber cups to ensure the engine receives an adequate supply of cooling water.

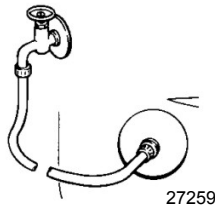

3. Start the engine and run it at idle speed in neutral shift position.

MAINTENANCE

IMPORTANT: Do not run engine above idle when flushing.

4. Adjust water flow (if necessary) so excess water continues leaking out from around the rubber cups to ensure the engine is receiving an adequate supply of cooling water.

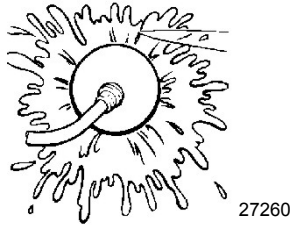

5. Check for a steady stream of water flowing out of the water pump indicator hole. Continue flushing the outboard for 3 to 5 minutes, carefully monitoring water supply at all times.
6. Stop the engine, turn off the water, and remove the flushing attachment. Reinstall the propeller.

Flushing the Cooling System - Models with Accessory Hose Flush Attachment

Flush the internal water passages of the outboard with fresh water after each use in salt, polluted, or muddy water. This will help prevent a build up of deposits from clogging the internal water passages.

1. Thread a water hose into hose adapter.
2. Remove dust cover and push the hose adapter into the flush connector until it locks (snaps) in place.

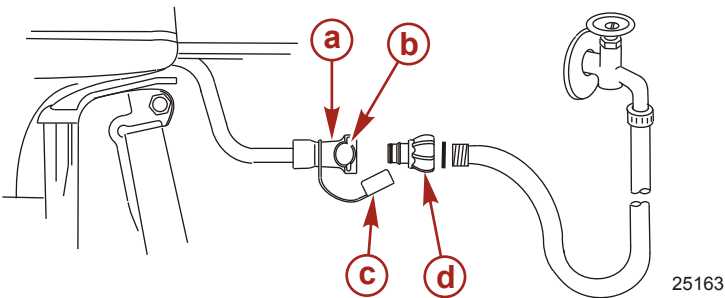

- a** - Flush connector
- b** - Button
- c** - Hose adapter
- d** - Dust cover

MAINTENANCE

NOTE: Engine can be stopped or running at idle speed in neutral when flushing the cooling system. Do not flush engine using a water source that exceeds 6.5 kPa (45 psi).

3. Turn on the water and flush the cooling system for a minimum of 3 minutes.

NOTE: The hose adapter shuts off the water flow whenever it is disconnected from the flush connector.

4. Push button in to release the hose adapter.
5. Reinstall dust cover.

FREEZING TEMPERATURE

The water should be drained out of the engine flush hose if there is a chance of freezing temperature. Drain water as follows:

1. Remove water hose from the hose adapter.
2. Insert the adapter only into the flush connector.
3. Tilt the outboard up until all the water has drained out of the hose.

Top Cowl Removal and Installation

REMOVAL

1. Unlock the rear latch by pushing lever down.

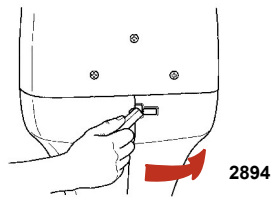

2. Lift rear of cowl and disengage front hook.

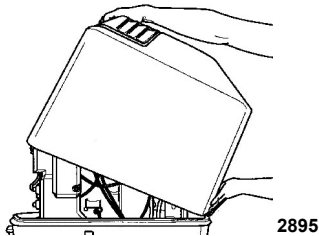

INSTALLATION

1. Engage the front hook and push cowl back over the cowl seal.
2. Push cowl down and move the rear latch lever up to lock.

MAINTENANCE

Battery Inspection

The battery should be inspected at periodic intervals to ensure proper engine starting capability.

IMPORTANT: Read the safety and maintenance instructions which accompany your battery.

1. Turn off the engine before servicing the battery.
2. Ensure the battery is secure against movement.
3. Battery cable terminals should be clean, tight, and correctly installed. Positive to positive and negative to negative.
4. Ensure the battery is equipped with a nonconductive shield to prevent accidental shorting of battery terminals.

Fuel System

▲ WARNING

Fuel is flammable and explosive. Ensure that the key switch is off and the lanyard is positioned so that the engine cannot start. Do not smoke or allow sources of spark or open flame in the area while servicing. Keep the work area well ventilated and avoid prolonged exposure to vapors. Always check for leaks before attempting to start the engine, and wipe up any spilled fuel immediately.

Before servicing any part of the fuel system, stop the engine and disconnect the battery. Drain the fuel system completely. Use an approved container to collect and store fuel. Wipe up any spillage immediately. Material used to contain spillage must be disposed of in an approved receptacle. Any fuel system service must be performed in a well-ventilated area. Inspect any completed service work for sign of fuel leakage.

FUEL LINE INSPECTION

Visually inspect the fuel line and primer bulb for cracks, swelling, leaks, hardness, or other signs of deterioration or damage. If any of these conditions are found, the fuel line or primer bulb must be replaced.

FUEL LINE FILTER

Inspect the fuel line filter. If the filter appears to be contaminated, remove and replace.

MAINTENANCE

IMPORTANT: Visually inspect for fuel leakage from the filter connections by squeezing the primer bulb until firm, forcing fuel into the filter.

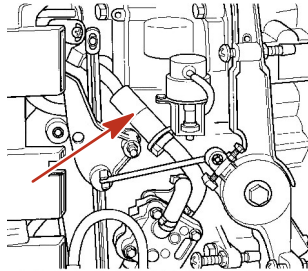

2896

FUEL LINE FILTER - NON OIL INJECTED MODELS

Inspect the sight bowl for water accumulation. The sight bowl is equipped with a float that floats on water. Also inspect the filter element for sediment. Clean filter as follows:

Removal

1. Turn the engine off.
2. Turn off cap and remove the sight bowl.
3. Remove the filter element and wash with cleaning solvent.

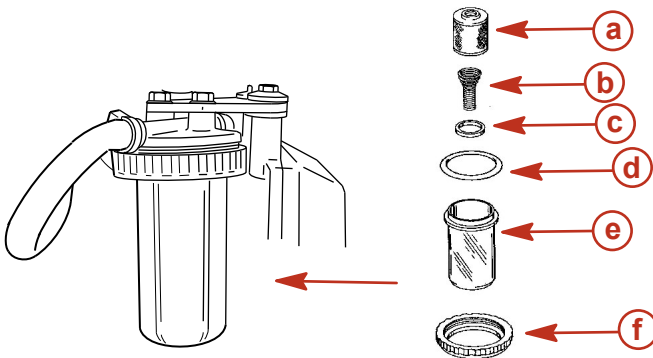

3128

- a** - Filter element
- b** - Spring
- c** - Float
- d** - O-ring seal
- e** - Sight bowl
- f** - Cap

MAINTENANCE

Installation

1. Reinstall filter element (open end up).
2. Place O-ring seal onto the sight bowl and reinstall sight bowl with cap.
3. Tighten cap securely.

IMPORTANT: Visually inspect for fuel leakage from the filter by squeezing the primer bulb until firm, forcing fuel into the filter.

Steering Link Rod Fasteners

IMPORTANT: The steering link rod that connects the steering cable to the engine must be fastened using special washer head bolt ("a" - Part Number 10-856680) and self-locking nylon insert locknuts ("c" & "d" - Part Number 11-826709113). These locknuts must never be replaced with common nuts (nonlocking) as they will work loose and vibrate off, freeing the link rod to disengage.

⚠ WARNING

Improper fasteners or improper installation procedures can result in loosening or disengagement of the steering link rod. This can cause a sudden, unexpected loss of boat control, resulting in serious injury or death due to occupants being thrown within or out of the boat. Always use required components and follow instructions and torque procedures.

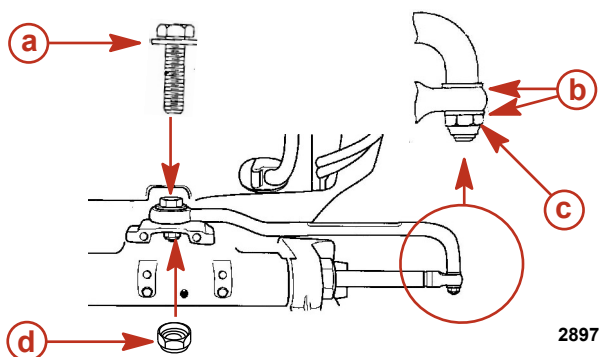

- a - Special washer head bolt (10-856680)
- b - Flat washers
- c - Nylon insert locknut (11-826709113)
- d - Nylon insert locknut (11-826709113)

Description	Nm	lb-in.	lb-ft
Special washer head bolt	27	-	20
Nylon insert locknut "d"	27	-	20

MAINTENANCE

Description	Nm	lb-in.	lb-ft
Nylon insert locknut "c"	Tighten until seats, then back off 1/4 turn		

Assemble steering link rod to steering cable with two flat washers and nylon insert locknut. Tighten locknut until it seats, then back nut off 1/4 turn.

Assemble steering link rod to engine with special washer head bolt and locknut. First torque special washer head bolt, then torque locknut to specifications.

Fuse Replacement

IMPORTANT: An ATC fuse has the fuse element enclosed or sealed inside the plastic housing. This type of fuse must be used for marine applications. Marine applications are exposed to environments that may have the potential to accumulate explosive vapors. ATO fuses have exposed elements and should never be used in marine applications.

IMPORTANT: Always carry spare ATC 20-amp fuses.

The electric starting circuit is protected from overload by an ATC 20-amp fuse. If the fuse is blown, the electric starter motor will not operate. Try to locate and correct the cause of the overload. If the cause is not found, the fuse may blow again. Replace fuse with a fuse of the same rating

Open the fuse holder and look at the silver colored band inside the fuse. If band is broken, replace the fuse with a new fuse with the same rating.

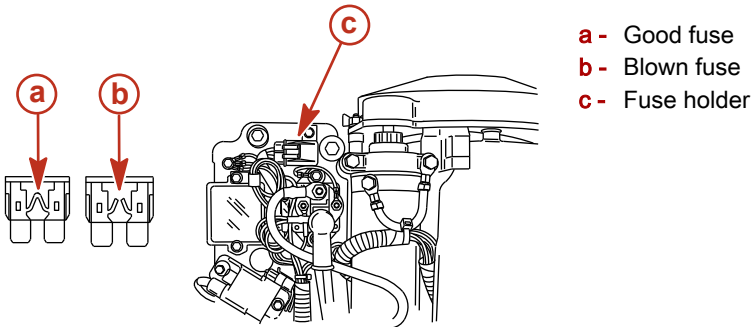

2898

Corrosion Control Anode

Your outboard has corrosion control anodes at different locations. An anode helps protect the outboard against galvanic corrosion by sacrificing its metal to be slowly corroded instead of the outboard metals.

Each anode requires periodic inspection, especially in saltwater which will accelerate the erosion. To maintain this corrosion protection, always replace the anode before it is completely eroded. Never paint or apply a protective coating on the anode as this will reduce effectiveness of the anode.

MAINTENANCE

The gearcase has two corrosion control anodes, one on each side. A third anode is installed on the bottom of the transom bracket assembly.

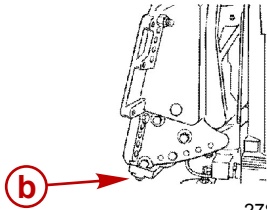
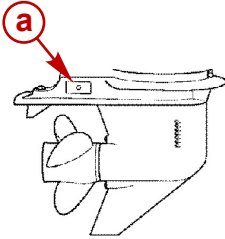

- a - Anode (2) on each side of gearcase
- b - Anode on transom bracket assembly

27844

Propeller Replacement

⚠ WARNING

Rotating propellers can cause serious injury or death. Never operate the boat out of the water with a propeller installed. Before installing or removing a propeller, place the drive unit in neutral and engage the lanyard stop switch to prevent the engine from starting. Place a block of wood between the propeller blade and the anti-ventilation plate.

1. Shift outboard to neutral (N) position.

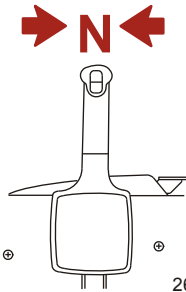

26838

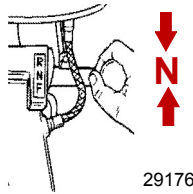

29176

IMPORTANT: Refer to Spark Plug Inspection and Replacement for removing spark plug leads.

2. Remove spark plug leads to prevent engine from starting.

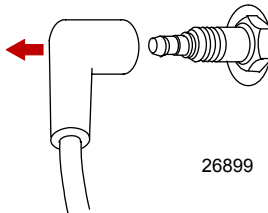

26899

MAINTENANCE

3. Straighten the bent tabs on the propeller nut retainer.

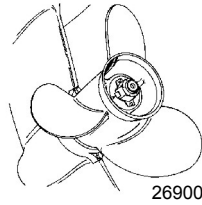

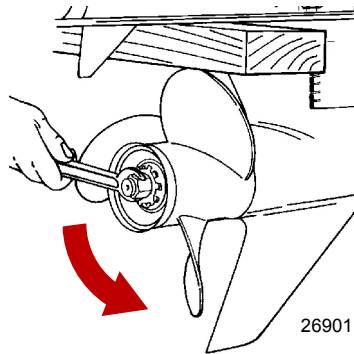

4. Place a block of wood between gearcase and propeller to hold propeller and remove propeller nut.

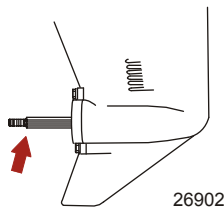

5. Pull propeller straight off shaft. If propeller is seized to the shaft and cannot be removed, have the propeller removed by an authorized dealer.
6. Coat the propeller shaft with Quicksilver or Mercury Extreme Grease or 2-4-C with PTFE.



Tube Ref No.	Description	Where Used	Part No.
	Extreme Grease	Propeller shaft	8M0071842
95 	2-4-C with PTFE	Propeller shaft	92-802859A 1

MAINTENANCE

IMPORTANT: To prevent the propeller hub from corroding and seizing to the propeller shaft (especially in saltwater), always apply a coat of the recommended lubricant to the entire propeller shaft at the recommended maintenance intervals and also each time the propeller is removed.

- Flo-Torq I drive hub propellers - Install thrust washer, propeller, continuity washer, thrust hub, propeller nut retainer, and propeller nut onto the shaft.

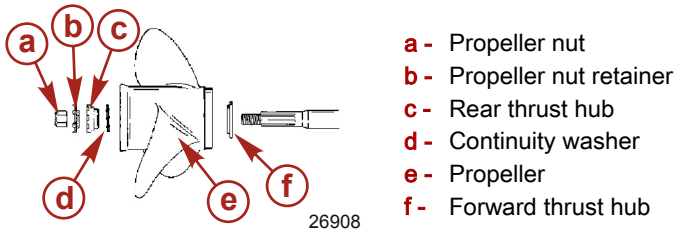

- Flo-Torq II drive hub propellers - Install forward thrust hub, replaceable drive sleeve, propeller, thrust hub, propeller nut retainer, and propeller nut onto the shaft.

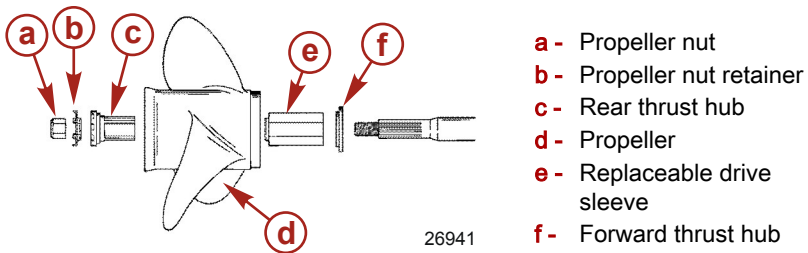

- Place a block of wood between gearcase and propeller and torque propeller nut to specifications.

Description	Nm	lb-in.	lb-ft
Propeller nut	75	-	55

- Secure propeller nut by bending three of the tabs into the thrust hub grooves.

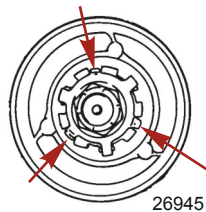

MAINTENANCE

Spark Plug Inspection and Replacement

⚠ WARNING

Damaged spark plug boots may emit sparks that can ignite fuel vapors under the engine cowl, resulting in serious injury or death from a fire or explosion. To avoid damaging the spark plug boots, do not use any sharp object or metal tool to remove the spark plug boots.

1. Remove the spark plug leads. Twist the rubber boots slightly and pull off.

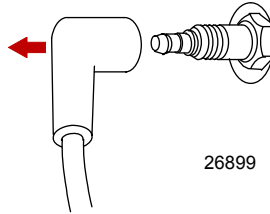

2. Remove the spark plugs to inspect. Replace spark plug if electrode is worn or the insulator is rough, cracked, broken, blistered, or fouled.

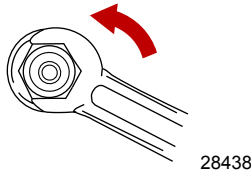

3. Set the spark plug gap to specifications, if applicable.

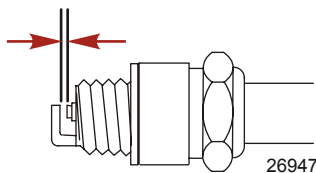

Spark Plug Gap

NGK BPZ8H-N-10	1.0 mm (0.040 in.)
NGK BUZHW-2	Surface gap



4. Before installing spark plugs, clean off any dirt on the spark plug seats. Install plugs finger-tight, and then tighten 1/4 turn or torque to specifications.

Description	Nm	lb-in.	lb-ft
Spark plug	27	–	20

MAINTENANCE

Lubrication Points

1. Lubricate the following with Quicksilver or Mercury Extreme Grease or 2-4-C with PTFE.

Tube Ref No.	Description	Where Used	Part No.
	Extreme Grease	Propeller shaft	8M0071842
	2-4-C with PTFE	Propeller shaft	92-802859A 1

- Propeller Shaft - Refer to **Propeller Replacement** for removal and installation of the propeller. Coat the entire propeller shaft with lubricant to prevent the propeller hub from corroding and seizing to the shaft.

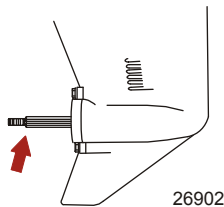

2. Lubricate the following with Quicksilver or Mercury Precision Lubricants 2-4-C with PTFE.

Tube Ref No.	Description	Where Used	Part No.
	2-4-C with PTFE	Swivel bracket, tilt support lever, tilt tube, tiller handle, steering cable grease fitting	92-802859A 1

- Swivel Bracket - Lubricate through fitting.
- Tilt Support Lever - Lubricate through fitting.

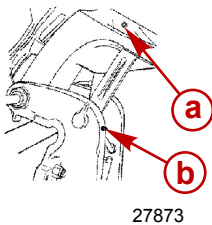

- a** - Swivel bracket
- b** - Tilt support lever

MAINTENANCE

- Tilt Tube - Lubricate through fitting.

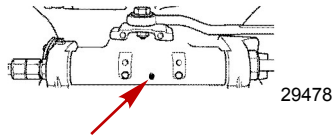

- Tiller Handle - Lubricate through fitting.

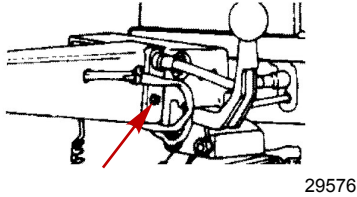

- Steering Cable Grease Fitting (If equipped) - Rotate steering wheel to fully retract the steering cable end into the outboard tilt tube. Lubricate through fitting.

⚠ WARNING

Incorrect cable lubrication can cause hydraulic lock, leading to serious injury or death from loss of boat control. Completely retract the end of the steering cable before applying lubricant.

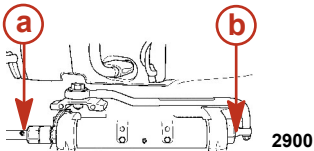

- a** - Fitting
- b** - Steering cable end

3. Lubricate the following with light weight oil.

- Steering Link Rod Pivot Points - Lubricate pivot points.

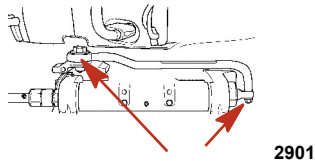

MAINTENANCE

Checking Power Trim Fluid

1. Tilt outboard to the full up position and engage the tilt support lever.

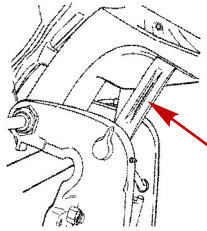

27877

2. Remove fill cap and check fluid level. The fluid level should be even with the bottom of the fill hole. Add Quicksilver or Mercury Precision Lubricants Power Trim & Steering Fluid. If not available, use automotive (ATF) automatic transmission fluid.

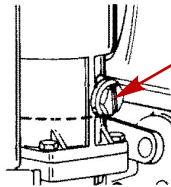

29588

Gearcase Lubrication

When adding or changing gearcase lubricant, visually check for the presence of water in the lubricant. If water is present, it may have settled to the bottom and will drain out prior to the lubricant, or it may be mixed with the lubricant, giving it a milky colored appearance. If water is noticed, have the gearcase checked by your dealer. Water in the lubricant may result in premature bearing failure or, in freezing temperatures, will turn to ice and damage the gearcase.

Examine the drained gearcase lubricant for metal particles. A small amount of metal particles indicates normal gear wear. An excessive amount of metal filings or larger particles (chips) may indicate abnormal gear wear and should be checked by an authorized dealer.

DRAINING GEARCASE

1. Place the outboard in a vertical operating position.
2. Place a drain pan below the outboard.

MAINTENANCE

3. Remove the vent plugs and fill/drain plug and drain the lubricant.

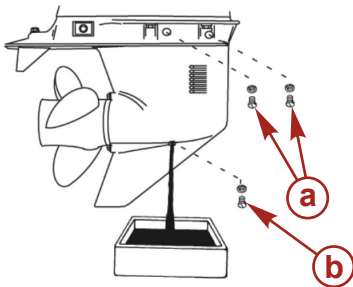

26977

GEARCASE LUBRICANT CAPACITY

Gearcase lubricant capacity is approximately 665 ml (22.5 fl oz).

GEARCASE LUBRICANT RECOMMENDATION

Mercury or Quicksilver Premium or High Performance Gear Lubricant.

CHECKING LUBRICANT LEVEL AND FILLING GEARCASE

1. Place the outboard in a vertical operating position.
2. Remove the front vent plug and rear vent plug.
3. Remove the fill/drain plug. Place the lubricant tube into the fill/drain plug hole and add lubricant until it appears at the front vent hole. At this time install the front vent plug and sealing washer.

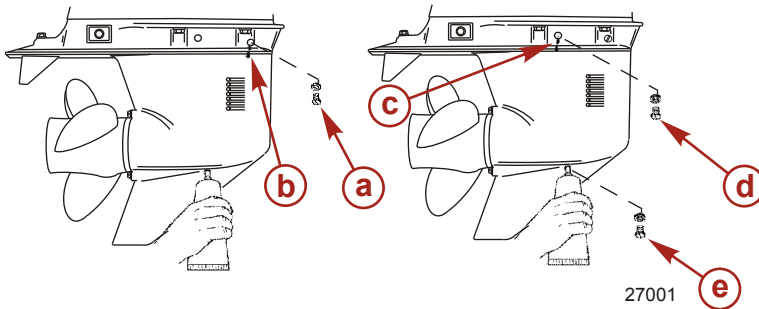

27001

- a - Front vent plug
- b - Front vent hole
- c - Rear vent hole
- d - Rear vent plug
- e - Fill/drain plug

4. Continue adding the lubricant until it appears at the rear vent hole.

MAINTENANCE

5. Stop adding the lubricant. Install the rear vent plug and sealing washer before removing lubricant tube.
6. Remove the lubricant tube and install cleaned fill/drain plug and sealing washer.

Submerged Outboard

A submerged outboard will require service within a few hours by an authorized dealer once the outboard is recovered from the water. This immediate attention by a servicing dealer is necessary once the engine is exposed to the atmosphere to minimize internal corrosion damage to the engine.

STORAGE

Storage Preparation

The major consideration in preparing your outboard for storage is to protect it from rust, corrosion, and damage caused by freezing of trapped water.

The following storage procedures should be followed to prepare your outboard for out of season storage or prolonged storage (two months or longer).

NOTICE

Without sufficient cooling water, the engine, the water pump, and other components will overheat and suffer damage. Provide a sufficient supply of water to the water inlets during operation.

FUEL SYSTEM

IMPORTANT: Gasoline containing alcohol (ethanol or methanol) can cause a formation of acid during storage and can damage the fuel system. If the gasoline being used contains alcohol, it is advisable to drain as much of the remaining gasoline as possible from the fuel tank, remote fuel line, and engine fuel system.

Fill the fuel tank and engine fuel system with treated (stabilized) fuel to help prevent formation of varnish and gum. Proceed with the following instructions.

- Portable fuel tank - Pour the required amount of gasoline stabilizer (follow instructions on container) into fuel tank. Tip fuel tank back and forth to mix stabilizer with the fuel.
- Permanently installed fuel tank - Pour the required amount of gasoline stabilizer (follow instructions on container) into a separate container and mix with approximately 1 liter (1 U.S. quart) of gasoline. Pour this mixture into fuel tank.
- Place the outboard in water or connect flushing attachment for circulating cooling water. Run the engine for ten minutes to fill the engine fuel system.



Flushing Device	91-44357Q 2
 <p>9192</p>	Attaches to the water intakes; provides a fresh water connection when flushing the cooling system or operating the engine.

Protecting External Outboard Components

- Lubricate all outboard components listed in **Maintenance - Inspection and Maintenance Schedule**.

STORAGE

- Touch up any paint nicks. See your dealer for touch-up paint.
- Spray Quicksilver or Mercury Precision Lubricants Corrosion Guard on external metal surfaces (except corrosion control anodes).

Tube Ref No.	Description	Where Used	Part No.
 120 	Corrosion Guard	External metal surfaces	92-802878 55

Protecting Internal Engine Components

NOTE: Make sure the fuel system has been prepared for storage. Refer to Fuel System, preceding.

IMPORTANT: Refer to Maintenance - Spark Plug Inspection and Replacement for correct procedure for removing spark plug boots.

- Place the outboard in water or connect flushing attachment for circulating cooling water. Start the engine and let it run in neutral to warm up.
- With engine running at fast idle, stop the fuel flow by kinking the remote fuel line. When engine begins to stall, quickly spray Quicksilver or Mercury Precision Lubricants Storage Seal into carburetor until engine stops from lack of fuel.
- Remove the spark plugs and inject a five second spray of storage seal around the inside of the cylinder.
- Rotate the flywheel manually several times to distribute the storage seal in the cylinder. Reinstall spark plug.

Gearcase

- Drain and refill the gearcase lubricant (refer to **Gearcase Lubricant**).

Draining Hose Flush Attachment (If Equipped)

- If the outboard is stored in freezing temperatures, the hose and flush attachment should be drained of water. Refer to **Maintenance - Flushing the Cooling System - Models with Hose Flush Attachment**.

Positioning Outboard for Storage

Store outboard in an upright (vertical) position to allow water to drain out of the outboard.

NOTICE

Storing the outboard in a tilted position can damage the outboard. Water trapped in the cooling passages or rain water collected in the propeller exhaust outlet in the gearcase can freeze. Store the outboard in the full down position.

Battery Storage

- Follow the battery manufacturer's instructions for storage and charging.

STORAGE

- Remove the battery from the boat and check water level. Charge if necessary.
- Store the battery in a cool, dry place.
- Periodically check the water level and charge the battery during storage.

TROUBLESHOOTING

Starter Motor Will Not Crank the Engine

POSSIBLE CAUSES

- Blown 20-amp fuse in the starting circuit. Refer to **Maintenance**.
- Outboard is not shifted to neutral position.
- Weak battery or battery connections are loose or corroded.
- Ignition key switch failure.
- Wiring or electrical connection faulty.
- Starter motor solenoid or slave solenoid failure.

Engine Will Not Start

POSSIBLE CAUSES

- Lanyard stop switch not in "RUN" position.
- Incorrect starting procedure. Refer to **Operation** section.
- Old or contaminated gasoline.
- Engine flooded. Refer to **Operation** section.
- Fuel is not reaching the engine.
 - a. Fuel tank is empty.
 - b. Fuel tank vent not open or restricted.
 - c. Fuel line is disconnected or kinked.
 - d. Primer bulb not squeezed.
 - e. Primer bulb check valve is faulty.
 - f. Fuel filter is obstructed. Refer to **Maintenance** section.
 - g. Fuel pump failure.
 - h. Fuel tank filter obstructed.
- Ignition system component failure.
- Spark plugs fouled or defective. Refer to **Maintenance** section.

Engine Runs Erratically

POSSIBLE CAUSES

- Spark plugs fouled or defective. Refer to **Maintenance** section.
- Incorrect setup and adjustments.
- Fuel is being restricted to the engine.
 - Engine fuel filter is obstructed. Refer to **Maintenance** section.
 - Fuel tank filter obstructed.
 - Stuck anti-siphon valve on built in fuel tank.
 - Fuel line is kinked or pinched.
- Fuel pump failure.

TROUBLESHOOTING

- Ignition system component failure.

Performance Loss

POSSIBLE CAUSES

- Throttle not fully open.
- Damaged or improper size propeller.
- Incorrect engine timing, adjustments, or setup.
- Boat overloaded or load improperly distributed.
- Excessive water in bilge.
- Boat bottom is dirty or damaged.

Battery Will Not Hold Charge

POSSIBLE CAUSES

- Battery connections are loose or corroded.
- Low electrolyte level in battery.
- Worn out or inefficient battery.
- Excessive use of electrical accessories.
- Defective rectifier, alternator, or voltage regulator.

OWNER SERVICE ASSISTANCE

Service Assistance

LOCAL REPAIR SERVICE

If you need service for your Mercury-outboard-powered boat, take it to your authorized dealer. Only authorized dealers specialize in Mercury products and have factory-trained mechanics, special tools and equipment, and genuine Quicksilver parts and accessories to properly service your engine.

NOTE: *Quicksilver parts and accessories are engineered and built by Mercury Marine specifically for your power package.*

SERVICE AWAY FROM HOME

If you are away from your local dealer and the need arises for service, contact the nearest authorized dealer. If, for any reason, you cannot obtain service, contact the nearest Regional Service Center. Outside the United States and Canada, contact the nearest Marine Power International Service Center.

STOLEN POWER PACKAGE

If your power package is stolen, immediately advise the local authorities and Mercury Marine of the model and serial numbers and to whom the recovery is to be reported. This information is maintained in a database at Mercury Marine to aid authorities and dealers in the recovery of stolen power packages.

ATTENTION REQUIRED AFTER SUBMERSION

1. Before recovery, contact an authorized Mercury dealer.
2. After recovery, immediate service by an authorized Mercury dealer is required to reduce the possibility of serious engine damage.

REPLACEMENT SERVICE PARTS

WARNING

Avoid fire or explosion hazard. Electrical, ignition, and fuel system components on Mercury Marine products comply with federal and international standards to minimize risk of fire or explosion. Do not use replacement electrical or fuel system components that do not comply with these standards. When servicing the electrical and fuel systems, properly install and tighten all components.

Marine engines are expected to operate at or near full throttle for most of their lives. They are also expected to operate in both fresh and saltwater environments. These conditions require numerous special parts.

PARTS AND ACCESSORIES INQUIRIES

Direct any inquiries concerning genuine Mercury Precision Parts® or Quicksilver Marine Parts and Accessories® to a local authorized dealer. Dealers have the proper systems to order parts and accessories, if they are not in stock. **Engine model** and **serial number** are required to order correct parts.

OWNER SERVICE ASSISTANCE

RESOLVING A PROBLEM

Satisfaction with your Mercury product is important to your dealer and to us. If you ever have a problem, question or concern about your power package, contact your dealer or any authorized Mercury dealership. If you need additional assistance:

1. Talk with the dealership's sales manager or service manager.
2. If your question, concern, or problem cannot be resolved by your dealership, please contact the Mercury Marine Service Office for assistance. Mercury Marine will work with you and your dealership to resolve all problems.

The following information will be needed by the Customer Service:

- Your name and address
- Your daytime telephone number
- The model and serial numbers of your power package
- The name and address of your dealership
- The nature of the problem

CONTACT INFORMATION FOR MERCURY MARINE CUSTOMER SERVICE

For assistance, call, fax, or write to the geographic office in your area. Please include your daytime telephone number with mail and fax correspondence.

United States, Canada		
Telephone	English +1 920 929 5040 Français +1 905 636 4751	Mercury Marine W6250 Pioneer Road P.O. Box 1939 Fond du Lac, WI 54936-1939
Fax	English +1 920 929 5893 Français +1 905 636 1704	
Website	www.mercurymarine.com	

Australia, Pacific		
Telephone	+61 3 9791 5822	Brunswick Asia Pacific Group 41-71 Bessemer Drive Dandenong South, Victoria 3175 Australia
Fax	+61 3 9706 7228	

Europe, Middle East, Africa		
Telephone	+32 87 32 32 11	Brunswick Marine Europe Parc Industriel de Petit-Rechain B-4800 Verviers, Belgium
Fax	+32 87 31 19 65	

OWNER SERVICE ASSISTANCE

Mexico, Central America, South America, Caribbean		
Telephone	+1 954 744 3500	Mercury Marine 11650 Interchange Circle North Miramar, FL 33025 U.S.A.
Fax	+1 954 744 3535	

Japan		
Telephone	+072 233 8888	Kisaka Co., Ltd. 4-130 Kannabecho, Sakai-ku Sakai-shi, Osaka 590-0984, Japan
Fax	+072 233 8833	

Asia, Singapore		
Telephone	+65 65466160	Brunswick Asia Pacific Group T/A Mercury Marine Singapore Pte Ltd 29 Loyang Drive Singapore, 508944
Fax	+65 65467789	

Ordering Literature

Before ordering literature, have the following information about your power package available:

Model		Serial Number	
Horsepower		Year	

UNITED STATES AND CANADA

For additional literature for your Mercury Marine power package, contact your nearest Mercury Marine dealer or contact:

Mercury Marine		
Telephone	Fax	Mail
(920) 929-5110 (USA only)	(920) 929-4894 (USA only)	Mercury Marine Attn: Publications Department P.O. Box 1939 Fond du Lac, WI 54936-1939

OUTSIDE THE UNITED STATES AND CANADA

Contact your nearest Mercury Marine authorized service center to order additional literature that is available for your particular power package.

OWNER SERVICE ASSISTANCE

Submit the following order form with payment to:	Mercury Marine Attn: Publications Department W6250 Pioneer Road P.O. Box 1939 Fond du Lac, WI 54936-1939
--	--

Ship To: (Copy this form and print or type—This is your shipping label)	
Name	
Address	
City, State, Province	
ZIP or postal code	
Country	

Quantity	Item	Stock Number	Price	Total
			.	.
			.	.
			.	.
			.	.
			.	.
Total Due			.	.

ENGINE INSTALLATION

Mercury Marine Validated Engine Mounting Hardware

IMPORTANT: Mercury Marine provides validated fasteners and installation instructions, including torque specifications, with all of our outboards so they can be properly secured to boat transoms. Improper installation of the outboard can cause performance and reliability issues that can lead to safety concerns. Follow all of the instructions relating to the outboard installation. **DO NOT** mount any other accessory onto the boat with the fasteners provided with the outboard. For example, do not mount tow sport bars or boarding ladders onto the boat using the mounting hardware included with the outboard. Installing other products onto the boat that utilize the outboard mounting hardware will compromise the ability of that hardware to properly and safely secure the outboard to the transom.

Outboards that require validated mounting hardware will have the following decal on the transom clamp.



51965

Accessories Mounted to the Transom Clamp Bracket

Mercury Marine has been made aware that certain aftermarket marine accessories, such as emergency boarding ladders, shallow water anchors, transom wedge kits, and tow sport attaching devices, have been mounted to the boat by use of the same fasteners that secure the outboard to the transom or jack plate. Using the same fastener to secure both an accessory and the engine to the boat compromises the ability of the fasteners to maintain the proper clamp load. A boat with loose engine mounting fasteners creates the possibility of performance, durability, and safety issues.

ENGINE INSTALLATION

⚠ WARNING

Avoid serious injury or death resulting from a loss of boat control. Loose engine fasteners could cause the transom bracket to fail, resulting in a loss of the driver's ability to control the boat. Always ensure that the engine fasteners are tightened to the specified torque.

ACCEPTABLE ACCESSORY MOUNTING TO THE TRANSOM CLAMP BRACKET

After the engine is mounted to the transom or jack plate in accordance with the engine installation instructions, it is acceptable to attach an accessory to the boat by use of the unused bolt holes in the transom clamp bracket as shown in Figure 1.

The following list provides additional guidelines for mounting accessories to the transom clamp bracket.

- The accessory fasteners must pass through the boat transom or jack plate.

ENGINE INSTALLATION

- The installation must not create interference issues, as would an accessory mounting plate resting in the radius of the transom clamp bracket. Refer to Figure 1.

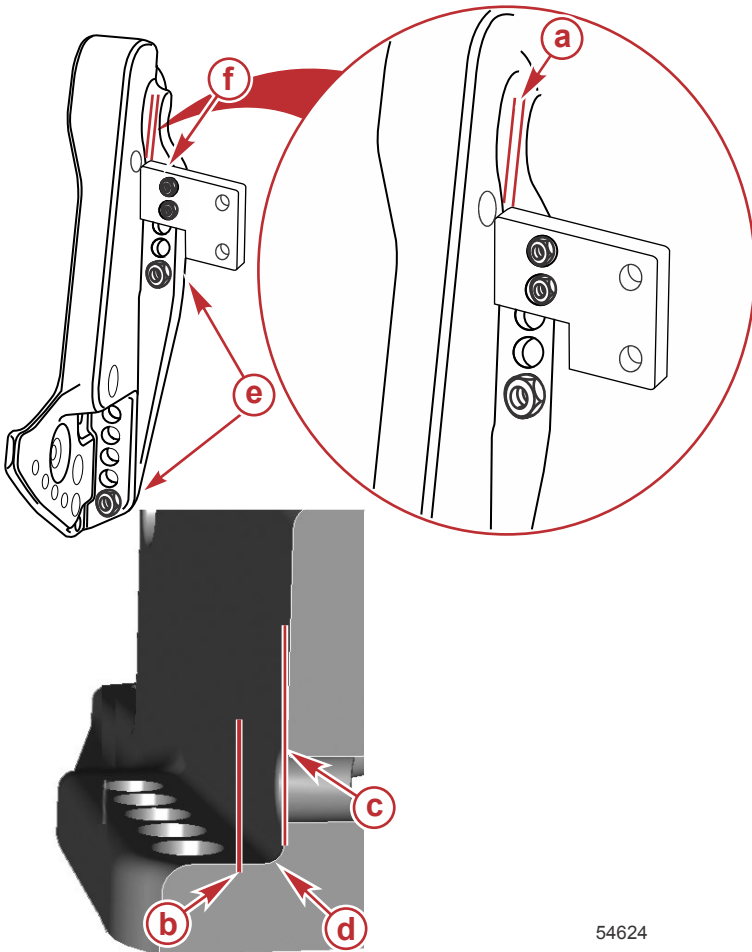

54624

Figure 1

- a** - Minimum clearance 3.175 mm (0.125 in.)
- b** - Edge of accessory bracket
- c** - Transom clamp bracket wall
- d** - Radius
- e** - Engine supplied mounting fasteners
- f** - Fasteners supplied by the accessory manufacturer installed through unused engine mounting bracket holes

ENGINE INSTALLATION

UNACCEPTABLE ACCESSORY MOUNTING

IMPORTANT: Do not use the fasteners that secure the engine to the boat (either the transom or the jack plate) for any purpose other than securing the engine to the boat.

1. Do not mount an accessory to the transom clamp bracket in an unsupported condition. Refer to Figure 2.

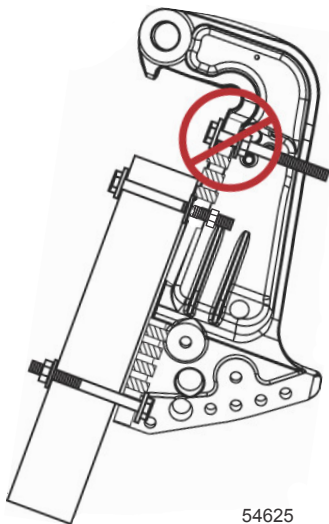

Figure 2

2. Do not attach an accessory to the boat by use of the engine mounting hardware. Refer to Figure 3.

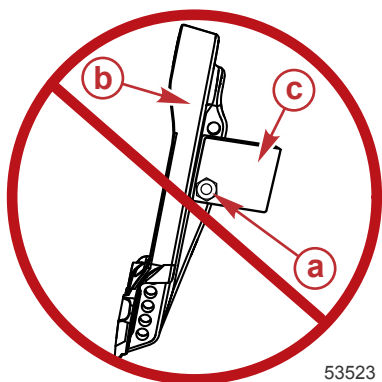

Figure 3

- a** - Engine supplied mounting fasteners
- b** - Transom clamp bracket
- c** - Accessory

ENGINE INSTALLATION

- Do not install wedges or plates between the transom clamp brackets and the transom (or jack plate). Refer to Figure 4.

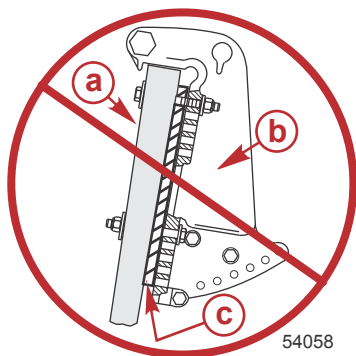

Figure 4

- a**- Boat transom or jack plate
- b**- Transom clamp bracket
- c**- Wedge/plate

Fastening the Outboard to the Transom

MOUNTING BOLTS

Outboard Transom Mounting Hardware - Supplied with Outboard		
Part Number	Part Name	Description
8M0071543	Outboard mounting bolt	½-20 x 5.00 in. long (3.25 in. thread)
826711-17	Nylon insert locknut	½-20
28421	Flat washer	1.50 in. diameter
54012	Flat washer	0.875 in. diameter

Available Outboard Mounting Bolts	
Part Number	Description
67755005	½-20 x 2.50 in. long (1.25 in. thread)
67755006	½-20 x 3.50 in. long (1.25 in. thread)
814259	½-20 x 4.00 in. long (2.25 in. thread)
67755-1	½-20 x 4.50 in. long (2.25 in. thread)
8M0071543	½-20 x 5.00 in. long (3.25 in. thread)
8M0038370	½-20 x 5.50 in. long (3.25 in. thread)
67755-2	½-20 x 6.50 in. long (2.75 in. thread)
8M0028080	½-20 x 7.50 in. long (2.75 in. thread)
8M0032860	½-20 x 8.00 in. long (2.75 in. thread)

ENGINE INSTALLATION

CHECKING BOAT TRANSOM CONSTRUCTION

IMPORTANT: Determine the strength of the boat transom. The outboard mounting locknuts and bolts should be able to hold 75 Nm (55 lb-ft) of torque without the boat transom yielding or cracking. If the boat transom yields or cracks under this torque, the construction of the transom may not be adequate. The boat transom must be strengthened or the load carrying area increased.

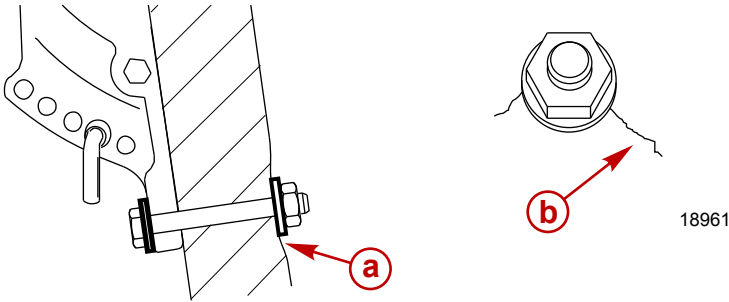

- a** - Transom yielding under bolt torque
- b** - Transom cracking under bolt torque

Use a dial torque wrench to determine transom strength. If the bolt or nut continues to turn without the torque reading on the dial increasing, it is an indication that the transom is yielding. The load area can be increased by using a larger washer or a transom reinforcement plate.

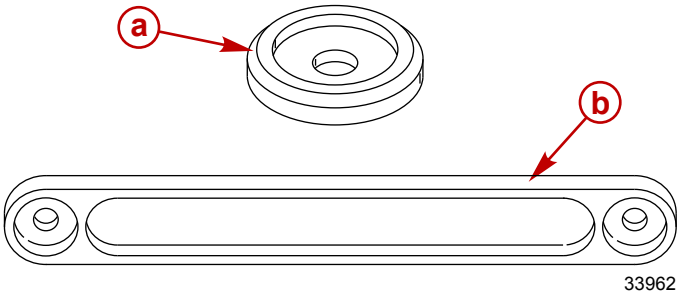

- a** - Large transom washer
- b** - Transom reinforcement plate

ENGINE INSTALLATION

FASTENING THE OUTBOARD TO THE TRANSOM

IMPORTANT: The transom mounting surface must be flat within 3.17 mm (0.125 in.). No step in the transom mounting surface is allowed. The inside transom mounting bolt washer surface must be flat within 3.17 mm (0.125 in.).

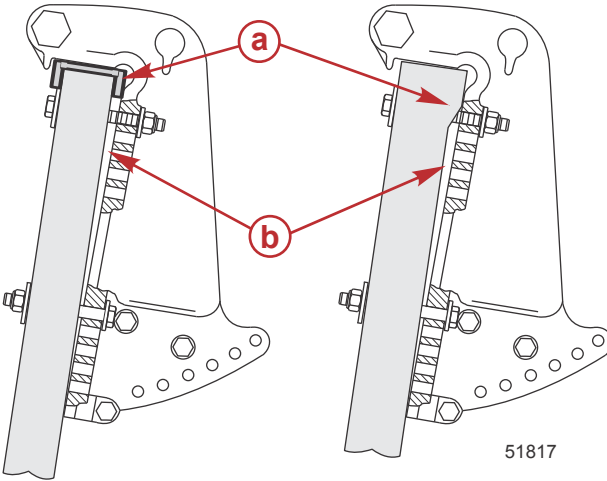

a - Step (not allowed)

b - Gap between transom clamp and boat transom (not allowed)

ENGINE INSTALLATION

IMPORTANT: Clearance must be maintained between the vessel transom and the outboard transom bracket relief radius area. Failure to maintain clearance may damage the transom bracket and cause the transom bracket to fail. Adjustments to the position of the Mercury Marine transom drilling fixture may be required to ensure proper clearance of the transom bracket relief radius area.

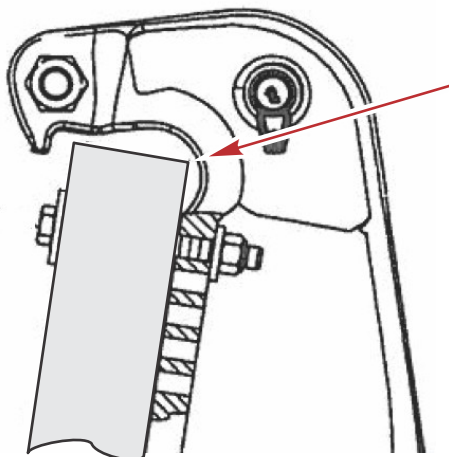

51867

Installation

1. Apply marine sealer to the shanks of the bolts, not to the threads.
2. Fasten the outboard with the correct mounting hardware. Tighten the locknuts to the specified torque.

IMPORTANT: Ensure that a minimum of two full threads of the mounting bolts extend beyond the locknut after tightening. The locknut must be drawn tight while still engaging the bolt threads and not contacting the shank of the bolt.

ENGINE INSTALLATION

NOTE: For a more accurate torque reading, tighten the mounting locknuts rather than the outboard mounting bolts.

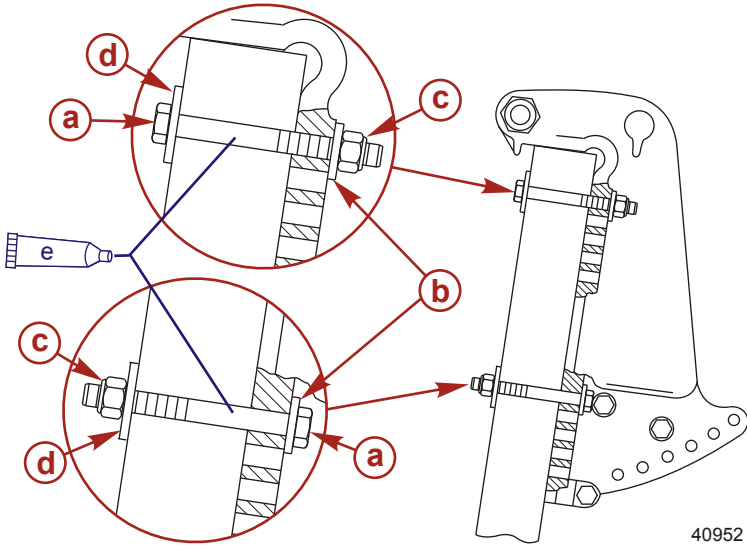

40952

- a** - 0.500 in. diameter outboard mounting bolt (4)
- b** - 0.875 in. flat washer (4)
- c** - Nylon insert locknut (4)
- d** - 1.500 in. flat washer (4)
- e** - Marine sealer – apply to the shank of the bolts, not the threads

Description	Nm	lb-in.	lb-ft
Outboard mounting locknuts and bolts – standard boat transom	75	–	55
Outboard mounting locknuts and bolts – metal lift plates and setback brackets	122	–	90

ENGINE INSTALLATION

A decal on the transom bracket reminds the owner to check the fasteners securing the outboard to the transom before each use.



Decal on the transom bracket

Installing Outboard

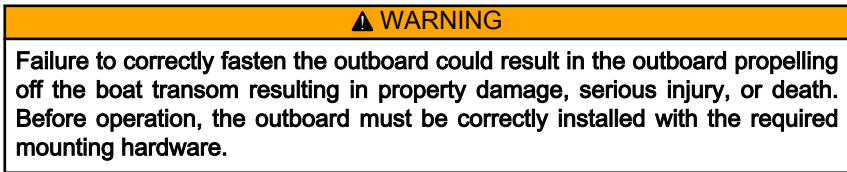

We strongly recommend that your dealer install your outboard and related accessories to ensure proper installation and good performance. If you install the outboard yourself, follow instructions in the outboard installation manual which is provided with the outboard.

ENGINE INSTALLATION

The outboard must be secured to the transom with the four 12.7 mm (1/2 in.) diameter mounting bolts and locknuts provided. Install two bolts through the upper set of holes and two bolts through the lower set of holes.

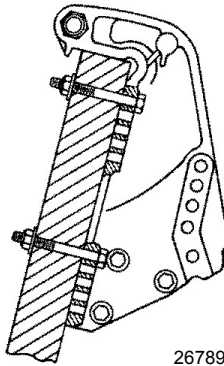

26789

Maximum Outboard Mounting Height

The mounting height of the outboard must not exceed 635 mm (25 in.) for EL models and 762 mm (30 in.) for EXL models. Mounting the outboard higher may cause damage to the gearcase components.

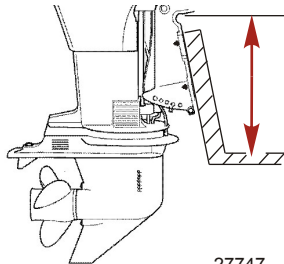

27747

MAINTENANCE LOG

Maintenance Log

Record all maintenance performed on your outboard here. Be sure to save all work orders and receipts.

Date	Maintenance Performed	Engine Hours