



**MERCURY**

8M0114069 1215 eng



**Operation  
Maintenance  
and  
Installation  
Manual**

© 2016 Mercury Marine

**8/9.9 and 9.9 Command Thrust/ProKicker FourStroke**



## Welcome

You have selected one of the finest marine power packages available. It incorporates numerous design features to ensure operating ease and durability.

With proper care and maintenance, you will enjoy using this product for many boating seasons. To ensure maximum performance and carefree use, we ask that you thoroughly read this manual.

The Operation and Maintenance Manual contains specific instructions for using and maintaining your product. We suggest that this manual remain with the product for ready reference whenever you are on the water.

Thank you for purchasing one of our products. We sincerely hope your boating will be pleasant!

Mercury Marine, Fond du Lac, Wisconsin, U.S.A.

### Name / function:

John Pfeifer, President,  
Mercury Marine



## Read This Manual Thoroughly

**IMPORTANT: If you do not understand any portion of this manual, contact your dealer. Your dealer can also provide a demonstration of actual starting and operating procedures.**

## Notice

Throughout this publication, and on your power package, warnings, cautions,

and notices, accompanied by the International Hazard Symbol , may be used to alert the installer and user to special instructions concerning a particular service or operation that may be hazardous if performed incorrectly or carelessly. Observe them carefully.

These safety alerts alone cannot eliminate the hazards that they signal. Strict compliance with these special instructions while performing the service, plus common sense operation, are major accident prevention measures.

### WARNING

Indicates a hazardous situation which, if not avoided, could result in death or serious injury.

### CAUTION

Indicates a hazardous situation which, if not avoided, could result in minor or moderate injury.

## NOTICE

Indicates a situation which, if not avoided, could result in engine or major component failure.

**IMPORTANT:** Identifies information essential to the successful completion of the task.

*NOTE:* Indicates information that helps in the understanding of a particular step or action.

**IMPORTANT:** The operator (driver) is responsible for the correct and safe operation of the boat, the equipment aboard, and the safety of all occupants aboard. We strongly recommend that the operator read this Operation and Maintenance Manual and thoroughly understand the operational instructions for the power package and all related accessories before the boat is used.

## ⚠ WARNING

The engine exhaust from this product contains chemicals known to the state of California to cause cancer, birth defects or other reproductive harm.

The serial numbers are the manufacturer's keys to numerous engineering details that apply to your Mercury Marine power package. When contacting Mercury Marine about service, **always specify model and serial numbers.**

Descriptions and specifications contained herein were in effect at the time this was approved for printing. Mercury Marine, whose policies are based on continuous improvement, reserves the right to discontinue models at any time or to change specifications or designs without notice and without incurring obligation.

## Warranty Message

The product you have purchased comes with a **limited warranty** from Mercury Marine; the terms of the warranty are set forth in the Warranty Manual included with the product. The Warranty Manual contains a description of what is covered, what is not covered, the duration of coverage, how to best obtain warranty coverage, **important disclaimers and limitations of damages**, and other related information. Please review this important information.

## Copyright and Trademark Information

© **MERCURY MARINE. All rights reserved. Reproduction in whole or in part without permission is prohibited.**

Alpha, Axius, Bravo One, Bravo Two, Bravo Three, Circle M with Waves Logo, K-planes, Mariner, MerCathode, MerCruiser, Mercury, Mercury with Waves Logo, Mercury Marine, Mercury Precision Parts, Mercury Propellers, Mercury Racing, MotorGuide, OptiMax, Quicksilver, SeaCore, Skyhook, SmartCraft, Sport-Jet, Verado, VesselView, Zero Effort, Zeus, #1 On the Water and We're Driven to Win are registered trademarks of Brunswick Corporation. Pro XS is a trademark of Brunswick Corporation. Mercury Product Protection is a registered service mark of Brunswick Corporation.



## Identification Records

Please record the following applicable information:

<b>Outboard</b>		
<b>Engine Model and Horsepower</b>		
<b>Engine Serial Number</b>		
<b>Gear Ratio</b>		
<b>Propeller Number</b>	<b>Pitch</b>	<b>Diameter</b>
<b>Hull Identification Number (HIN)</b>		<b>Purchase Date</b>
<b>Boat Manufacturer</b>	<b>Boat Model</b>	<b>Length</b>
<b>Exhaust Gas Emissions Certification Number (Europe Only)</b>		



---

## General Information

---

Boater's Responsibilities.....	1
Before Operating Your Outboard.....	1
Boat Horsepower Capacity.....	1
High-Speed and High-Performance Boat Operation.....	2
Outboard Remote Control Models .....	2
Remote Steering Notice.....	3
Lanyard Stop Switch.....	3
Protecting People in the Water.....	6
Passenger Safety Message - Pontoon Boats and Deck Boats.....	6
Wave and Wake Jumping.....	8
Impact with Underwater Hazards.....	9
Exhaust Emissions.....	10
Selecting Accessories for Your Outboard.....	12
Safe Boating Recommendations.....	12
Recording Serial Number .....	15
8/9.9 FourStroke Specifications .....	15
Component Identification - Standard Models.....	16
Component Identification - Command Thrust/ProKicker Models.....	19

---

## Transporting

---

Carrying, Storing, and Transporting Your Outboard when Removed from Boat .....	20
Trailing Boat/Outboard - Models with Power Tilt.....	21
Trailing Boat/Outboard - Models without Power Tilt.....	21

---

## Fuel and Oil

---

Fuel Requirements.....	23
Low Permeation Fuel Hose Requirement .....	24
EPA Pressurized Portable Fuel Tank Requirements.....	24
Fuel Demand Valve (FDV) Requirement.....	24
Mercury Marine's Pressurized Portable Fuel Tank.....	25
Filling Fuel Tank.....	26
Engine Oil Recommendations.....	26
Checking Engine Oil.....	27

---

## Features and Controls

---

Tiller Handle Features.....	29
Remote Control Features.....	35
Warning System.....	36
Power Tilt (if equipped).....	37
Setting The Transom Angle Of Your Outboard .....	39
Adjusting Transom Angle.....	41
Shallow Water Operation.....	41
Tilting Outboard.....	42
Trim Tab Adjustment.....	43

---

## Operation

---

Prestarting Check List.....	44
Operating in Freezing Temperatures.....	44
Operating in Saltwater or Polluted Water.....	44
Operating Outboard as an Auxiliary Engine.....	45
Prestarting Instructions.....	45
Engine Break-in Procedure.....	46
Starting the Engine - Tiller Handle Models.....	46
Starting the Engine - Remote Control Models.....	49
Starting a Hot Engine.....	51
Gear Shifting .....	51
Stopping the Engine .....	52
Emergency Starting.....	53

---

## Maintenance

---

Outboard Care.....	56
EPA Emission Regulations.....	56
Inspection and Maintenance Schedule.....	57
Flushing the Cooling System.....	58
Top Cowl Removal And Installation.....	60
Battery Inspection .....	61
Exterior Care.....	61
Fuel System.....	61
Steering Link Rod Fasteners.....	62
Corrosion Control Anode .....	64
Propeller Replacement .....	64
Fuse Replacement - Electric Start Models .....	66
Spark Plug Inspection and Replacement.....	67
Timing Belt Inspection.....	68
Changing Engine Oil .....	68
Lubrication Points .....	70
Gearcase Lubrication.....	72
Checking Power Tilt Fluid.....	74
Submerged Outboard.....	75

---

## Storage

---

Storage Preparation.....	76
Protecting External Outboard Components.....	76
Protecting Internal Engine Components.....	77
Gearcase.....	77
Positioning Outboard for Storage.....	77
Battery Storage.....	78

---

## Troubleshooting

---

Starter Motor Will Not Crank the Engine (Electric Start Models) .....	79
Engine Will Not Start.....	79
Engine Runs Erratically.....	79
Performance Loss.....	80
Battery Will Not Hold Charge.....	80

---

## Owner Service Assistance

---

Service Assistance.....	81
Ordering Literature.....	83

---

## Installation

---

Boat Horsepower Capacity.....	85
Start in Gear Protection.....	85
Selecting Accessories for Your Outboard.....	85
Low Permeation Fuel Hose Requirement .....	86
Mercury Marine Validated Engine Mounting Hardware.....	86
Installing Outboard.....	87
Remote Control Installation.....	89
Steering Link Rod Fasteners.....	90
Remote Wire Harness Connection.....	92
Control Cable Installation.....	94
Battery Installation - Electric Start Models.....	98
Battery Connections.....	99
Propeller Installation.....	99

---

## Maintenance Log

---

Maintenance Log.....	101
----------------------	-----

# GENERAL INFORMATION

## Boater's Responsibilities

The operator (driver) is responsible for the correct and safe operation of the boat and the safety of its occupants and general public. It is strongly recommended that each operator read and understand this entire manual before operating the outboard.

Be sure that at least one additional person onboard is instructed in the basics of starting and operating the outboard and boat handling in case the driver is unable to operate the boat.

## Before Operating Your Outboard

Read this manual carefully. Learn how to operate your outboard properly. If you have any questions, contact your dealer.

Safety and operating information that is practiced, along with using good common sense, can help prevent personal injury and product damage.

This manual as well as safety labels posted on the outboard use the following safety alerts to draw your attention to special safety instructions that should be followed.

### WARNING

Indicates a hazardous situation which, if not avoided, could result in death or serious injury.

### CAUTION

Indicates a hazardous situation which, if not avoided, could result in minor or moderate injury.

### NOTICE

Indicates a situation which, if not avoided, could result in engine or major component failure.

## Boat Horsepower Capacity

### WARNING

Exceeding the boat's maximum horsepower rating can cause serious injury or death. Overpowering the boat can affect boat control and flotation characteristics or break the transom. Do not install an engine that exceeds the boat's maximum power rating.

# GENERAL INFORMATION

Do not overpower or overload your boat. Most boats will carry a required capacity plate indicating the maximum acceptable power and load as determined by the manufacturer following certain federal guidelines. If in doubt, contact your dealer or the boat manufacturer.

U.S. COAST GUARD CAPACITY	
MAXIMUM HORSEPOWER	XXX
MAXIMUM PERSON CAPACITY (POUNDS)	XXX
MAXIMUM WEIGHT CAPACITY	XXX

26777

## High-Speed and High-Performance Boat Operation

If your outboard is to be used on a high-speed or high-performance boat with which you are unfamiliar, we recommend that you do not operate it at its high speed capability without first requesting an initial orientation and familiarization demonstration ride with your dealer or an operator experienced with your boat/outboard combination. For additional information, obtain a copy of our **Hi-Performance Boat Operation** booklet from your dealer, distributor, or Mercury Marine.

## Outboard Remote Control Models

The remote control connected to your outboard must be equipped with a start in neutral only protection device. This prevents the engine from starting when the shift is actuated in any position other than neutral.

### ▲ WARNING

**Starting the engine with the drive in gear can cause serious injury or death. Never operate a boat that does not have a neutral-safety-protection device.**

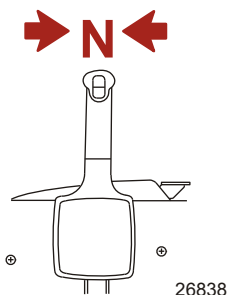



# GENERAL INFORMATION

## Remote Steering Notice

The steering link rod that connects the steering cable to the engine must be fastened utilizing self-locking nuts. These self-locking nuts must never be replaced with common nuts (non-locking) as they will work loose and vibrate off, freeing the link rod to disengage.

### ⚠ WARNING

Improper fasteners or improper installation procedures can result in loosening or disengagement of the steering link rod. This can cause a sudden, unexpected loss of boat control, resulting in serious injury or death due to occupants being thrown within or out of the boat. Always use required components and follow instructions and torque procedures.

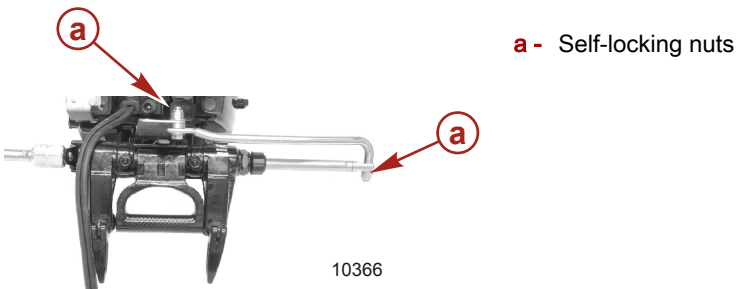

## Lanyard Stop Switch

The purpose of a lanyard stop switch is to turn off the engine when the operator moves far enough away from the operator's position (as in accidental ejection from the operator's position) to activate the switch. Tiller handle outboards and some remote control units are equipped with a lanyard stop switch. A lanyard stop switch can be installed as an accessory - generally on the dashboard or side adjacent to the operator's position.

A decal near the lanyard stop switch is a visual reminder for the operator to attach the lanyard to their personal flotation device (PFD) or wrist.

# GENERAL INFORMATION

The lanyard cord is usually 122–152 cm (4–5 feet) in length when stretched out, with an element on one end made to be inserted into the switch and a clip on the other end for attaching to the operator's PFD or wrist. The lanyard is coiled to make its at-rest condition as short as possible to minimize the likelihood of lanyard entanglement with nearby objects. Its stretched-out length is made to minimize the likelihood of accidental activation should the operator choose to move around in an area close to the normal operator's position. If it is desired to have a shorter lanyard, wrap the lanyard around the operator's wrist or leg, or tie a knot in the lanyard.

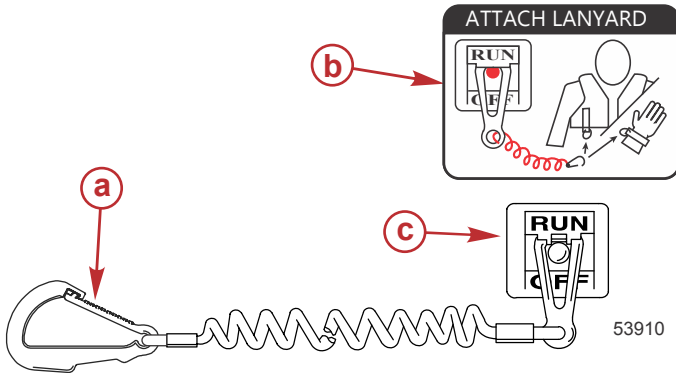

- a - Lanyard cord clip
- b - Lanyard decal
- c - Lanyard stop switch

Read the following Safety Information before proceeding.

**Important Safety Information:** The purpose of a lanyard stop switch is to stop the engine when the operator moves far enough away from the operator's position to activate the switch. This would occur if the operator accidentally falls overboard or moves within the boat a sufficient distance from the operator's position. Falling overboard and accidental ejections are more likely to occur in certain types of boats such as low sided inflatables, bass boats, high performance boats, and light, sensitive handling fishing boats operated by a hand tiller. Falling overboard and accidental ejections are also likely to occur as a result of poor operating practices such as sitting on the back of the seat or gunwale at planing speeds, standing at planing speeds, sitting on elevated fishing boat decks, operating at planing speeds in shallow or obstacle infested waters, releasing your grip on a steering wheel or tiller handle that is pulling in one direction, drinking alcohol or consuming drugs, or daring high speed boat maneuvers.

# GENERAL INFORMATION

While activation of the lanyard stop switch will stop the engine immediately, a boat will continue to coast for some distance depending upon the velocity and degree of any turn at shut down. However, the boat will not complete a full circle. While the boat is coasting, it can cause injury to anyone in the boat's path as seriously as the boat would when under power.

We strongly recommend that other occupants be instructed on proper starting and operating procedures should they be required to operate the engine in an emergency (if the operator is accidentally ejected).

## **⚠ WARNING**

**If the operator falls out of the boat, stop the engine immediately to reduce the possibility of serious injury or death from being struck by the boat. Always properly connect the operator to the stop switch using a lanyard.**

## **⚠ WARNING**

**Avoid serious injury or death from deceleration forces resulting from accidental or unintended stop switch activation. The boat operator should never leave the operator's station without first disconnecting the stop switch lanyard from the operator.**

Accidental or unintended activation of the switch during normal operation is also a possibility. This could cause any, or all, of the following potentially hazardous situations:

- Occupants could be thrown forward due to unexpected loss of forward motion - a particular concern for passengers in the front of the boat who could be ejected over the bow and possibly struck by the gearcase or propeller.
- Loss of power and directional control in heavy seas, strong current, or high winds.
- Loss of control when docking.

## **KEEP THE LANYARD STOP SWITCH AND LANYARD CORD IN GOOD OPERATING CONDITION**

Before each use, check to ensure the lanyard stop switch works properly. Start the engine and stop it by pulling the lanyard cord. If the engine does not stop, have the switch repaired before operating the boat.

Before each use, visually inspect the lanyard cord to ensure it is in good working condition and that there are no breaks, cuts, or wear to the cord. Check that the clips on the ends of the cord are in good condition. Replace any damaged or worn lanyard cords.

# GENERAL INFORMATION

## Protecting People in the Water

### WHILE YOU ARE CRUISING

It is very difficult for a person standing or floating in the water to take quick action to avoid a boat heading in his/her direction, even at slow speed.



Always slow down and exercise extreme caution any time you are boating in an area where there might be people in the water.

Whenever a boat is moving (coasting) and the outboard gear shift is in neutral position, there is sufficient force by the water on the propeller to cause the propeller to rotate. This neutral propeller rotation can cause serious injury.

### WHILE THE BOAT IS STATIONARY

#### **▲ WARNING**

**A spinning propeller, a moving boat, or any solid device attached to the boat can cause serious injury or death to swimmers. Stop the engine immediately whenever anyone in the water is near your boat.**

Shift the outboard into neutral and shut off the engine before allowing people to swim or be in the water near your boat.

## Passenger Safety Message - Pontoon Boats and Deck Boats

Whenever the boat is in motion, observe the location of all passengers. Do not allow any passengers to stand or use seats other than those designated for traveling faster than idle speed. A sudden reduction in boat speed, such as plunging into a large wave or wake, a sudden throttle reduction, or a sharp change of boat direction, could throw them over the front of the boat. Falling over the front of the boat between the two pontoons will position them to be run over by the outboard.

### BOATS HAVING AN OPEN FRONT DECK

No one should ever be on the deck in front of the fence while the boat is in motion. Keep all passengers behind the front fence or enclosure.

# GENERAL INFORMATION

Persons on the front deck could easily be thrown overboard or persons dangling their feet over the front edge could get their legs caught by a wave and pulled into the water.

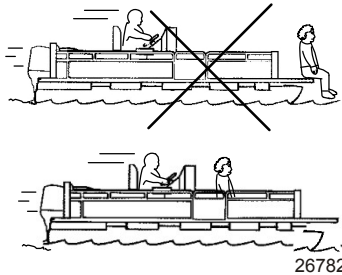

## ⚠ WARNING

**Sitting or standing in an area of the boat not designed for passengers at speeds above idle can cause serious injury or death. Stay back from the front end of deck boats or raised platforms and remain seated while the boat is in motion.**

### BOATS WITH FRONT MOUNTED, RAISED PEDESTAL FISHING SEATS

Elevated fishing seats are not intended for use when the boat is traveling faster than idle or trolling speed. Sit only in seats designated for traveling at faster speeds.

Any unexpected, sudden reduction in boat speed could result in the elevated passenger falling over the front of the boat.

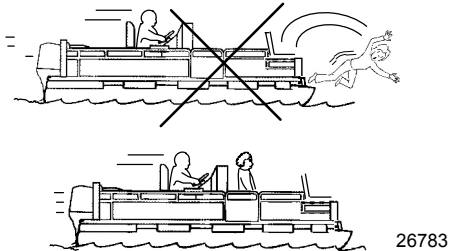

# GENERAL INFORMATION

## Wave and Wake Jumping

Operating recreational boats over waves and wake is a natural part of boating. However, when this activity is done with sufficient speed to force the boat hull partially or completely out of the water, certain hazards arise, particularly when the boat enters the water.

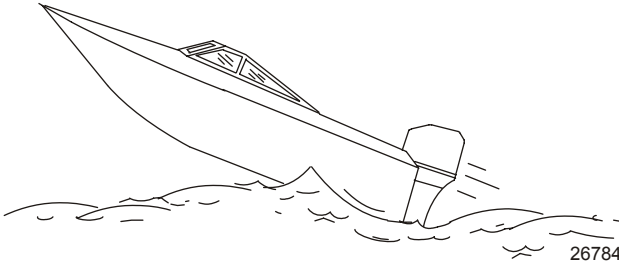

The primary concern is the boat changing direction while in the midst of the jump. In such case, the landing may cause the boat to veer violently in a new direction. Such a sharp change in direction can cause occupants to be thrown out of their seats, or out of the boat.

### **⚠ WARNING**

**Wave or wake jumping can cause serious injury or death from occupants being thrown within or out of the boat. Avoid wave or wake jumping whenever possible.**

There is another less common hazardous result from allowing your boat to launch off a wave or wake. If the bow of your boat pitches down far enough while airborne, upon water contact it may penetrate under the water surface and submarine for an instant. This will bring the boat to a nearly instantaneous stop and can send the occupants flying forward. The boat may also steer sharply to one side.

# GENERAL INFORMATION

## Impact with Underwater Hazards

Reduce speed and proceed with caution whenever you drive a boat in shallow water areas, or in areas where you suspect underwater obstacles may exist which could be struck by the outboard or the boat bottom. **The most important thing you can do to help reduce injury or impact damage from striking a floating or underwater object is to control the boat speed. Under these conditions, boat speed should be kept to a minimum planing speed of 24 to 40 km/h (15 to 25 mph).**

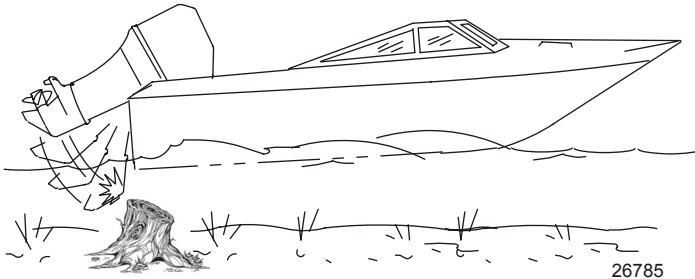

Striking a floating or underwater object could result in an infinite number of situations. Some of these situations could result in the following:

- Part of the outboard or the entire outboard could break loose and fly into the boat.
- The boat could move suddenly in a new direction. Such a sharp change in direction can cause occupants to be thrown out of their seats or out of the boat.
- A rapid reduction in speed. This will cause occupants to be thrown forward, or even out of the boat.
- Impact damage to the outboard and/or boat.

Keep in mind, the most important thing you can do to help reduce injury or impact damage during an impact is control the boat speed. Boat speed should be kept to a minimum planing speed when driving in waters known to have underwater obstacles.

After striking a submerged object, stop the engine as soon as possible and inspect it for any broken or loose parts. If damage is present or suspected, the outboard should be taken to an authorized dealer for a thorough inspection and necessary repair.

The boat should also be checked for any hull fractures, transom fractures, or water leaks.

Operating a damaged outboard could cause additional damage to other parts of the outboard, or could affect control of the boat. If continued running is necessary, do so at greatly reduced speeds.

# GENERAL INFORMATION

## ⚠ WARNING

Operating a boat or engine with impact damage can result in product damage, serious injury, or death. If the vessel experiences any form of impact, have an authorized Mercury Marine dealer inspect and repair the vessel or power package.

## SAFETY INSTRUCTIONS FOR HAND-TILLED OUTBOARDS

No person or cargo should occupy the area directly in front of the outboard while the boat is in motion. If an underwater obstacle is struck, the outboard will tilt up and could seriously injure anyone occupying this area.

### Models with Clamp Screws:

Some outboards come with transom bracket clamp screws. The use of clamp bracket screws alone, is insufficient to properly and safely secure the outboard to the transom. Proper installation of the outboard includes bolting the engine to the boat through the transom. Refer to **Installation - Installing Outboard** for more complete installation information.

## ⚠ WARNING

Failure to correctly fasten the outboard could result in the outboard propelling off the boat transom resulting in property damage, serious injury, or death. Before operation, the outboard must be correctly installed with the required mounting hardware.

If an obstacle is struck at planing speed and the outboard is not securely fastened to the transom, it is possible the outboard could lift off the transom and land in the boat.

## Exhaust Emissions

### BE ALERT TO CARBON MONOXIDE POISONING

Carbon monoxide (CO) is a deadly gas that is present in the exhaust fumes of all internal combustion engines, including the engines that propel boats, and the generators that power boat accessories. By itself, CO is odorless, colorless, and tasteless, but if you can smell or taste engine exhaust, you are inhaling CO.

Early symptoms of carbon monoxide poisoning, which are similar to the symptoms of seasickness and intoxication, include headache, dizziness, drowsiness, and nausea.



# GENERAL INFORMATION

## ⚠ WARNING

Inhaling engine exhaust gases can result in carbon monoxide poisoning, which can lead to unconsciousness, brain damage, or death. Avoid exposure to carbon monoxide.

Stay clear from exhaust areas when engine is running. Keep the boat well-ventilated while at rest or underway.

## STAY CLEAR OF EXHAUST AREAS

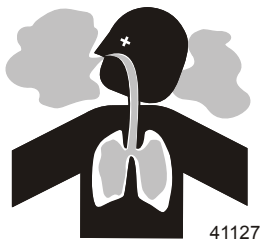

Engine exhaust gases contain harmful carbon monoxide. Avoid areas of concentrated engine exhaust gases. When engines are running, keep swimmers away from the boat, and do not sit, lie, or stand on swim platforms or boarding ladders. While underway, do not allow passengers to be positioned immediately behind the boat (platform dragging, teak/body surfing). This dangerous practice not only places a person in an area of high engine exhaust concentration, but also subjects them to the possibility of injury from the boat propeller.

## GOOD VENTILATION

Ventilate the passenger area, open side curtains or forward hatches to remove fumes.

Example of desired air flow through the boat:

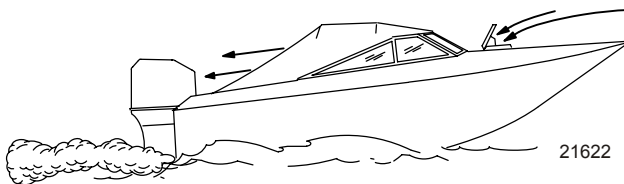

## POOR VENTILATION

Under certain running and/or wind conditions, permanently enclosed or canvas enclosed cabins or cockpits with insufficient ventilation may draw in carbon monoxide. Install one or more carbon monoxide detectors in your boat.

Although the occurrence is rare, on a very calm day, swimmers and passengers in an open area of a stationary boat that contains, or is near, a running engine may be exposed to a hazardous level of carbon monoxide.

# GENERAL INFORMATION

1. Examples of poor ventilation while the boat is stationary:

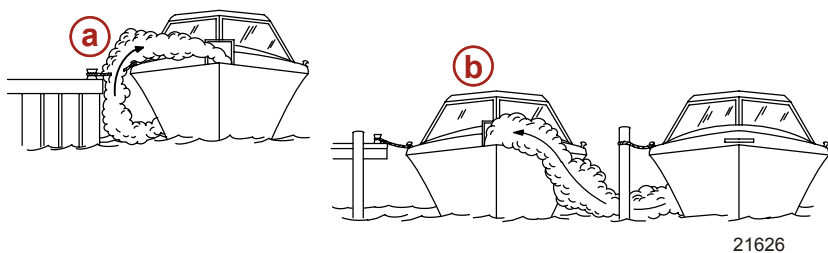

- a - Operating the engine when the boat is moored in a confined space
- b - Mooring close to another boat that has its engine operating

2. Examples of poor ventilation while the boat is moving:

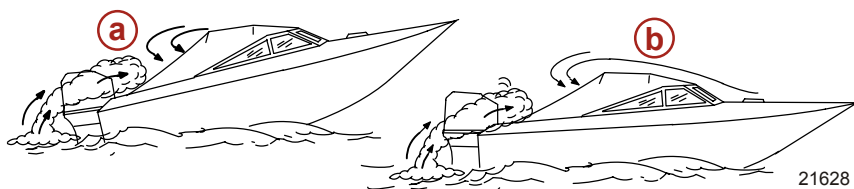

- a - Operating the boat with the trim angle of the bow too high
- b - Operating the boat with no forward hatches open (station wagon effect)

## Selecting Accessories for Your Outboard

Genuine Mercury Precision or Quicksilver Accessories have been specifically designed and tested for your outboard. These accessories are available from Mercury Marine dealers.

**IMPORTANT: Check with your dealer before installing accessories. The misuse of approved accessories or the use of nonapproved accessories can damage the product.**

Some accessories not manufactured or sold by Mercury Marine are not designed to be safely used with your outboard or outboard operating system. Acquire and read the installation, operation and maintenance manuals for all your selected accessories.

## Safe Boating Recommendations

To safely enjoy the waterways, familiarize yourself with local and all other governmental boating regulations and restrictions and consider the following suggestions.

**Know and obey all nautical rules and laws of the waterways.**

# GENERAL INFORMATION

- We recommend that all powerboat operators complete a boating safety course. In the U.S., the U.S. Coast Guard Auxiliary, the Power Squadron, the Red Cross, and your state or provincial boating law enforcement agency provide courses. For more information in the U.S., call the Boat U.S. Foundation at 1-800-336-BOAT (2628).

## **Perform safety checks and required maintenance.**

- Follow a regular schedule and ensure that all repairs are properly made.

## **Check safety equipment onboard.**

- Here are some suggestions of the types of safety equipment to carry when boating:
  - Approved fire extinguishers
  - Signal devices: flashlight, rockets or flares, flag, and whistle or horn
  - Tools necessary for minor repairs
  - Anchor and extra anchor line
  - Manual bilge pump and extra drain plugs
  - Drinking water
  - Radio
  - Paddle or oar
  - Spare propeller, thrust hubs, and an appropriate wrench
  - First aid kit and instructions
  - Waterproof storage containers
  - Spare operating equipment, batteries, bulbs, and fuses
  - Compass and map or chart of the area
  - Personal flotation device (one per person onboard)

## **Watch for signs of weather change and avoid foul weather and rough-sea boating.**

## **Tell someone where you are going and when you expect to return.**

## **Passenger boarding.**

- Stop the engine whenever passengers are boarding, unloading, or are near the back (stern) of the boat. Shifting the drive unit into neutral is not sufficient.

## **Use personal flotation devices.**

- Federal law requires that there be a U.S. Coast Guard-approved life jacket (personal flotation device), correctly sized and readily accessible for every person onboard, plus a throwable cushion or ring. We strongly advise that everyone wear a life jacket at all times while in the boat.

## **Prepare other boat operators.**

# GENERAL INFORMATION

- Instruct at least one person onboard in the basics of starting and operating the engine and boat handling in case the driver becomes disabled or falls overboard.

## **Do not overload your boat.**

- Most boats are rated and certified for maximum load (weight) capacities (refer to your boat's capacity plate). Know your boat's operating and loading limitations. Know if your boat will float if it is full of water. When in doubt, contact your authorized Mercury Marine dealer or the boat manufacturer.

## **Ensure that everyone in the boat is properly seated.**

- Do not allow anyone to sit or ride on any part of the boat that was not intended for such use. This includes the backs of seats, gunwales, transom, bow, decks, raised fishing seats, and any rotating fishing seat. Passengers should not sit or ride anywhere that sudden unexpected acceleration, sudden stopping, unexpected loss of boat control, or sudden boat movement could cause a person to be thrown overboard or into the boat. Ensure that all passengers have a proper seat and are in it before any boat movement.

## **Never operate a boat while under the influence of alcohol or drugs. It is the law.**

- Alcohol or drugs can impair your judgment and greatly reduce your ability to react quickly.

## **Know your boating area and avoid hazardous locations.**

### **Be alert.**

- The operator of the boat is responsible by law to maintain a proper lookout by sight and hearing. The operator must have an unobstructed view particularly to the front. No passengers, load, or fishing seats should block the operator's view when the boat is above idle or planing transition speed. Watch out for others, the water, and your wake.

## **Never drive your boat directly behind a water skier.**

- Your boat traveling at 40 km/h (25 mph) will overtake a fallen skier who is 61 m (200 ft) in front of you in five seconds.

## **Watch fallen skiers.**

- When using your boat for waterskiing or similar activities, always keep a fallen or down skier on the operator's side of the boat while returning to attend to the skier. The operator should always have the down skier in sight and never back up to the skier or anyone in the water.

## **Report accidents.**

# GENERAL INFORMATION

- Boat operators are required by law to file a boating accident report with their state boating law enforcement agency when their boat is involved in certain boating accidents. A boating accident must be reported if 1) there is loss of life or probable loss of life, 2) there is personal injury requiring medical treatment beyond first aid, 3) there is damage to boats or other property where the damage value exceeds \$500.00, or 4) there is complete loss of the boat. Seek further assistance from local law enforcement.

## Recording Serial Number

It is important to record this number for future reference. The serial number is located on the outboard, as shown.

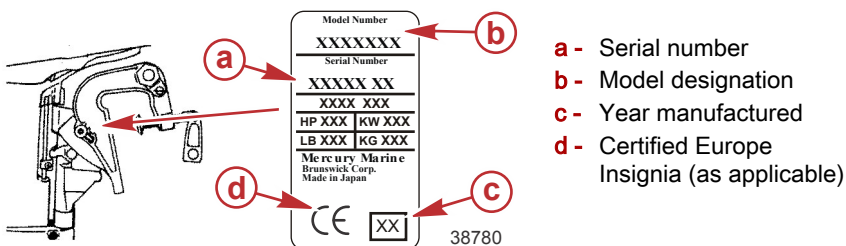

## 8/9.9 FourStroke Specifications

Models	8	9.9	9.9 Command Thrust/ ProKicker
Power	5.88 kw (8 hp)	7.28 kw (9.9 hp)	
Number of cylinders	2		
Full throttle RPM range	5000–6000 RPM		
Idle speed in forward gear	900 RPM		
Piston displacement	209.8 cc (12.8 cid)		
Cylinder bore	55 mm (2.17 in.)		
Piston stroke	44 mm (1.73 in.)		
Valve clearance (cold)			
Intake valve	0.13–0.17 mm (0.0051–0.0067 in.)		
Exhaust valve	0.18–0.22 mm (0.0071–0.0087 in.)		
Recommended spark plug	NGK DCPR6E		
Spark plug gap	0.9 mm (0.035 in.)		
Gear ratio	2.08:1	2.42:1	
Recommended gasoline	Refer to <b>Fuel and Oil</b>		

# GENERAL INFORMATION

Models	8	9.9	9.9 Command Thrust/ ProKicker
Recommended oil	Refer to <b>Fuel and Oil</b>		
Engine oil capacity	800 ml (27.0 fl oz)		
Gearcase lubricant capacity	320 ml (10.8 fl oz)	370 ml (12.5 fl oz)	
Battery rating (electric start models)	465 marine cranking amps (MCA) or 350 cold cranking amps (CCA)		
Emission control system	Engine modification (EM)		
Sound at drivers ear (ICOMIA 39-94) dBA	78.7	79.6	
Tiller handle vibration (ICOMIA 38-94) m/s <sup>2</sup>	<b>Standard Models</b>	<b>9.9 Command Thrust/ ProKicker-PT</b>	
	4.3	6.1	

## Component Identification - Standard Models

### STARBOARD SIDE VIEW

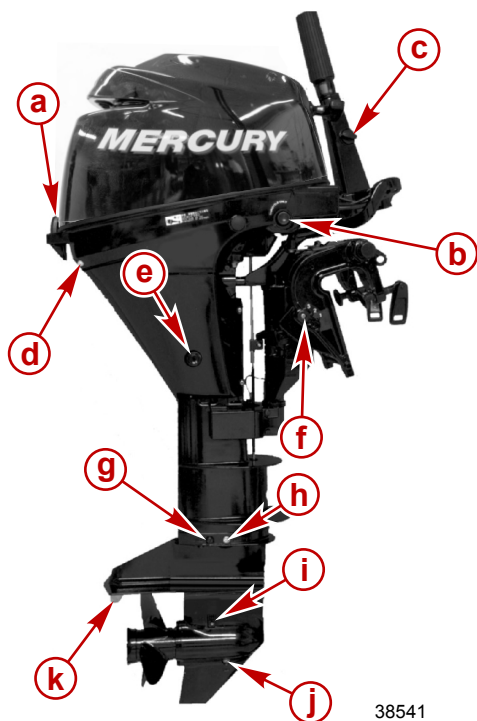

- a** - Cowl latch
- b** - Throttle only button
- c** - Throttle friction adjustment knob
- d** - Water pump indicator hole
- e** - Oil drain plug
- f** - Transom angle preset knob
- g** - Engine flush plug
- h** - Gear lubricant level plug
- i** - Water inlet
- j** - Gear lubricant fill/drain plug
- k** - Trim tab

38541

# GENERAL INFORMATION

## FRONT VIEW

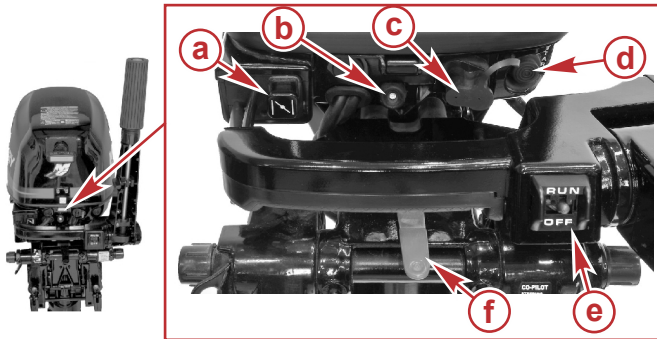

57671

- a** - Choke/fast idle knob
- b** - Oil pressure light
- c** - Fuel line connector
- d** - Start switch (electric tiller handle)
- e** - Lanyard safety switch
- f** - Copilot tension adjustment

# GENERAL INFORMATION

## PORT VIEW

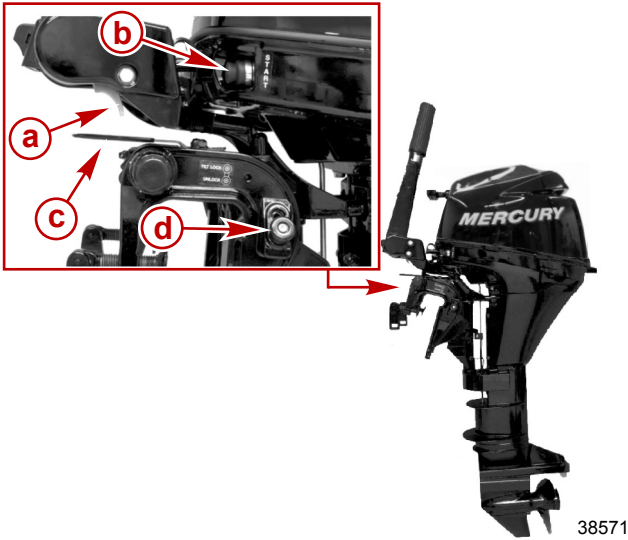

- a** - Tiller lock release lever
- b** - Start switch (electric tiller handle model)
- c** - Steering friction adjustment lever (tiller model only)
- d** - Tilt lock knob



# GENERAL INFORMATION

## Component Identification - Command Thrust/ProKicker Models

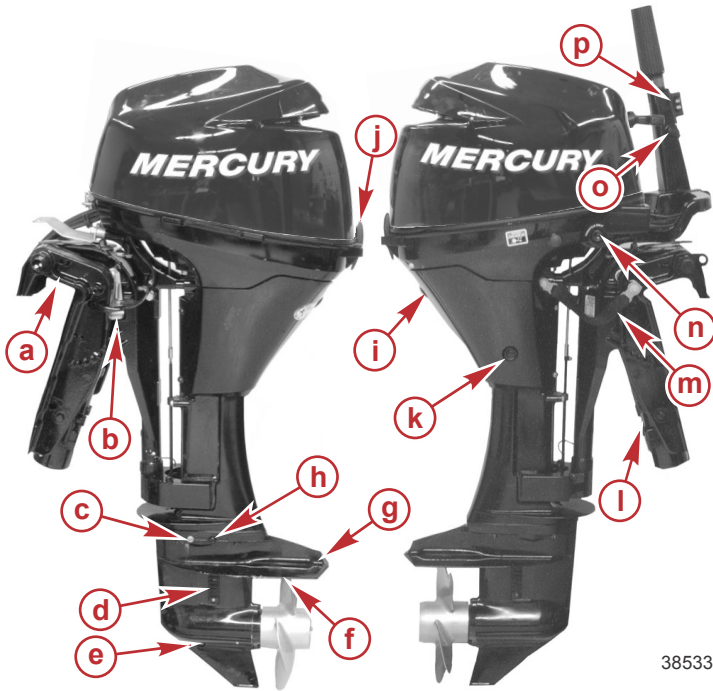

38533

- a** - Transom bracket
- b** - Tilt support lever
- c** - Gear lubricant level plug
- d** - Primary water inlet
- e** - Gear lubricant fill/drain plug
- f** - Secondary water inlet
- g** - Anti-ventilation plate
- h** - Engine flush plug
- i** - Water pump indicator hole
- j** - Cowl latch
- k** - Oil drain screw
- l** - Power tilt
- m** - Kicker strap
- n** - Throttle only button
- o** - Throttle grip friction knob
- p** - Power tilt button

# TRANSPORTING

## Carrying, Storing, and Transporting Your Outboard when Removed from Boat

**IMPORTANT:** Ensure the proper procedures are followed for transportation and storage of the outboard to avoid the possibility of oil leaks.

1. With the outboard still in the water, disconnect the remote fuel line and run engine until it stops. This will drain fuel from the carburetor. Install the protector cap over the fuel connector.

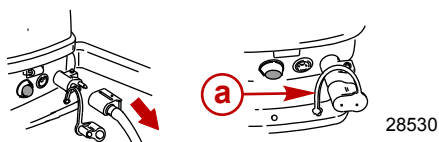

**a** - Protector cap

2. Remove outboard and hold it upright until the water is drained out. Keep the outboard in an upright position when carrying.

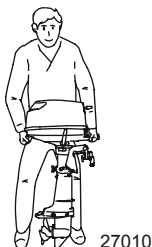

3. Carry, transport, or store the outboard in any of the three positions shown. These positions will prevent oil from draining out of the crankcase.

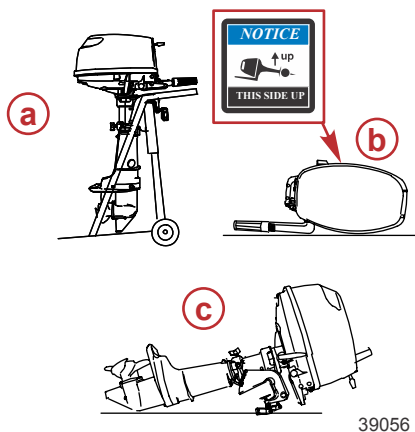

- a** - Upright position
- b** - Tiller handle down
- c** - Front side down

# TRANSPORTING

4. Never carry, store, or transport the outboard in the two positions shown. Engine damage could result from oil draining out of the crankcase.

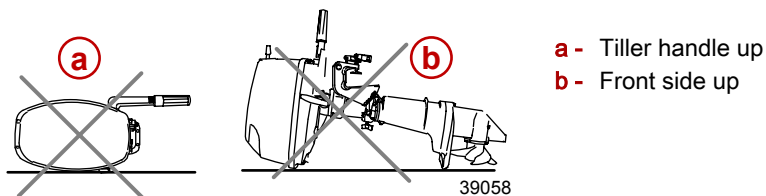

## Trailing Boat/Outboard - Models with Power Tilt

Trailer your boat with the outboard tilted down in a vertical operating position.

If additional ground clearance is required, the outboard should be tilted up using an accessory outboard support device. Refer to your local dealer for recommendations. Additional clearance may be required for railroad crossings, driveways and trailer bouncing.

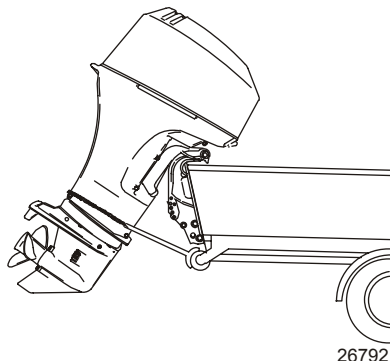

**IMPORTANT: Do not rely on the power tilt system or tilt support lever to maintain proper ground clearance for trailing. The outboard tilt support lever is not intended to support the outboard for trailing.**

Shift the outboard to forward gear. This prevents the propeller from spinning freely.

## Trailing Boat/Outboard - Models without Power Tilt

Trailer your boat with the outboard tilted down in a vertical operating position.

If additional ground clearance is required, the outboard should be tilted up using the shallow water drive/trailing bracket. Additional clearance may be required for railroad crossings, driveways, and trailer bouncing.

**IMPORTANT: The tilt lock lever should be used to lock the outboard down when trailing. This will prevent the outboard from bouncing and causing possible damage to the outboard.**

# TRANSPORTING

Shift the outboard to forward gear. This prevents the propeller from spinning freely.

# FUEL AND OIL

## Fuel Requirements

**IMPORTANT:** Use of improper gasoline can damage your engine. Engine damage resulting from the use of improper gasoline is considered misuse of the engine and will not be covered under the limited warranty.

### FUEL RATINGS

Mercury outboard engines will operate satisfactorily with any major brand of unleaded gasoline that meets the following specifications:

**USA and Canada** - A posted pump octane rating of 87 (R+M)/2, minimum, for most models. Premium gasoline 91 (R+M)/2 octane is also acceptable for most models. **Do not** use leaded gasoline.

**Outside USA and Canada** - A posted pump octane rating of 91 RON, minimum, for most models. Premium gasoline (95 RON) is also acceptable for all models. **Do not** use leaded gasoline.

### USING REFORMULATED (OXYGENATED) GASOLINE (USA ONLY)

Reformulated gasoline is required in certain areas of the USA and is acceptable for use in your Mercury Marine engine. The only oxygenate currently in use in the USA is alcohol (ethanol, methanol, or butanol).

### GASOLINE CONTAINING ALCOHOL

#### Bu16 Butanol Fuel Blends

Fuel blends of up to 16.1% butanol (Bu16) that meet the published Mercury Marine fuel rating requirements are an acceptable substitute for unleaded gasoline. Contact your boat manufacturer for specific recommendations on your boat's fuel system components (fuel tanks, fuel lines, and fittings).

#### Methanol and Ethanol Fuel Blends

**IMPORTANT:** The fuel system components on your Mercury Marine engine will withstand up to 10% alcohol (methanol or ethanol) content in the gasoline. Your boat's fuel system may not be capable of withstanding the same percentage of alcohol. Contact your boat manufacturer for specific recommendations on your boat's fuel system components (fuel tanks, fuel lines, and fittings).

Be aware that gasoline containing methanol or ethanol may cause increased:

- Corrosion of metal parts
- Deterioration of rubber or plastic parts
- Fuel permeation through the rubber fuel lines
- Likelihood of phase separation (water and alcohol separating from the gasoline in the fuel tank)

# FUEL AND OIL

## WARNING

Fuel leakage is a fire or explosion hazard, which can cause serious injury or death. Periodically inspect all fuel system components for leaks, softening, hardening, swelling, or corrosion, particularly after storage. Any sign of leakage or deterioration requires replacement before further engine operation.

**IMPORTANT:** If you use gasoline that contains or might contain methanol or ethanol, you must increase the frequency of inspection for leaks and abnormalities.

**IMPORTANT:** When operating a Mercury Marine engine on gasoline containing methanol or ethanol, do not store the gasoline in the fuel tank for long periods. Cars normally consume these blended fuels before they can absorb enough moisture to cause trouble; boats often sit idle long enough for phase separation to take place. Internal corrosion may occur during storage if alcohol has washed protective oil films from internal components.

## Low Permeation Fuel Hose Requirement

Required for outboards manufactured for sale, sold, or offered for sale in the United States.

- The Environmental Protection Agency (EPA) requires that any outboard manufactured after January 1, 2009, must use low permeation fuel hose for the primary fuel hose connecting the fuel tank to the outboard.
- Low permeation hose is USCG Type B1-15 or Type A1-15, defined as not exceeding 15 g/m<sup>2</sup>/24 h with CE 10 fuel at 23 °C as specified in SAE J 1527 - marine fuel hose.

## EPA Pressurized Portable Fuel Tank Requirements

The Environmental Protection Agency (EPA) requires portable fuel systems that are produced after January 1, 2011, for use with outboard engines to remain fully sealed (pressurized) up to 34.4 kPa (5.0 psi). These tanks may contain the following:

- An air inlet that opens to allow air to enter as the fuel is drawn out of the tank.
- An air outlet that opens (vents) to the atmosphere if pressure exceeds 34.4 kPa (5.0 psi).

## Fuel Demand Valve (FDV) Requirement

Whenever a pressurized fuel tank is used, a fuel demand valve is required to be installed in the fuel hose between the fuel tank and primer bulb. The fuel demand valve prevents pressurized fuel from entering the engine and causing a fuel system overflow or possible fuel spillage.

# FUEL AND OIL

The fuel demand valve has a manual release. The manual release can be used (pushed in) to open (bypass) the valve in case of a fuel blockage in the valve.

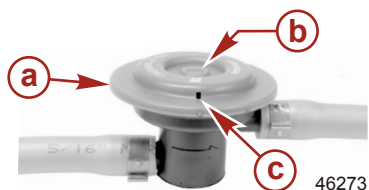

- a** - Fuel demand valve - installed in the fuel hose between the fuel tank and primer bulb
- b** - Manual release
- c** - Vent/water drain holes

## Mercury Marine's Pressurized Portable Fuel Tank

Mercury Marine has created a new portable pressurized fuel tank that meets the preceding EPA requirements. These fuel tanks are available as an accessory or are provided with certain portable outboard models.

### SPECIAL FEATURES OF THE PORTABLE FUEL TANK

- The fuel tank has a two-way valve which allows air to enter the tank as the fuel is drawn to the engine, and also opens to vent to the atmosphere if internal pressure in the tank exceeds 34.4 kPa (5.0 psi). A hissing noise may be heard as the tank vents to the atmosphere. This is normal.
- The fuel tank includes a fuel demand valve that prevents pressurized fuel from entering the engine and causing a fuel system overflow or possible fuel spillage.
- When installing the fuel tank cap, turn the cap to the right until you hear a click. This signals that the fuel cap is fully seated. A built-in device prevents overtightening.
- The fuel tank has a manual vent screw which should be closed for transportation and open for operation and cap removal.

Since sealed fuel tanks are not vented, they will expand and contract as the fuel expands and contracts during heating and cooling cycles of the outside air. This is normal.

### REMOVING THE FUEL CAP

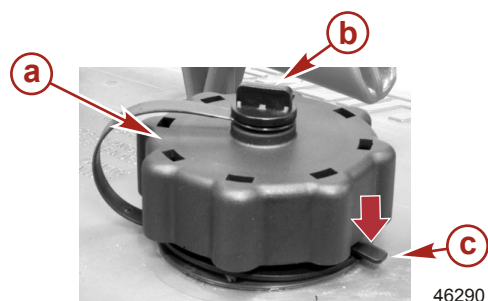

- a** - Fuel cap
- b** - Manual vent screw
- c** - Tab lock

**IMPORTANT:** Contents may be under pressure. Rotate the fuel cap 1/4 turn to relieve pressure before opening.

# FUEL AND OIL

1. Open the manual vent screw on top of the fuel cap.
2. Turn the fuel cap until it contacts the tab lock.
3. Press down on the tab lock. Rotate the fuel cap 1/4 turn to relieve the pressure.
4. Press down on the tab lock again and remove the cap.

## DIRECTIONS FOR USING THE PRESSURIZED PORTABLE FUEL TANK

1. When installing the fuel tank cap, turn the cap to the right until you hear a click. This signals that the fuel cap is fully seated. A built-in device prevents overtightening.
2. Open the manual vent screw on top of the cap for operation and cap removal. Close the manual vent screw for transportation.
3. For fuel hoses that have quick disconnects, disconnect the fuel line from the engine or fuel tank when not in use.
4. Follow **Filling Fuel Tank** instructions for fueling.

## Filling Fuel Tank

### WARNING

**Avoid serious injury or death from a gasoline fire or explosion. Use caution when filling fuel tanks. Always stop the engine and do not smoke or allow open flames or sparks in the area while filling fuel tanks.**

Fill the fuel tanks outdoors away from heat, sparks, and open flames.

Remove the portable fuel tanks from the boat to fill them.

Always stop the engine before filling the tanks.

Do not completely fill the fuel tanks. Leave approximately 10% of the tank volume unfilled. Fuel will expand in volume as its temperature rises and can leak under pressure if the tank is completely filled.

## PORTABLE FUEL TANK PLACEMENT IN THE BOAT

Place the fuel tank in the boat so the vent is higher than the fuel level under normal boat operating conditions.

## Engine Oil Recommendations

Mercury or Quicksilver NMMA FC-W certified SAE 10W-30 4-Stroke Marine Engine Oil is recommended for general, all-temperature use. If NMMA certified synthetic blend oil is preferred, use Mercury or Quicksilver SAE 25W-40 Synthetic Blend Marine 4-Stroke Engine Oil. If the recommended Mercury or Quicksilver NMMA FC-W certified outboard oils are not available, a major FC-W certified 4-stroke outboard oil may be used.



# FUEL AND OIL

**IMPORTANT:** The use of nondetergent oils, multi-viscosity oils (other than Mercury or Quicksilver NMMA FC-W certified oil or a major brand NMMA FC-W certified oil), synthetic oils, low quality or oils that contain solid additives are not recommended.

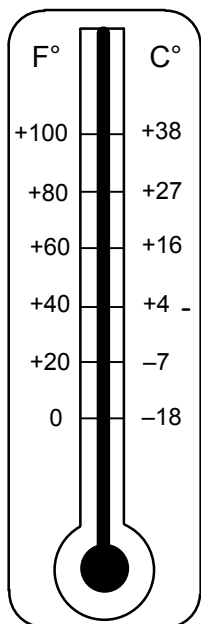

26795

## Recommended SAE viscosity for engine oil

- a -** Mercury or Quicksilver SAE 25W-40 Synthetic Blend Marine 4-Stroke Engine Oil may be used at temperatures above 4 °C (40 °F)
- b -** Mercury or Quicksilver SAE 10W-30 4-Stroke Marine Engine Oil is recommended for use in all temperatures

## Checking Engine Oil

**IMPORTANT:** Do not overfill. Be sure that the outboard is upright (not tilted) when checking oil.

1. Turn the engine off. Have the outboard in a level operating position. Remove the top cowl.
2. Remove the dipstick. Wipe the dipstick with a clean rag or towel and push it back in all the way.
3. Pull the dipstick out again and observe the oil level. If oil level is low, remove the oil filler cap and fill to (but not over) the full mark with the recommended oil.

**IMPORTANT:** Inspect oil for signs of contamination. Oil contaminated with water will have a milky color to it; oil contaminated with fuel will have a strong fuel smell. If contaminated oil is noticed, have the engine checked by your dealer.

# FUEL AND OIL

4. Install the oil filler cap and tighten securely.

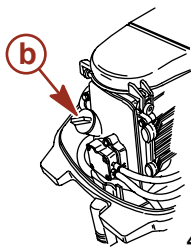
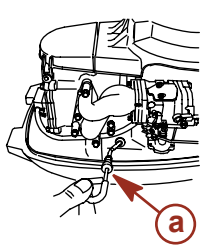

- a** - Dipstick
- b** - Oil filler cap

4914

# FEATURES AND CONTROLS

## Tiller Handle Features

**IMPORTANT:** Avoid engine flooding - Do not rotate the throttle grip while engine is not running. Doing so will inject fuel into the engine and cause a possible hard starting flooded condition.

- A decal on the tiller handle is a quick reference guide for starting a cold or hot engine.



- Tiller handle - Handle can be tilted 180° for convenient handling during transportation and storage.

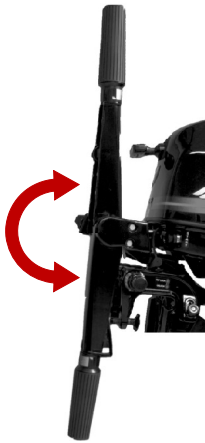

28535

# FEATURES AND CONTROLS

- Tiller lock release lever - Push the lever to move tiller handle from one position to another.

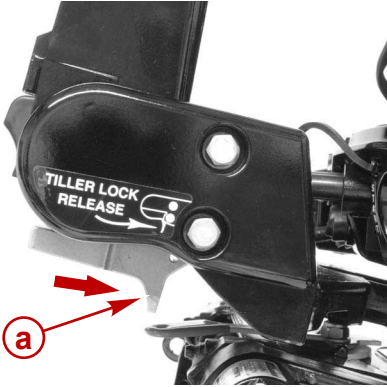

**a** - Tiller lock release lever

3274

- Tiller handle lock cap - Remove the lock cap on top of the tiller handle to lock in the up position. Push the tiller lock release lever to release the handle from the locked up position.

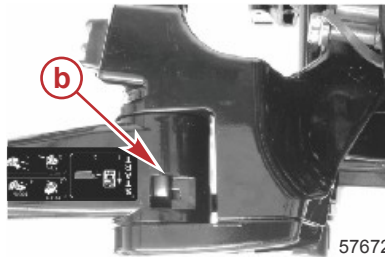
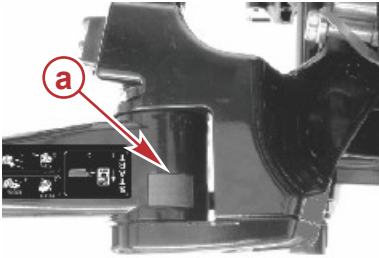

57672

- a** - Lock cap
- b** - Locking mechanism

- Starter rope - Pulling the starter rope cranks the engine over for starting.



28536

# FEATURES AND CONTROLS

- Lanyard stop switch - Refer to **General Information - Lanyard Stop Switch**.

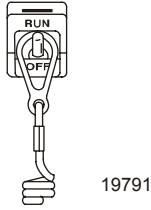

- Engine stop switch - Push in to stop the engine.

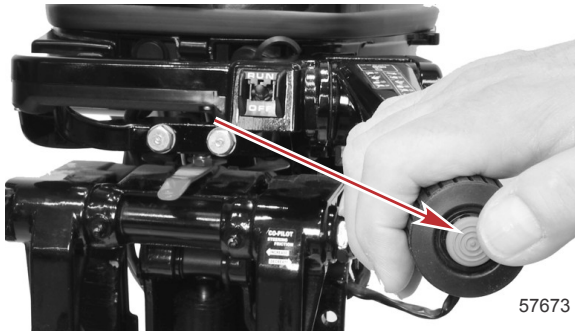

- Power tilt switch - Push to tilt engine up/down.



- Throttle grip friction knob - Turn the friction knob to set and maintain the throttle at desired speed. Turn the knob clockwise to tighten friction or turn the knob counterclockwise to loosen friction.

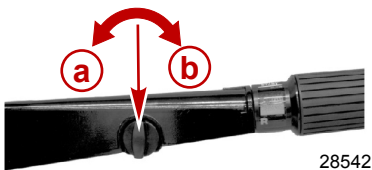

- a** - Loosen friction (counterclockwise)
- b** - Tighten friction (clockwise)

# FEATURES AND CONTROLS

- Throttle only button - Pressing the button in while the outboard is in neutral disables the gear shift control of the tiller handle.



28550

- Throttle grip - Controls the engine speed and shifting.

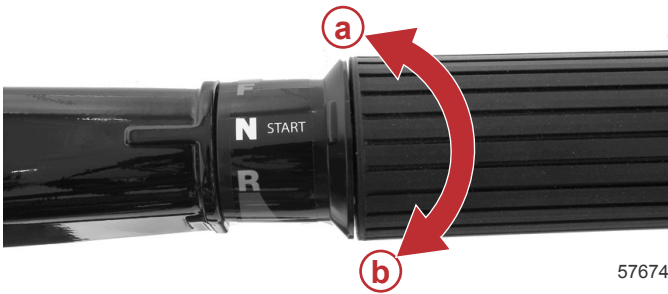

57674

- a** - Reverse gear throttle
- b** - Forward gear throttle

- Choke - Pull out when starting a cold engine.

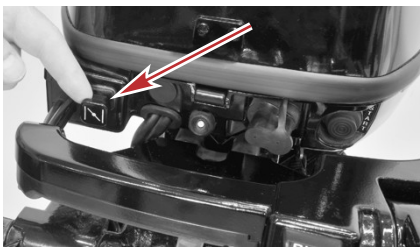

57675

# FEATURES AND CONTROLS

- Low oil pressure warning light - Warns the operator the engine has low oil pressure. When the low oil pressure light is on or is blinking, the engine will run rough and will not exceed 3000 RPM.

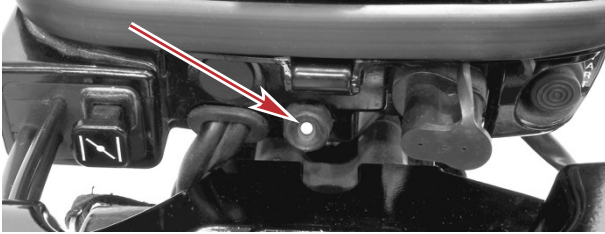

57676

- Electric start button (electric start models) - Press the button to start the engine.



28532

## ⚠ WARNING

Insufficient friction adjustment can cause serious injury or death due to loss of boat control. When setting the friction adjustment, maintain sufficient steering friction to prevent the outboard from steering into a full turn if the tiller handle or steering wheel is released.

- Steering friction adjustment - Adjust this lever to achieve the desired steering friction (drag) on the tiller handle. Move the lever to the left to tighten, or move the lever to the right to loosen.

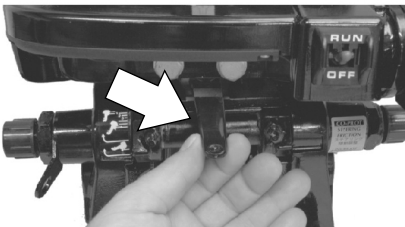

**a** - Tighten

**b** - Loosen



39175

# FEATURES AND CONTROLS

- Tilt lock knob - Locks the engine in the full tilt position.

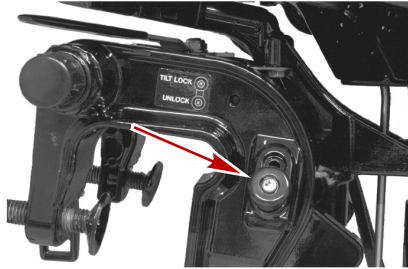

28564

- Trim position knob - Presets the trim position.

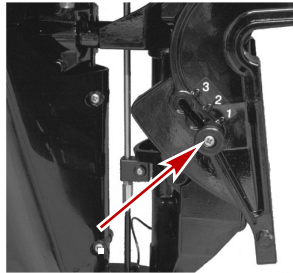

28551

- Kicker strap (power tilt models) - Prevents the engine from turning while tilted up.

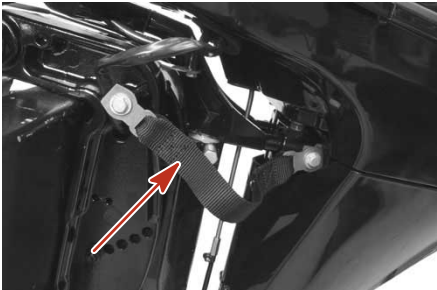

4676



# FEATURES AND CONTROLS

## Remote Control Features

Your boat may be equipped with one of the Mercury Precision or Quicksilver remote controls shown. If not, consult your dealer for a description of the functions and operations of the remote control.



- a** - Trim/tilt switch
- b** - Ignition key switch—OFF, ON, START
- c** - Throttle only button
- d** - Lanyard stop switch

- **Trim/tilt switch** - Used to trim the drive during operation or raise the drive for trailering, launching, beaching, or shallow water operation.
- **Throttle only button** - The throttle only button allows throttle advancement without shifting the engine. The throttle only button disengages the shifting mechanism from the control handle. The throttle only button can be pressed and held in only when the remote control handle is in the neutral position. While holding the throttle only button in, move the throttle handle forward to assist in starting the engine.
- **Lanyard stop switch (if equipped)** - The purpose of a lanyard stop switch is to shut down the engine when the operator moves far enough away from the operator's position to activate the switch. A lanyard stop switch can be installed as an accessory, generally on the dashboard or side adjacent to the operator's position.
- **Control handle** - Operation of the shift and throttle is controlled by the movement of the control handle. Push the control handle forward from neutral with a quick firm motion to the first detent for forward gear. Continue pushing forward to increase speed. Pull the control handle back from neutral with a quick firm motion to the first detent for reverse gear. Continue pulling back to increase speed.

**IMPORTANT: Forcing the shift mechanism while the engine is not operating can result in product damage.**

# FEATURES AND CONTROLS

## GEAR SHIFTING

**IMPORTANT: Observe the following:**

- **Never shift the drive into gear unless the engine speed is at idle.**
- **Do not shift the drive into reverse when the engine is not running.**
- Your power package has three gear shift positions to provide operation: forward (F), neutral (N), and reverse (R).
- When shifting, always stop at the neutral position and allow the engine speed to return to idle.
- Always shift into gear with a quick motion.
- After shifting into gear, advance the lever further to increase speed.



## Warning System

The warning system on this engine does not have a warning horn. Instead, there is an oil pressure light located on the front of the engine. If oil pressure drops below 25 kPa (3.6 psi) the oil pressure light will illuminate, the Engine Guardian System will be activated, and engine RPM will be limited to 3000.

The Engine Guardian System will also limit RPM of the engine in the event of an overspeed condition due to cavitation, no load on propeller, and/or under propped.

# FEATURES AND CONTROLS

## Power Tilt (if equipped)

This outboard has a tilt control called power tilt. This enables the operator to easily adjust the position of the outboard by pressing the tilt switch. With the engine turned off, the outboard can be tilted out of the water. At low idle speed, the outboard can also be tilted up to permit shallow water operation.

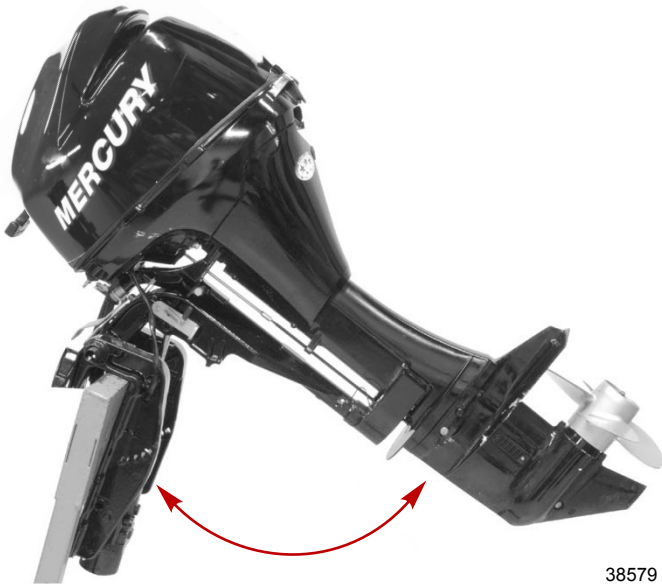

38579

# FEATURES AND CONTROLS

## TILTING OPERATION

To tilt the outboard, shut off the engine and press the tilt switch to the up position. The outboard will tilt up until the switch is released or it reaches its maximum tilt position. Tiller handle models have a kicker strap located on each side of the outboard, preventing the outboard from turning when tilted up.

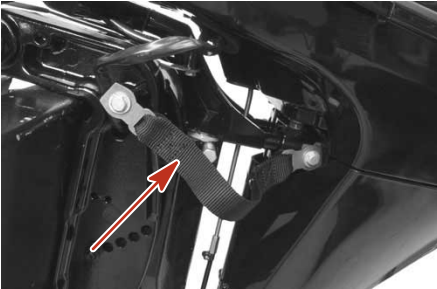

4676



38581

1. Engage the tilt support lever by rotating lever down.
2. Lower the outboard to rest on the tilt support lever.

## FEATURES AND CONTROLS

3. Disengage the tilt support lever by raising the outboard off the support lever and lifting the knob. Lower the outboard.

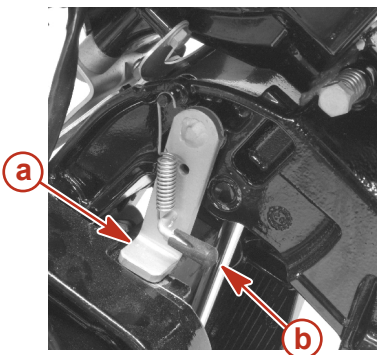

- a - Tilt support lever
- b - Knob

### Setting The Transom Angle Of Your Outboard

The vertical transom angle of your outboard is adjusted by changing the position of the preset tilt knob in one of the three adjustment holes provided. Proper adjustment allows the boat to achieve optimum performance, stability, and minimize steering effort.

**NOTE:** Refer to the following lists when adjusting the transom angle of your outboard.

The preset tilt knob should be adjusted so the outboard is positioned to run perpendicular to the water when the boat is running at full speed. This allows the boat to be driven parallel to the water.

# FEATURES AND CONTROLS

Arrange passengers and load in the boat so the weight is distributed evenly.

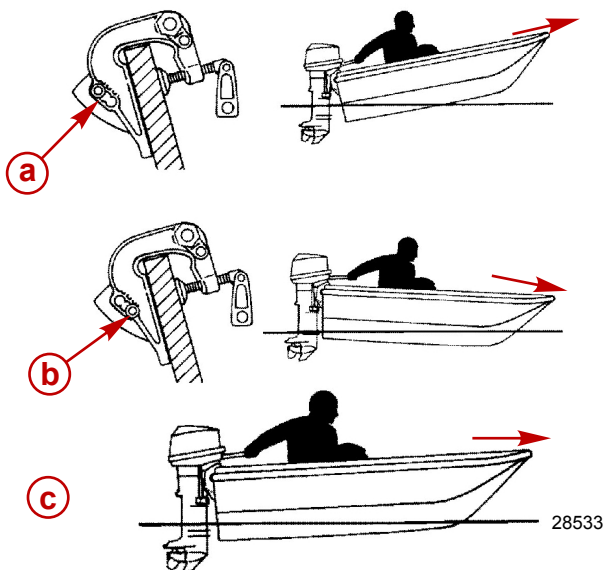

- a** - Too much angle (stern down - bow up)
- b** - Not enough angle (stern up - bow down)
- c** - Angle adjusted properly (bow slightly up)

Consider the following lists carefully when adjusting the operating angle of your outboard.

Adjusting the outboard close to the boat transom can:

- Lower the bow.
- Result in quicker planing off, especially with a heavy load or a stern heavy boat.
- Generally improve the ride in choppy water.
- Increase steering torque or pull to the right.
- In excess can lower the bow of some boats to a point where they begin to plow with their bow in the water while on plane. This can result in an unexpected turn in either direction (called bow steering or over-steering) if any turn is attempted or if a significant wave is encountered.

Adjusting the outboard away from the boat transom can:

- Lift the bow out of the water.
- Generally increase top speed.
- Increase clearance over submerged objects or a shallow bottom.
- Increase steering torque or pull to the left at a normal installation height.

# FEATURES AND CONTROLS

- In excess can cause boat porpoising (bouncing) or propeller ventilation.

## Adjusting Transom Angle

1. Stop the engine. Shift the outboard into forward. Raise the engine to one of the tilt release positions. Change the preset knob position and lower the outboard to the preset transom angle position.
2. Repeat step number one if the transom angle needs further adjustment.

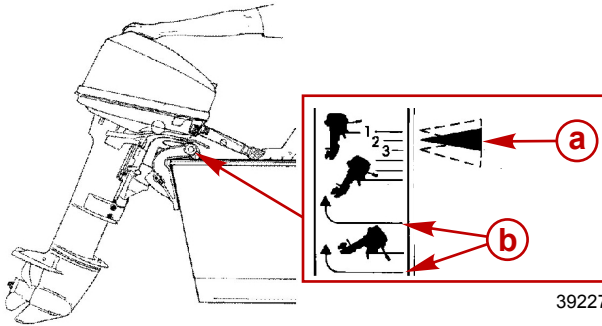

- a** - Transom angle settings
- b** - Tilt release position

## Shallow Water Operation

There are three (3) shallow water drive positions that enable the outboard to be tilted up to prevent hitting the bottom.

1. Stop the engine. Shift the outboard into neutral. Tilt the outboard up to one of the shallow water drive positions. Ensure the water intake is submerged.

# FEATURES AND CONTROLS

- To release the shallow water drive, stop the engine and tilt the outboard up to one of the tilt release position. Gently lower the outboard to the preset transom angle.

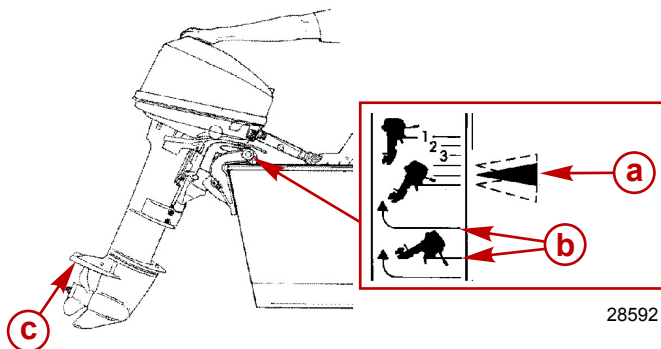

28592

- a** - Shallow water drive positions
- b** - Tilt release positions
- c** - Water Intake

## Tilting Outboard

- Stop the engine. Shift the outboard into the forward gear position.
- Take hold of the top cowl grip and raise the outboard to the full up position.
- Pull out on the tilt lock knob and move it to the lock position. The outboard cannot be lowered while the tilt lock knob is in the lock position.
- To lower the engine, move the tilt lock knob to the unlock position.
- Raise the outboard to the tilt release position and gently lower the outboard to the preset trim position.

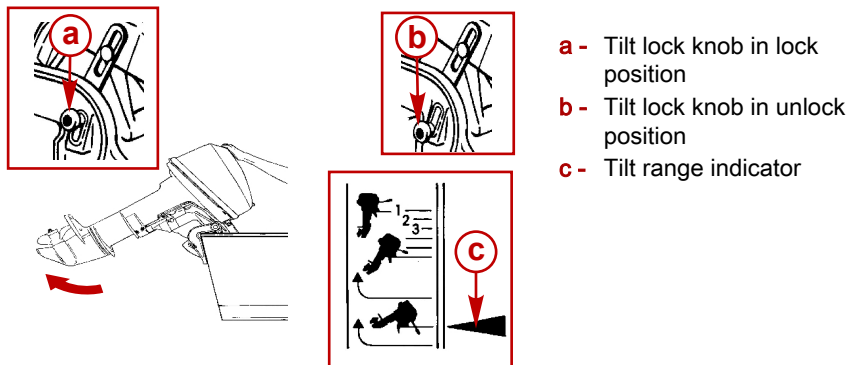

28587



# FEATURES AND CONTROLS

## Trim Tab Adjustment

Propeller steering torque will cause your boat to pull in one direction. This steering torque is a normal thing that results from your outboard not being trimmed so the propeller shaft is parallel to the water surface. The trim tab can help compensate for this steering torque in many cases and can be adjusted within limits to reduce any unequal steering effort.

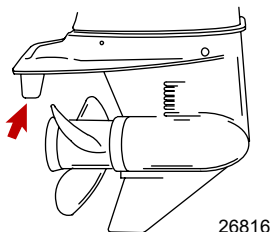

**NOTE:** Trim tab adjustment will have little effect reducing steering torque if the outboard is installed with the anti-ventilation plate approximately 50 mm (2 inches) or more above the boat bottom.

Operate your boat at normal cruising speed, trimmed to the desired position. Turn your boat left and right and note the direction the boat turns more easily.

If adjustment is necessary, loosen trim tab bolt and make small adjustments at a time. If the boat turns more easily to the left, move the trailing edge of trim tab to the left. If the boat turns more easily to the right, move the trailing edge of trim tab to the right. Tighten bolt and retest.

# OPERATION

## Prestarting Check List

- Operator knows safe navigation, boating, and operating procedures.
- An approved personal flotation device of suitable size for each person aboard and readily accessible (it is the law).
- A ring type life buoy or buoyant cushion designed to be thrown to a person in the water.
- Know your boats' maximum load capacity. Look at the boat capacity plate.
- Fuel supply OK.
- Arrange passengers and load in the boat so the weight is distributed evenly and everyone is seated in a proper seat.
- Tell someone where you are going and when you expect to return.
- It is illegal to operate a boat while under the influence of alcohol or drugs.
- Know the waters and area you will be boating; tides, currents, sand bars, rocks, and other hazards.
- Make inspection checks listed in **Maintenance - Inspection and Maintenance Schedule**.

## Operating in Freezing Temperatures

When using your outboard or having your outboard moored in freezing or near freezing temperatures, keep the outboard tilted down at all times so the gearcase is submerged. This prevents the trapped water in the gearcase from freezing and causing possible damage to the water pump and other components.

If there is a chance of ice forming on the water, the outboard should be removed and drained completely of water. If ice should form at the water level inside the outboard driveshaft housing, it will block water flow to the engine causing possible damage.

## Operating in Saltwater or Polluted Water

We recommend that you flush the internal water passages of your outboard with fresh water after each use in salt or polluted water. This will prevent a buildup of deposits from clogging the water passages. Refer to **Maintenance - Flushing the Cooling System**.

If you keep your boat moored in the water, always tilt the outboard so the gearcase is completely out of water (except in freezing temperatures) when not in use.

Wash the outboard exterior and flush out the exhaust outlet of the propeller and gearcase with fresh water after each use. Each month, spray Mercury Precision or Quicksilver Corrosion Guard on external metal surfaces. Do not spray on corrosion control anodes as this will reduce the effectiveness of the anodes.

# OPERATION

## Operating Outboard as an Auxiliary Engine

If the outboard is used as an auxiliary engine, stop the engine and tilt the outboard out of the water when using the main power source.

**IMPORTANT:** The outboard must be restrained from bouncing while operating the boat using the main power source. Bouncing can damage the outboard and boat transom.

## Prestarting Instructions

1. Connect the remote fuel line to the outboard. Make sure connector is snapped into place.

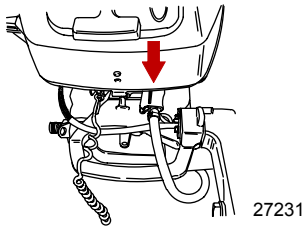

2. Check the engine oil level.

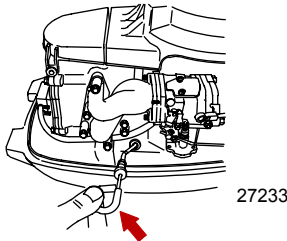

### NOTICE

Without sufficient cooling water, the engine, the water pump, and other components will overheat and suffer damage. Provide a sufficient supply of water to the water inlets during operation.

3. Make sure the cooling water intake is submerged.

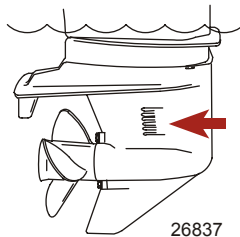

# OPERATION

## Engine Break-in Procedure

**IMPORTANT:** Failure to follow the engine break-in procedures can result in poor performance throughout the life of the engine and can cause engine damage. Always follow break-in procedures.

1. For the first hour of operation, run the engine at varied throttle settings up to 2000 RPM or at approximately half throttle.
2. For the second hour of operation, run the engine at varied throttle settings up to 3000 RPM or at three-quarter throttle, and at full throttle for approximately one minute every ten minutes.
3. For the next eight hours of operation, avoid continuous operation at full throttle for more than five minutes at a time.

## Starting the Engine - Tiller Handle Models

Before starting, read the **Prestarting Check List**, special operating instructions, and **Engine Break-in Procedure**.

1. Open the fuel tank vent on the manual venting type tanks.

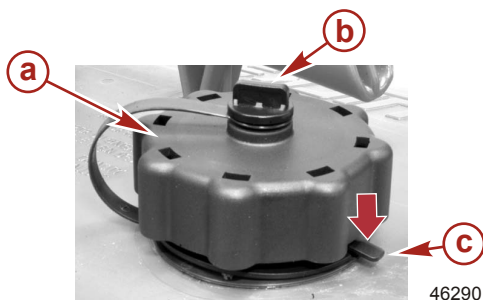

- a - Fuel cap
- b - Manual vent screw
- c - Tab lock

2. Position the fuel line primer bulb so the arrow on the side of the bulb is pointing up. Squeeze the fuel line primer bulb several times until it feels firm.

**IMPORTANT:** To prevent engine flooding, do not squeeze the primer bulb after the engine has warmed up.

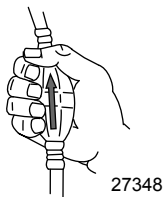

# OPERATION

3. Set the lanyard stop switch to RUN position. Refer to **General Information—Lanyard Stop Switch**.

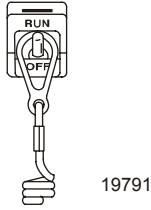

4. Set the tiller handle gear shift to the neutral start position.



## 5. Cold engine -

- Pull the choke knob out two detent positions for starting a cold engine. The choke is closed in this position.
- After the engine is running, push the choke knob in one detent. The choke is partially open in this position.
- After the engine starts to warm up, push the choke knob in. The choke is open in this position.

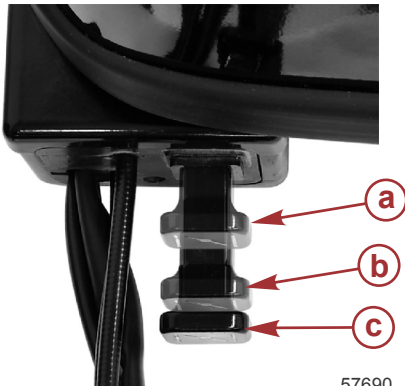

- a** - Choke is open
- b** - Choke is partially open
- c** - Choke is closed

**IMPORTANT:** Outboards with battery charging capabilities must not be operated with battery cables disconnected from the battery. Damage to the charging system may result.

# OPERATION

6. **Manual starting models** - Pull the starter rope slowly until you feel the starter engage, then pull rapidly to crank the engine. Allow rope to return slowly. Repeat until the engine starts. After the engine has started, push in the choke knob.

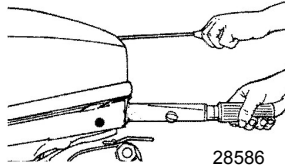

7. **Electric start tiller handle models** - Push the starter button and crank the engine. Release the button when the engine starts. Do not operate the starter motor continuously for longer than ten seconds at a time. If the engine fails to start, wait 30 seconds and try again.
8. **Flooded engine** - If the engine will not start, push in the throttle only button and advance the throttle grip to fast throttle speed. Push the choke knob all the way in and try to start the engine. After the engine has started, immediately reduce throttle speed to idle.



9. Check for a steady stream of water flowing out of the water pump indicator hole.

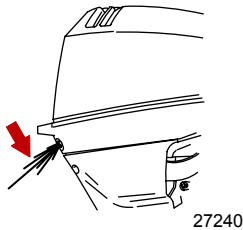

# OPERATION

**IMPORTANT:** If no water is coming out of the water pump indicator hole, stop the engine and check the cooling water intake for obstruction. No obstruction may indicate a water pump failure or blockage in the cooling system. These conditions will cause the engine to overheat. Have the outboard checked by your dealer. Operating the engine while overheated will cause serious engine damage.

## WARMING UP ENGINE

Before beginning operation, allow the engine to warm up at idling speed for three minutes.

## Starting the Engine - Remote Control Models

Before starting, read the **Prestarting Check List**, special operating instructions, and **Engine Break-in Procedure**.

1. Open the fuel tank vent on the manual venting type tanks.

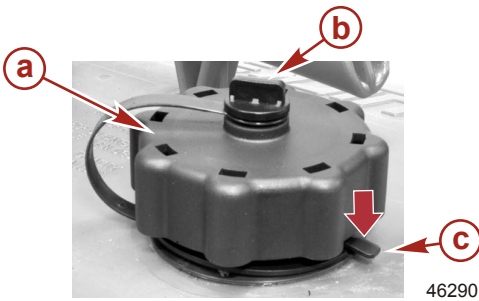

- a - Fuel cap
- b - Manual vent screw
- c - Tab lock

2. Position the fuel line primer bulb so the arrow on the side of the bulb is pointing up. Squeeze the fuel line primer bulb several times until it feels firm.

**IMPORTANT:** To prevent engine flooding, do not squeeze the primer bulb after the engine has warmed up.

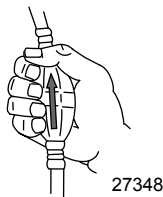

# OPERATION

3. Set the lanyard stop switch to RUN position. Refer to **General Information—Lanyard Stop Switch**.



19791

4. Ensure the remote control handle is in the neutral position.  
**IMPORTANT: Avoid engine flooding - Do not advance the throttle when the engine is not running. This will inject fuel into the engine and may cause a hard starting flooded condition.**

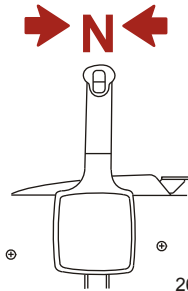

26838

**IMPORTANT: Outboards with battery charging capabilities must not be operated with the battery cables disconnected from the battery. Damage to the charging system may result.**

5. Do not use the throttle only feature on the remote control for initial starting. After starting the engine, you can slowly advance the throttle only lever, or press the throttle only button and advance the control handle to increase idle speed until the engine is warmed up. Keep the engine speed below 2000 RPM.

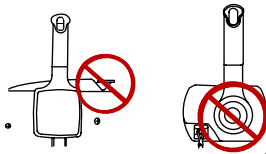

27242

**NOTE: Starting flooded engine - lift the neutral fast idle lever to full up and continue to crank the engine for starting.**



# OPERATION

6. Turn the ignition key to the START position. If the engine is cold, push the key in to choke the engine while cranking. If the engine fails to start in ten seconds, wait 30 seconds and try again. If the engine begins to stall, push the key in (choke) until the engine is running smoothly.

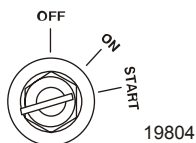

7. Check for a steady stream of water flowing out of the water pump indicator hole.

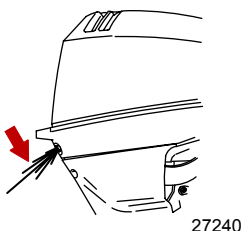

**IMPORTANT:** If no water is coming out of the water pump indicator hole, stop the engine and check the cooling water intake for obstruction. No obstruction may indicate a water pump failure or blockage in the cooling system. These conditions will cause the engine to overheat. Have the outboard checked by your dealer. Operating the engine while overheated will cause engine damage.

## WARMING UP ENGINE

Before beginning operation, allow the engine to warm up at idling speed for three minutes.

## Starting a Hot Engine

### TILLER HANDLE MODELS

1. Pull the choke knob out one detent. The choke is partially open.
2. Crank the engine with the recoil rope or with the electric start button.
3. Push the choke knob in after the engine has started.

### REMOTE CONTROL MODELS

1. Crank the engine over while pushing the key in to engage the choke solenoid.
2. After the engine has started, release the key.

## Gear Shifting

**IMPORTANT:** Never shift outboard into gear unless engine speed is at idle. Do not shift outboard into reverse when the engine is not running.

# OPERATION

- Your outboard has three gear shift positions to provide operation: forward (F), neutral (N), and reverse (R).
- **Tiller handle models** - Reduce the engine speed to idle before shifting.



- a** - (R) reverse
- b** - (N) neutral
- c** - (F) forward

- **Remote control models** - When shifting, always stop at the neutral position and allow the engine speed to return to idle.

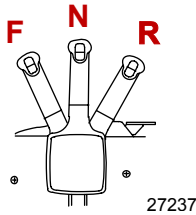

- Always shift the outboard into gear with a quick motion.
- After shifting the outboard into gear, advance the remote control lever or rotate the throttle grip (tiller handle) to increase speed.

## Stopping the Engine

1. **Remote control models** - Reduce the engine speed and shift the outboard to neutral position. Turn the ignition key to "OFF" position.

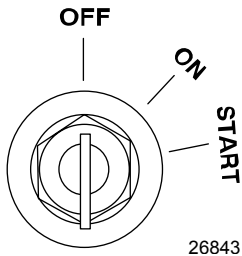

# OPERATION

2. **Tiller handle models** - Reduce the engine speed and shift the outboard to neutral position. Push in the engine stop button or turn the ignition key to "OFF" position.

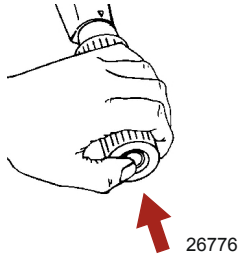

## Emergency Starting

If the starter system fails, use the spare starter rope (provided) and follow this procedure.

### **▲ WARNING**

**The neutral-speed-protection device is inoperative when starting the engine with the emergency starter rope. Set the engine speed at idle and the gear shift in neutral to prevent the outboard from starting in gear.**

1. Shift the outboard into neutral.
2. Ensure the lanyard stop switch is in the run position.
3. Remove the top cowl.

# OPERATION

- Remove the three screws holding the flywheel cover on.

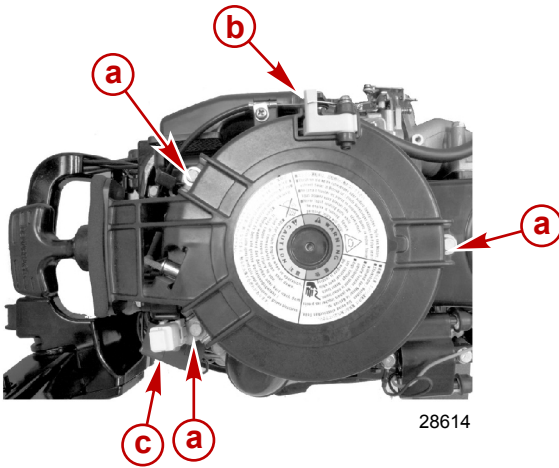

- a** - Flywheel cover screws (3)
- b** - Recoil neutral interlock
- c** - Fuse holder

- Remove the flywheel cover.
- Remote Control models - Ensure the key switch is in the "ON" position.

## ▲ WARNING

High voltage is present any time the key is turned on, especially when starting or operating the engine. Do not touch ignition components or metal test probes and stay clear of spark plug leads when performing live tests.

## ▲ WARNING

The exposed moving flywheel can cause serious injury. Keep your hands, hair, clothing, tools, and other objects away from engine when starting or running the engine. Do not attempt to reinstall the flywheel cover or top cowl when engine is running.

- Refer to the appropriate starting procedure (cold or hot).

# OPERATION

8. Place the starter rope knot into the flywheel notch and wind the rope clockwise around the flywheel.

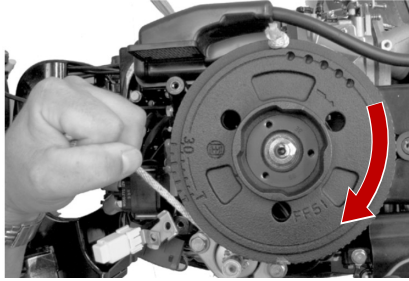

28616

9. Pull the starter rope quickly.

# MAINTENANCE

## Outboard Care

To keep your outboard in the best operating condition, it is important that your outboard receive the periodic inspections and maintenance listed in the **Inspection and Maintenance Schedule**. We urge you to keep it maintained properly to ensure the safety of you and your passengers, and retain its dependability.

Record maintenance performed in the **Maintenance Log** at the back of this book. Save all maintenance work orders and receipts.

## SELECTING REPLACEMENT PARTS FOR YOUR OUTBOARD

We recommend using original Mercury Precision or Quicksilver replacement parts and Genuine Lubricants.

## EPA Emission Regulations

All new outboards manufactured by Mercury Marine are certified to the United States Environmental Protection Agency, as conforming to the requirements of the regulations for the control of air pollution from new outboard motors. This certification is contingent on certain adjustments set to factory standards. For this reason, the factory procedure for servicing the product must be strictly followed and, wherever practicable, returned to the original intent of the design.

**Maintenance, replacement, or repair of the emission control devices and systems may be performed by any marine spark ignition (SI) engine repair establishment or individual.**

# MAINTENANCE

## EMISSION CERTIFICATION LABEL

An emission certification label, showing emission levels and engine specifications directly related to emissions, is placed on the engine at time of manufacture.

The diagram shows a rectangular label with a black header and footer. The header contains the text "EMISSION CONTROL INFORMATION" in white. Below the header, the label is divided into several sections. At the top, it says "THIS ENGINE CONFORMS TO [ ] CALIFORNIA AND U.S. EPA EMISSION REGULATIONS FOR SPARK IGNITION MARINE ENGINES. REFER TO OWNER'S MANUAL FOR REQUIRED MAINTENANCE SPECIFICATIONS AND ADJUSTMENTS. PLEASE PERFORM THE ENGINE MAINTENANCE CORRECTLY." Below this, there are several rows of fields with arrows pointing to them from callouts a-h:

- a** points to the "DISPLACEMENT" field.
- b** points to the "FEL: HC+NOx=" field.
- c** points to the "LOW-PERM/HIGH-PERM=" field.
- d** points to the "TIMING" field.
- e** points to the "FAMILY:" field.
- f** points to the "HP:" field.
- g** points to the "MAXIMUM POWER:" field.
- h** points to the "IDLE SPEED (IN GEAR):" field.

The label also features a calendar on the left and right sides, with months from JAN to DEC. The footer contains the text "MERCURY MARINE" and the number "43058".

- a** - Piston displacement
- b** - Maximum emission output for the engine family
- c** - Percent of fuel line permeation
- d** - Timing specification
- e** - Family number
- f** - Engine family description
- g** - Engine power - kilowatts
- h** - Idle speed

## OWNER RESPONSIBILITY

The owner/operator is required to have routine engine maintenance performed to maintain emission levels within prescribed certification standards.

The owner/operator is not to modify the engine in any manner that would alter the horsepower or allow emission levels to exceed their predetermined factory specifications.

## Inspection and Maintenance Schedule

### DAILY CHECKS

- Check the engine oil level
- Check the lanyard stop switch
- Inspect the fuel system for leaks
- Inspect the engine tightness on the transom
- Check the steering system for binding
- Check the propeller for damage
- Inspect the hydraulic steering fittings and hoses for leaks or signs of damage, if equipped

# MAINTENANCE

- Check the hydraulic steering fluid level, if equipped

## AFTER EACH USE

- Wash the power package exterior with fresh water
- Flush the outboard cooling system, saltwater or brackish water only

## ANNUALLY OR 100 HOURS

- Grease the engine, if applicable
- Change the engine oil and filter, if equipped
- Inspect the thermostat, saltwater or brackish water only
- Add Quickleen to the fuel tank, once per year, per engine
- Apply anti-seize to the spark plug threads
- Replace the gear lubricant
- Inspect the corrosion control anodes
- Replace all filters on the suction side of the fuel system—dealer item
- Lubricate the driveshaft splines—dealer item
- Lubricate the propeller shaft splines—dealer item
- Check the tightness on all the fasteners—dealer item
- Check the torque of the outboard mounting hardware—dealer item
- Check the battery condition and tightness of the battery cable connection—dealer item

## THREE YEARS OR 300 HOURS

- Replace the spark plugs
- Replace the water pump impeller—dealer item
- Inspect the carbon fiber reeds—dealer item
- Inspect the wire harness connectors—dealer item
- Check the remote control cable adjustment, if applicable—dealer item
- Replace the high-pressure fuel filter—dealer item
- Replace the accessory drive belt—dealer item
- Check the power trim fluid level—dealer item
- Inspect the engine motor mounts—dealer item

## Flushing the Cooling System

Flush the internal water passages of the outboard with fresh water after each use in salt, polluted, or muddy water. This will help prevent a buildup of deposits from clogging the internal water passages.

Use a Mercury Precision or Quicksilver accessory (or equivalent) flushing attachment.

**IMPORTANT:** The engine must be run during flushing in order to open the thermostat and circulate water through the water passages.





# MAINTENANCE

## ⚠ WARNING

Rotating propellers can cause serious injury or death. Never operate the boat out of the water with a propeller installed. Before installing or removing a propeller, place the drive unit in neutral and engage the lanyard stop switch to prevent the engine from starting. Place a block of wood between the propeller blade and the anti-ventilation plate.

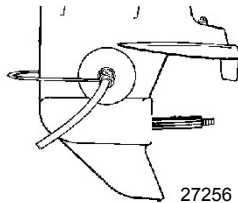
1. Remove the propeller. Refer to **Propeller Replacement**. Install the flushing attachment so the rubber cups fit tightly over the cooling water intake.



Flushing Device	91-44357Q 2
 <p>9192</p>	<p>Attaches to the water intakes; provides a fresh water connection when flushing the cooling system or operating the engine.</p>

2. Attach a water hose to the flushing attachment. Turn on the water and adjust the flow so water is leaking around the rubber cups to ensure the engine receives an adequate supply of cooling water.

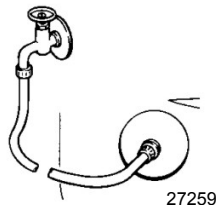

3. Start the engine and run it at idle speed in neutral shift position.  
**IMPORTANT: Do not run the engine above idle when flushing.**

# MAINTENANCE

4. Adjust the water flow (if necessary) so excess water continues leaking out from around the rubber cups to ensure the engine is receiving an adequate supply of cooling water.

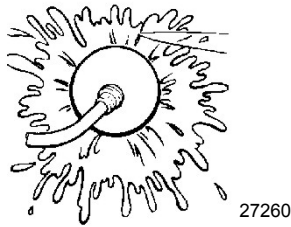

5. Check for a steady stream of water flowing out of the water pump indicator hole. Continue flushing the outboard for 3 to 5 minutes, carefully monitoring water supply at all times.
6. Stop the engine, turn off the water, and remove the flushing attachment. Install the propeller.

## Top Cowl Removal And Installation

### REMOVAL

1. Pull out the front cowl latch.



2. Lift front of cowl to clear front latch and push toward the rear to clear rear hook.
3. Lift top cowl to remove.

### INSTALLATION

1. Lower the top cowl into position over the engine.
2. Move the cowl toward the rear to align rear hook. After rear hook has engaged, move cowl toward front and push down front of cowl.
3. Push in the latch to secure the top cowl.

# MAINTENANCE

## Battery Inspection

The battery should be inspected at periodic intervals to ensure proper engine starting capability.

**IMPORTANT: Read the safety and maintenance instructions which accompany your battery.**

1. Turn off the engine before servicing the battery.
2. Ensure the battery is secure against movement.
3. Battery cable terminals should be clean, tight, and correctly installed. Positive to positive and negative to negative.
4. Ensure the battery is equipped with a nonconductive shield to prevent accidental shorting of battery terminals.

## Exterior Care

Your outboard is protected with a durable baked enamel finish. Clean and wax often using marine cleaners and waxes.

## Fuel System

### WARNING

**Fuel is flammable and explosive. Ensure that the key switch is off and the lanyard is positioned so that the engine cannot start. Do not smoke or allow sources of spark or open flame in the area while servicing. Keep the work area well ventilated and avoid prolonged exposure to vapors. Always check for leaks before attempting to start the engine, and wipe up any spilled fuel immediately.**

Before servicing any part of the fuel system, stop the engine and disconnect the battery. Drain the fuel system completely. Use an approved container to collect and store fuel. Wipe up any spillage immediately. Material used to contain spillage must be disposed of in an approved receptacle. Any fuel system service must be performed in a well-ventilated area. Inspect any completed service work for sign of fuel leakage.

## FUEL LINE INSPECTION

Visually inspect the fuel line and primer bulb for cracks, swelling, leaks, hardness, or other signs of deterioration or damage. If any of these conditions are found, the fuel line or primer bulb must be replaced.

# MAINTENANCE

## FUEL LINE FILTER

Inspect the fuel line filter. If the filter appears to be contaminated, remove and replace.

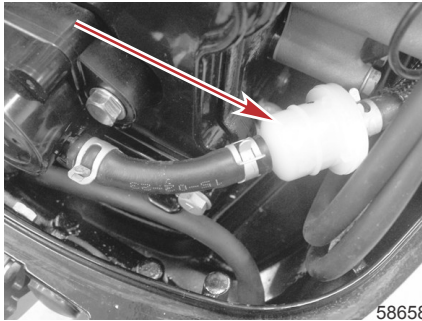

**IMPORTANT:** Inspect for fuel leakage from the filter connections by squeezing the primer bulb until firm, forcing fuel into the filter.

## Steering Link Rod Fasteners

**IMPORTANT:** The steering link rod that connects the steering cable to the engine must be fastened using the steering link rod fastening hardware supplied with engine. Never replace the locknuts (11-16147-3) with common nuts (non-locking) as they will work loose and vibrate off, freeing the link rod to disengage.

# MAINTENANCE

## ⚠ WARNING

Improper fasteners or improper installation procedures can result in loosening or disengagement of the steering link rod. This can cause a sudden, unexpected loss of boat control, resulting in serious injury or death due to occupants being thrown within or out of the boat. Always use required components and follow instructions and torque procedures.

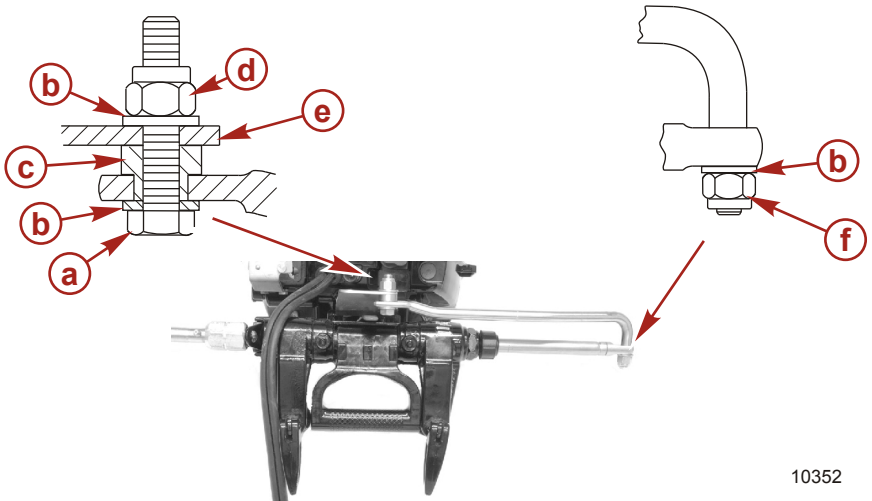

- a** - Bolt (12-71970)
- b** - Flat washer
- c** - Spacer
- d** - Nylon insert locknut (11-16147--3)
- e** - Steering bracket - Install steering link rod into side hole
- f** - Nylon insert locknut (11-16147--3) (tighten until seats then back off 1/4 turn)

Description	Nm	lb-in.	lb-ft
Nylon insert locknut "d"	27	-	20
Nylon insert locknut "f"	Tighten until seats, then back off 1/4 turn		

Assemble steering link rod to steering cable with flat washer and nylon insert locknut. Tighten locknut until it seats, then back nut off 1/4 turn.

Assemble steering link rod to engine with bolt, locknut and spacer and flat washers. Tighten the locknut to the specified torque.

# MAINTENANCE

## Corrosion Control Anode

Your outboard has a corrosion control anode installed to the gearcase. An anode helps protect the outboard against galvanic corrosion by sacrificing its metal to be slowly corroded instead of the outboard metals.

The anode requires periodic inspection especially in saltwater which will accelerate the erosion. To maintain this corrosion protection, always replace the anode before it is completely eroded. Never paint or apply a protective coating on the anode as this will reduce effectiveness of the anode.

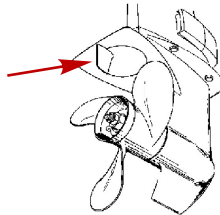

28623

## Propeller Replacement

### ⚠ WARNING

Rotating propellers can cause serious injury or death. Never operate the boat out of the water with a propeller installed. Before installing or removing a propeller, place the drive unit in neutral and engage the lanyard stop switch to prevent the engine from starting. Place a block of wood between the propeller blade and the anti-ventilation plate.

1. Remove the spark plug lead to prevent engine from starting.

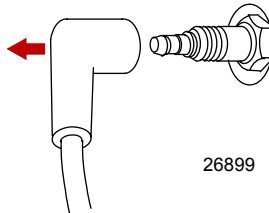

26899

# MAINTENANCE

2. Move the gear shift lever into neutral (N).

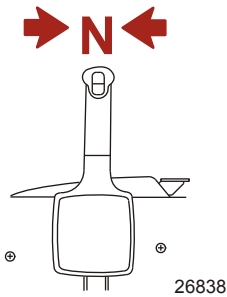

3. Straighten and remove the cotter pin.
4. Place a block of wood between the gearcase and propeller to hold the propeller and remove the propeller nut.
5. Pull the propeller straight off the shaft. If the propeller is seized to the shaft and cannot be removed, have the propeller removed by an authorized dealer.

**IMPORTANT: To prevent the propeller hub from corroding and seizing to the propeller shaft (especially in saltwater), always apply the recommended lubricant to the entire propeller shaft at the recommended maintenance intervals and also each time the propeller is removed.**

6. Apply Extreme Grease or 2-4-C with PTFE to the propeller shaft.

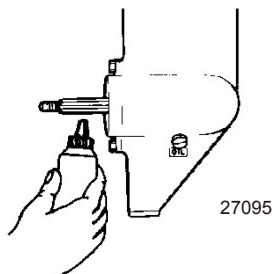

# MAINTENANCE

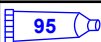
Tube Ref No.	Description	Where Used	Part No.
	Extreme Grease	Propeller shaft	8M0071842
	2-4-C with PTFE	Propeller shaft	92-802859A 1

7. Install the front thrust washer, propeller, rear thrust washer, and propeller nut onto the shaft.
8. Place a block of wood between the gearcase and propeller to prevent rotation and tighten the propeller nut. Secure the propeller nut to the shaft with the cotter pin.

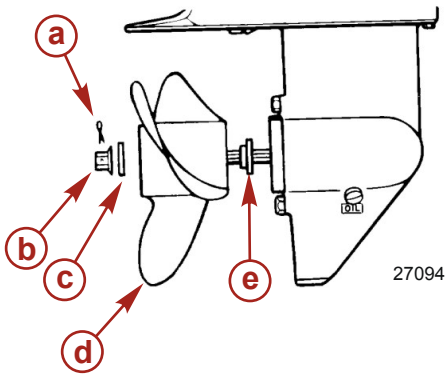

- a - Cotter pin
- b - Propeller nut
- c - Rear thrust washer
- d - Propeller
- e - Front thrust washer

## Fuse Replacement - Electric Start Models

**IMPORTANT:** Always carry spare 20 amp fuses.

The electric starting circuit is protected from overload by a 20 amp fuse. If the fuse is blown, try to locate and correct the cause of the overload. If the cause is not found, the fuse may blow again.

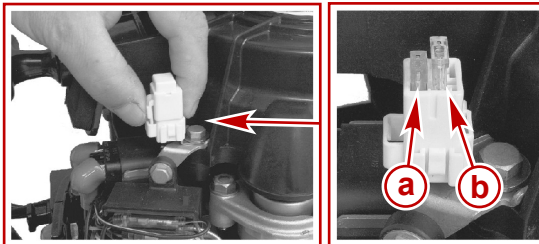

28618

- a - Spare fuse
- b - Circuit protecting fuse



# MAINTENANCE

Open the fuse holder and look at the silver colored band inside the fuse. If band is broken, replace the fuse. Replace the fuse with a new fuse with the same rating.

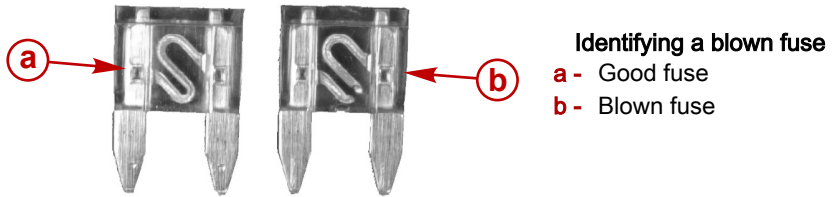

28619

## Spark Plug Inspection and Replacement

### ⚠ WARNING

Damaged spark plug boots may emit sparks that can ignite fuel vapors under the engine cowl, resulting in serious injury or death from a fire or explosion. To avoid damaging the spark plug boots, do not use any sharp object or metal tool to remove the spark plug boots.

1. Remove the spark plug boot. Twist the rubber boot slightly and pull off.

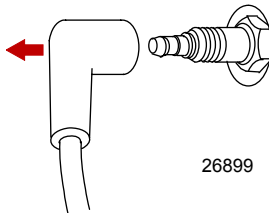

2. Remove the spark plug to inspect. Replace spark plug if electrode is worn or the insulator is rough, cracked, broken, blistered, or fouled.

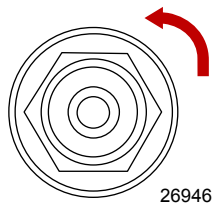

# MAINTENANCE

3. Set the spark plug gap to specification.

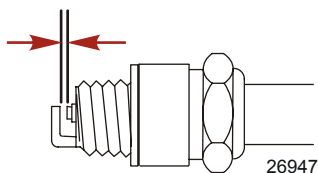

Spark Plug	
Spark plug gap	0.9 mm (0.035 in.)

4. Before installing spark plug, clean off any dirt on the spark plug seat. Install plug finger-tight, and then tighten 1/4 turn or torque to specifications.

Description	Nm	lb-in.	lb-ft
Spark plug	27		20

## Timing Belt Inspection

1. Inspect the timing belt and have it replaced by an authorized dealer if any of the following conditions are found.
  - a. Cracks in the back of the belt or in the base of the belt teeth.
  - b. Excessive wear at the roots of the cogs.
  - c. Rubber portion swollen by oil.
  - d. Belt surfaces roughened.
  - e. Signs of wear on edges or outer surfaces of belt.

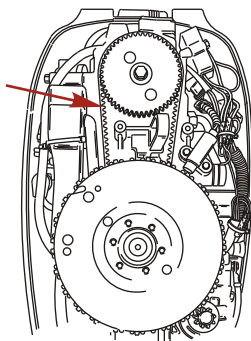

## Changing Engine Oil

### ENGINE OIL CAPACITY

Engine oil capacity is approximately 800 ml (27 fl. oz.).

# MAINTENANCE

## OIL CHANGING PROCEDURE

1. Lock the outboard in the full tilt up position.
2. Position the outboard so the drain hole is facing downward.
3. Remove the drain plug and drain the engine oil into an appropriate container.

**IMPORTANT: Do not use a crankcase oil pump when changing the oil or engine damage may occur.**

4. After the initial oil has been drained, temporarily install the drain plug. Disengage the tilt lock and lower the outboard. Wait a minute to allow the remaining oil that was trapped in the engine to return to the drain. Return the outboard to the full tilt position and drain the remaining oil.
5. Lubricate the seal on the drain plug with oil and reinstall.

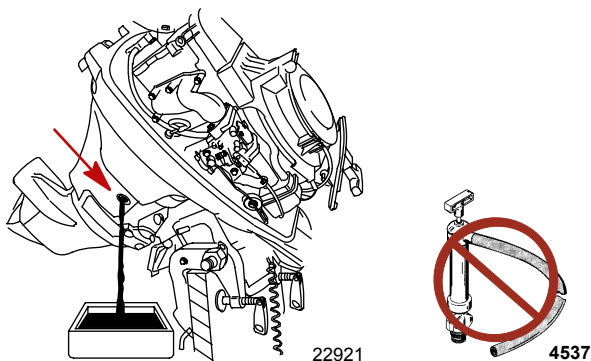

## OIL FILLING

**IMPORTANT: Do not overfill. Be sure that the outboard is upright (not tilted) when checking oil.**

1. Remove the oil fill cap and refill with 800 ml (27.0 fl. oz.) of oil. Install the oil fill cap.

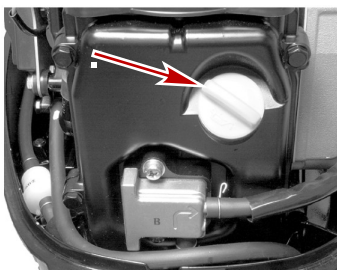



2. Idle engine for five minutes and check for leaks. Stop the engine and check the oil level on the dipstick. Add oil if necessary.

# MAINTENANCE

## Lubrication Points

1. Lubricate the following with 2-4-C with PTFE or Extreme Grease.

Tube Ref No.	Description	Where Used	Part No.
	Extreme Grease	Swivel bracket, transom clamp screws, tilt tube, throttle and shift cables, steering cable grease fitting	8M0071842
	2-4-C with PTFE	Swivel bracket, transom clamp screws, tilt tube, throttle and shift cables, steering cable grease fitting	92-802859A 1

- Swivel bracket - Lubricate fitting.
- Transom clamp screws - Lubricate threads.
- Tilt tube - Lubricate fittings.

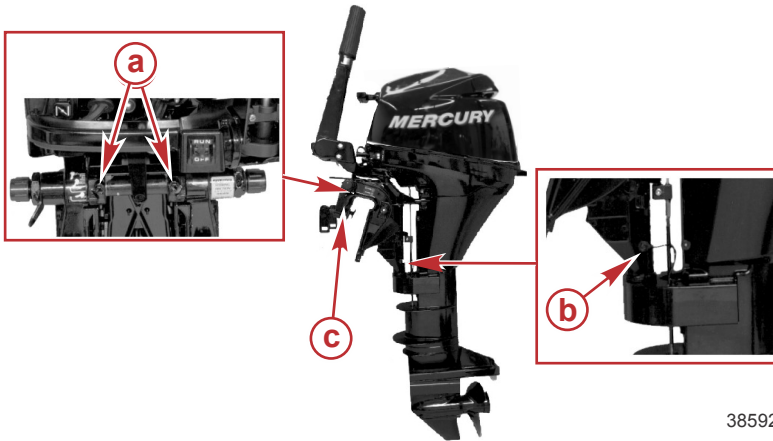

38592

- a** - Tilt tube grease fitting
- b** - Swivel bracket grease fitting
- c** - Transom clamp screws

# MAINTENANCE

- Lubricate the throttle and shift cable moving components, pivot locations, and shift detent.

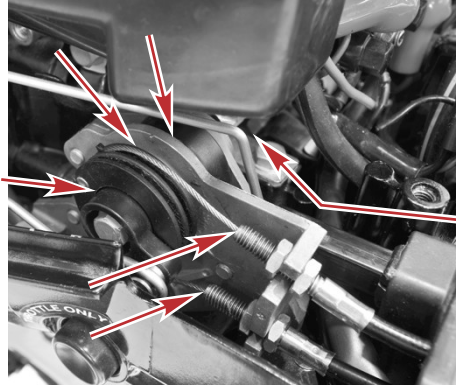

57719

- Steering cable grease fitting (if equipped) - Rotate steering wheel to fully retract the steering cable end into the outboard tilt tube. Lubricate through fitting.

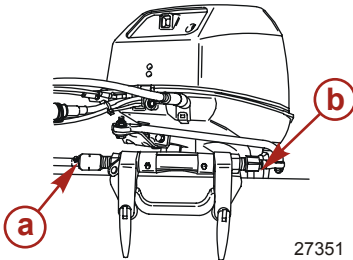

27351

- a - Steering cable grease fitting
- b - Steering cable end

## ⚠ WARNING

Incorrect cable lubrication can cause hydraulic lock, leading to serious injury or death from loss of boat control. Completely retract the end of the steering cable before applying lubricant.

2. Lubricate the following with lightweight oil.
  - Steering link rod pivot points - Lubricate points.

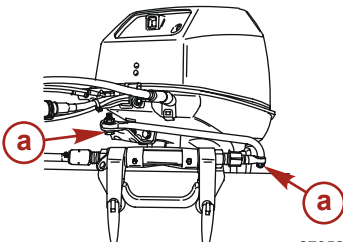



27352

- a - Steering link rod pivot points

# MAINTENANCE

3. Lubricate the following with Extreme Grease or 2-4-C with PTFE.

Tube Ref No.	Description	Where Used	Part No.
	Extreme Grease	Propeller shaft	8M0071842
<b>95</b> 	2-4-C with PTFE	Propeller shaft	92-802859A 1

- Propeller shaft - Refer to **Propeller Replacement** for removal and installation of the propeller. Apply lubricant to the entire propeller shaft to prevent the propeller hub from corroding to the shaft.

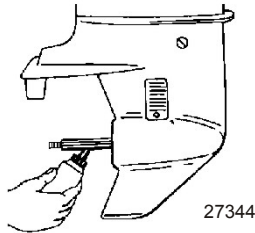

## Gearcase Lubrication

When adding or changing gearcase lubricant, visually check for the presence of water in the lubricant. If water is present, it may have settled to the bottom and will drain out prior to the lubricant, or it may be mixed with the lubricant, giving it a milky colored appearance. If water is noticed, have the gearcase checked by your dealer. Water in the lubricant may result in premature bearing failure or, in freezing temperatures, will turn to ice and damage the gearcase.

Remove the fill/drain plug and examine the lubricant draining from the gearcase for metal particles. A small amount of metal filings or fine metal particles indicates normal gear wear. An excessive amount of metal filings or larger particles (chips) may indicate abnormal gear wear and should be checked by an authorized dealer.

## DRAINING GEARCASE

1. Place the outboard in a vertical operating position.
2. Place the drain pan below outboard.

# MAINTENANCE

3. Remove the fill/drain plug and vent plug and drain lubricant.

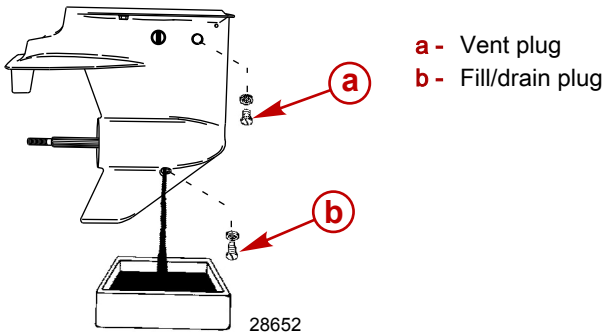

## GEARCASE LUBRICANT CAPACITY

Standard model gearcase: Approximately 320 ml (10.8 fl oz).

Command Thrust model gearcase: Approximately 370 ml (12.5 fl oz).

## GEARCASE LUBRICANT RECOMMENDATION

Mercury or Quicksilver Premium or High Performance Gear Lubricant.

## CHECKING LUBRICANT LEVEL AND REFILLING GEARCASE

1. Place the outboard in a vertical operating position.
2. Remove the vent plug from the vent hole.
3. Place the lubricant tube into the fill hole and add lubricant until it appears at the vent hole.

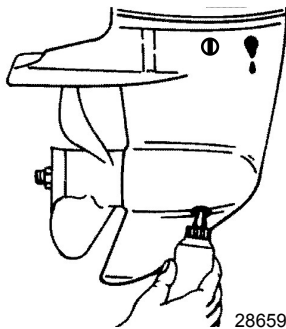

**IMPORTANT: Replace the sealing washers if damaged.**

4. Stop adding lubricant. Install the vent plug and sealing washer before removing the lubricant tube.

# MAINTENANCE

5. Remove lubricant tube and install cleaned fill/drain plug and sealing washer.

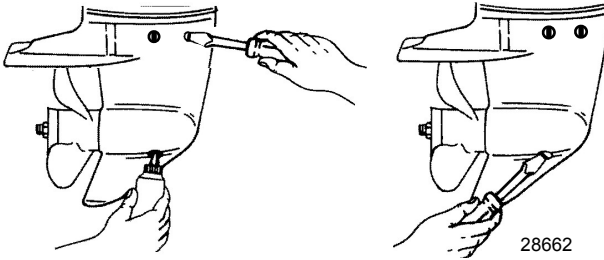

## Checking Power Tilt Fluid

1. Tilt the outboard to the full up position and engage the tilt lock lever.

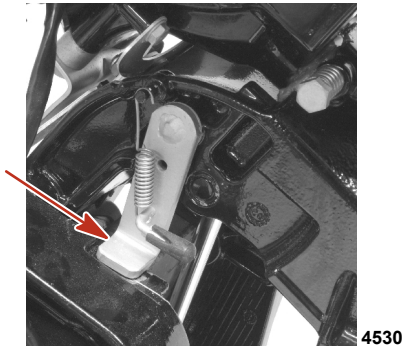

2. Remove the fill cap and check the fluid level. The fluid level should be even with the bottom of the fill hole. Add Quicksilver or Mercury Precision Lubricants Power Trim and Steering Fluid. If not available, use automotive automatic transmission fluid (ATF).

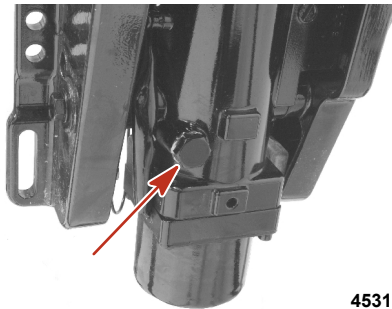



# MAINTENANCE

Tube Ref No.	Description	Where Used	Part No.
 114	Power Trim and Steering Fluid	Power tilt	92-858074K01

## Submerged Outboard

A submerged outboard will require service within a few hours by an authorized dealer once the outboard is recovered from the water. This immediate attention by a servicing dealer is necessary once the engine is exposed to the atmosphere to minimize internal corrosion damage to the engine.

# STORAGE

## Storage Preparation

The major consideration in preparing your outboard for storage is to protect it from rust, corrosion, and damage caused by freezing of trapped water.

The following storage procedures should be followed to prepare your outboard for out of season storage or prolonged storage (two months or longer).

### NOTICE

Without sufficient cooling water, the engine, the water pump, and other components will overheat and suffer damage. Provide a sufficient supply of water to the water inlets during operation.

## FUEL SYSTEM

**IMPORTANT:** Gasoline containing alcohol (ethanol or methanol) can cause a formation of acid during storage and can damage the fuel system. If the gasoline being used contains alcohol, it is advisable to drain as much of the remaining gasoline as possible from the fuel tank, remote fuel line, and engine fuel system.

Fill the fuel tank and engine fuel system with treated (stabilized) fuel to help prevent formation of varnish and gum. Proceed with the following instructions.

- Portable fuel tank - Pour the required amount of gasoline stabilizer (follow instructions on container) into fuel tank. Tip fuel tank back and forth to mix stabilizer with the fuel.
- Permanently installed fuel tank - Pour the required amount of gasoline stabilizer (follow instructions on container) into a separate container and mix with approximately 1 liter (1 U.S. quart) of gasoline. Pour this mixture into fuel tank.
- Place the outboard in water or connect flushing attachment for circulating cooling water. Run the engine for ten minutes to fill the engine fuel system.

Flushing Device	91-44357Q 2
 9192	Attaches to the water intakes; provides a fresh water connection when flushing the cooling system or operating the engine.

## Protecting External Outboard Components

- Lubricate all outboard components listed in **Maintenance - Inspection and Maintenance Schedule**.

# STORAGE

- Touch up any paint nicks. See your dealer for touch-up paint.
- Spray Quicksilver or Mercury Precision Lubricants Corrosion Guard on external metal surfaces (except corrosion control anodes).

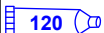
Tube Ref No.	Description	Where Used	Part No.
 120	Corrosion Guard	External metal surfaces	92-802878 55

## Protecting Internal Engine Components

- Remove the spark plugs and add approximately 30 ml (1 oz.) of engine oil or inject a five second spray of storage seal inside of each cylinder.
- Rotate the flywheel manually several times to distribute the oil in the cylinders. Install spark plugs.
- Change the engine oil.

## Gearcase

- Drain and refill the gearcase lubricant (refer to **Gearcase Lubrication**).

## Positioning Outboard for Storage

### NOTICE

Storing the outboard in a tilted position can damage the outboard. Water trapped in the cooling passages or rain water collected in the propeller exhaust outlet in the gearcase can freeze. Store the outboard in the full down position.

- To prevent problems which can be caused by oil entering the cylinders from the sump, only store the outboard in one of the three positions shown.

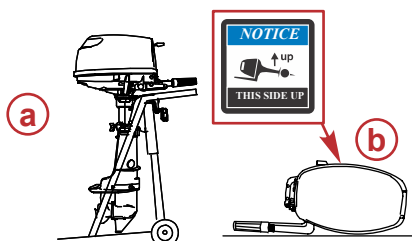

- a - Upright position
- b - Tiller handle down
- c - Front side down

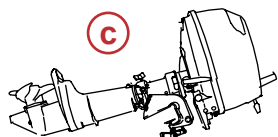

39056

# STORAGE

- Never carry, store, or transport the outboard in the two positions shown. Engine damage could result from oil draining out of the crankcase.

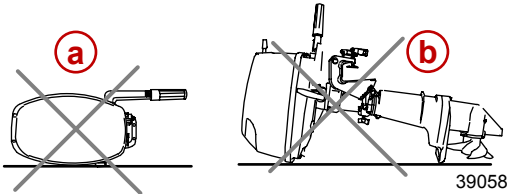

- a** - Tiller handle up
- b** - Front side up

## Battery Storage

- Follow the battery manufacturer's instructions for storage and charging.
- Remove the battery from the boat and check water level. Charge if necessary.
- Store the battery in a cool, dry place.
- Periodically check the water level and charge the battery during storage.

# TROUBLESHOOTING

## Starter Motor Will Not Crank the Engine (Electric Start Models)

### POSSIBLE CAUSES

- Blown 20 amp fuse in the starting circuit. Refer to **Maintenance** section.
- Outboard is not shifted to neutral position.
- Weak battery or battery connections are loose or corroded.
- Ignition key switch/start button failure.
- Wiring or electrical connection faulty.
- Starter motor or starter solenoid failure.

## Engine Will Not Start

### POSSIBLE CAUSES

- Lanyard stop switch not in "RUN" position.
- Battery not fully charged.
- Incorrect starting procedure. Refer to **Operation** section.
- Old or contaminated fuel.
- Fuel is not reaching the engine.
  - Fuel tank is empty.
  - Fuel tank vent not open or restricted.
  - Fuel line is disconnected or kinked.
  - Primer bulb not squeezed.
  - Primer bulb check valve is faulty.
  - Fuel filter is obstructed. Refer to **Maintenance** section.
  - Fuel pump failure.
  - Fuel tank filter obstructed.
- Open 20-amp fuse. Check fuses, refer to **Maintenance** section.
- Threaded connection of an air hose is loose.
- Ignition system component failure.
- Spark plugs fouled or defective. Refer to **Maintenance** section.

## Engine Runs Erratically

### POSSIBLE CAUSES

- Low oil pressure. Check the oil level.
- Spark plugs fouled or defective. Refer to **Maintenance** section.
- Incorrect setup and adjustments.
- Fuel is being restricted to the engine.
  - a. Engine fuel filter is obstructed. Refer to **Maintenance** section.
  - b. Fuel tank filter obstructed.

# TROUBLESHOOTING

c. Stuck anti-siphon valve located on permanently built in type fuel tanks.

d. Fuel line is kinked or pinched.

- Fuel pump failure.
- Ignition system component failure.

## Performance Loss

### POSSIBLE CAUSES

- Low oil pressure. Check the oil level.
- Throttle not fully open.
- Damaged or improper size propeller.
- Incorrect engine timing, adjustments, or setup.
- Boat overloaded or load improperly distributed.
- Excessive water in bilge.
- Boat bottom is dirty or damaged.

## Battery Will Not Hold Charge

### POSSIBLE CAUSES

- Battery connections are loose or corroded.
- Low electrolyte level in battery.
- Worn out or inefficient battery.
- Excessive use of electrical accessories.
- Defective rectifier, alternator, or voltage regulator.

# OWNER SERVICE ASSISTANCE

## Service Assistance

### LOCAL REPAIR SERVICE

If you need service for your Mercury-outboard-powered boat, take it to your authorized dealer. Only authorized dealers specialize in Mercury products and have factory-trained mechanics, special tools and equipment, and genuine Quicksilver parts and accessories to properly service your engine.

**NOTE:** *Quicksilver parts and accessories are engineered and built by Mercury Marine specifically for your power package.*

### SERVICE AWAY FROM HOME

If you are away from your local dealer and the need arises for service, contact the nearest authorized dealer. If, for any reason, you cannot obtain service, contact the nearest Regional Service Center. Outside the United States and Canada, contact the nearest Marine Power International Service Center.

### STOLEN POWER PACKAGE

If your power package is stolen, immediately advise the local authorities and Mercury Marine of the model and serial numbers and to whom the recovery is to be reported. This information is maintained in a database at Mercury Marine to aid authorities and dealers in the recovery of stolen power packages.

### ATTENTION REQUIRED AFTER SUBMERSION

1. Before recovery, contact an authorized Mercury dealer.
2. After recovery, immediate service by an authorized Mercury dealer is required to reduce the possibility of serious engine damage.

### REPLACEMENT SERVICE PARTS

#### WARNING

**Avoid fire or explosion hazard. Electrical, ignition, and fuel system components on Mercury Marine products comply with federal and international standards to minimize risk of fire or explosion. Do not use replacement electrical or fuel system components that do not comply with these standards. When servicing the electrical and fuel systems, properly install and tighten all components.**

Marine engines are expected to operate at or near full throttle for most of their lives. They are also expected to operate in both fresh and saltwater environments. These conditions require numerous special parts.

# OWNER SERVICE ASSISTANCE

## PARTS AND ACCESSORIES INQUIRIES

Direct any inquiries concerning Quicksilver replacement parts and accessories to your local authorized dealer. The dealer has the necessary information to order parts and accessories for you if they are not in stock. Only authorized dealers can purchase genuine Quicksilver parts and accessories from the factory. Mercury Marine does not sell to unauthorized dealers or retail customers. When inquiring about parts and accessories, the dealer requires the **engine model** and **serial numbers** to order the correct parts.

## RESOLVING A PROBLEM

Satisfaction with your Mercury product is important to your dealer and to us. If you ever have a problem, question or concern about your power package, contact your dealer or any authorized Mercury dealership. If you need additional assistance:

1. Talk with the dealership's sales manager or service manager. Contact the owner of the dealership if the sales manager and service manager have been unable to resolve the problem.
2. If your question, concern, or problem cannot be resolved by your dealership, please contact the Mercury Marine Service Office for assistance. Mercury Marine will work with you and your dealership to resolve all problems.

The following information will be needed by the Customer Service:

- Your name and address
- Your daytime telephone number
- The model and serial numbers of your power package
- The name and address of your dealership
- The nature of the problem

## CONTACT INFORMATION FOR MERCURY MARINE CUSTOMER SERVICE

For assistance, call, fax, or write to the geographic office in your area. Please include your daytime telephone number with mail and fax correspondence.

United States, Canada		
Telephone	English +1 920 929 5040 Français +1 905 636 4751	Mercury Marine W6250 Pioneer Road P.O. Box 1939 Fond du Lac, WI 54936-1939
Fax	English +1 920 929 5893 Français +1 905 636 1704	
Website	www.mercurymarine.com	



# OWNER SERVICE ASSISTANCE

<b>Australia, Pacific</b>		
Telephone	+61 3 9791 5822	Brunswick Asia Pacific Group 41-71 Bessemer Drive Dandenong South, Victoria 3175 Australia
Fax	+61 3 9706 7228	

<b>Europe, Middle East, Africa</b>		
Telephone	+32 87 32 32 11	Brunswick Marine Europe Parc Industriel de Petit-Rechain B-4800 Verviers, Belgium
Fax	+32 87 31 19 65	

<b>Mexico, Central America, South America, Caribbean</b>		
Telephone	+1 954 744 3500	Mercury Marine 11650 Interchange Circle North Miramar, FL 33025 U.S.A.
Fax	+1 954 744 3535	

<b>Japan</b>		
Telephone	+072 233 8888	Kisaka Co., Ltd. 4-130 Kannabecho, Sakai-ku Sakai-shi, Osaka 590-0984, Japan
Fax	+072 233 8833	

<b>Asia, Singapore</b>		
Telephone	+65 65466160	Brunswick Asia Pacific Group T/A Mercury Marine Singapore Pte Ltd 29 Loyang Drive Singapore, 508944
Fax	+65 65467789	

## Ordering Literature

Before ordering literature, have the following information about your power package available:

Model		Serial Number	
Horsepower		Year	

## UNITED STATES AND CANADA

For additional literature for your Mercury Marine power package, contact your nearest Mercury Marine dealer or contact:

# OWNER SERVICE ASSISTANCE

Mercury Marine		
Telephone	Fax	Mail
(920) 929-5110 (USA only)	(920) 929-4894 (USA only)	Mercury Marine Attn: Publications Department P.O. Box 1939 Fond du Lac, WI 54936-1939

## OUTSIDE THE UNITED STATES AND CANADA

Contact your nearest Mercury Marine authorized service center to order additional literature that is available for your particular power package.

Submit the following order form with payment to:	Mercury Marine Attn: Publications Department W6250 Pioneer Road P.O. Box 1939 Fond du Lac, WI 54936-1939
--	--

**Ship To: (Copy this form and print or type—This is your shipping label)**

<b>Name</b>	
<b>Address</b>	
<b>City, State, Province</b>	
<b>ZIP or postal code</b>	
<b>Country</b>	

Quantity	Item	Stock Number	Price	Total
			.	.
			.	.
			.	.
			.	.
			.	.
<b>Total Due</b>				.

# INSTALLATION

## Boat Horsepower Capacity

### ⚠ WARNING

Exceeding the boat's maximum horsepower rating can cause serious injury or death. Overpowering the boat can affect boat control and flotation characteristics or break the transom. Do not install an engine that exceeds the boat's maximum power rating.

Do not overpower or overload your boat. Most boats will carry a required capacity plate indicating the maximum acceptable power and load as determined by the manufacturer following certain federal guidelines. If in doubt, contact your dealer or the boat manufacturer.

U.S. COAST GUARD CAPACITY	
MAXIMUM HORSEPOWER	XXX
MAXIMUM PERSON CAPACITY (POUNDS)	XXX
MAXIMUM WEIGHT CAPACITY	XXX

26777

## Start in Gear Protection

### ⚠ WARNING

Starting the engine with the drive in gear can cause serious injury or death. Never operate a boat that does not have a neutral-safety-protection device.

The remote control connected to the outboard must be equipped with a start in neutral only protection device. This prevents the engine from starting in gear.

## Selecting Accessories for Your Outboard

Genuine Mercury Precision or Quicksilver Accessories have been specifically designed and tested for your outboard. These accessories are available from Mercury Marine dealers.

**IMPORTANT: Check with your dealer before installing accessories. The misuse of approved accessories or the use of nonapproved accessories can damage the product.**

Some accessories not manufactured or sold by Mercury Marine are not designed to be safely used with your outboard or outboard operating system. Acquire and read the installation, operation and maintenance manuals for all your selected accessories.

# INSTALLATION

## Low Permeation Fuel Hose Requirement

Required for outboards manufactured for sale, sold, or offered for sale in the United States.

- The Environmental Protection Agency (EPA) requires that any outboard manufactured after January 1, 2009, must use low permeation fuel hose for the primary fuel hose connecting the fuel tank to the outboard.
- Low permeation hose is USCG Type B1-15 or Type A1-15, defined as not exceeding 15 g/m<sup>2</sup>/24 h with CE 10 fuel at 23 °C as specified in SAE J 1527 - marine fuel hose.

## Mercury Marine Validated Engine Mounting Hardware

**IMPORTANT:** Mercury Marine provides validated fasteners and installation instructions, including torque specifications, with all of our outboards so they can be properly secured to boat transoms. Improper installation of the outboard can cause performance and reliability issues that can lead to safety concerns. Follow all of the instructions relating to the outboard installation. **DO NOT** mount any other accessory onto the boat with the fasteners provided with the outboard. For example, do not mount tow sport bars or boarding ladders onto the boat using the mounting hardware included with the outboard. Installing other products onto the boat that utilize the outboard mounting hardware will compromise the ability of that hardware to properly and safely secure the outboard to the transom.

Outboards that require validated mounting hardware will have the following decal on the transom clamp.



51965

# INSTALLATION

## Installing Outboard

### ⚠ WARNING

Failure to correctly fasten the outboard could result in the outboard propelling off the boat transom resulting in property damage, serious injury, or death. Before operation, the outboard must be correctly installed with the required mounting hardware.

### BOAT TRANSOM HEIGHT REQUIREMENT

Measure the transom height of your boat. The boat bottom should be aligned or be within 25 mm (1 in.) above the anti-ventilation plate of the outboard.

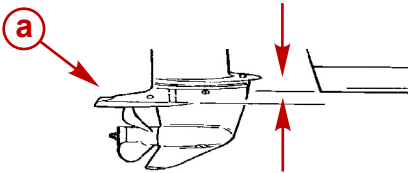

a - Anti-ventilation plate

27151

## INSTALLING OUTBOARD ON TRANSOM

### ⚠ WARNING

Failure to correctly fasten the outboard could result in the outboard propelling off the boat transom resulting in property damage, serious injury, or death. Before operation, the outboard must be correctly installed with the required mounting hardware.

This product must be secured to the transom with the required mounting hardware. If the outboard strikes an underwater object, the required mounting hardware prevents the outboard from propelling off the transom. A decal on the swivel bracket reminds the installer of the potential hazard.

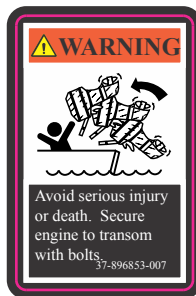

52375

# INSTALLATION

1. Place the outboard on the centerline of the transom.

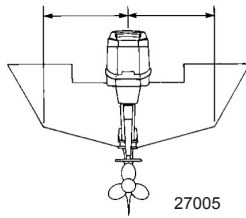

2. Tighten the transom bracket clamp screws.

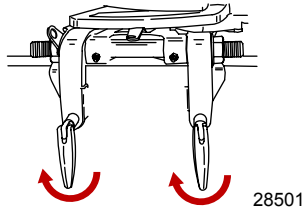

3. Nonpower tilt models - To prevent a loss of the outboard, secure the outboard to the transom with the two transom bracket clamp screws and two mounting bolts. Drill two 7.9 mm (5/16 in.) holes through-the-transom bracket mounting holes. Fasten with two bolts, flat washers, and locknuts. Use a marine waterproofing sealer in the holes and around the bolts to make the installation watertight. Tighten the bolts to the specified torque.

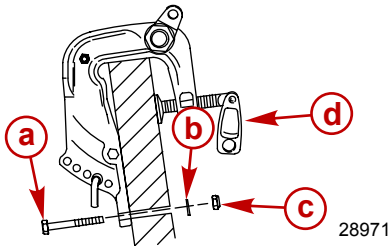

- a** - Bolts (2)
- b** - Washer (2)
- c** - Locknut (2)
- d** - Transom bracket clamp screws (2)

Description	Nm	lb-in.	lb-ft
Transom bracket mounting bolts	13.5	-	10

# INSTALLATION

- Power tilt models - To prevent a loss of the outboard, secure the outboard to the transom with the two transom bracket clamp screws and four mounting bolts. Drill two 7.9 mm (5/16 in.) holes through the upper set of transom bracket mounting holes and drill two holes through the lower set of mounting holes or mounting slots. Fasten with four bolts, flat washers, and locknuts. Use a marine waterproofing sealer in the holes and around the bolts to make the installation watertight. Tighten the bolts to the specified torque.

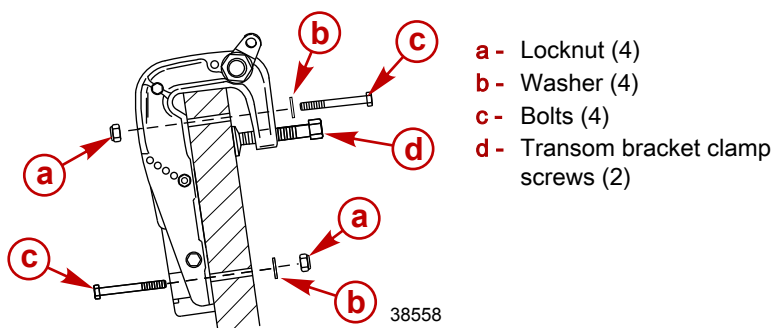

Description	Nm	lb-in.	lb-ft
Transom bracket mounting bolts	13.5	-	10

## Remote Control Installation

### STEERING CABLE

- Lubricate the entire cable end with Mercury Precision or Quicksilver 2-4-C with PTFE.

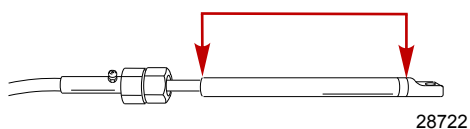

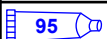
Tube Ref No.	Description	Where Used	Part No.
 95	2-4-C with PTFE	Steering cable end	92-802859A 1

# INSTALLATION

2. Insert the steering cable into the tilt tube.

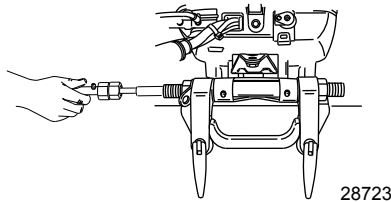

3. Tighten the steering cable nut to the specified torque.

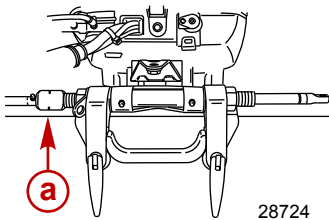

**a** - Steering cable nut

Description	Nm	lb-in.	lb-ft
Steering cable nut	47.5	–	35

## Steering Link Rod Fasteners

**IMPORTANT:** The steering link rod that connects the steering cable to the engine must be fastened using the steering link rod fastening hardware supplied with engine. Never replace the locknuts (11-16147-3) with common nuts (non-locking) as they will work loose and vibrate off, freeing the link rod to disengage.



# INSTALLATION

## ⚠ WARNING

Improper fasteners or improper installation procedures can result in loosening or disengagement of the steering link rod. This can cause a sudden, unexpected loss of boat control, resulting in serious injury or death due to occupants being thrown within or out of the boat. Always use required components and follow instructions and torque procedures.

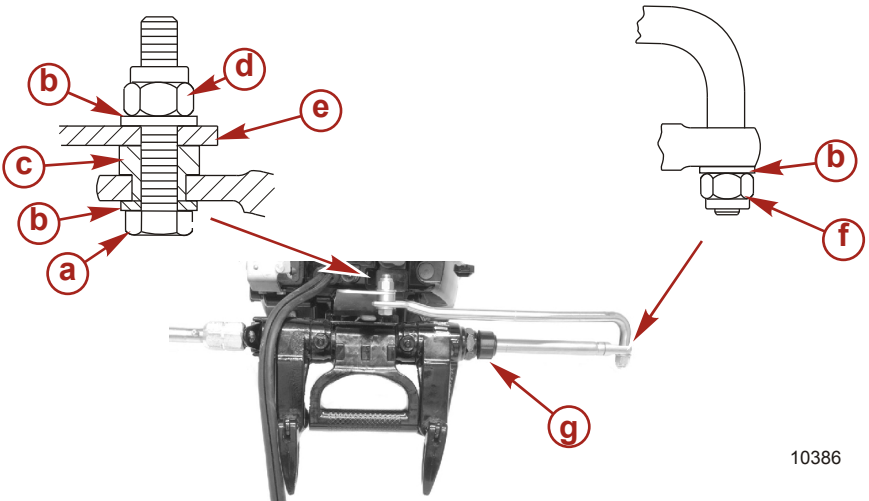

10386

- a** - Bolt (12-71970)
- b** - Flat washer
- c** - Spacer
- d** - Nylon insert locknut (11-16147--3)
- e** - Steering bracket - Install steering link rod into side hole
- f** - Nylon insert locknut (11-16147--3) (tighten until seats then back off 1/4 turn)
- g** - Seal

Description	Nm	lb-in.	lb-ft
Nylon insert locknut "d"	27	-	20
Nylon insert locknut "f"	Tighten until seats, then back off 1/4 turn		

Assemble steering link rod to steering cable with flat washer and nylon insert locknut. Tighten locknut until it seats, then back nut off 1/4 turn.

Assemble steering link rod to engine with bolt, locknut and spacer and flat washers. Tighten locknut to the specified torque.

# INSTALLATION

## Remote Wire Harness Connection

1. Remove the cover and cable receptacle bracket from the bottom cowl.

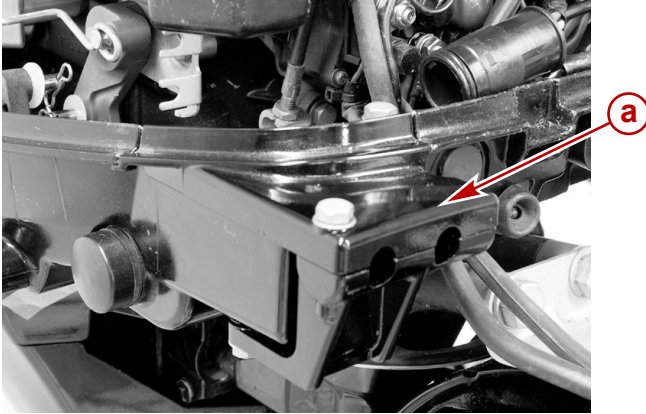

28003

**a - Cover**

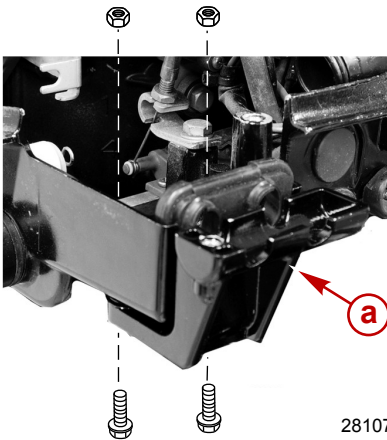

**a - Cable receptacle bracket**

28107

2. Route the remote wiring harness through the rubber grommet.

# INSTALLATION

3. Open up the clamp in the bottom cowl and position the remote wiring harness below the clamp. Connect the 8 pin connector to the engine harness. Push the clamp down and secure the remote wiring harness into the bottom cowl.

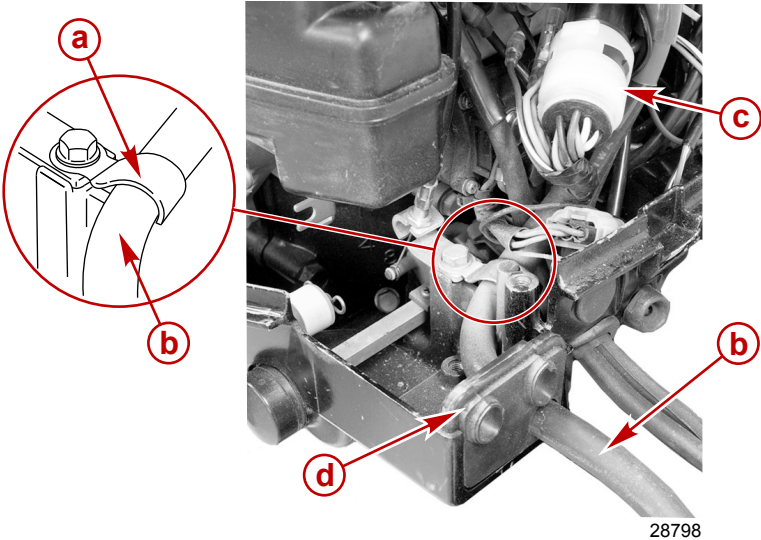

- a - Clamp
- b - Remote wiring harness
- c - 8 pin connector
- d - Rubber grommet

4. Install the cable receptacle bracket with two bolts and hex nuts. Tighten the bolts to the specified torque.

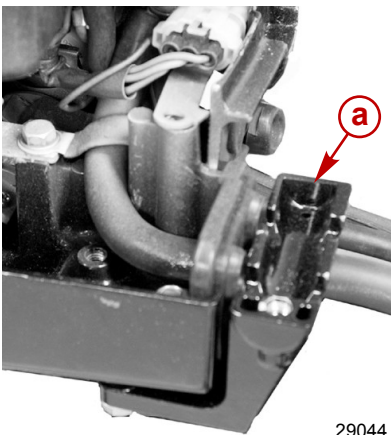

- a - Cable receptacle bracket

# INSTALLATION

Description	Nm	lb-in.	lb-ft
Cable receptacle bracket	6	53	

## Control Cable Installation

### THROTTLE CABLE INSTALLATION

Install the cables into the remote control following the instructions provided with the remote control.

1. Position the remote control handle into full forward throttle position.

**NOTE:** *The throttle cable is the second cable to move when moving the control box out of neutral.*

2. Attach the throttle cable end guide to the throttle lever with a washer and cotter pin retainer.
3. Adjust the cable barrel so that the installed throttle cable will hold the throttle level against the throttle stop.
4. Position the throttle cable into the rubber grommet and place the cable barrel into the barrel receptacle.
5. Move the remote control handle to the full throttle position and check to make sure that the throttle cable end guide does not contact the remote control harness.

# INSTALLATION

**IMPORTANT:** Make sure that the throttle cable end guide does not contact the remote wiring harness when the throttle cable is at full throttle position. If necessary, position and clamp the remote wiring harness.

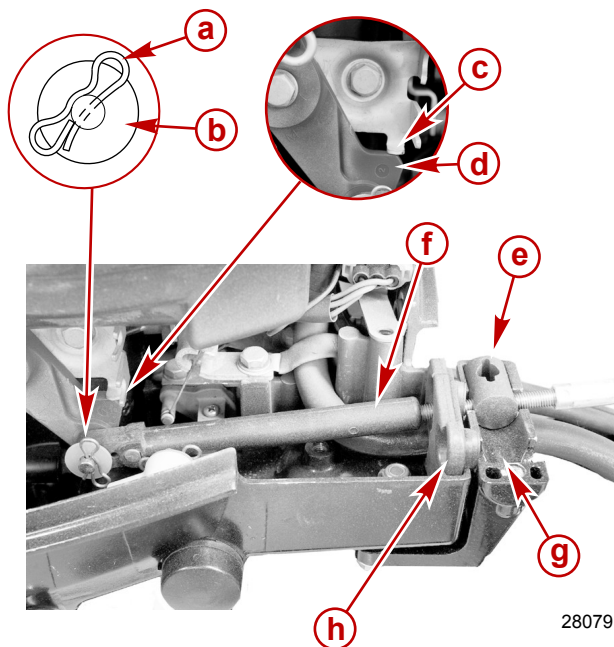

- a** - Cotter pin retainer
- b** - Flat washer
- c** - Full throttle stop
- d** - Throttle lever
- e** - Cable barrel
- f** - Throttle cable end guide
- g** - Barrel receptacle
- h** - Rubber grommet

## SHIFT CABLE INSTALLATION

Install the cables into the remote control following the instructions provided with the remote control.

1. Locate the center point of the slack or lost motion that exists in the shift cable as follows:
  - a. Move the remote control handle from neutral into forward and advance the handle to full speed position. Slowly return the handle back to the neutral. Place a mark ("a") on the cable next to the end guide.

# INSTALLATION

- b. Move the remote control handle from neutral into reverse and advance the handle to full speed position. Slowly return the handle back to the neutral. Place a mark ("b") on the cable next to the end guide.
- c. Make a center mark ("c"), midway between marks ("a" and "b"). Align the end guide with this center mark when installing cable to the engine.

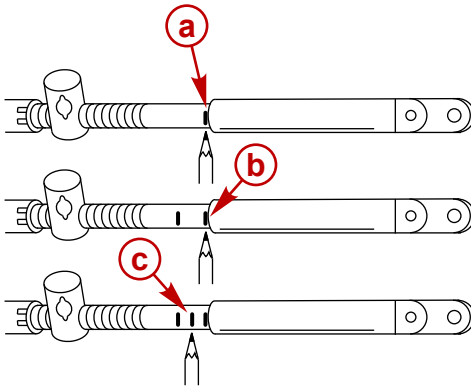

6098

2. Manually shift the outboard into neutral (propeller will rotate freely).
3. Position the remote control handle into neutral.
4. Attach the shift cable to the shift lever with a washer and cotter pin retainer.
5. Adjust the cable barrel so the center mark on the cable is aligned with the end guide when the cable barrel is placed in the barrel receptacle.

# INSTALLATION

6. Position the shift cable into the rubber grommet and place the cable barrel into the barrel receptacle.

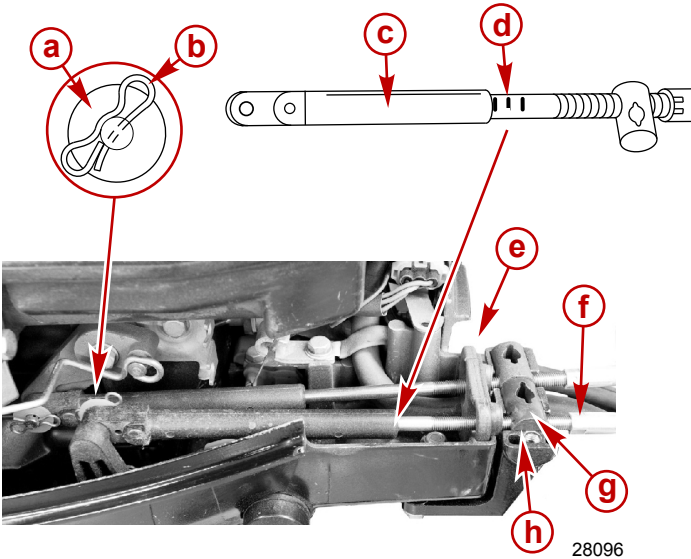

- a** - Flat washer
- b** - Cotter pin retainer
- c** - End guide
- d** - Center mark
- e** - Rubber grommet
- f** - Shift cable
- g** - Cable barrel
- h** - Barrel receptacle

# INSTALLATION

7. Install the access cover with two bolts. Tighten the bolts to the specified torque.

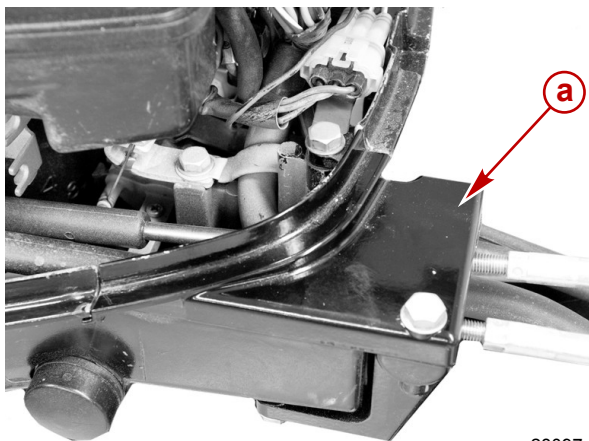

28097

**a** - Access cover

Description	Nm	lb-in.	lb-ft
Access cover bolt	6	53	

8. Check shift cable adjustments as follows:
  - a. Shift remote control into forward. The propeller shaft should be locked in gear. If not, adjust the barrel closer to the cable guide.
  - b. Shift remote control into reverse while turning propeller. The propeller shaft should be locked in gear. If not, adjust the barrel away from the cable guide. Repeat steps a through c.
  - c. Shift remote control back to neutral. The propeller shaft should turn freely without drag. If not, adjust the barrel closer to the cable guide. Repeat steps a through c.

## Battery Installation - Electric Start Models

### MOUNTING BATTERY

Follow the battery manufacturer's instructions carefully. Mount battery in the boat so it is secured against movement, preferably in a battery box. Make sure battery is equipped with a nonconductive shield to prevent accidental shorting of battery terminals.

**NOTE:** *Electric starting outboards must have the battery cables connected to a battery whenever the engine is running, even if started manually, as damage to the charging system could result.*



# INSTALLATION

## Battery Connections

### CONNECTING OUTBOARD BATTERY CABLES

First, connect the red battery cable to the (+) positive battery terminal and then connect the black battery cable to the (-) negative battery terminal.

### DISCONNECTING OUTBOARD BATTERY CABLES

First, disconnect the black battery cable from the (-) negative terminal and then disconnect the red battery cable from the (+) positive terminal.

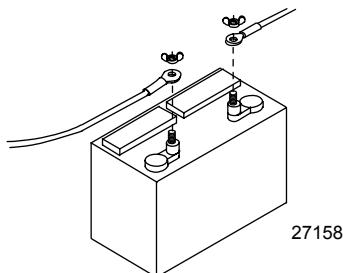



## Propeller Installation

### ⚠ WARNING

Rotating propellers can cause serious injury or death. Never operate the boat out of the water with a propeller installed. Before installing or removing a propeller, place the drive unit in neutral and engage the lanyard stop switch to prevent the engine from starting. Place a block of wood between the propeller blade and the anti-ventilation plate.

1. To aid in future removal of the propeller, liberally coat the propeller shaft splines with one of the following Mercury/Quicksilver products:

Tube Ref No.	Description	Where Used	Part No.
	Extreme Grease	Propeller shaft splines	8M0071842
	2-4-C with PTFE	Propeller shaft splines	92-802859A 1

2. Install the front thrust washer, propeller, rear thrust hub, and propeller nut onto the shaft.

# INSTALLATION

- Place a block of wood between gearcase and propeller to prevent rotation and tighten propeller nut. Secure propeller nut to the shaft with the cotter pin.

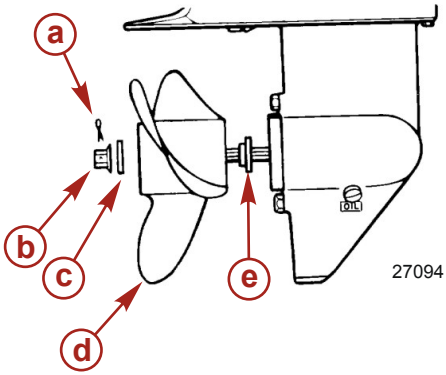

- a** - Cotter pin
- b** - Propeller nut
- c** - Rear thrust washer
- d** - Propeller
- e** - Front thrust washer

# MAINTENANCE LOG

## Maintenance Log

Record all maintenance performed on your outboard here. Be sure to save all work orders and receipts.

Date	Maintenance Performed	Engine Hours