

## Declaration of Conformity

The outboard engines covered by this Declaration of Conformity are not intended for installation on recreational craft in the European Union. These engines do not conform to the exhaust and noise emission requirements of the Recreational Craft Directive 94/25/EC as amended by 2003/44/EC.

This outboard motor manufactured by Mercury Marine, Fond du Lac, WI, USA complies with the requirements of the following directives and standards, as amended:

<b>Name of engine manufacturer:</b> Mercury Marine
<b>Address:</b> W6250 Pioneer Road, P.O. Box 1939
<b>Town:</b> Fond du Lac, WI <b>Post Code:</b> 54936-1939 <b>Country:</b> USA

<b>Name of authorized representative:</b> Brunswick Marine in EMEA Inc.
<b>Address:</b> Parc Industriel de Petit-Rechain
<b>Town:</b> Verviers <b>Post Code:</b> B-4800 <b>Country:</b> Belgium

### Safety of Machinery Directive    2006/42/EC

Principles of safety integration (1.1.2)	ISO 12100-1; ISO 12100-2; EN 1050
Noise (1.5.8)	ICOMIA 39/94
Vibration (1.5.9)	ICOMIA 38/94

### Electromagnetic Compatibility Directive    2004/108/EC

Generic emission standard	EN 61000-6-3
Generic immunity standard	EN 61000-6-1
Vehicles, boats and internal combustion engine driven devices - radio disturbance characteristics	SAE J551 CISPR 12; EN 55012:2002/A1: 2005
Electrostatic discharge testing	EN 61000-6-2; EN 61000-4-2; EN 61000-4-3

### Marine Equipment Directive:    2004/108/EC

EC type examination (Module B) Certificate No.	MED-B-6670
Issue date	January 1, 2011 by the notified body (DNV No 0575)
EC certificate of conformity (Module D) No.	MED-D-1449
Issue date	January 24, 2011 by the notified body (DNV No 0575)
Engine type	Outboard: 40 hp, 55 hp, 60 hp, 75 hp, 90 hp
Fuel type	Gasoline
Combustion cycle	2-stroke

This declaration is issued under the sole responsibility of Mercury Marine and Brunswick Marine in EMEA Inc. I declare on behalf of the engine manufacturer that the engines mentioned preceding complies with all applicable essential requirements in the way specified.

**Name / function:**

Mark D. Schwabero, President, Mercury Outboard



**Date and place of issue:**

January 01, 2011  
Fond du Lac, Wisconsin, USA

**Welcome!**

With proper care and maintenance, you will thoroughly enjoy using this product for many boating seasons. To ensure maximum performance and carefree use, we ask that you read this manual.

The Operation, Maintenance and Warranty Manual contains specific instructions for using and maintaining your product. We suggest that this manual remain with the product for ready reference whenever you are on the water.

Thank you for purchasing one of our products. We sincerely hope your boating will be pleasant!

## Warranty Message

The product you have purchased comes with a limited warranty from Mercury Marine. The terms of the warranty are set forth in the **Warranty Information** section of this manual. The warranty statement contains a description of what is covered, what is not covered, the duration of coverage, how to best obtain warranty coverage, important disclaimers and limitations of damages, and other related information. Please review this important information.

The description and specifications contained herein were in effect at the time this manual was approved for printing. Mercury Marine, whose policy is one of continued improvement, reserves the right to discontinue models at any time, to change specifications, designs, methods, or procedures without notice and without incurring obligation.

Mercury Marine, Fond du Lac, Wisconsin U.S.A.

## Copyright and Trademark Information

**© MERCURY MARINE. All rights reserved. Reproduction in whole or in part without permission is prohibited.**

Alpha, Axius, Bravo One, Bravo Two, Bravo Three, Circle M with Waves Logo, K-planes, Mariner, MerCathode, MerCruiser, Mercury, Mercury with Waves Logo, Mercury Marine, Mercury Precision Parts, Mercury Propellers, Mercury Racing, MotorGuide, OptiMax, Quicksilver, SeaCore, Skyhook, SmartCraft, Sport-Jet, Verado, VesselView, Zero Effort, Zeus, #1 On the Water and We're Driven to Win are registered trademarks of Brunswick Corporation. Pro XS is a trademark of Brunswick Corporation. Mercury Product Protection is a registered service mark of Brunswick Corporation.



---

## WARRANTY INFORMATION

---

Transfer of Warranty.....	1
Warranty Registration United States and Canada.....	1
Warranty Registration Outside the United States and Canada.....	2
Outboard Limited Warranty United States, Canada, and Europe.....	3
Outboard Limited Warranty (Confederation of Independent States, Middle-East, and Africa).....	5
3 Year Limited Warranty Against Corrosion.....	7
Warranty Coverage and Exclusions.....	9
Warranty Policy—Australia and New Zealand.....	11
Global Warranty Charts Outboard and Jets.....	15

---

### General Information

---

Boater's Responsibilities.....	20
Before Operating Your Outboard.....	20
Boat Horsepower Capacity.....	20
High-Speed and High-Performance Boat Operation.....	21
Outboard Remote Control Models .....	21
Remote Steering Notice.....	22
Lanyard Stop Switch.....	22
Protecting People in the Water.....	25
Passenger Safety Message - Pontoon Boats and Deck Boats.....	25
Wave and Wake Jumping.....	27
Impact with Underwater Hazards.....	28
Safety Instructions for Hand-Tilled Outboards.....	29
Exhaust Emissions.....	29
Selecting Accessories for Your Outboard.....	31
Safe Boating Recommendations.....	31
Recording Serial Number.....	34
55/60 SeaPro/Marathon Specifications.....	34
60 Component Identification.....	36
55/60 SeaPro/Marathon Component Identification.....	37

---

### Transporting

---

Trailer Boat/Outboard .....	38
-----------------------------	----

---

## Fuel and Oil

---

Fuel Recommendations.....	39
Oil Recommendation.....	40
Fuel and Oil Ratio.....	40
Filling Oil Injection System.....	41
Filling Remote Oil Tank (If Equipped).....	41
Filling Fuel Tank.....	42

---

## Features and Controls

---

Remote Control Features.....	43
Warning System.....	44
Engine Over-Speed Limiter.....	45
Power Trim And Tilt (If equipped).....	46
Manual Tilt System.....	49
Throttle Grip Friction Adjustment - Tiller Handle Models.....	53
Steering Friction Adjustment - Tiller Handle Models.....	53
Trim Tab Adjustment.....	54

---

## Operation

---

Important Daily Inspection Before Each Use .....	55
Prestarting Check List.....	55
Operating in Freezing Temperatures.....	56
Operating in Saltwater or Polluted Water.....	56
Effects of Elevation and Weather on Performance.....	56
Operating at High Elevations.....	57
Engine Break-in Procedure.....	57
Starting The Engine.....	57
Gear Shifting.....	61
Stopping the Engine .....	62
Emergency Starting .....	63

---

## Maintenance

---

Outboard Care.....	66
EPA Regulations.....	66
EPA Emissions.....	67
Inspection and Maintenance Schedule.....	67
Flushing the Cooling System.....	68
Top Cowl Removal And Installation.....	70
Battery Inspection .....	70
Fuel System.....	71
Steering Link Rod Fasteners.....	74
Fuse Replacement.....	75
Corrosion Control Anode.....	76
Propeller Replacement–Standard Gearcase.....	77
Propeller Replacement–Command Thrust Gearcase.....	80
Spark Plug Inspection and Replacement.....	83
Lubrication Points.....	84
Lubrication Points–Sea Pro/Marathon Models.....	86
Checking Power Trim Fluid.....	88
Gearcase Lubrication.....	88
Submerged Outboard.....	90

---

## Storage

---

Storage Preparation.....	91
Protecting External Outboard Components.....	91
Protecting Internal Engine Components.....	92
Gearcase.....	92
Positioning Outboard for Storage.....	92
Battery Storage.....	92

---

## Troubleshooting

---

Starter Motor Will Not Crank the Engine (Electric Start Models).....	93
Engine Will Not Start.....	93
Engine Runs Erratically.....	93
Performance Loss.....	94
Battery Will Not Hold Charge.....	94

---

## Owner Service Assistance

---

Local Repair Service.....	95
Service Away from Home.....	95
Parts and Accessories Inquiries.....	95
Service Assistance.....	95
Ordering Literature.....	98

---

## Installation

---

Mercury Marine Validated Engine Mounting Hardware.....	100
Accessories Mounted to the Transom Clamp Bracket.....	100
Installing Outboard.....	104
Propeller Selection.....	106

---

## Maintenance Log

---

Maintenance Log.....	107
----------------------	-----



# WARRANTY INFORMATION

## Transfer of Warranty

The limited warranty is transferable to a subsequent purchaser, but only for the remainder of the unused portion of the limited warranty. This will not apply to products used for commercial applications.

To transfer the warranty to the subsequent owner, send or fax a copy of the bill of sale or purchase agreement, new owner's name, address and engine serial number to Mercury Marine's Warranty Registration Department. In the United States and Canada, mail to:

Mercury Marine  
Attn: Warranty Registration Department  
W6250 Pioneer Road  
P.O. Box 1939  
Fond du Lac, WI 54936-1939  
920-929-5054  
Fax +1 920 907 6663

Upon processing the transfer of warranty, Mercury Marine will send registration verification to the new owner of the product by mail.

There is no charge for this service.

For products purchased outside the United States and Canada, contact the distributor in your country, or the Marine Power Service Center closest to you.

## Warranty Registration United States and Canada

1. You may change your address at any time, including at time of warranty claim, by calling Mercury Marine or sending a letter or fax with your name, old address, new address, and engine serial number to Mercury Marine's Warranty Registration Department. Your dealer can also process this change of information.

Mercury Marine  
Attn: Warranty Registration Department  
W6250 Pioneer Road  
P.O. Box 1939  
Fond du Lac, WI 54936-1939  
920-929-5054  
Fax 920-907-6663

**NOTE:** *Registration lists must be maintained by Mercury Marine and any dealer on marine products sold in the United States, should a safety recall notification under the Federal Safety Act be required.*

# WARRANTY INFORMATION

2. To be eligible for warranty coverage, the product must be registered with Mercury Marine. At the time of sale, the dealer should complete the warranty registration and immediately submit it to Mercury Marine via MercNET, E-mail, or mail. Upon receipt of this warranty registration, Mercury Marine will record the registration.
3. Upon processing the warranty registration, Mercury Marine will send registration verification by mail to the purchaser of the product. If this registration verification is not received within 30 days, please contact your selling dealer immediately. Warranty coverage is not effective until your product is registered with Mercury Marine.

## Warranty Registration Outside the United States and Canada

1. It is important that your selling dealer fills out the Warranty Registration Card completely and mails it to the distributor or Marine Power Service Center responsible for administering the warranty registration/claim program for your area.
2. The Warranty Registration Card identifies your name and address, product model and serial numbers, date of sale, type of use and the selling distributor's/dealer's code number, name and address. The distributor/dealer also certifies that you are the original purchaser and user of the product.
3. A copy of the Warranty Registration Card, designated as the Purchaser's Copy, MUST be given to you immediately after the card has been completely filled out by the selling distributor/dealer. This card represents your factory registration identification and should be retained by you for future use when required. Should you ever require warranty service on this product, your dealer may ask you for the Warranty Registration Card to verify date of purchase and to use the information on the card to prepare the warranty claim forms.
4. In some countries, the Marine Power Service Center will issue you a permanent (plastic) Warranty Registration Card within 30 days after receiving the Factory Copy of the Warranty Registration Card from your distributor/dealer. If you receive a plastic Warranty Registration Card, you may discard the Purchaser's Copy that you received from the distributor/dealer when you purchased the product. Ask your distributor/dealer if this plastic card program applies to you.

**IMPORTANT: Registration lists must be maintained by the factory and dealer in some countries by law. It is our desire to have ALL products registered at the factory should it ever be necessary to contact you. Make sure your dealer/distributor fills out the warranty registration card immediately and sends the factory copy to the Marine Power International Service Center for your area.**

5. For further information concerning the Warranty Registration Card and its relationship to Warranty Claim processing, refer to the International Warranty.

# WARRANTY INFORMATION

## Outboard Limited Warranty United States, Canada, and Europe

Outside the United States, Canada, and Europe - check with local distributor.

**WHAT IS COVERED:** Mercury Marine warrants its new Outboard and Jet Products to be free of defects in material and workmanship during the period described below.

**DURATION OF COVERAGE:** This Limited Warranty provides coverage for two (2) years from the date the product is first sold to a recreational use retail purchaser, or the date on which the product is first put into service, whichever occurs first. Commercial users of these products receive warranty coverage of one (1) year from the date of first retail sale, or one (1) year from the date in which the product was first put into service, whichever occurs first. Commercial use is defined as any work or employment related use of the product, or any use of the product which generates income, for any part of the warranty period, even if the product is only occasionally used for such purposes. The repair or replacement of parts, or the performance of service under this warranty, does not extend the life of this warranty beyond its original expiration date. Unexpired warranty coverage can be transferred from one recreational use customer to a subsequent recreational use customer upon proper reregistration of the product. Unexpired warranty coverage cannot be transferred either to or from a commercial use customer.

### **CONDITIONS THAT MUST BE MET IN ORDER TO OBTAIN WARRANTY**

**COVERAGE:** Warranty coverage is available only to retail customers that purchase from a Dealer authorized by Mercury Marine to distribute the product in the country in which the sale occurred, and then only after the Mercury Marine specified predelivery inspection process is completed and documented. Warranty coverage becomes available upon proper registration of the product by the authorized dealer. Routine maintenance outlined in the Operation and Maintenance Manual must be timely performed in order to maintain warranty coverage. Mercury Marine reserves the right to make future warranty coverage contingent on proof of proper maintenance.

**WHAT MERCURY WILL DO:** Mercury's sole and exclusive obligation under this warranty is limited to, at our option, repairing a defective part, replacing such part or parts with new or Mercury Marine certified remanufactured parts, or refunding the purchase price of the Mercury product. Mercury reserves the right to improve or modify products from time to time without assuming an obligation to modify products previously manufactured.

# WARRANTY INFORMATION

**HOW TO OBTAIN WARRANTY COVERAGE:** The customer must provide Mercury with a reasonable opportunity to repair, and reasonable access to the product for warranty service. Warranty claims shall be made by delivering the product for inspection to a Mercury dealer authorized to service the product. If purchaser cannot deliver the product to such a dealer, written notice must be given to Mercury. We will then arrange for the inspection and any covered repair. Purchaser, in that case, shall pay for all related transportation charges and/or travel time. If the service provided is not covered by this warranty, purchaser shall pay for all related labor and material, and any other expenses associated with that service. Purchaser shall not, unless requested by Mercury, ship the product or parts of the product directly to Mercury. Proof of registered ownership must be presented to the dealer at the time warranty service is requested in order to obtain coverage.

**WHAT IS NOT COVERED:** This limited warranty does not cover routine maintenance items, tune ups, adjustments, normal wear and tear, faded paint, damage caused by abuse, abnormal use, use of a propeller or gear ratio that does not allow the engine to run in its recommended wide-open throttle RPM range (see the Operation and Maintenance Manual), operation of the product in a manner inconsistent with the recommended operation/duty cycle section of the Operation and Maintenance Manual, neglect, accident, submersion, improper installation (proper installation specifications and techniques are set forth in the installation instructions for the product), improper service, use of an accessory or part not manufactured or sold by us, jet pump impellers and liners, operation with fuels, oils, or lubricants which are not suitable for use with the product (see the Operation and Maintenance Manual), alteration or removal of parts, or water entering the engine through the fuel intake, air intake, or exhaust system, or damage to the product from insufficient cooling water caused by blockage of the cooling system by a foreign body, running the engine out of water, mounting the engine too high on the transom, or running the boat with the engine trimmed out too far. Use of the product for racing or other competitive activity, or operating with a racing type lower unit, at any point, even by a prior owner of the product, voids the warranty.

Expenses related to haul-out, launch, towing, storage, telephone, rental, inconvenience, slip fees, insurance coverage, loan payments, loss of time, loss of income, or any other type of incidental or consequential damages are not covered by this warranty. Also, expenses associated with the removal and/or replacement of boat partitions or material caused by boat design for access to the product are not covered by this warranty.

No individual or entity, including Mercury Marine authorized dealers, has been given authority by Mercury Marine to make any affirmation, representation, or warranty regarding the product, other than those contained in this limited warranty, and if made, shall not be enforceable against Mercury Marine.

For additional information regarding events and circumstances covered by this warranty, and those that are not, see the Warranty Coverage section of the Operation and Maintenance Manual, incorporated by reference into this warranty.

# WARRANTY INFORMATION

## DISCLAIMERS AND LIMITATIONS:

THE IMPLIED WARRANTIES OF MERCHANTABILITY AND FITNESS FOR A PARTICULAR PURPOSE ARE EXPRESSLY DISCLAIMED. TO THE EXTENT THAT THEY CANNOT BE DISCLAIMED, THE IMPLIED WARRANTIES ARE LIMITED IN DURATION TO THE LIFE OF THE EXPRESS WARRANTY. INCIDENTAL AND CONSEQUENTIAL DAMAGES ARE EXCLUDED FROM COVERAGE UNDER THIS WARRANTY. SOME STATES/COUNTRIES DO NOT ALLOW FOR THE DISCLAIMED, LIMITATIONS AND EXCLUSIONS IDENTIFIED ABOVE, AS A RESULT, THEY MAY NOT APPLY TO YOU. THIS WARRANTY GIVES YOU SPECIFIC LEGAL RIGHTS, AND YOU MAY ALSO HAVE OTHER LEGAL RIGHTS WHICH VARY FROM STATE TO STATE AND COUNTRY TO COUNTRY.

## Outboard Limited Warranty (Confederation of Independent States, Middle-East, and Africa)

**WHAT IS COVERED:** Mercury Marine warrants its new Outboard and Jet Products to be free of defects in material and workmanship during the period described below.

**DURATION OF COVERAGE:** This Limited Warranty provides coverage for one (1) year from the date the product is first sold to a recreational use retail purchaser, or the date on which the product is first put into service, whichever occurs first. Commercial users of these products receive warranty coverage of one (1) year from the date of first retail sale, or one (1) year from the date on which the product was first put into service, whichever occurs first. Commercial use is defined as any work or employment related use of the product, or any use of the product which generates income, for any part of the warranty period, even if the product is only occasionally used for such purposes. The repair or replacement of parts, or the performance of service under this warranty, does not extend the life of this warranty beyond its original expiration date.

Unexpired warranty coverage can be transferred from one recreational use customer to a subsequent recreational use customer upon proper reregistration of the product. Unexpired warranty coverage cannot be transferred either to or from a commercial use customer.

### **CONDITIONS THAT MUST BE MET IN ORDER TO OBTAIN WARRANTY**

**COVERAGE:** Warranty coverage is available only to retail customers that purchase from a Dealer authorized by Mercury Marine to distribute the product in the country in which the sale occurred, and then only after the Mercury Marine specified predelivery inspection process is completed and documented. Warranty coverage becomes available upon proper registration of the product by the authorized dealer. Routine maintenance outlined in the Operation and Maintenance Manual must be timely performed in order to maintain warranty coverage. Mercury Marine reserves the right to make warranty coverage contingent on proof of proper maintenance.

# WARRANTY INFORMATION

**WHAT MERCURY WILL DO:** Mercury's sole and exclusive obligation under this warranty is limited to, at our option, repairing a defective part, replacing such part or parts with new or Mercury Marine certified remanufactured parts, or refunding the purchase price of the Mercury product. Mercury reserves the right to improve or modify products from time to time without assuming an obligation to modify products previously manufactured.

**HOW TO OBTAIN WARRANTY COVERAGE:** The customer must provide Mercury with a reasonable opportunity to repair, and reasonable access to the product for warranty service. Warranty claims shall be made by delivering the product for inspection to a Mercury dealer authorized to service the product. If purchaser cannot deliver the product to such a dealer, written notice must be given to Mercury. We will then arrange for the inspection and any covered repair. Purchaser, in that case, shall pay for all related transportation charges and/or travel time. If the service provided is not covered by this warranty, purchaser shall pay for all related labor and material, and any other expenses associated with that service. Purchaser shall not, unless requested by Mercury, ship the product or parts of the product directly to Mercury. Proof of registered ownership must be presented to the dealer at the time warranty service is requested in order to obtain coverage.

**WHAT IS NOT COVERED:** This limited warranty does not cover routine maintenance items, tune ups, adjustments, normal wear and tear, faded paint, damage caused by abuse, abnormal use, use of a propeller or gear ratio that does not allow the engine to run in its recommended wide-open throttle RPM range (see the Operation and Maintenance Manual), operation of the product in a manner inconsistent with the recommended operation/duty cycle section of the Operation and Maintenance Manual, neglect, accident, submersion, improper installation (proper installation specifications and techniques are set forth in the installation instructions for the product), improper service, use of an accessory or part not manufactured or sold by us, jet pump impellers and liners, operation with fuels, oils, or lubricants which are not suitable for use with the product (see the Operation and Maintenance Manual), alteration or removal of parts, or water entering the engine through the fuel intake, air intake, or exhaust system, or damage to the product from insufficient cooling water caused by blockage of the cooling system by foreign body, running the engine out of water, mounting the engine too high on the transom, or running the boat with the engine trimmed out too far.

Use of the product for racing or other competitive activity, or operating with a racing type lower unit, at any point, even by a prior owner of the product, voids the warranty.

Expenses related to haul-out, launch, towing, storage, telephone, rental, inconvenience, slip fees, insurance coverage, loan payments, loss of time, loss of income, or any other type of incidental or consequential damages are not covered by this warranty. Also, expenses associated with the removal and/or replacement of boat partitions or material caused by boat design for access to the product are not covered by this warranty.

# WARRANTY INFORMATION

No individual or entity, including Mercury Marine authorized dealers, has been given authority by Mercury Marine to make any affirmation, representation, or warranty regarding the product, other than those contained in this limited warranty, and if made, shall not be enforceable against Mercury Marine.

For additional information regarding events and circumstances covered by this warranty, and those that are not, see the Warranty Coverage section of the Operation and Maintenance Manual, incorporated by reference into this warranty.

## DISCLAIMERS AND LIMITATIONS:

**THE IMPLIED WARRANTIES OF MERCHANTABILITY AND FITNESS FOR A PARTICULAR PURPOSE ARE EXPRESSLY DISCLAIMED. TO THE EXTENT THAT THEY CANNOT BE DISCLAIMED, THE IMPLIED WARRANTIES ARE LIMITED IN DURATION TO THE LIFE OF THE EXPRESS WARRANTY. INCIDENTAL AND CONSEQUENTIAL DAMAGES ARE EXCLUDED FROM COVERAGE UNDER THIS WARRANTY. SOME STATES/COUNTRIES DO NOT ALLOW FOR THE DISCLAIMERS, LIMITATIONS AND EXCLUSIONS IDENTIFIED ABOVE, AS A RESULT, THEY MAY NOT APPLY TO YOU. THIS WARRANTY GIVES YOU SPECIFIC LEGAL RIGHTS, AND YOU MAY ALSO HAVE OTHER LEGAL RIGHTS WHICH VARY FROM STATE TO STATE AND COUNTRY TO COUNTRY.**

## 3 Year Limited Warranty Against Corrosion

**WHAT IS COVERED:** Mercury Marine warrants that each new Mercury, Mariner, Mercury Racing, Sport-Jet, M<sup>2</sup> Jet Drive, Tracker by Mercury Marine Outboard, Mercury MerCruiser Inboard or Sterndrive Engine (Product) will not be rendered inoperative as a direct result of corrosion for the period of time described below.

**DURATION OF COVERAGE:** This limited corrosion warranty provides coverage for three (3) years from either the date the product is first sold, or the date on which the product is first put into service, whichever occurs first. The repair or replacement of parts, or the performance of service under this warranty, does not extend the life of this warranty beyond its original expiration date. Unexpired warranty coverage can be transferred to subsequent (noncommercial use) purchaser upon proper reregistration of the product.

# WARRANTY INFORMATION

## **CONDITIONS THAT MUST BE MET IN ORDER TO OBTAIN WARRANTY**

**COVERAGE:** Warranty coverage is available only to retail customers that purchase from a Dealer authorized by Mercury Marine to distribute the product in the country in which the sale occurred, and then only after the Mercury Marine specified predelivery inspection process is completed and documented. Warranty coverage becomes available upon proper registration of the product by the authorized dealer. Corrosion prevention devices specified in the Operation and Maintenance Manual must be in use on the boat, and routine maintenance outlined in the Operation and Maintenance Manual must be timely performed (including, without limitation, the replacement of sacrificial anodes, use of specified lubricants, and touch-up of nicks and scratches) in order to maintain warranty coverage. Mercury Marine reserves the right to make warranty coverage contingent upon proof of proper maintenance.

**WHAT MERCURY WILL DO:** Mercury's sole and exclusive obligation under this warranty is limited to, at our option, repairing a corroded part, replacing such part or parts with new or Mercury Marine certified remanufactured parts, or refunding the purchase price of the Mercury product. Mercury reserves the right to improve or modify products from time to time without assuming an obligation to modify products previously manufactured.

**HOW TO OBTAIN WARRANTY COVERAGE:** The customer must provide Mercury with a reasonable opportunity to repair, and reasonable access to the product for warranty service. Warranty claims shall be made by delivering the product for inspection to a Mercury dealer authorized to service the product. If purchaser cannot deliver the product to such a dealer, written notice must be given to Mercury. We will then arrange for the inspection and any covered repair. Purchaser, in that case, shall pay for all related transportation charges and/or travel time. If the service provided is not covered by this warranty, purchaser shall pay for all related labor and material, and any other expenses associated with that service. Purchaser shall not, unless requested by Mercury, ship the product or parts of the product directly to Mercury. Proof of registered ownership must be presented to the dealer at the time warranty service is requested in order to obtain coverage.

**WHAT IS NOT COVERED:** This limited warranty does not cover electrical system corrosion; corrosion resulting from damage, corrosion which causes purely cosmetic damage, abuse, or improper service; corrosion to accessories, instruments, steering systems; corrosion to factory installed jet drive unit; damage due to marine growth; product sold with less than a one year limited Product warranty; replacement parts (parts purchased by customer); products used in a commercial application. Commercial use is defined as any work or employment related use of the product, or any use of the product which generates income, for any part of the warranty period, even if the product is only occasionally used for such purposes.



# WARRANTY INFORMATION

Corrosion damage caused by stray electrical currents (onshore power connections, nearby boats, submerged metal) is not covered by this corrosion warranty and should be protected against by the use of a corrosion protection system, such as the Mercury Precision Parts or Quicksilver MerCathode system and/or Galvanic Isolator. Corrosion damage caused by improper application of copper base antifouling paints is also not covered by this limited warranty. If antifouling protection is required, Tri-Butyl-Tin-Adipate (TBTA) base antifouling paints are recommended on Outboard and MerCruiser boating applications. In areas where TBTA base paints are prohibited by law, copper base paints can be used on the hull and transom. Do not apply paint to the outboard or MerCruiser product. In addition, care must be taken to avoid an electrical interconnection between the warranted product and the paint. For MerCruiser product, an unpainted gap of at least 38 mm (1.5 in.) should be left around the transom assembly. Refer to the Operation and Maintenance Manual for additional details.

For additional information regarding events and circumstances covered by this warranty, and those that are not, see the Warranty Coverage section of the Operation and Maintenance Manual, incorporated by reference into this warranty.

## **DISCLAIMERS AND LIMITATIONS:**

**THE IMPLIED WARRANTIES OF MERCHANTABILITY AND FITNESS FOR A PARTICULAR PURPOSE ARE EXPRESSLY DISCLAIMED. TO THE EXTENT THAT THEY CANNOT BE DISCLAIMED, THE IMPLIED WARRANTIES ARE LIMITED IN DURATION TO THE LIFE OF THE EXPRESS WARRANTY. INCIDENTAL AND CONSEQUENTIAL DAMAGES ARE EXCLUDED FROM COVERAGE UNDER THIS WARRANTY. SOME STATES/COUNTRIES DO NOT ALLOW FOR THE DISCLAIMERS, LIMITATIONS AND EXCLUSIONS IDENTIFIED ABOVE, AS A RESULT, THEY MAY NOT APPLY TO YOU. THIS WARRANTY GIVES YOU SPECIFIC LEGAL RIGHTS, AND YOU MAY ALSO HAVE OTHER LEGAL RIGHTS WHICH VARY FROM STATE TO STATE AND COUNTRY TO COUNTRY.**

## **Warranty Coverage and Exclusions**

The purpose of this section is to help eliminate some of the more common misunderstandings regarding warranty coverage. The following information explains some of the types of services that are not covered by warranty. The provisions set forth following have been incorporated by reference into the Three Year Limited Warranty Against Corrosion Failure, the International Limited Outboard Warranty, and the United States and Canada Limited Outboard Warranty.

Keep in mind that warranty covers repairs that are needed within the warranty period because of defects in material and workmanship. Installation errors, accidents, normal wear, and a variety of other causes that affect the product are not covered.

# WARRANTY INFORMATION

Warranty is limited to defects in material or workmanship, but only when the consumer sale is made in the country to which distribution is authorized by us. Should you have any questions concerning warranty coverage, contact your authorized dealer. They will be pleased to answer any questions that you may have.

## GENERAL EXCLUSIONS FROM WARRANTY

1. Minor adjustments and tune-ups, including checking, cleaning, or adjusting spark plugs, ignition components, carburetor settings, filters, belts, controls, and checking lubrication made in connection with normal services.
2. Installation errors, accidents, normal wear and tear, and faded paint.
3. Factory installed jet drive units - Specific parts excluded from the warranty are: the jet drive impeller and jet drive liner damaged by impact or wear, and water damaged driveshaft bearings as a result of improper maintenance.
4. Damage caused by neglect, lack of maintenance, accident, abnormal operation, or improper installation or service.
5. Haul-out, launch, towing charges, removal and/or replacement of boat partitions or material because of boat design for necessary access to the product, all related transportation charges and/or travel time, etc. Reasonable access must be provided to the product for warranty service. Customer must deliver product to an authorized dealer.
6. Additional service work requested by customer other than that necessary to satisfy the warranty obligation.
7. Labor performed by other than an authorized dealer may be covered only under the following circumstances: when performed on emergency basis (providing there are no authorized dealers in the area who can perform the work required or have no facilities to haul-out, etc.), and prior factory approval has been given to have the work performed at this facility).
8. All incidental and/or consequential damages (storage charges, telephone or rental charges of any type, inconvenience or loss of time or income) are the owner's responsibility.
9. Use of other than Mercury Precision or Quicksilver parts when making warranty repairs.
10. Oils, lubricants, or fluids changed as a matter of normal maintenance is customer's responsibility unless loss or contamination of same is caused by product failure that would be eligible for warranty consideration.
11. Participating in or preparing for racing or other competitive activity or operating with a racing type lower unit.
12. Engine noise does not necessarily indicate a serious engine problem. If diagnosis indicates a serious internal engine condition which could result in a failure, condition responsible for noise should be corrected under the warranty.

# WARRANTY INFORMATION

13. Lower unit and/or propeller damage caused by striking a submerged object is considered a marine hazard.
14. Water entering engine through the fuel intake, air intake, or exhaust system or submersion.
15. Failure of any parts caused by lack of cooling water, which results from starting motor out of water, foreign material blocking inlet holes, motor being mounted too high, or trimmed too far out.
16. Use of fuels and lubricants which are not suitable for use with or on the product. Refer to the **Maintenance** section.
17. Our limited warranty does not apply to any damage to our products caused by the installation or use of parts and accessories which are not manufactured or sold by us. Failures which are not related to the use of those parts or accessories are covered under warranty if they otherwise meet the terms of the limited warranty for that product.

## Warranty Policy—Australia and New Zealand

### MERCURY/MARINER OUTBOARD LIMITED WARRANTY—AUSTRALIA AND NEW ZEALAND POLICY

This limited warranty is given by Marine Power International Pty Ltd ACN 003 100 007 of 41–71 Bessemer Drive, Dandenong South, Victoria 3175 Australia (telephone (61) (3) 9791 5822) e-mail: [merc\\_info@mercmarine.com](mailto:merc_info@mercmarine.com).

#### What is Covered

Mercury Marine warrants its new products to be free of defects in material and workmanship during the period described following. The benefits to the consumer given by the warranty are in addition to other rights and remedies of the consumer under a law in relation to the goods or services to which the warranty relates.

#### Guarantees Under Australian Consumer Law

Our goods come with guarantees that cannot be excluded under the Australian Consumer Law. You are entitled to a replacement or refund for a major failure and compensation for any other reasonably foreseeable loss or damage. You are also entitled to have the goods repaired or replaced if the goods fail to be of acceptable quality and the failure does not amount to a major failure.

#### Warranty Period for Recreational Use

This Limited Warranty provides coverage for three (3) years from the date the product is first sold to a recreational use retail purchaser, or the date on which the product is first put into service, whichever occurs first. Unexpired warranty coverage can be transferred to a subsequent recreational use customer upon proper registration of the product.

# WARRANTY INFORMATION

## **Warranty Period for Commercial Use**

Commercial users of these products receive warranty coverage under this Limited Warranty of one (1) year from the date of first retail sale, or one (1) year from the date on which the product was first put into service, whichever occurs first. Commercial use is defined as any work or employment related use of the product, or any use of the product which generates income, for any part of the warranty period, even if the product is only occasionally used for such purposes. Unexpired warranty coverage cannot be transferred either to or from a commercial use customer.

## **Conditions That Must Be Met to Obtain Warranty Coverage**

Warranty coverage under this Limited Warranty is available only to retail customers that purchase from a Dealer authorized by Mercury Marine to distribute the product in the country in which the sale occurred, and then only after the Mercury Marine specified predelivery inspection process is completed and documented. Warranty coverage becomes available upon proper registration of the product by the authorized dealer. Inaccurate warranty registration information regarding recreational use, or subsequent change of use from recreational to commercial (unless properly registered) may void the warranty at the sole discretion of Mercury Marine. Routine maintenance outlined in the Operation and Maintenance Manual must be timely performed in order to maintain warranty coverage. Mercury Marine reserves the right to make warranty coverage contingent upon proof of proper maintenance.

## **What Mercury Will Do**

Mercury Marine's sole and exclusive obligation under this Limited Warranty is limited to, at our option, repairing a defective part, replacing such part or parts with new or Mercury Marine certified remanufactured parts, or refunding the purchase price of the Mercury Marine product. Mercury Marine reserves the right to improve or modify products from time to time without assuming an obligation to modify products previously manufactured.

# WARRANTY INFORMATION

## How to Obtain Warranty Coverage Under This Limited Warranty

The customer must provide Mercury Marine with a reasonable opportunity to repair and reasonable access to the product for warranty service. Warranty claims shall be made by delivering the product for inspection to a Mercury Marine dealer authorized to service the product. A list of dealers and their contact details is available at [www.mercurymarine.com.au](http://www.mercurymarine.com.au). If the purchaser cannot deliver the product to such a dealer, written notice must be given to Mercury Marine at the address shown above. Mercury Marine will then arrange for the inspection and any covered repair. This Limited Warranty will not cover the purchaser for all related transportation charges and travel time. If the service provided is not covered by this limited warranty, the purchaser shall pay for all related labor and material and any other expenses associated with that service, provided that a consumer will not be obligated to pay where the service has been carried out to remedy a failure of an acceptable quality guarantee which is binding on Mercury Marine under the Australian Consumer Law. The purchaser shall not, unless requested by Mercury Marine, ship the product or parts of the product directly to Mercury Marine. Proof of registered ownership must be presented to the dealer at the time warranty service is requested in order to obtain coverage under this Limited Warranty.

## What is Not Covered

This limited warranty does not cover routine maintenance items, tune-ups, adjustments, normal wear and tear, faded paint, damage caused by abuse, abnormal use, use of a propeller or gear ratio that does not allow the engine to run in its recommended wide-open throttle RPM range (see the Operation and Maintenance Manual), operation of the product in a manner inconsistent with the recommended operation/duty cycle section of the Operation and Maintenance Manual, neglect, accident, submersion, improper installation (proper installation specifications and techniques are set forth in the installation instructions for the product), improper service, use of an accessory or part not manufactured or sold by us, jet pump impellers and liners, operation with fuels, oils or lubricants that are not suitable for use with the product (see the Operation and Maintenance Manual), alteration or removal of parts, water entering the engine through the fuel intake, air intake or exhaust system, or damage to the product from insufficient cooling water caused by blockage of the cooling system by a foreign body, running the engine out of water, mounting the engine too high on the transom, or running the boat with the engine trimmed out too far. Use of the product for racing or other competitive activity, or operating with a racing type lower unit, at any point, even by a prior owner of the product, voids the warranty.

Expenses related to haul-out, launch, towing, storage, telephone, rental, inconvenience, slip fees, insurance coverage, loan payments, loss of time, loss of income, or any other type of incidental or consequential damages are not covered by this Limited Warranty. Also, expenses associated with the removal and/or replacement of boat partitions or material caused by boat design for access to the product are not covered by this warranty.

# WARRANTY INFORMATION

No individual or entity, including Mercury Marine authorized dealers, has been given authority by Mercury Marine to make any affirmation, representation or warranty regarding the product, other than those contained in this limited warranty, and if made, shall not be enforceable against Mercury Marine. For additional information regarding events and circumstances covered by this warranty, and those that are not, see the Warranty Coverage section of the Operation and Maintenance Manual, incorporated by reference into this warranty.

## **Expense of Claiming This Limited Warranty**

This Limited Warranty does not cover any expenses you may incur claiming the warranty.

<b>DISCLAIMERS AND LIMITATIONS:</b>
<b>EXCEPT FOR APPLICABLE GUARANTEES AND OTHER RIGHTS AND REMEDIES THAT A CONSUMER MAY HAVE UNDER THE AUSTRALIAN CONSUMER LAW OR OTHER LAW IN RELATION TO WHICH THE PRODUCTS RELATE, THE IMPLIED WARRANTIES OF MERCHANTABILITY AND FITNESS FOR A PARTICULAR PURPOSE ARE EXPRESSLY DISCLAIMED. TO THE EXTENT THAT THEY CANNOT BE DISCLAIMED, THE IMPLIED WARRANTIES ARE LIMITED IN DURATION TO THE LIFE OF THE EXPRESS WARRANTY. INCIDENTAL AND CONSEQUENTIAL DAMAGES ARE EXCLUDED FROM COVERAGE UNDER THIS LIMITED WARRANTY.</b>

## **TRANSFER OF WARRANTY—AUSTRALIA AND NEW ZEALAND POLICY**

The limited warranty is transferable to a subsequent purchaser, but only for the remainder of the unused portion of the limited warranty. This will not apply to products used for commercial applications.

To transfer the warranty to the subsequent owner, send or fax a copy of the Bill of Sale or Purchase Agreement, new owner's name, address, and hull identification number (HIN) to Mercury Marine's Warranty Registration Department. In Australia and New Zealand, mail to:

Mercury Marine  
Attn: Warranty Registration Department  
Brunswick Asia Pacific Group  
Private Bag 1420  
Dandenong South, Victoria 3164  
Australia

Upon processing the transfer of warranty, Mercury Marine will send registration verification to the new owner of the product by mail. There is no charge for this service.

# WARRANTY INFORMATION

You may change your address at any time, including at the time of the warranty claim, by calling Mercury Marine or sending a letter or fax with your name, old address, new address, and hull identification number (HIN) to Mercury Marine's Warranty Registration Department.

## Global Warranty Charts Outboard and Jets

### CANADA WARRANTY CHARTS—OUTBOARD AND JET

Product	Standard Limited Warranty	Standard Limited Corrosion Warranty
2-Stroke carbureted (50–90 hp)	1 year	3 years
2-Stroke EFI (150 hp)	2 years	3 years
2-Stroke carbureted (V6)	2 years	3 years
FourStroke (2.5–300 hp including Verado, Pro FourStroke and Jet outboards)	3 years	3 years
OptiMax (75–250 hp including Pro XS and Jet outboards)	3 years	3 years
OptiMax Jet drive (200 and 250 hp)	1 year	3 years

Racing Product (Recreation use only)	Standard Limited Warranty	Standard Limited Corrosion Warranty
OptiMax (250 XS)	2 years	3 years
OptiMax (300 XS)	2 years	3 years
Verado (350 SCi)	2 years	3 years

### Outside of Canada

For product purchased outside of Canada, contact the distributor in your country, or the authorized Marine Power Service Center or dealer closest to you.

# WARRANTY INFORMATION

## AUSTRALIA AND NEW ZEALAND WARRANTY CHARTS—OUTBOARD AND JET

Products	Standard Limited Warranty	Standard Limited Corrosion Warranty	Light Commercial
All outboard	3 years	3 years	Contact the Marine Power Service Center closest to you

### Outside of Australia and New Zealand

For product purchased outside of Australia and New Zealand, contact the distributor in your country, or the Marine Power Service Center closest to you.

## SOUTH PACIFIC WARRANTY CHART—OUTBOARD AND JET

Products	Standard Limited Warranty	Standard Limited Corrosion Warranty	Light Commercial
All outboard	2 years	3 years	Contact the Marine Power Service Center closest to you

### Outside of South Pacific

For product purchased outside of the South Pacific region, contact the distributor in your country, or the Marine Power Service Center closest to you.

## ASIA WARRANTY CHARTS—OUTBOARD AND JET

Product (Recreational only)	Standard Limited Warranty	Standard Limited Corrosion Warranty	Commercial Application
2-Stroke	1 year	3 years	Contact the Marine Power Service Center closest to you
FourStroke	1 year	3 years	
OptiMax	1 year	3 years	
Verado	1 year	3 years	



# WARRANTY INFORMATION

<b>Racing Product (Recreational only)</b>	<b>Standard Limited Warranty</b>	<b>Standard Limited Corrosion Warranty</b>	<b>Commercial Application</b>
Verado 350 SCi	1 year	3 years	None

## Outside of Asia

For product purchased outside of the Asian region, contact the distributor in your country, or the Marine Power Service Center closest to you.

## EUROPE AND THE CONFEDERATION OF INDEPENDENT STATES (CIS) WARRANTY CHARTS—OUTBOARD AND JET

<b>Product (Recreational only)</b>	<b>Standard Limited Warranty</b>	<b>Standard Limited Corrosion Warranty</b>	<b>Commercial Application</b>
2-Stroke	2 years	3 years	Contact the Marine Power Service Center closest to you
FourStroke	2 years	3 years	
OptiMax (including Pro XS)	3 years	3 years	
Verado (including Pro)	3 years	3 years	

<b>Racing Product (Recreational only)</b>	<b>Standard Limited Warranty</b>	<b>Standard Limited Corrosion Warranty</b>	<b>Commercial Application</b>
Verado 350 SCi	2 years	3 years	Contact the Marine Power Service Center closest to you

## Outside Europe and CIS

For products purchased outside of Europe and CIS regions, contact the distributor in your country, or the Marine Power Service Center closest to you.

# WARRANTY INFORMATION

## MIDDLE-EAST AND AFRICA (EXCLUDING SOUTH AFRICA) WARRANTY CHARTS–OUTBOARD AND JET

Product (Recreational only)	Standard Limited Warranty	Standard Limited Corrosion Warranty	Commercial Application
2-Stroke	1 year	3 years	Contact the Marine Power Service Center closest to you
FourStroke	2 years	3 years	
OptiMax (including Pro XS)	3 years	3 years	
Verado (including Pro)	3 years	3 years	

Racing Product (Recreational only)	Standard Limited Warranty	Standard Limited Corrosion Warranty
Verado 350 SCi	2 years	3 years

### Outside Middle-East and Africa

For products purchased outside of the Middle-East and Africa regions, contact the distributor in your country, or the Marine Power Service Center closest to you.

## SOUTH AFRICA WARRANTY CHARTS–OUTBOARD AND JET

Product (Recreational only)	Standard Limited Warranty	Standard Limited Corrosion Warranty	Commercial Application
2-Stroke	2 years	3 years	Contact the Marine Power Service Center closest to you
FourStroke	2 years	3 years	
OptiMax (including Pro XS)	3 years	3 years	
Verado (including Pro)	3 years	3 years	

Racing Product (Recreational only)	Standard Limited Warranty	Standard Limited Corrosion Warranty
Verado 350 SCi	2 years	3 years

# WARRANTY INFORMATION

## **Outside South Africa**

For products purchased outside of the South Africa region, contact the distributor in your country, or the Marine Power Service Center closest to you.

# GENERAL INFORMATION

## Boater's Responsibilities

The operator (driver) is responsible for the correct and safe operation of the boat and the safety of its occupants and general public. It is strongly recommended that each operator read and understand this entire manual before operating the outboard.

Be sure that at least one additional person onboard is instructed in the basics of starting and operating the outboard and boat handling in case the driver is unable to operate the boat.

## Before Operating Your Outboard

Read this manual carefully. Learn how to operate your outboard properly. If you have any questions, contact your dealer.

Safety and operating information that is practiced, along with using good common sense, can help prevent personal injury and product damage.

This manual as well as safety labels posted on the outboard use the following safety alerts to draw your attention to special safety instructions that should be followed.

### DANGER

Indicates a hazardous situation which, if not avoided, will result in death or serious injury.

### WARNING

Indicates a hazardous situation which, if not avoided, could result in death or serious injury.

### CAUTION

Indicates a hazardous situation which, if not avoided, could result in minor or moderate injury.

### NOTICE

Indicates a situation which, if not avoided, could result in engine or major component failure.

## Boat Horsepower Capacity

### WARNING

Exceeding the boat's maximum horsepower rating can cause serious injury or death. Overpowering the boat can affect boat control and flotation characteristics or break the transom. Do not install an engine that exceeds the boat's maximum power rating.

# GENERAL INFORMATION

Do not overpower or overload your boat. Most boats will carry a required capacity plate indicating the maximum acceptable power and load as determined by the manufacturer following certain federal guidelines. If in doubt, contact your dealer or the boat manufacturer.

U.S. COAST GUARD CAPACITY	
MAXIMUM HORSEPOWER	XXX
MAXIMUM PERSON CAPACITY (POUNDS)	XXX
MAXIMUM WEIGHT CAPACITY	XXX

26777

## High-Speed and High-Performance Boat Operation

If your outboard is to be used on a high-speed or high-performance boat with which you are unfamiliar, we recommend that you do not operate it at its high speed capability without first requesting an initial orientation and familiarization demonstration ride with your dealer or an operator experienced with your boat/outboard combination. For additional information, obtain a copy of our

**Hi-Performance Boat Operation** booklet from your dealer, distributor, or Mercury Marine.

## Outboard Remote Control Models

The remote control connected to your outboard must be equipped with a start in neutral only protection device. This prevents the engine from starting when the shift is actuated in any position other than neutral.

### ▲ WARNING

**Starting the engine with the drive in gear can cause serious injury or death. Never operate a boat that does not have a neutral-safety-protection device.**

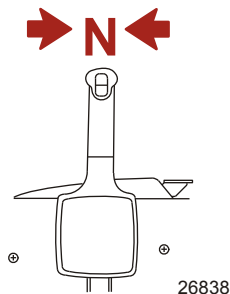

# GENERAL INFORMATION

## Remote Steering Notice

### **⚠ WARNING**

Improper fasteners or improper installation procedures can result in loosening or disengagement of the steering link rod. This can cause a sudden, unexpected loss of boat control, resulting in serious injury or death due to occupants being thrown within or out of the boat. Always use required components and follow instructions and torque procedures.

The steering link rod that connects the steering cable to the engine must be fastened utilizing self-locking nuts. These self-locking nuts must never be replaced with common nuts (non-locking) as they will work loose and vibrate off, freeing the link rod to disengage.

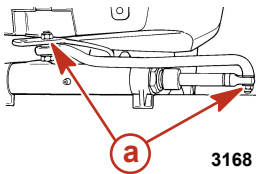

**a** - Self-locking nuts

3168

## Lanyard Stop Switch

The purpose of a lanyard stop switch is to turn off the engine when the operator moves far enough away from the operator's position (as in accidental ejection from the operator's position) to activate the switch. Tiller handle outboards and some remote control units are equipped with a lanyard stop switch. A lanyard stop switch can be installed as an accessory - generally on the dashboard or side adjacent to the operator's position.

A decal near the lanyard stop switch is a visual reminder for the operator to attach the lanyard to their personal flotation device (PFD) or wrist.

# GENERAL INFORMATION

The lanyard cord is usually 122–152 cm (4–5 feet) in length when stretched out, with an element on one end made to be inserted into the switch and a clip on the other end for attaching to the operator's PFD or wrist. The lanyard is coiled to make its at-rest condition as short as possible to minimize the likelihood of lanyard entanglement with nearby objects. Its stretched-out length is made to minimize the likelihood of accidental activation should the operator choose to move around in an area close to the normal operator's position. If it is desired to have a shorter lanyard, wrap the lanyard around the operator's wrist or leg, or tie a knot in the lanyard.

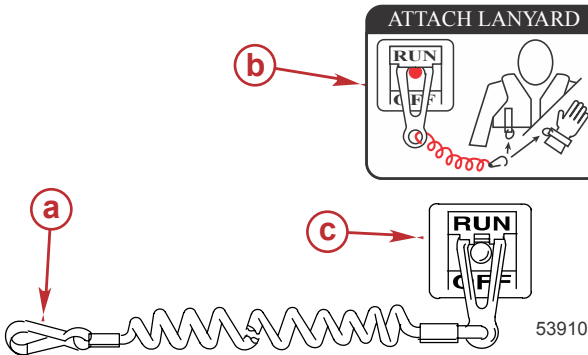

- a - Lanyard cord clip
- b - Lanyard decal
- c - Lanyard stop switch

Read the following Safety Information before proceeding.

**Important Safety Information:** The purpose of a lanyard stop switch is to stop the engine when the operator moves far enough away from the operator's position to activate the switch. This would occur if the operator accidentally falls overboard or moves within the boat a sufficient distance from the operator's position. Falling overboard and accidental ejections are more likely to occur in certain types of boats such as low sided inflatables, bass boats, high performance boats, and light, sensitive handling fishing boats operated by a hand tiller. Falling overboard and accidental ejections are also likely to occur as a result of poor operating practices such as sitting on the back of the seat or gunwale at planing speeds, standing at planing speeds, sitting on elevated fishing boat decks, operating at planing speeds in shallow or obstacle infested waters, releasing your grip on a steering wheel or tiller handle that is pulling in one direction, drinking alcohol or consuming drugs, or daring high speed boat maneuvers.

While activation of the lanyard stop switch will stop the engine immediately, a boat will continue to coast for some distance depending upon the velocity and degree of any turn at shut down. However, the boat will not complete a full circle. While the boat is coasting, it can cause injury to anyone in the boat's path as seriously as the boat would when under power.

# GENERAL INFORMATION

We strongly recommend that other occupants be instructed on proper starting and operating procedures should they be required to operate the engine in an emergency (if the operator is accidentally ejected).

## **▲ WARNING**

**If the operator falls out of the boat, stop the engine immediately to reduce the possibility of serious injury or death from being struck by the boat. Always properly connect the operator to the stop switch using a lanyard.**

## **▲ WARNING**

**Avoid serious injury or death from deceleration forces resulting from accidental or unintended stop switch activation. The boat operator should never leave the operator's station without first disconnecting the stop switch lanyard from the operator.**

Accidental or unintended activation of the switch during normal operation is also a possibility. This could cause any, or all, of the following potentially hazardous situations:

- Occupants could be thrown forward due to unexpected loss of forward motion - a particular concern for passengers in the front of the boat who could be ejected over the bow and possibly struck by the gearcase or propeller.
- Loss of power and directional control in heavy seas, strong current, or high winds.
- Loss of control when docking.

## **KEEP THE LANYARD STOP SWITCH AND LANYARD CORD IN GOOD OPERATING CONDITION**

Before each use, check to ensure the lanyard stop switch works properly. Start the engine and stop it by pulling the lanyard cord. If the engine does not stop, have the switch repaired before operating the boat.

Before each use, visually inspect the lanyard cord to ensure it is in good working condition and that there are no breaks, cuts, or wear to the cord. Check that the clips on the ends of the cord are in good condition. Replace any damaged or worn lanyard cords.



# GENERAL INFORMATION

## Protecting People in the Water

### WHILE YOU ARE CRUISING

It is very difficult for a person standing or floating in the water to take quick action to avoid a boat heading in his/her direction, even at slow speed.



Always slow down and exercise extreme caution any time you are boating in an area where there might be people in the water.

Whenever a boat is moving (coasting) and the outboard gear shift is in neutral position, there is sufficient force by the water on the propeller to cause the propeller to rotate. This neutral propeller rotation can cause serious injury.

### WHILE THE BOAT IS STATIONARY

#### **▲ WARNING**

**A spinning propeller, a moving boat, or any solid device attached to the boat can cause serious injury or death to swimmers. Stop the engine immediately whenever anyone in the water is near your boat.**

Shift the outboard into neutral and shut off the engine before allowing people to swim or be in the water near your boat.

### Passenger Safety Message - Pontoon Boats and Deck Boats

Whenever the boat is in motion, observe the location of all passengers. Do not allow any passengers to stand or use seats other than those designated for traveling faster than idle speed. A sudden reduction in boat speed, such as plunging into a large wave or wake, a sudden throttle reduction, or a sharp change of boat direction, could throw them over the front of the boat. Falling over the front of the boat between the two pontoons will position them to be run over by the outboard.

### BOATS HAVING AN OPEN FRONT DECK

No one should ever be on the deck in front of the fence while the boat is in motion. Keep all passengers behind the front fence or enclosure.

# GENERAL INFORMATION

Persons on the front deck could easily be thrown overboard or persons dangling their feet over the front edge could get their legs caught by a wave and pulled into the water.

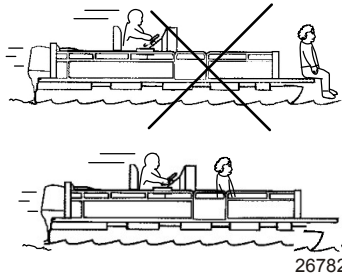

## ⚠ WARNING

Sitting or standing in an area of the boat not designed for passengers at speeds above idle can cause serious injury or death. Stay back from the front end of deck boats or raised platforms and remain seated while the boat is in motion.

### BOATS WITH FRONT MOUNTED, RAISED PEDESTAL FISHING SEATS

Elevated fishing seats are not intended for use when the boat is traveling faster than idle or trolling speed. Sit only in seats designated for traveling at faster speeds.

Any unexpected, sudden reduction in boat speed could result in the elevated passenger falling over the front of the boat.

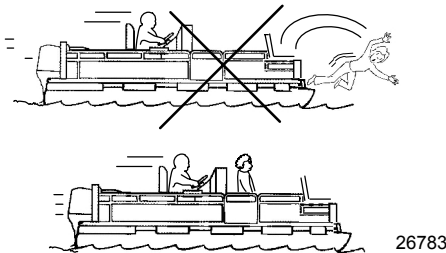

# GENERAL INFORMATION

## Wave and Wake Jumping

Operating recreational boats over waves and wake is a natural part of boating. However, when this activity is done with sufficient speed to force the boat hull partially or completely out of the water, certain hazards arise, particularly when the boat enters the water.

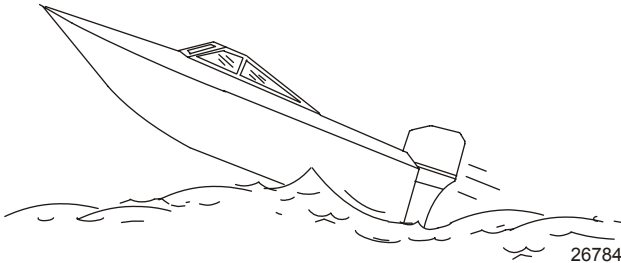

The primary concern is the boat changing direction while in the midst of the jump. In such case, the landing may cause the boat to veer violently in a new direction. Such a sharp change in direction can cause occupants to be thrown out of their seats, or out of the boat.

### **▲ WARNING**

**Wave or wake jumping can cause serious injury or death from occupants being thrown within or out of the boat. Avoid wave or wake jumping whenever possible.**

There is another less common hazardous result from allowing your boat to launch off a wave or wake. If the bow of your boat pitches down far enough while airborne, upon water contact it may penetrate under the water surface and submarine for an instant. This will bring the boat to a nearly instantaneous stop and can send the occupants flying forward. The boat may also steer sharply to one side.

# GENERAL INFORMATION

## Impact with Underwater Hazards

Reduce speed and proceed with caution whenever you drive a boat in shallow water areas, or in areas where you suspect underwater obstacles may exist which could be struck by the outboard or the boat bottom. **The most important thing you can do to help reduce injury or impact damage from striking a floating or underwater object is to control the boat speed. Under these conditions, boat speed should be kept to a minimum planing speed of 24 to 40 km/h (15 to 25 mph).**

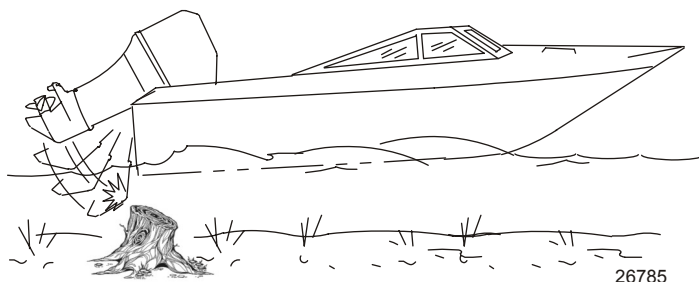

Striking a floating or underwater object could result in an infinite number of situations. Some of these situations could result in the following:

- Part of the outboard or the entire outboard could break loose and fly into the boat.
- The boat could move suddenly in a new direction. Such a sharp change in direction can cause occupants to be thrown out of their seats or out of the boat.
- A rapid reduction in speed. This will cause occupants to be thrown forward, or even out of the boat.
- Impact damage to the outboard and/or boat.

Keep in mind, the most important thing you can do to help reduce injury or impact damage during an impact is control the boat speed. Boat speed should be kept to a minimum planing speed when driving in waters known to have underwater obstacles.

After striking a submerged object, stop the engine as soon as possible and inspect it for any broken or loose parts. If damage is present or suspected, the outboard should be taken to an authorized dealer for a thorough inspection and necessary repair.

The boat should also be checked for any hull fractures, transom fractures, or water leaks.

Operating a damaged outboard could cause additional damage to other parts of the outboard, or could affect control of the boat. If continued running is necessary, do so at greatly reduced speeds.

# GENERAL INFORMATION

## **⚠ WARNING**

**Operating a boat or engine with impact damage can result in product damage, serious injury, or death. If the vessel experiences any form of impact, have an authorized Mercury Marine dealer inspect and repair the vessel or power package.**

## **Safety Instructions for Hand-Tilted Outboards**

No person or cargo should occupy the area directly in front of the outboard while the boat is in motion. If an underwater obstacle is struck, the outboard will tilt up and could seriously injure anyone occupying this area.

### **MODELS WITH CLAMP SCREWS:**

Some outboards come with transom bracket clamp screws. The use of clamp bracket screws alone, is insufficient to properly and safely secure the outboard to the transom. Proper installation of the outboard includes bolting the engine to the boat through the transom. Refer to **Installation - Installing Outboard** for more complete installation information.

## **⚠ WARNING**

**Failure to correctly fasten the outboard could result in the outboard propelling off the boat transom resulting in property damage, serious injury, or death. Before operation, the outboard must be correctly installed with the required mounting hardware.**

If an obstacle is struck at planing speed and the outboard is not securely fastened to the transom, it is possible the outboard could lift off the transom and land in the boat.

## **Exhaust Emissions**

### **BE ALERT TO CARBON MONOXIDE POISONING**

Carbon monoxide (CO) is a deadly gas that is present in the exhaust fumes of all internal combustion engines, including the engines that propel boats, and the generators that power boat accessories. By itself, CO is odorless, colorless, and tasteless, but if you can smell or taste engine exhaust, you are inhaling CO.

Early symptoms of carbon monoxide poisoning, which are similar to the symptoms of seasickness and intoxication, include headache, dizziness, drowsiness, and nausea.

# GENERAL INFORMATION

## ⚠ WARNING

Inhaling engine exhaust gases can result in carbon monoxide poisoning, which can lead to unconsciousness, brain damage, or death. Avoid exposure to carbon monoxide.

Stay clear from exhaust areas when engine is running. Keep the boat well-ventilated while at rest or underway.

## STAY CLEAR OF EXHAUST AREAS

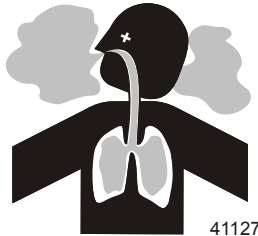

Engine exhaust gases contain harmful carbon monoxide. Avoid areas of concentrated engine exhaust gases. When engines are running, keep swimmers away from the boat, and do not sit, lie, or stand on swim platforms or boarding ladders. While underway, do not allow passengers to be positioned immediately behind the boat (platform dragging, teak/body surfing). This dangerous practice not only places a person in an area of high engine exhaust concentration, but also subjects them to the possibility of injury from the boat propeller.

## GOOD VENTILATION

Ventilate the passenger area, open side curtains or forward hatches to remove fumes.

Example of desired air flow through the boat:

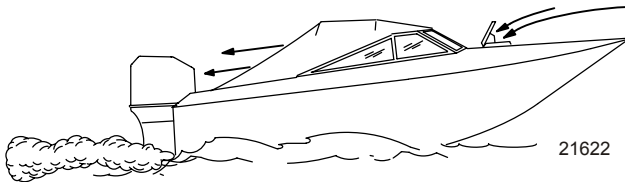

## POOR VENTILATION

Under certain running and/or wind conditions, permanently enclosed or canvas enclosed cabins or cockpits with insufficient ventilation may draw in carbon monoxide. Install one or more carbon monoxide detectors in your boat.

Although the occurrence is rare, on a very calm day, swimmers and passengers in an open area of a stationary boat that contains, or is near, a running engine may be exposed to a hazardous level of carbon monoxide.

# GENERAL INFORMATION

## 1. Examples of poor ventilation while the boat is stationary:

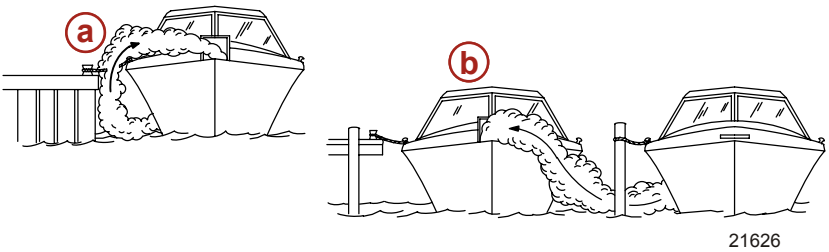

- a** - Operating the engine when the boat is moored in a confined space
- b** - Mooring close to another boat that has its engine operating

## 2. Examples of poor ventilation while the boat is moving:



- a** - Operating the boat with the trim angle of the bow too high
- b** - Operating the boat with no forward hatches open (station wagon effect)

## Selecting Accessories for Your Outboard

Genuine Mercury Precision or Quicksilver Accessories have been specifically designed and tested for your outboard. These accessories are available from Mercury Marine dealers.

**IMPORTANT: Check with your dealer before installing accessories. The misuse of approved accessories or the use of nonapproved accessories can damage the product.**

Some accessories not manufactured or sold by Mercury Marine are not designed to be safely used with your outboard or outboard operating system. Acquire and read the installation, operation and maintenance manuals for all your selected accessories.

## Safe Boating Recommendations

To safely enjoy the waterways, familiarize yourself with local and all other governmental boating regulations and restrictions and consider the following suggestions.

**Know and obey all nautical rules and laws of the waterways.**

# GENERAL INFORMATION

- We recommend that all powerboat operators complete a boating safety course. In the U.S., the U.S. Coast Guard Auxiliary, the Power Squadron, the Red Cross, and your state or provincial boating law enforcement agency provide courses. For more information in the U.S., call the Boat U.S. Foundation at 1-800-336-BOAT (2628).

## **Perform safety checks and required maintenance.**

- Follow a regular schedule and ensure that all repairs are properly made.

## **Check safety equipment onboard.**

- Here are some suggestions of the types of safety equipment to carry when boating:
  - Approved fire extinguishers
  - Signal devices: flashlight, rockets or flares, flag, and whistle or horn
  - Tools necessary for minor repairs
  - Anchor and extra anchor line
  - Manual bilge pump and extra drain plugs
  - Drinking water
  - Radio
  - Paddle or oar
  - Spare propeller, thrust hubs, and an appropriate wrench
  - First aid kit and instructions
  - Waterproof storage containers
  - Spare operating equipment, batteries, bulbs, and fuses
  - Compass and map or chart of the area
  - Personal flotation device (one per person onboard)

## **Watch for signs of weather change and avoid foul weather and rough-sea boating.**

## **Tell someone where you are going and when you expect to return.**

## **Passenger boarding.**

- Stop the engine whenever passengers are boarding, unloading, or are near the back (stern) of the boat. Shifting the drive unit into neutral is not sufficient.

## **Use personal flotation devices.**

- Federal law requires that there be a U.S. Coast Guard-approved life jacket (personal flotation device), correctly sized and readily accessible for every person onboard, plus a throwable cushion or ring. We strongly advise that everyone wear a life jacket at all times while in the boat.

## **Prepare other boat operators.**



# GENERAL INFORMATION

- Instruct at least one person onboard in the basics of starting and operating the engine and boat handling in case the driver becomes disabled or falls overboard.

## **Do not overload your boat.**

- Most boats are rated and certified for maximum load (weight) capacities (refer to your boat's capacity plate). Know your boat's operating and loading limitations. Know if your boat will float if it is full of water. When in doubt, contact your authorized Mercury Marine dealer or the boat manufacturer.

## **Ensure that everyone in the boat is properly seated.**

- Do not allow anyone to sit or ride on any part of the boat that was not intended for such use. This includes the backs of seats, gunwales, transom, bow, decks, raised fishing seats, and any rotating fishing seat. Passengers should not sit or ride anywhere that sudden unexpected acceleration, sudden stopping, unexpected loss of boat control, or sudden boat movement could cause a person to be thrown overboard or into the boat. Ensure that all passengers have a proper seat and are in it before any boat movement.

## **Never operate a boat while under the influence of alcohol or drugs. It is the law.**

- Alcohol or drugs can impair your judgment and greatly reduce your ability to react quickly.

## **Know your boating area and avoid hazardous locations.**

### **Be alert.**

- The operator of the boat is responsible by law to maintain a proper lookout by sight and hearing. The operator must have an unobstructed view particularly to the front. No passengers, load, or fishing seats should block the operator's view when the boat is above idle or planing transition speed. Watch out for others, the water, and your wake.

## **Never drive your boat directly behind a water skier.**

- Your boat traveling at 40 km/h (25 mph) will overtake a fallen skier who is 61 m (200 ft) in front of you in five seconds.

## **Watch fallen skiers.**

- When using your boat for waterskiing or similar activities, always keep a fallen or down skier on the operator's side of the boat while returning to attend to the skier. The operator should always have the down skier in sight and never back up to the skier or anyone in the water.

## **Report accidents.**

# GENERAL INFORMATION

- Boat operators are required by law to file a boating accident report with their state boating law enforcement agency when their boat is involved in certain boating accidents. A boating accident must be reported if 1) there is loss of life or probable loss of life, 2) there is personal injury requiring medical treatment beyond first aid, 3) there is damage to boats or other property where the damage value exceeds \$500.00, or 4) there is complete loss of the boat. Seek further assistance from local law enforcement.

## Recording Serial Number

It is important to record this number for future reference. The serial number is located on the outboard as shown.

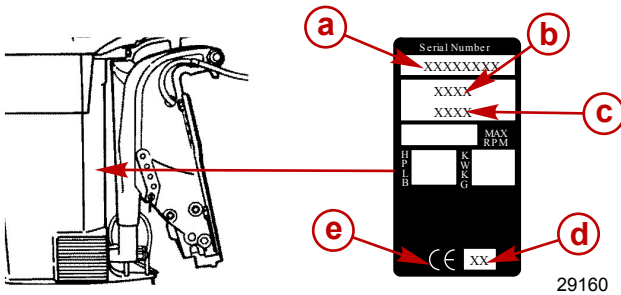

- a** - Serial number
- b** - Model year
- c** - Model designation
- d** - Year manufactured
- e** - Certified Europe Insignia (as applicable)

## 55/60 SeaPro/Marathon Specifications

Models	55	60
Horsepower	55	60
Kilowatts	41	44.7
Full throttle RPM range	5000–5500 RPM	
Idle speed in forward gear	650–700 RPM	
Number of cylinders	3	
Piston displacement	965 cc (58.9 cu. in.)	
Cylinder bore	76 mm (2.993 in.)	
Stroke	71 mm (2.796 in.)	
Recommended spark plug	NGK BPZ8H-N-10	

## GENERAL INFORMATION

<b>Models</b>		<b>55</b>	<b>60</b>
Spark plug gap		1.0 mm (0.040 in.)	
Gear ratio	Standard gearcase	1.64:1	
	Command Thrust gearcase	2.3:1	
Gearcase lubricant Capacity	Standard gearcase	340 ml (11.5 fl oz)	
	Command Thrust gearcase	666 ml (22.5 fl oz)	
Recommended gasoline		<b>Refer to Fuel and Oil</b>	
Recommended oil		<b>Refer to Fuel and Oil</b>	
Battery rating		465 marine cranking amps (MCA) or 350 cold cranking amps (CCA)	
Amp hours (Ah)		70–100	

# GENERAL INFORMATION

## 60 Component Identification

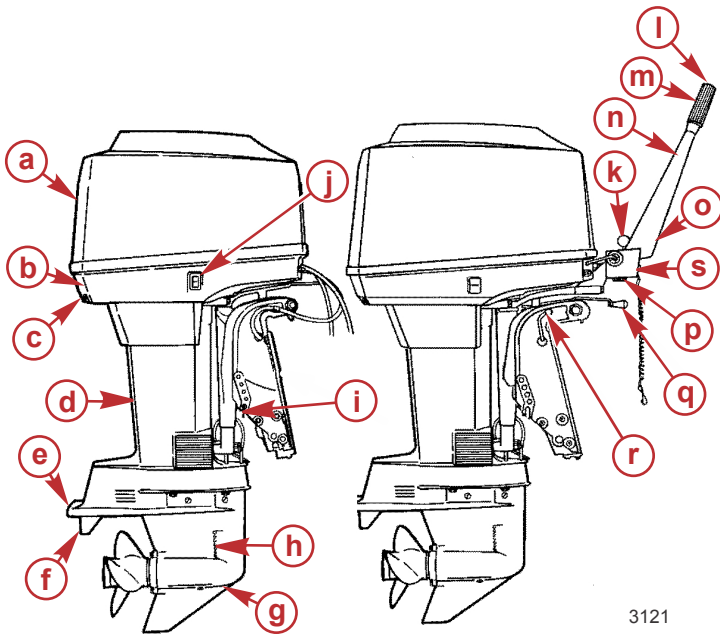

3121

- a** - Top cowl
- b** - Bottom cowl
- c** - Water pump indicator hole
- d** - Driveshaft housing
- e** - Anti-ventilation plate
- f** - Trim tab
- g** - Gearcase
- h** - Cooling water intake
- i** - Tilt pin
- j** - Auxiliary tilt switch (power trim models)
- k** - Shift handle
- l** - Stop switch
- m** - Throttle grip
- n** - Tiller handle
- o** - Throttle friction adjustment
- p** - Warning horn
- q** - Steering friction adjustment
- r** - Tilt lock lever (models without power trim)
- s** - Lanyard stop switch

# GENERAL INFORMATION

## 55/60 SeaPro/Marathon Component Identification

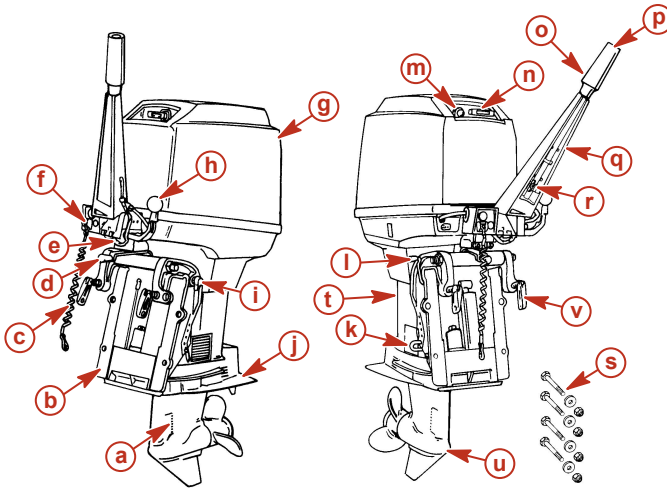

- a** - Water intake
- b** - Transom bracket
- c** - Lanyard cord
- d** - Steering friction adjustment
- e** - Warning horn
- f** - Lanyard stop switch
- g** - Top cowl
- h** - Shift handle
- i** - Tilt support lever
- j** - Anti-ventilation plate
- k** - Tilt pin
- l** - Tilt lock lever
- m** - Primer
- n** - Starter handle
- o** - Throttle grip
- p** - Stop button
- q** - Tiller handle
- r** - Throttle grip friction adjustment
- s** - Transom mounting hardware (bolts, flat washers, and locknuts)
- t** - Driveshaft housing
- u** - Gearcase
- v** - Transom clamp handles

# TRANSPORTING

## Trailing Boat/Outboard

Trail your boat with the outboard tilted down in a vertical operating position.

If additional ground clearance is required, the outboard should be tilted up using an accessory outboard support device. Refer to your local dealer for recommendations. Additional clearance may be required for railroad crossings, driveways, and trailer bouncing.

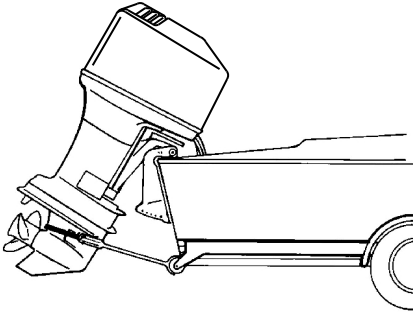

28419

**IMPORTANT: Do not rely on the power trim/tilt system or tilt support lever to maintain proper ground clearance for trailering. The outboard tilt support lever is not intended to support the outboard for trailering.**

Shift the outboard to forward gear. This prevents the propeller from spinning freely.

# FUEL AND OIL

## Fuel Recommendations

**IMPORTANT: Use of improper gasoline can damage your engine. Engine damage resulting from the use of improper gasoline is considered misuse of the engine, and damage caused thereby will not be covered under the limited warranty.**

### FUEL RATINGS

Mercury Marine engines will operate satisfactorily when using a major brand of unleaded gasoline meeting the following specifications:

**USA and Canada** - having a posted pump octane rating of 87 (R+M)/2 minimum. Premium gasoline (92 [R+M]/2 octane) is also acceptable. Do not use leaded gasoline.

**Outside USA and Canada** - having a posted pump octane rating of 90 RON minimum. Premium gasoline (98 RON) is also acceptable. If unleaded gasoline is not available, use a major brand of leaded gasoline.

### USING REFORMULATED (OXYGENATED) GASOLINES (USA ONLY)

This type of gasoline is required in certain areas of the USA. The two types of oxygenates used in these fuels are alcohol (ethanol) or ether (MTBE or ETBE). If ethanol is the oxygenate that is used in the gasoline in your area, refer to **Gasolines Containing Alcohol**.

These reformulated gasolines are acceptable for use in your Mercury Marine engine.

### GASOLINES CONTAINING ALCOHOL

If the gasoline in your area contains either methanol (methyl alcohol) or ethanol (ethyl alcohol), you should be aware of certain adverse effects that can occur. These adverse effects are more severe with methanol. Increasing the percentage of alcohol in the fuel can also worsen these adverse effects.

Some of these adverse effects are caused because the alcohol in the gasoline can absorb moisture from the air, resulting in a separation of the water/alcohol from the gasoline in the fuel tank.

The fuel system components on your Mercury Marine engine will withstand up to 10% alcohol content in the gasoline. We do not know what percentage your boat's fuel system will withstand. Contact your boat manufacturer for specific recommendations on the boat's fuel system components (fuel tanks, fuel lines, and fittings). Be aware that gasolines containing alcohol may cause increased:

- Corrosion of metal parts
- Deterioration of rubber or plastic parts
- Fuel permeation through rubber fuel lines
- Starting and operating difficulties

# FUEL AND OIL

## ⚠ WARNING

Fuel leakage is a fire or explosion hazard, which can cause serious injury or death. Periodically inspect all fuel system components for leaks, softening, hardening, swelling, or corrosion, particularly after storage. Any sign of leakage or deterioration requires replacement before further engine operation.

Because of possible adverse effects of alcohol in gasoline, it is recommended that only alcohol-free gasoline be used where possible. If only fuel containing alcohol is available, or if the presence of alcohol is unknown, increased inspection frequency for leaks and abnormalities is required.

**IMPORTANT:** When operating a Mercury Marine engine on gasoline containing alcohol, storage of gasoline in the fuel tank for long periods should be avoided. Long periods of storage, common to boats, create unique problems. In cars, alcohol-blend fuels normally are consumed before they can absorb enough moisture to cause trouble, but boats often sit idle long enough for phase separation to take place. In addition, internal corrosion may take place during storage if alcohol has washed protective oil films from internal components.

## Oil Recommendation

Recommended Oil	Mercury or Quicksilver Premium 2-Cycle TC-W3 Outboard Oil
-----------------	---

**IMPORTANT:** Oil must be NMMA certified TC-W3 2-Cycle oil.

Mercury or Quicksilver Premium TC-W3 2-Cycle oil is recommended for this engine. For added protection and lubrication, Mercury or Quicksilver Premium Plus TC-W3 2-Cycle oil is recommended. If Mercury or Quicksilver outboard oil is not available, substitute another brand of 2-cycle outboard oil that is NMMA Certified TC-W3. Severe engine damage may result from use of an inferior oil.

## Fuel and Oil Ratio

### MODELS WITH OIL INJECTION

Use a 50:1 (2%) gasoline/oil mixture in the first tank of fuel. Follow the table below for mixing ratios. Use of this fuel mixture combined with oil from the oil injection system will supply adequate lubrication during engine break-in.

After the break-in fuel mixture is used up, it is no longer necessary to add oil with the gasoline.

**NOTE:** At the end of the break-in period, visually check to see if the oil level in the oil injection system has dropped. Oil usage indicates the oil injection system is functioning correctly.



# FUEL AND OIL

GASOLINE/OIL MIXING RATIO CHART			
Gas/Oil Ratio	3.8 liters (1 gal.) gas	11.5 liters (3 gal.) gas	23 liters (6 gal.) gas
50:1 (2%)	89 ml (3 fl. oz.) oil	237 ml (8 fl. oz.) oil	473 ml (16 fl. oz.) oil

## MODELS WITHOUT OIL INJECTION

Use a 25:1 (4%) gasoline/oil mixture in the first tank of fuel.

After the break-in fuel mixture is used up, use a 50:1 (2%) gasoline/oil mixture. Follow the table for mixing ratios.

GASOLINE/OIL MIXING RATIO CHART			
Gas/Oil Ratio	3.8 liters (1 gal.) gas	11.5 liters (3 gal.) gas	23 liters (6 gal.) gas
25:1 (4%)	148 ml (5 fl. oz.) oil	473 ml (16 fl. oz.) oil	946 ml (32 fl. oz.) oil
50:1 (2%)	89 ml (3 fl. oz.) oil	237 ml (8 fl. oz.) oil	473 ml (16 fl. oz.) oil

## Filling Oil Injection System

1. Check oil level using the sight gauge in front of the outboard.
2. Remove the fill cap and fill tank with oil.

	Capacity	Fluid Type
Oil tank	3.2 liters (96 fl. oz.)	Mercury or Quicksilver Premium 2-cycle TC-W3 outboard oil

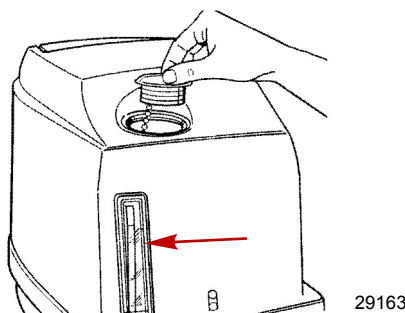

3. Reinstall fill cap and tighten securely.

## Filling Remote Oil Tank (If Equipped)

1. Remove fill cap and fill with the specified oil.

# FUEL AND OIL

	Capacity	Fluid Type
Oil tank	11.5 liters (3 gal.)	Mercury or Quicksilver Premium 2-cycle TC-W3 outboard oil

2. Reinstall filler cap and tighten securely.
3. Check oil level in the engine oil injection tank. The oil level should be 1/2 full to completely full. Refill if necessary.

**IMPORTANT: Always make sure the oil tank caps are threaded on tight. An air leak will prevent oil flow to the engine.**

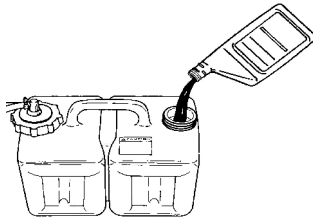

2723

## Filling Fuel Tank

### **⚠ WARNING**

**Avoid serious injury or death from a gasoline fire or explosion. Use caution when filling fuel tanks. Always stop the engine and do not smoke or allow open flames or sparks in the area while filling fuel tanks.**

Fill the fuel tanks outdoors away from heat, sparks, and open flames.

Remove the portable fuel tanks from the boat to fill them.

Always stop the engine before filling the tanks.

Do not completely fill the fuel tanks. Leave approximately 10% of the tank volume unfilled. Fuel will expand in volume as its temperature rises and can leak under pressure if the tank is completely filled.

### **PORTABLE FUEL TANK PLACEMENT IN THE BOAT**

Place the fuel tank in the boat so the vent is higher than the fuel level under normal boat operating conditions.

# FEATURES AND CONTROLS

## Remote Control Features

Your boat may be equipped with one of the Mercury Precision or Quicksilver remote controls shown. If not, consult your dealer for a description of the functions and operations of the remote control.

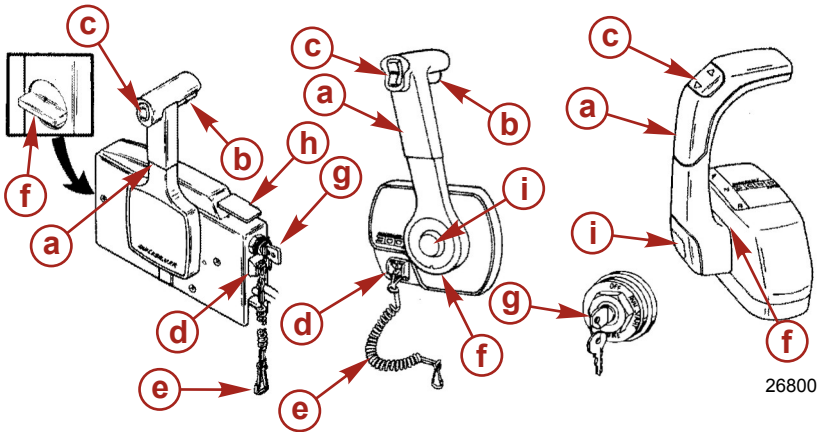

- a** - Control handle – forward, neutral, reverse
- b** - Neutral release lever
- c** - Trim/tilt switch (if equipped) – Refer to **Features and Controls – Power Trim and Tilt**
- d** - Lanyard stop switch – Refer to **General Information – Lanyard Stop Switch**
- e** - Lanyard – Refer to **General Information – Lanyard Stop Switch**
- f** - Throttle friction adjustment – Console controls require cover removal for adjustment
- g** - Ignition key switch – "OFF," "ON," "START"
- h** - Fast idle lever – Refer to **Operation – Starting the Engine**
- i** - Throttle only button – Refer to **Operation – Starting the Engine**

# FEATURES AND CONTROLS

## Warning System

The outboard warning system incorporates a warning horn inside the boat. Remote control models will have the warning horn located inside the remote control or connected to the ignition key switch.

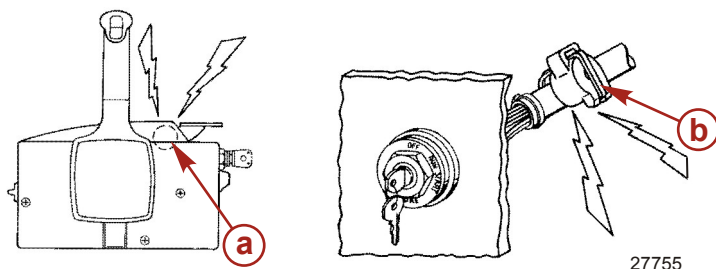

- a** - Warning horn inside remote control
- b** - Warning horn inside key switch

Tiller handle models will have the warning horn located below the tiller handle.

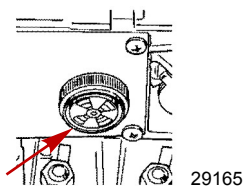

## WARNING SYSTEM OPERATION

The warning horn will emit a continuous beep. This will alert the operator and help identify the following listed situations.

Warning System		
Function	Sound	Description
Engine Over Temperature	Continuous	Engine Over Heat
Low Oil Level (Oil Injected Models)	Continuous	Low Oil Level

# FEATURES AND CONTROLS

## ENGINE OVERHEAT

If the engine overheats, immediately reduce throttle speed to idle. Shift outboard into neutral and check for a steady stream of water coming out of the water pump indicator hole.

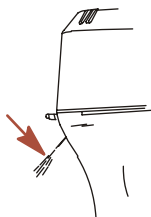

19805

If no water is coming out of the water pump indicator hole or flow is intermittent, stop engine and check the cooling water intake holes for obstruction. If no obstruction is found, there may be a blockage in the cooling system or a water pump problem. Have the outboard checked by your dealer. Operating the engine while overheated will cause engine damage.

**NOTE:** *Should overheating occur and you are stranded, stop the engine and allow it to cool down. This will usually allow some additional low speed (idle) running time before the engine starts to overheat again. Operating an overheated engine will cause engine damage.*

If a steady flow of water is coming out of the water pump indicator hole and the engine continues to overheat, consult your dealer. Operating an overheated engine will cause engine damage.

## LOW OIL LEVEL

The warning system will be activated if the oil level drops below the sight gauge in the cowl when the outboard is in a vertical position. There is still oil reserve remaining for 30 minutes of full speed operation. Refer to **Fuel & Oil - Filling Oil Injection System**.

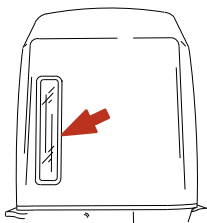

3103

## Engine Over-Speed Limiter

The outboard is equipped with an engine over-speed limiter which limits the engine maximum RPM. This will protect the engine from mechanical damage.

Some causes of engine over-speed are as follows:

# FEATURES AND CONTROLS

- Propeller ventilation.
- A propeller which has an incorrect pitch or diameter.
- Propeller hub slippage.
- Outboard mounted too high on the transom.
- Tilting the outboard out beyond a vertical position.
- Cavitation of the propeller due to rough water or obstruction in the boat hull.

When the engine over-speed limiter is activated, the engine timing will be momentarily retarded to decrease the engine speed. Excessive over-speed (above 5700 RPM) will result in cutout of the cylinders ignition to prevent operation above this limit.

## Power Trim And Tilt (If equipped)

Your outboard has a trim/tilt control called Power Trim. This enables the operator to easily adjust the position of the outboard by pressing the trim switch. Moving the outboard in closer to the boat transom is called trimming in or down. Moving the outboard further away from the boat transom is called trimming out or up. The term trim generally refers to the adjustment of the outboard within the first 20° range of travel. This is the range used while operating your boat on plane. The term tilt is generally used when referring to adjusting the outboard further up out of the water. With the engine turned off, the outboard can be tilted out of the water. At low idle speed, the outboard can also be tilted up past the trim range to permit, for example, shallow water operation.

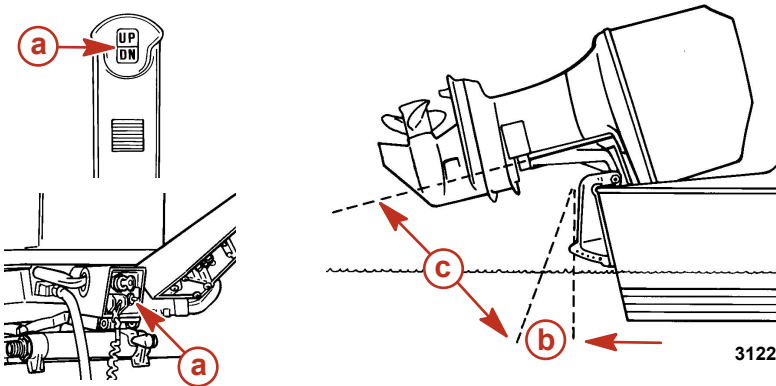

- a** - Trim switch
- b** - Trim range of travel
- c** - Tilt range of travel

# FEATURES AND CONTROLS

## POWER TRIM OPERATION

With most boats, operating around the middle of the trim range will give satisfactory results. However, to take full advantage of the trimming capability there may be times when you choose to trim your outboard all the way in or out. Along with an improvement in some performance aspects comes a greater responsibility for the operator, and this is being aware of some potential control hazards.

The most significant control hazard is a pull or torque that can be felt on the steering wheel or tiller handle. This steering torque results from the outboard being trimmed so the propeller shaft is not parallel to the water surface.

### **⚠ WARNING**

**Trimming the outboard beyond a neutral steering condition may result in a pull on the steering wheel or tiller handle and loss of boat control. Maintain control of the boat if trimming beyond a neutral steering condition.**

Consider the following lists carefully.

1. Trimming in or down can:
  - Lower the bow.
  - Result in quicker planing off, especially with a heavy load or a stern heavy boat.
  - Generally improve the ride in choppy water.
  - Increase steering torque or pull to the right (with the normal right-hand rotation propeller.)
  - In excess, can lower the bow of some boats to a point where they begin to plow with their bow in the water while on plane. This can result in an unexpected turn in either direction (called bow steering or oversteering) if any turn is attempted, or if a significant wave is encountered.

### **⚠ WARNING**

**Operating the boat at high speeds with the outboard trimmed too far under can create excessive bow steer, resulting in the operator losing control of the boat. Install the trim limit pin in a position that prevents excessive trim under and operate the boat in a safe manner.**

- In rare circumstances, the owner may decide to limit the trim in. This can be accomplished by purchasing a stainless steel tilt pin from your dealer and inserting it in whatever adjustment hole in the transom brackets is desired. The nonstainless steel shipping bolt should not be used in this application other than on a temporary basis.
2. Trimming out or up can:
    - Lift the bow higher out of the water.
    - Generally increase top speed.

# FEATURES AND CONTROLS

- Increase clearance over submerged objects or a shallow bottom.
- Increase steering torque or pull to the left at a normal installation height (with the normal right-hand rotation propeller.)
- In excess, can cause boat porpoising (bouncing) or propeller ventilation.
- Cause engine overheating if any cooling water intake holes are above the waterline.

## TILTING OPERATION

To tilt outboard, shut off the engine and press the trim/tilt switch or auxiliary tilt switch to the up position. The outboard will tilt up until the switch is released or it reaches its maximum tilt position.

1. Engage the tilt support lever, by rotating knob to bring the support lever upward.
2. Lower outboard to rest on the tilt support lever.
3. Disengage the tilt support lever, by raising the outboard off the support lever and rotating the lever down. Lower the outboard.

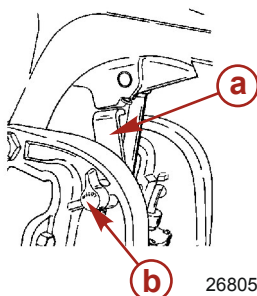

- a - Tilt support lever
- b - Knob

## MANUAL TILTING

If the outboard cannot be tilted using the power trim/tilt switch, the outboard can be manually tilted.

1. Turn out the manual tilt release valve 3 turns (counterclockwise). This allows manual tilting of the outboard.

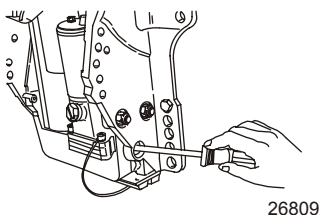

**NOTE:** The manual tilt release valve must be tightened before operating the outboard to prevent the outboard from tilting up during reverse operation.



# FEATURES AND CONTROLS

2. Tilt the outboard to the desired position and tighten the manual tilt release valve.

## AUXILIARY TILT SWITCH

The auxiliary tilt switch can be used to tilt the outboard up or down using the power trim system.

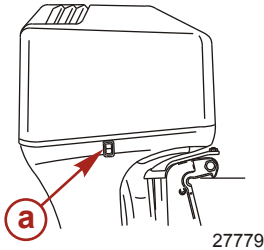

**a** - Auxiliary tilt switch

## SHALLOW WATER OPERATION

When operating your boat in shallow water, you can tilt the outboard beyond the maximum trim range to prevent hitting bottom.

1. Reduce the engine speed below 2000 RPM.
2. Tilt the outboard up. Make sure all the water intake holes stay submerged at all times.
3. Operate the engine at slow speed only. If engine speed exceeds 2000 RPM, the outboard will automatically return down to the maximum trim range.

## Manual Tilt System

Models without power trim are equipped with a tilt assist system that allows the operator to easily tilt and lock the outboard at any tilt position from full down to full up.

This tilt system is designed to be adjusted when the outboard is idling in neutral or with the engine turned off.

### **▲ WARNING**

**Operating the engine without engaging the tilt lock lever can cause serious injury or death. The outboard can tilt upwards when decelerating or operating in reverse, causing loss of boat control. Always lock the outboard in its run position before operating.**

Before operating, the outboard must be locked in its tilt position by moving the tilt lock lever to the lock/run position.

# FEATURES AND CONTROLS

## BASIC TILTING OPERATION

Move tilt lock lever to the tilt position. Tilt outboard to desired position and lock in place by moving the tilt lock lever back to the lock/run position.

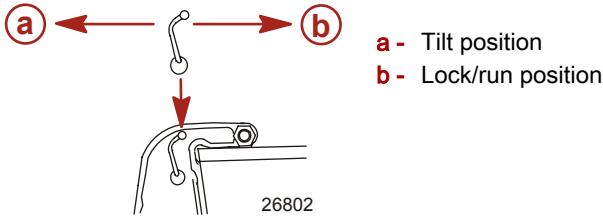

## SHALLOW WATER OPERATION

When operating the boat in shallow water, the outboard can be adjusted and locked at a higher tilt angle. Operate the outboard at slow speed while tilted up for shallow water operation. Keep the cooling water intake holes submerged in the water and continue to check for water discharge from the water pump indicator hole.

## TILTING OUTBOARD

### Tilting To Full Up Position

1. Stop the engine. Move the tilt lock lever to the tilt position. Take hold of the top cowl grip and raise outboard to full tilt up position. Lock the outboard in place by moving the tilt lock lever to the lock/run position.

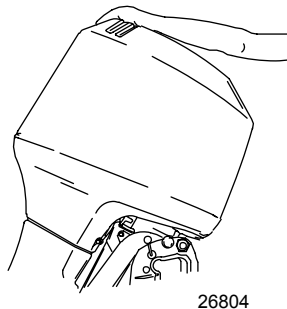

# FEATURES AND CONTROLS

2. Engage the tilt support lever by rotating knob to bring the tilt support lever upward.

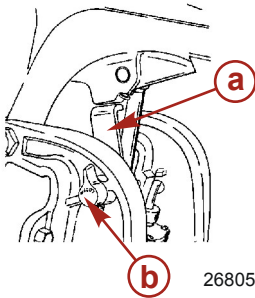

- a - Tilt support lever
- b - Knob

3. Lower outboard to rest on the tilt support lever.

## Lowering To Run Position

1. Disengage the tilt support lever by raising the outboard off the tilt support lever and rotating the lever down. Lower the outboard.
2. Move tilt lock lever to lock/run position.

## SETTING THE OPERATING ANGLE OF THE OUTBOARD

The vertical operating angle of your outboard is adjusted by changing the position of the tilt pin in the five adjustment holes provided. The outboard should be locked against this tilt pin by setting the tilt lock lever to the lock/run position. Proper adjustment allows the boat to achieve optimum performance, stability and minimize steering effort.

**NOTE:** Refer to the following lists when adjusting the operating angle of your outboard.

The tilt pin should be adjusted so the outboard is positioned to run perpendicular to the water when the boat is running at full speed. This allows the boat to be driven parallel to the water.

# FEATURES AND CONTROLS

Arrange passengers and load in the boat so the weight is distributed evenly.

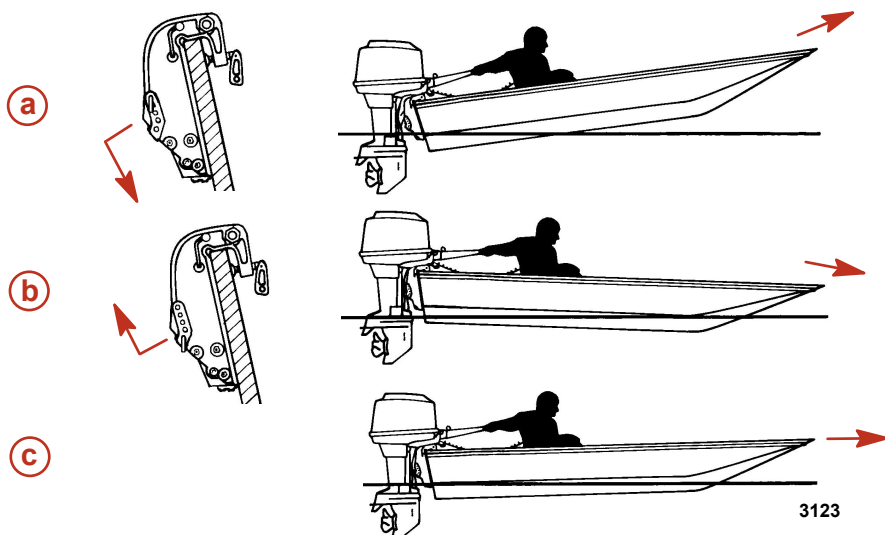

- a** - Too much angle (stern down - bow up)
- b** - Not enough angle (stern up - bow down)
- c** - Angle adjusted properly (bow slightly up)

Consider the following lists carefully when adjusting the operating angle of your outboard.

Adjusting the outboard close to the boat transom can:

- Lower the bow.
- Result in quicker planing off, especially with a heavy load or a stern heavy boat.
- Generally improve the ride in choppy water.
- Increase steering torque or pull to the right (with the normal right hand rotation propeller).
- In excess can lower the bow of some boats to a point where they begin to plow with their bow in the water while on plane. This can result in an unexpected turn in either direction (called bow steering, or over-steering) if any turn is attempted or if a significant wave is encountered.

Adjusting the outboard away from the boat transom can:

- Lift the bow out of the water.
- Generally increase top speed.
- Increase clearance over submerged objects or a shallow bottom.
- Increase steering torque or pull to the left at a normal installation height (with the normal right hand rotation propeller).

# FEATURES AND CONTROLS

- In excess can cause boat porpoising (bouncing) or propeller ventilation.

## Throttle Grip Friction Adjustment - Tiller Handle Models

Turn the wing nut to set and maintain the throttle at desired speed.

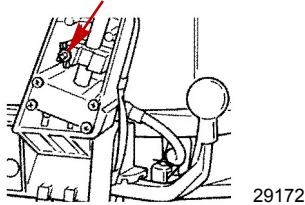

## Steering Friction Adjustment - Tiller Handle Models

### ▲ WARNING

Insufficient friction adjustment can cause serious injury or death due to loss of boat control. When setting the friction adjustment, maintain sufficient steering friction to prevent the outboard from steering into a full turn if the tiller handle or steering wheel is released.

Adjust this lever to achieve the desired steering friction (drag) on the tiller handle.

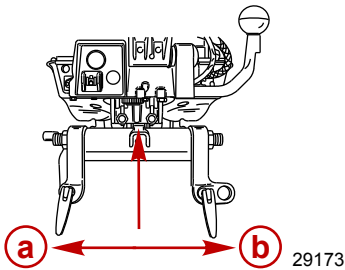

- a** - Tighten friction
- b** - Loosen friction

# FEATURES AND CONTROLS

## Trim Tab Adjustment

Propeller steering torque will cause your boat to pull in one direction. This steering torque is a normal result from your outboard not trimmed with the propeller shaft parallel to the water surface. The trim tab can help to compensate for this steering torque in many cases and can be adjusted within limits to reduce any unequal steering effort.

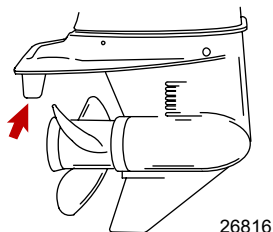

**NOTE:** Trim tab adjustment will have little effect reducing steering torque if the outboard is installed with the anti-ventilation plate approximately 50 mm (2 in.) or more above the boat bottom.

## MODELS WITHOUT POWER TRIM

Operate your boat at normal cruising speed trimmed to desired position by installing the tilt pin in the desired tilt pin hole. Turn your boat left and right and note the direction the boat turns more easily.

If adjustment is necessary, loosen trim tab bolt and make small adjustments at a time. If the boat turns more easily to the left, move the trailing edge of trim tab to the left. If the boat turns more easily to the right, move the trailing edge of trim tab to the right. Retighten bolt and retest.

## MODELS WITH POWER TRIM

Operate your boat at normal cruising speed, trimmed to desired position. Turn your boat left and right and note the direction the boat turns more easily.

If adjustment is necessary, loosen trim tab bolt and make small adjustments at a time. If the boat turns more easily to the left, move the trailing edge of trim tab to the left. If the boat turns more easily to the right, move the trailing edge of trim tab to the right. Retighten bolt and retest.

# OPERATION

## Important Daily Inspection Before Each Use

Any outboard mounted on the boat must have the mounting hardware inspected and checked to ensure that the hardware has not become loose. A decal on the transom bracket reminds the owner to check the fasteners securing the outboard to the transom before each use.

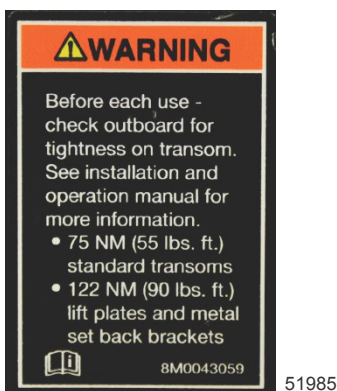

**Decal on the transom bracket**

## Prestarting Check List

- Operator knows safe navigation, boating, and operating procedures.
- An approved personal flotation device of suitable size for each person aboard and readily accessible. It is the law.
- A ring-type life buoy or buoyant cushion designed to be thrown to a person in the water.
- Know the boat's maximum load capacity. Look at the boat capacity plate.
- Fuel supply OK.
- Oil supply (oil injection) OK.
- Arrange passengers and load in the boat so the weight is distributed evenly and everyone is seated in a proper seat.
- Tell someone where you are going and when you expect to return.
- It is illegal to operate a boat while under the influence of alcohol or drugs.
- Know the waters and area you will be boating; tides, currents, sand bars, rocks, and other hazards.
- Make the inspection checks listed in **Maintenance - Inspection and Maintenance Schedule**.

# OPERATION

## Operating in Freezing Temperatures

When using your outboard or having your outboard moored in freezing or near freezing temperatures, keep the outboard tilted down at all times so the gearcase is submerged. This prevents the trapped water in the gearcase from freezing and causing possible damage to the water pump and other components.

If there is a chance of ice forming on the water, the outboard should be removed and drained completely of water. If ice should form at the water level inside the outboard driveshaft housing, it will block water flow to the engine causing possible damage.

## Operating in Saltwater or Polluted Water

We recommend that you flush the internal water passages of your outboard with fresh water after each use in salt or polluted water. This will prevent a buildup of deposits from clogging the water passages. Refer to **Maintenance - Flushing the Cooling System**.

If you keep your boat moored in the water, always tilt the outboard so the gearcase is completely out of water (except in freezing temperatures) when not in use.

Wash the outboard exterior and flush out the exhaust outlet of the propeller and gearcase with fresh water after each use. Each month, spray Mercury Precision or Quicksilver Corrosion Guard on external metal surfaces. Do not spray on corrosion control anodes as this will reduce the effectiveness of the anodes.

## Effects of Elevation and Weather on Performance

The following conditions lower engine performance and cannot be compensated by the engine fuel or electronic management systems:

- Above sea level elevations
- High temperature
- Low barometric pressure
- High humidity

These conditions above reduce air density to the engine, which in turn lowers the following:

- Boost pressure on supercharged engines
- Horsepower and torque throughout the RPM range
- Peak RPM
- Cranking compression

**EXAMPLE:** An engine running at an elevation of 8,000 feet will have over a 30% power loss while a loss of engine power on a hot and humid day could be as much as 14%. These losses apply to normally aspirated and supercharged engines.

### **Compensating for power robbing conditions:**

- Switch to lower pitch propeller.



# OPERATION

- Change gear ratio.

Some boat performance can be improved by dropping to a lower pitch propeller, but engine performance will still remain lower. In some cases, a gear ratio reduction may be more beneficial. To optimize engine performance, prop the engine to allow it to operate at or near the top end of the recommended maximum RPM range at wide-open throttle with a normal boat load.

Other advantages to propeller or gear ratio changes:

- Reduces the possibility of detonation
- Enhances overall reliability and durability of the engine

## Operating at High Elevations

**IMPORTANT: To prevent serious damage to the engine caused by a lean fuel mixture, do not operate your outboard (if the jets were changed for high elevation) at a lower elevation unless the jets are changed again to correspond to the new elevation.**

Operating your outboard at an elevation higher than 750 m (2500 ft.) above sea level may require a carburetor jet change and/or different pitch propeller.

Consult your dealer. This will reduce the normal performance loss experienced as a result of reduced oxygen in the air causing an overly rich fuel mixture.

## Engine Break-in Procedure

**IMPORTANT: Failure to follow the engine break-in procedures can result in poor performance throughout the life of the engine and can cause engine damage. Always follow break-in procedures.**

### MODELS WITH OIL INJECTION

**Engine Break-in Fuel Mixture** - Use a 50:1 (2%) gasoline/oil mixture in the first tank of fuel. Use of this fuel mixture combined with oil from the oil injection system will supply adequate lubrication during engine break-in.

**Engine Break-in Procedure** - Vary the throttle setting during the first hour of operation. During the first hour of operation, avoid remaining at constant speed for more than two minutes and avoid sustained wide open throttle.

### MODELS WITHOUT OIL INJECTION

**Engine Break-in Fuel Mixture** - Use a 25:1 (4%) gasoline/oil mixture in the first tank of fuel. After the break-in fuel mixture is used up, use a 50:1 (2%) gasoline/oil mixture.

**Engine Break-in Procedure** - Vary the throttle setting during the first hour of operation. During the first hour of operation, avoid remaining at constant speed for more than two minutes and avoid sustained wide open throttle.

## Starting The Engine

Before starting, read the Pre-Starting Check List, Special Operating Instructions, and Engine Break-in Procedure in the Operation section.

# OPERATION

## NOTICE

Without sufficient cooling water, the engine, the water pump, and other components will overheat and suffer damage. Provide a sufficient supply of water to the water inlets during operation.

1. Lower the outboard to the vertical operating position. Make sure all cooling water intake holes are submerged.

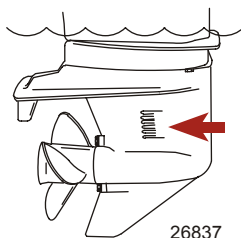

2. Open fuel tank vent screw (in filler cap) on manual venting type fuel tanks.

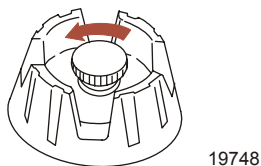

3. Connect the fuel line to the outboard.

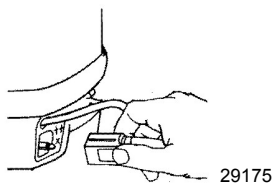

4. Squeeze the fuel line primer bulb several times until it feels firm.

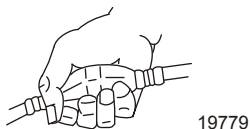

**NOTE:** The engine will not start unless the lanyard is set to the "RUN" position.

# OPERATION

5. Set the lanyard stop switch to the "RUN" position. Refer to **General Information - Lanyard Stop Switch**.

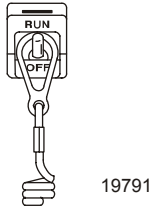

6. Shift outboard to neutral (N) position.

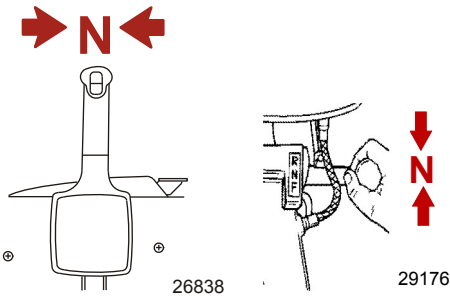

7. Model without power trim - Position tilt lock lever to the lock/run position.

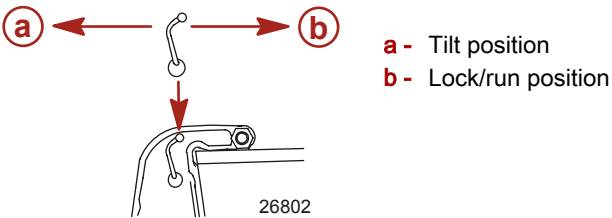

8. Tiller handle models - Align the throttle grip pointer to the "START" position.

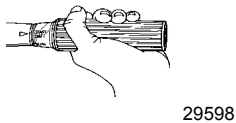

9. Starting a cold engine:

# OPERATION

- a. Remote control models - Advance the fast idle speed lever of throttle only feature to an approximate halfway setting. After engine start up, immediately adjust neutral fast idle setting so engine speed drops below 2000 RPM. Return back to normal idle speed after engine is warmed up.

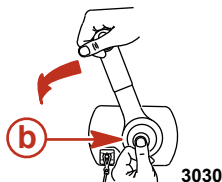
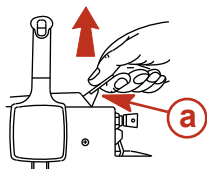

- a - Fast idle speed lever  
b - Throttle only feature

- b. Manual start models - Depress fuel primer rapidly 4 to 6 times.

**NOTE:** For initial start of a new engine or first start after a prolonged storage, air may be present in primer. If this is the case, primer several times until fluid can be felt and then the normal 4 to 6 times.

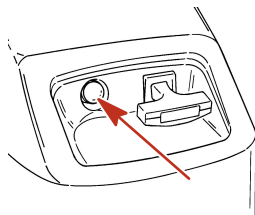

3076

## 10. Starting a flooded engine:

- a. Tiller handle models - Advance the throttle grip to full throttle speed. Without activating primer, start engine following starting procedure. Immediately start to reduce engine speed after engine starts.
- b. Remote control models - Advance the fast idle speed lever or throttle only feature to the full maximum position. Without activating the primer, crank engine for 10 seconds. Wait 30 seconds and repeat until engine starts. Immediately start to reduce engine speed after engine starts.

11. Turn ignition key to "START" position and start the engine. If engine is cold, push in on key to prime the engine while cranking. If engine fails to start in ten seconds, wait 30 seconds and try again. If engine begins to stall, reprime until engine is running smoothly.

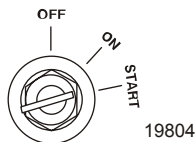

19804

# OPERATION

## ▲ WARNING

Rapid acceleration can result in serious injury or death from being thrown within or out of the boat. Decrease engine speed before shifting into gear.

12. Manual start models - Pull starter rope.

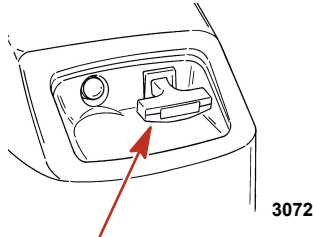

13. After engine starts, check for a steady stream of water flowing out of the water pump indicator hole.

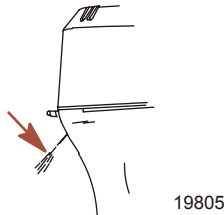

**IMPORTANT:** If no water is coming out of the water pump indicator hole, stop engine and check cooling water intake for obstruction. No obstruction may indicate a water pump failure or blockage in the cooling system. These conditions will cause the engine to overheat. Have the outboard checked by your dealer. Operating the engine while overheated may cause serious engine damage.

## Gear Shifting

**IMPORTANT:** Never shift outboard into gear unless engine speed is at idle. Do not shift outboard into reverse when the engine is not running.

- The outboard has three gear shift positions to provide operation: Forward (F), Neutral (N), and Reverse (R).

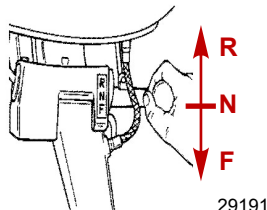
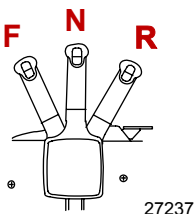

# OPERATION

- Remote control models - When shifting, always stop at neutral position and allow the engine speed to return to idle.

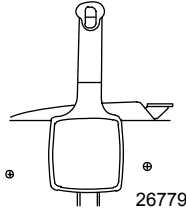

- Tiller handle models - Reduce engine speed to idle before shifting.

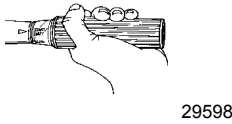

- Always shift outboard into gear with a quick motion.
- After shifting outboard into gear, advance the remote control lever or rotate the throttle grip (tiller handle) to increase speed.

## Stopping the Engine

1. **Remote control models** - Reduce the engine speed and shift the outboard to neutral position. Turn the ignition key to "OFF" position.

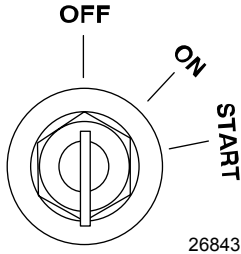

# OPERATION

2. **Tiller handle models** - Reduce the engine speed and shift the outboard to neutral position. Push in the engine stop button or turn the ignition key to "OFF" position.

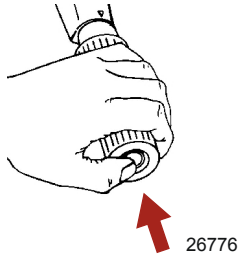

## Emergency Starting

If the starter system fails, use the spare starter rope (provided) and follow procedure.

1. Remove flywheel cover.

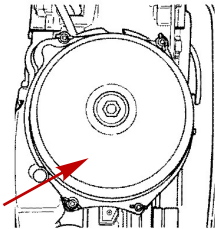

Electric start models

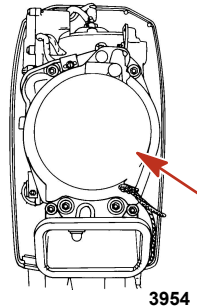

Manual start models

### **▲ WARNING**

The neutral-speed-protection device is inoperative when starting the engine with the emergency starter rope. Set the engine speed at idle and the gear shift in neutral to prevent the outboard from starting in gear.

# OPERATION

2. Shift outboard to neutral (N) position.

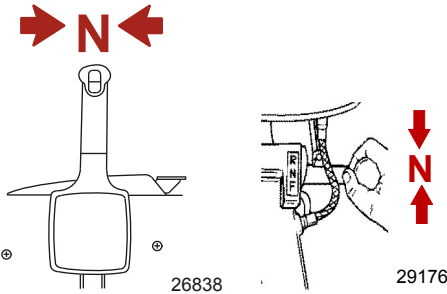

3. Turn the ignition key to "ON" position.

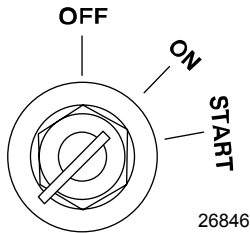

4. Set the lanyard stop switch to the "RUN" position. Refer to **General Information - Lanyard Stop Switch**.

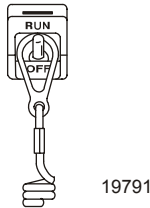

## ▲ WARNING

High voltage is present any time the key is turned on, especially when starting or operating the engine. Do not touch ignition components or metal test probes and stay clear of spark plug leads when performing live tests.

## ▲ WARNING

The exposed moving flywheel can cause serious injury. Keep your hands, hair, clothing, tools, and other objects away from engine when starting or running the engine. Do not attempt to reinstall the flywheel cover or top cowl when engine is running.



# OPERATION

5. Place starter rope knot into the flywheel notch and wind the rope clockwise around the flywheel.

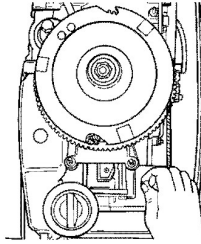

29193

6. If engine is cold, hold the fuel primer button in and pump up the fuel pressure with the fuel primer bulb.

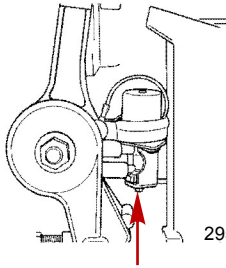

29544

7. Pull the starter rope to start the engine.

# MAINTENANCE

## Outboard Care

To keep your outboard in the best operating condition, it is important that your outboard receive the periodic inspections and maintenance listed in the **Inspection and Maintenance Schedule**. We urge you to keep it maintained properly to ensure the safety of you and your passengers, and retain its dependability.

Record maintenance performed in the **Maintenance Log** at the back of this book. Save all maintenance work orders and receipts.

## SELECTING REPLACEMENT PARTS FOR YOUR OUTBOARD

We recommend using original Mercury Precision or Quicksilver replacement parts and Genuine Lubricants.

## EPA Regulations

All new outboards manufactured by Mercury Marine are certified to the United States Environmental Protection Agency, as conforming to the requirements of the regulations for the control of air pollution from new outboard motors. This certification is contingent on certain adjustments being set to factory standards. For this reason, the factory procedure for servicing the product must be strictly followed and, wherever practicable, returned to the original intent of the design.

**Maintenance, replacement, or repair of the emission control devices and systems may be performed by any marine spark ignition (SI) engine repair establishment or individual.**

# MAINTENANCE

## EPA Emissions

### EMISSION CERTIFICATION LABEL

An emission certification label, showing emission levels and engine specifications directly related to emissions, is placed on the engine at time of manufacture.

The diagram shows a rectangular label with the Mercury logo on the left and the title "EMISSION CONTROL INFORMATION" on the right. The label contains several fields for engine specifications and emissions data. Red circles with letters a through i are placed around the label, with arrows pointing to specific fields: a points to the "IDLE SPEED" field; b points to the "hp" field; c points to the "TIMING (IN DEGREES)" field; d points to the "Standard spark plug" and "GAP" fields; e points to the "Valve Clearance (Cold) mm" field; f points to the "FAMILY" field; g points to the "FEL" field; h points to the "cc" field; and i points to a date field on the right side of the label. The label also includes a disclaimer: "This engine conforms to [ ] model year EPA regulations for Marine SI engines. Refer to Owner's Manual for required maintenance." and a small square field for the date of manufacture.

<b>MERCURY</b>		<b>EMISSION CONTROL INFORMATION</b>	
This engine conforms to [ ] model year EPA regulations for Marine SI engines. Refer to Owner's Manual for required maintenance.			
IDLE SPEED: [ ]		FAMILY: [ ]	
[ ] hp	[ ] cc	FEL: [ ] g/kWh	
TIMING (IN DEGREES): [ ]			
Standard spark plug: [ ]		[ ]	
Suppressor spark plug: [ ]		[ ]	
GAP: [ ]		[ ]	
Valve Clearance (Cold) mm		Intake	[ ]
		Exhaust	[ ]

28405

- a - Idle speed
- b - Engine horsepower
- c - Timing specification
- d - Recommended spark plug and gap
- e - Valve clearance (if applicable)
- f - Family number
- g - Maximum emission output for the engine family
- h - Piston displacement
- i - Date of manufacture

## OWNER RESPONSIBILITY

The owner/operator is required to have routine engine maintenance performed to maintain emission levels within prescribed certification standards.

The owner/operator is not to modify the engine in any manner that would alter the horsepower or allow emission levels to exceed their predetermined factory specifications.

## Inspection and Maintenance Schedule

### BEFORE EACH USE

- Check that lanyard stop switch stops the engine.
- Visually inspect the fuel system for deterioration or leaks.
- Check outboard for tightness on transom.
- Check steering system for binding or loose components.
- Remote control models - Visually check steering link rod fasteners for proper tightness. See **Steering Link Rod Fasteners**.

# MAINTENANCE

- Check propeller blades for damage.

## AFTER EACH USE

- Flush out the outboard cooling system if operating in salt or polluted water. See **Flushing the Cooling System**.
- Wash off all salt deposits and flush out the exhaust outlet of the propeller and gearcase with fresh water if operating in saltwater.

## EVERY 100 HOURS OF USE OR ONCE YEARLY, WHICHEVER OCCURS FIRST

- Lubricate all lubrication points. Lubricate more frequently when used in saltwater. See **Lubrication Points**.
- Inspect and clean spark plugs. See **Spark Plug Inspection and Replacement**.
- Check engine fuel filter for contaminants. See **Fuel System**.
- Adjust carburetors. (If required)<sup>1</sup>.
- Check engine timing setup.<sup>1</sup>
- Check corrosion control anodes. Check more frequently when used in saltwater. See **Corrosion Control Anodes**.
- Drain and replace gearcase lubricant. See **Gearcase Lubrication**.
- Lubricate splines on the driveshaft.<sup>1</sup>
- Check power trim fluid. See **Checking Power Trim Fluid**.
- Inspect battery. See **Battery Inspection**.
- Check control cable adjustments.<sup>1</sup>
- Remove engine deposits with Mercury Precision or Quicksilver Power Tune Engine Cleaner.
- Check tightness of bolts, nuts, and other fasteners.

## EVERY 300 HOURS OF USE OR THREE YEARS

- Replace water pump impeller (more often if overheating occurs or reduced water pressure is noted).<sup>1</sup>

## BEFORE PERIODS OF STORAGE

- Refer to storage procedure. See **Storage** section.

## Flushing the Cooling System

Flush the internal water passages of the outboard with fresh water after each use in salt, polluted, or muddy water. This will help prevent a buildup of deposits from clogging the internal water passages.

Use a Mercury Precision or Quicksilver accessory (or equivalent) flushing attachment.

<sup>1</sup>. These items should be serviced by an authorized dealer.

# MAINTENANCE

## ⚠ WARNING

Rotating propellers can cause serious injury or death. Never operate the boat out of the water with a propeller installed. Before installing or removing a propeller, place the drive unit in neutral and engage the lanyard stop switch to prevent the engine from starting. Place a block of wood between the propeller blade and the anti-ventilation plate.

1. Remove propeller. Refer to **Propeller Replacement**. Install the flushing attachment so the rubber cups fit tightly over the cooling water intake.

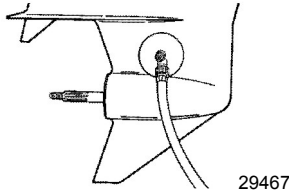

2. Attach a water hose to the flushing attachment. Turn on the water and adjust the flow so water is leaking around the rubber cups to ensure the engine receives an adequate supply of cooling water.

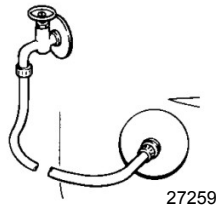

3. Start the engine and run it at idle speed in neutral shift position.  
**IMPORTANT: Do not run engine above idle when flushing.**
4. Adjust water flow (if necessary) so excess water continues leaking out from around the rubber cups to ensure the engine is receiving an adequate supply of cooling water.

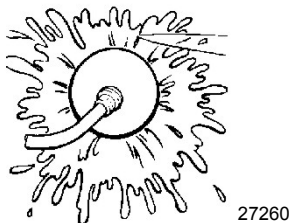

# MAINTENANCE

5. Check for a steady stream of water flowing out of the water pump indicator hole. Continue flushing the outboard for 3 to 5 minutes, carefully monitoring water supply at all times.
6. Stop the engine, turn off the water, and remove the flushing attachment. Reinstall the propeller.

## Top Cowl Removal And Installation

### REMOVAL

1. Unlock the rear latch by pushing lever down.

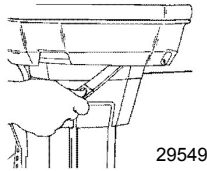

2. Lift rear of cowl and disengage front hook.

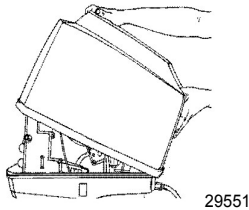

### INSTALLATION

1. Engage the front hook and push cowl back over the cowl seal.
2. Push cowl down and move the rear latch lever up to lock.

## Battery Inspection

The battery should be inspected at periodic intervals to ensure proper engine starting capability.

**IMPORTANT: Read the safety and maintenance instructions which accompany your battery.**

1. Turn off the engine before servicing the battery.
2. Ensure the battery is secure against movement.
3. Battery cable terminals should be clean, tight, and correctly installed. Positive to positive and negative to negative.
4. Ensure the battery is equipped with a nonconductive shield to prevent accidental shorting of battery terminals.

# MAINTENANCE

## Fuel System

### ⚠ WARNING

Fuel is flammable and explosive. Ensure that the key switch is off and the lanyard is positioned so that the engine cannot start. Do not smoke or allow sources of spark or open flame in the area while servicing. Keep the work area well ventilated and avoid prolonged exposure to vapors. Always check for leaks before attempting to start the engine, and wipe up any spilled fuel immediately.

Before servicing any part of the fuel system, stop the engine and disconnect the battery. Drain the fuel system completely. Use an approved container to collect and store fuel. Wipe up any spillage immediately. Material used to contain spillage must be disposed of in an approved receptacle. Any fuel system service must be performed in a well-ventilated area. Inspect any completed service work for sign of fuel leakage.

### FUEL LINE FILTER

Inspect the fuel line filter. If the filter appears to be contaminated, remove and replace.

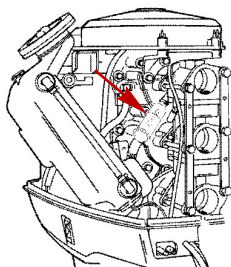

29558

**IMPORTANT:** Visually inspect for fuel leakage from the filter connections by squeezing the primer bulb until firm, forcing fuel into the filter.

### SEA PRO/MARATHON MODELS

#### Fuel Pump Filter

### ⚠ WARNING

Fuel is flammable and explosive. Ensure that the key switch is off and the lanyard is positioned so that the engine cannot start. Do not smoke or allow sources of spark or open flame in the area while servicing. Keep the work area well ventilated and avoid prolonged exposure to vapors. Always check for leaks before attempting to start the engine, and wipe up any spilled fuel immediately.

# MAINTENANCE

1. Remove the filter.

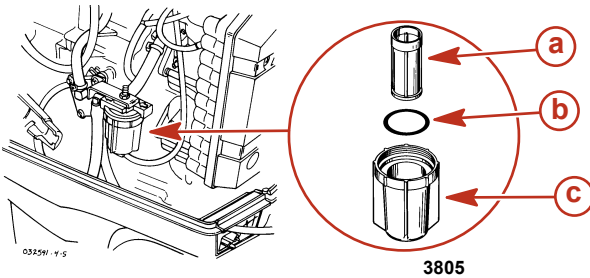

- a - Filter
- b - O-ring seal
- c - Sight bowl

2. Wash sight bowl and filter in cleaning solvent.

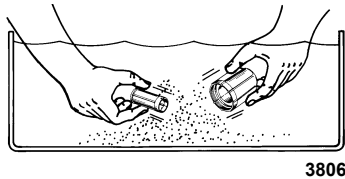

## Carburetor Fuel Bowl

### ⚠ WARNING

Fuel is flammable and explosive. Ensure that the key switch is off and the lanyard is positioned so that the engine cannot start. Do not smoke or allow sources of spark or open flame in the area while servicing. Keep the work area well ventilated and avoid prolonged exposure to vapors. Always check for leaks before attempting to start the engine, and wipe up any spilled fuel immediately.

1. Loosen main jet plugs with 1 turn on side of carburetors to drain fuel.

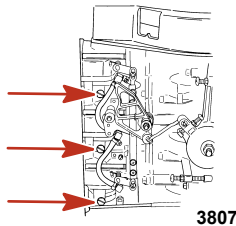

2. Dispose of fuel properly.



# MAINTENANCE

## FUEL LINE INSPECTION

Visually inspect the fuel line and primer bulb for cracks, swelling, leaks, hardness, or other signs of deterioration or damage. If any of these conditions are found, the fuel line or primer bulb must be replaced.

## CARBURETOR ADJUSTMENTS

### Slow Speed Mixture Adjustment

1. Before starting engine, turn the slow speed mixture screw in until it is lightly seated then back it out 1-1/4 turns.

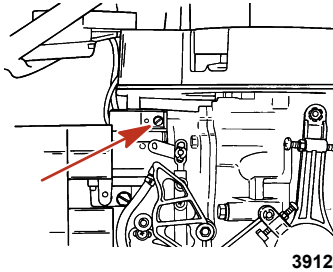

2. With boat tied securely to dock, start engine and allow it to warm up.
3. Shift the outboard into forward gear while maintaining idle speed.

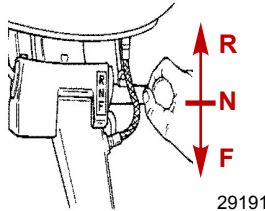

4. Turn the slow speed mixture screw slowly in until the engine starts to misfire or stall due to a lean mixture. Note the position of the screw slot.
5. Turn the slow speed mixture screw slowly out until the engine starts to load up or fire unevenly due to a rich mixture. Note the position of the screw slot.
6. Set the slow speed mixture screw midway between the rich and lean setting. When in doubt, set the mixture slightly rich rather than too lean.

### Engine Idle Speed Adjustment

1. With boat tied securely to dock, start engine and allow it to warm up.
2. Shift the outboard into forward gear while maintaining idle speed.

# MAINTENANCE

3. Adjust the idle speed screw to obtain the recommended engine idle speed. Refer to **General Information - Specifications**.

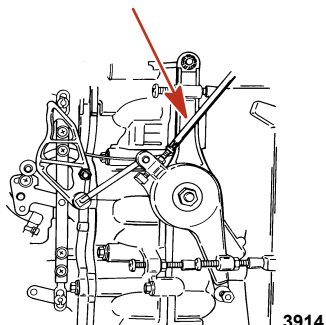

## High Speed Mixture Adjustment

The carburetor is equipped with a standard size high speed fixed jet that is replaceable for operation at higher elevations. See an authorized dealer.

## Steering Link Rod Fasteners

**IMPORTANT:** The steering link rod that connects the steering cable to the engine must be fastened using special washer head bolt ("d" - Part Number 10-856680) and self-locking nylon insert locknuts ("a" & "c" - Part Number 11-826709113). These locknuts must never be replaced with common nuts (non-locking) as they will work loose and vibrate off, freeing the link rod to disengage.

# MAINTENANCE

## ⚠ WARNING

Improper fasteners or improper installation procedures can result in loosening or disengagement of the steering link rod. This can cause a sudden, unexpected loss of boat control, resulting in serious injury or death due to occupants being thrown within or out of the boat. Always use required components and follow instructions and torque procedures.

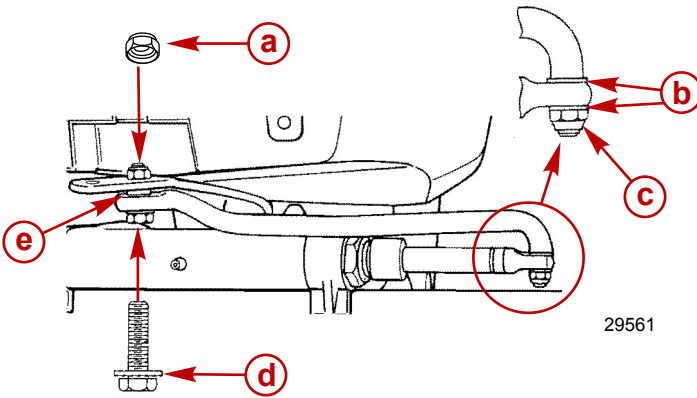

29561

- a** - Nylon insert locknut (11-826709113)
- b** - Flat washers
- c** - Nylon insert locknut (11-826709113)
- d** - Special washer head bolt (10-856680)
- e** - Spacer

Description	Nm	lb. in.	lb. ft.
Special washer head bolt	27		20
Nylon insert locknut "a"	27		20
Nylon insert locknut "c"	Tighten until seats, then back off 1/4 turn		

Assemble steering link rod to steering cable with two flat washers and nylon insert locknut. Tighten locknut until it seats, then back nut off 1/4 turn.

Assemble steering link rod to engine with special washer head bolt, locknut and spacer. First torque special washer head bolt, then torque locknut to specifications.

## Fuse Replacement

**IMPORTANT:** Always carry spare SFE 20-amp fuses.

# MAINTENANCE

The electric starting circuit is protected from overload by an SFE 20-amp fuse. If the fuse is blown, the electric starter motor will not operate. Try to locate and correct the cause of the overload. If the cause is not found, the fuse may blow again. Replace fuse with a fuse of the same rating.

Open the fuse holder and look at the silver colored band inside the fuse. If band is broken, replace the fuse with a new fuse with the same rating.

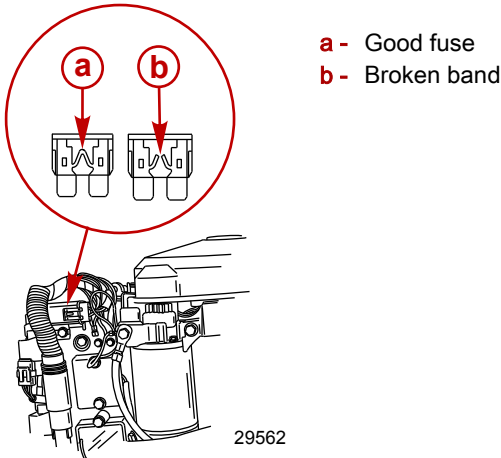

## Corrosion Control Anode

The outboard has corrosion control anodes at different locations. An anode helps protect the outboard against galvanic corrosion by sacrificing its metal to be slowly eroded instead of the outboard metals.

Each anode requires periodic inspection, especially in salt water which will accelerate the erosion. To maintain this corrosion protection, always replace the anode before it is completely eroded. Never paint or apply a protective coating on the anode as this will reduce effectiveness of the anode.

# MAINTENANCE

One anode is installed on the bottom of the transom bracket assembly. The trim tab is also an anode on the 87.3 mm (3 - 7/16 in.) diameter gearcase. The 108mm (4 - 1/4 in.) diameter gearcase has three anodes. One of the anodes is the trim tab, and the other two anodes are located on each side of the gearcase.

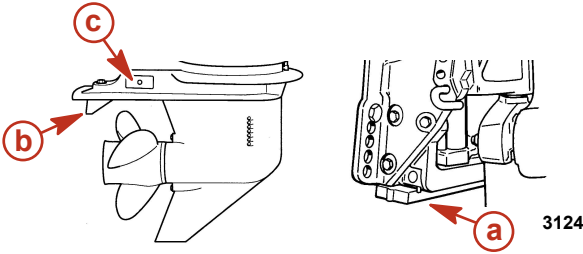

- a** - Transom bracket anode
- b** - Trim Tab
- c** - Anode on each side of gearcase

## Propeller Replacement—Standard Gearcase

### ▲ WARNING

Rotating propellers can cause serious injury or death. Never operate the boat out of the water with a propeller installed. Before installing or removing a propeller, place the drive unit in neutral and engage the lanyard stop switch to prevent the engine from starting. Place a block of wood between the propeller blade and the anti-ventilation plate.

1. Shift outboard to neutral (N) position.

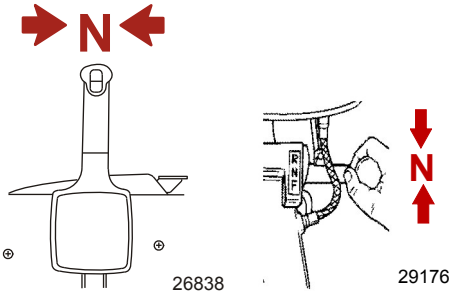

# MAINTENANCE

2. Remove the spark plug leads to prevent engine from starting.

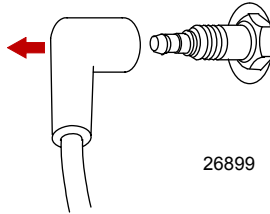

3. Straighten the bent tabs on the propeller nut retainer.

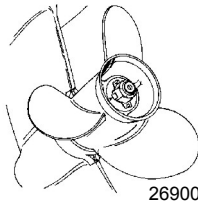

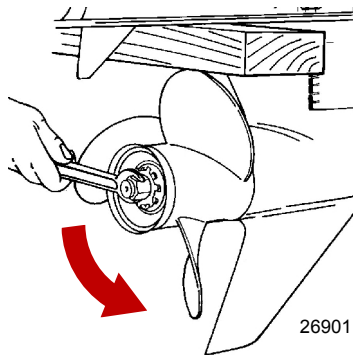

4. Place a block of wood between the gearcase and propeller to hold the propeller and remove the propeller nut.



5. Pull propeller straight off shaft. If propeller is seized to the shaft and cannot be removed, have the propeller removed by an authorized dealer.
6. Coat the propeller shaft with Extreme Grease or 2-4-C with PTFE.

# MAINTENANCE

Tube Ref No.	Description	Where Used	Part No.
	Extreme Grease	Propeller shaft	8M0071842
	2-4-C with PTFE	Propeller shaft	92-802859A 1

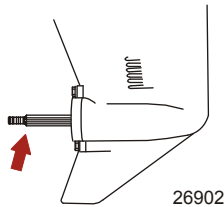

**IMPORTANT:** To prevent the propeller hub from corroding and seizing to the propeller shaft (especially in saltwater), always apply a coat of the recommended lubricant to the entire propeller shaft at the recommended maintenance intervals, and also each time the propeller is removed.

7. Flo-Torq I drive hub propellers - Install forward thrust hub, propeller, propeller nut retainer, and propeller nut onto the shaft.

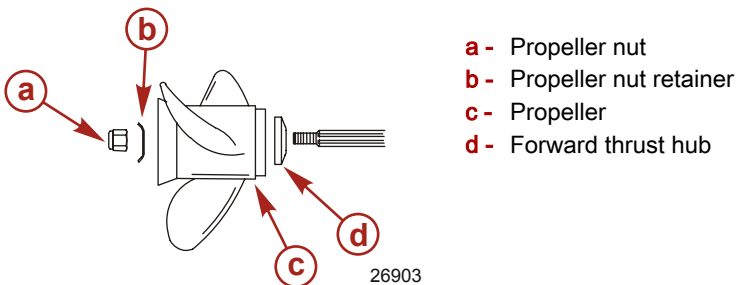

8. Flo-Torq II drive hub propellers - Install forward thrust hub, propeller, replaceable drive sleeve, rear thrust hub, propeller nut retainer, and propeller nut onto the shaft.

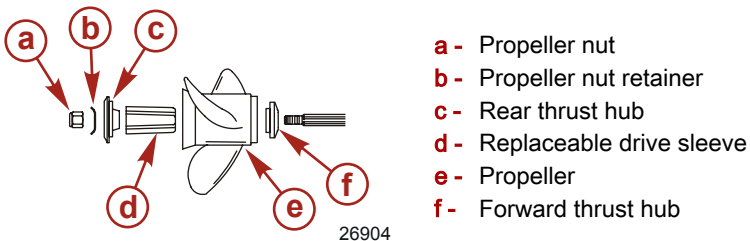

9. Place the propeller nut retainer over the pins. Place a block of wood between the gearcase and propeller and tighten the propeller nut to the specified torque. Align flat sides of the propeller nut with tabs on the propeller nut retainer.

# MAINTENANCE

Description	Nm	lb-in.	lb-ft
Propeller nut	75	-	55

10. Secure propeller nut by bending tabs up and against the flats on the propeller nut.

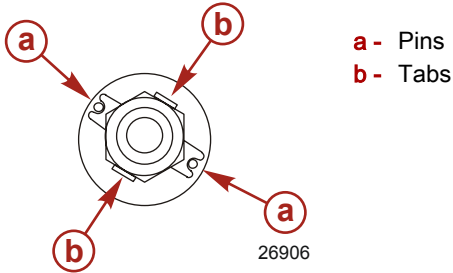

11. Install the spark plug leads.

## Propeller Replacement–Command Thrust Gearcase

### ⚠ WARNING

Rotating propellers can cause serious injury or death. Never operate the boat out of the water with a propeller installed. Before installing or removing a propeller, place the drive unit in neutral and engage the lanyard stop switch to prevent the engine from starting. Place a block of wood between the propeller blade and the anti-ventilation plate.

1. Shift outboard to neutral (N) position.

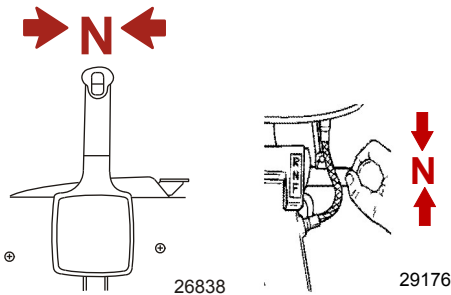



# MAINTENANCE

2. Remove the spark plug leads to prevent engine from starting.

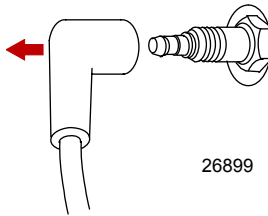

3. Straighten the bent tabs on the propeller nut retainer.

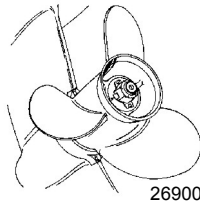

4. Place a block of wood between the gearcase and propeller to hold the propeller and remove the propeller nut.

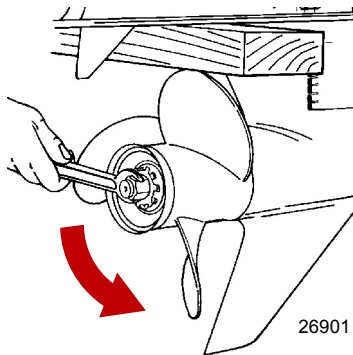

5. Pull propeller straight off shaft. If propeller is seized to the shaft and cannot be removed, have the propeller removed by an authorized dealer.
6. Coat the propeller shaft with Extreme Grease or 2-4-C with PTFE.

# MAINTENANCE

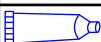
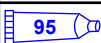
Tube Ref No.	Description	Where Used	Part No.
	Extreme Grease	Propeller shaft	8M0071842
	2-4-C with PTFE	Propeller shaft	92-802859A 1

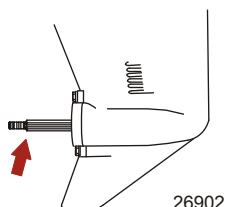

**IMPORTANT:** To prevent the propeller hub from corroding and seizing to the propeller shaft (especially in saltwater), always apply the recommended lubricant to the entire propeller shaft at the recommended maintenance intervals, and also each time the propeller is removed.

7. Flo-Torq I drive hub propellers - Install forward thrust hub, propeller, continuity washer, rear thrust hub, propeller nut retainer, and propeller nut onto the shaft.

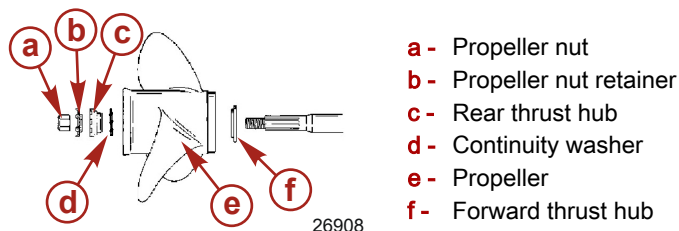

8. Flo-Torq II drive hub propellers - Install forward thrust hub, replaceable drive sleeve, propeller, rear thrust hub, propeller nut retainer, and propeller nut onto the shaft.

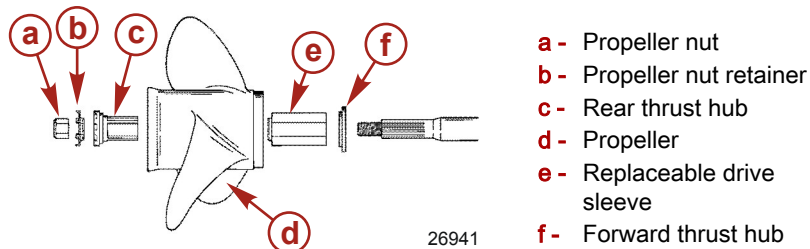

9. Place a block of wood between the gearcase and propeller and tighten the propeller nut to the specified torque.

# MAINTENANCE

Description	Nm	lb-in.	lb-ft
Propeller nut	75	–	55

- Secure propeller nut by bending tabs up and against the flats on the propeller nut.

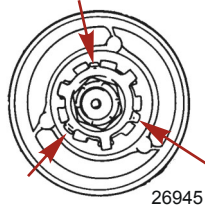

- Install the spark plug leads.

## Spark Plug Inspection and Replacement

### ⚠ WARNING

Damaged spark plug boots may emit sparks that can ignite fuel vapors under the engine cowl, resulting in serious injury or death from a fire or explosion. To avoid damaging the spark plug boots, do not use any sharp object or metal tool to remove the spark plug boots.

- Remove the spark plug boots. Twist the rubber boots slightly and pull off.

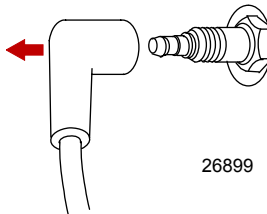

- Remove the spark plugs to inspect. Replace spark plug if electrode is worn or the insulator is rough, cracked, broken, blistered, or fouled.

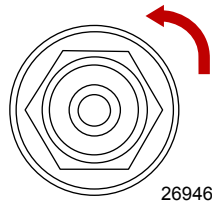

# MAINTENANCE

- Set the spark plug gap to specification.

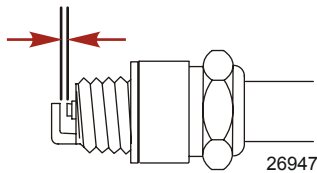



Spark Plug	
Spark plug gap	1.0 mm (0.040 in.)

- Before installing spark plugs, clean off any dirt on the spark plug seats. Install plugs finger-tight, and then tighten 1/4 turn or torque to specifications.

Description	Nm	lb-in.	lb-ft
Spark plug	27		20

## Lubrication Points

- Lubricate the following with Extreme Grease or 2-4-C with PTFE.

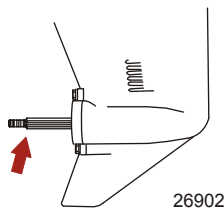

Tube Ref No.	Description	Where Used	Part No.
	Extreme Grease	Propeller shaft	8M0071842
	2-4-C with PTFE	Propeller shaft	92-802859A 1

- Propeller shaft - Refer to **Propeller Replacement** for removal and installation of the propeller. Coat the entire propeller shaft with lubricant to prevent the propeller hub from corroding and seizing to the shaft.



- Lubricate the following with Quicksilver or Mercury Precision Lubricants 2-4-C with PTFE or Extreme Grease.

# MAINTENANCE

Tube Ref No.	Description	Where Used	Part No.
 95	2-4-C with PTFE	Swivel bracket, tilt support lever, tilt tube, tiller handle, steering cable grease fitting	92-802859A 1
	Extreme Grease	Swivel bracket, tilt support lever, tilt tube, tiller handle, steering cable grease fitting	8M0071842

- Swivel bracket - Lubricate through fitting.
- Tilt support lever - Lubricate through fitting.

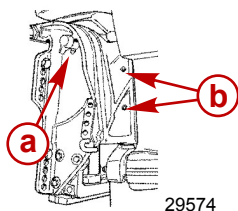

- a** - Tilt support lever
- b** - Swivel bracket

- Tilt tube - Lubricate through fitting.

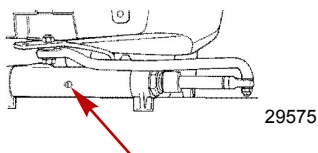

- Tiller handle - Lubricate through fitting.

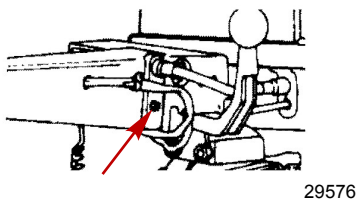

- Steering cable - Rotate steering wheel to fully retract the steering cable end into the outboard tilt tube. Lubricate through fitting.

# MAINTENANCE

## ▲ WARNING

Incorrect cable lubrication can cause hydraulic lock, leading to serious injury or death from loss of boat control. Completely retract the end of the steering cable before applying lubricant.

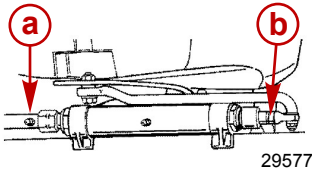

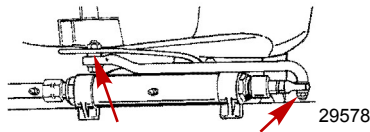

- a - Fitting
- b - Steering cable end

3. Lubricate the following with lightweight oil.
  - Steering link rod pivot points - Lubricate pivot points.



## Lubrication Points—Sea Pro/Marathon Models

1. Lubricate the following with Extreme Grease or 2-4-C with PTFE.

Tube Ref No.	Description	Where Used	Part No.
	Extreme Grease	Propeller shaft, swivel bracket, tilt support lever, tilt tube, tiller handle, clamp screw threads	8M0071842
	2-4-C with PTFE	Propeller shaft, swivel bracket, tilt support lever, tilt tube, tiller handle, clamp screw threads	92-802859A 1

- Propeller shaft - Refer to **Propeller Replacement** for removal and installation of the propeller. Coat the entire propeller shaft with lubricant to prevent the propeller hub from corroding and seizing to the shaft.

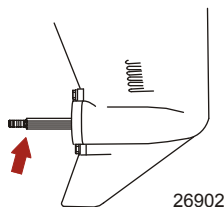

- Swivel bracket - Lubricate through fitting.

# MAINTENANCE

- Tilt support lever - Lubricate through fitting.

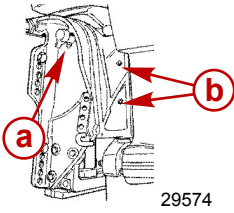

- a** - Tilt support lever
- b** - Swivel bracket

- Tilt tube - Lubricate through fitting.

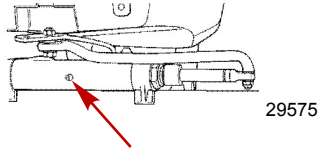

- Tiller handle - Lubricate through fitting.

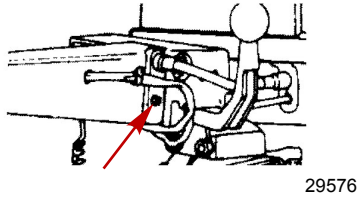

- Clamp screw threads.

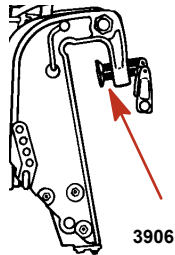

# MAINTENANCE

## Checking Power Trim Fluid

1. Tilt outboard to the full up position and engage the tilt support lock.

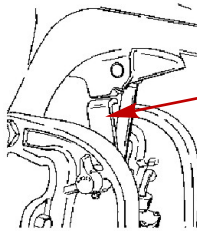

26967

2. Remove fill cap and check fluid level. The fluid level should be even with the bottom of the fill hole. Add Quicksilver or Mercury Precision Lubricants Power Trim and Steering Fluid. If not available, use automotive automatic transmission fluid (ATF).

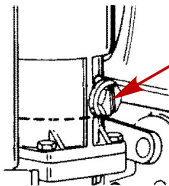

29588

Tube Ref No.	Description	Where Used	Part No.
 114	Power Trim and Steering Fluid	Power Trim	92-858074K01

## Gearcase Lubrication

When adding or changing gearcase lubricant, visually check for the presence of water in the lubricant. If water is present, it may have settled to the bottom and will drain out prior to the lubricant, or it may be mixed with the lubricant, giving it a milky colored appearance. If water is noticed, have the gearcase checked by your dealer. Water in the lubricant may result in premature bearing failure or, in freezing temperatures, will turn to ice and damage the gearcase.

Remove the fill/drain plug and examine the lubricant draining from the gearcase for metal particles. A small amount of metal filings or fine metal particles indicates normal gear wear. An excessive amount of metal filings or larger particles (chips) may indicate abnormal gear wear and should be checked by an authorized dealer.

## DRAINING GEARCASE

1. Place the outboard in a vertical operating position.



# MAINTENANCE

2. Place a drain pan below the outboard.
3. Remove the vent plugs and fill/drain plug and drain the lubricant.

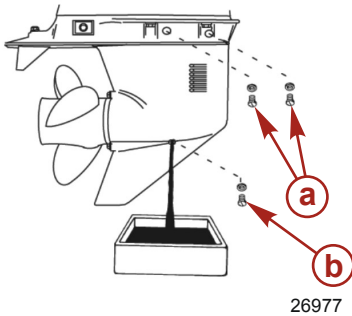

- a - Vent plugs
- b - Fill/drain plug

## GEARCASE LUBRICANT CAPACITY

Standard gearcase—approximately 340 ml (11.5 fl oz).

Command Thrust gearcase—approximately 666 ml (22.5 fl oz).

## GEARCASE LUBRICANT RECOMMENDATION

Mercury or Quicksilver Premium or High Performance Gear Lubricant.

## CHECKING LUBRICANT LEVEL AND FILLING GEARCASE

1. Place the outboard in a vertical operating position.
2. Remove the front vent plug and rear vent plug.
3. Remove the fill/drain plug. Place the lubricant tube into the fill/drain plug hole and add lubricant until it appears at the front vent hole. At this time install the front vent plug and sealing washer.

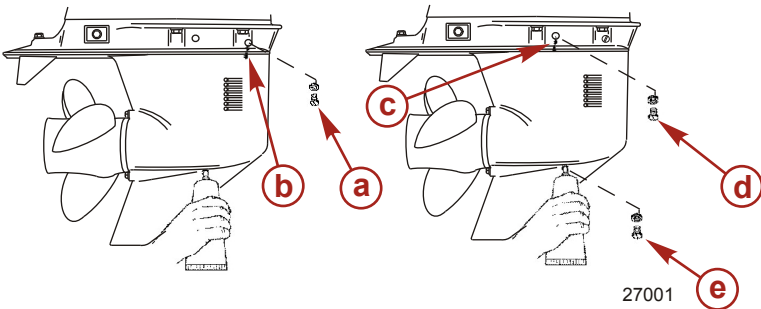

- a - Front vent plug
- b - Front vent hole
- c - Rear vent hole
- d - Rear vent plug
- e - Fill/drain plug

# MAINTENANCE

4. Continue adding the lubricant until it appears at the rear vent hole.
5. Stop adding the lubricant. Install the rear vent plug and sealing washer before removing lubricant tube.
6. Remove the lubricant tube and install cleaned fill/drain plug and sealing washer.

## **Submerged Outboard**

A submerged outboard will require service within a few hours by an authorized dealer once the outboard is recovered from the water. This immediate attention by a servicing dealer is necessary once the engine is exposed to the atmosphere to minimize internal corrosion damage to the engine.

# STORAGE

## Storage Preparation

The major consideration in preparing your outboard for storage is to protect it from rust, corrosion, and damage caused by freezing of trapped water.

The following storage procedures should be followed to prepare your outboard for out of season storage or prolonged storage (two months or longer).

### NOTICE

**Without sufficient cooling water, the engine, the water pump, and other components will overheat and suffer damage. Provide a sufficient supply of water to the water inlets during operation.**

## FUEL SYSTEM

**IMPORTANT: Gasoline containing alcohol (ethanol or methanol) can cause a formation of acid during storage and can damage the fuel system. If the gasoline being used contains alcohol, it is advisable to drain as much of the remaining gasoline as possible from the fuel tank, remote fuel line, and engine fuel system.**

Fill the fuel tank and engine fuel system with treated (stabilized) fuel to help prevent formation of varnish and gum. Proceed with the following instructions.

- Portable fuel tank - Pour the required amount of gasoline stabilizer (follow instructions on container) into fuel tank. Tip fuel tank back and forth to mix stabilizer with the fuel.
- Permanently installed fuel tank - Pour the required amount of gasoline stabilizer (follow instructions on container) into a separate container and mix with approximately 1 liter (1 U.S. quart) of gasoline. Pour this mixture into fuel tank.
- Place the outboard in water or connect flushing attachment for circulating cooling water. Run the engine for ten minutes to fill the engine fuel system.

Flushing Device	91-44357Q 2
 <p>9192</p>	<p>Attaches to the water intakes; provides a fresh water connection when flushing the cooling system or operating the engine.</p>

## Protecting External Outboard Components

- Lubricate all outboard components listed in **Maintenance - Inspection and Maintenance Schedule**.

# STORAGE

- Touch up any paint nicks. See your dealer for touch-up paint.
- Spray Quicksilver or Mercury Precision Lubricants Corrosion Guard on external metal surfaces (except corrosion control anodes).

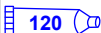
Tube Ref No.	Description	Where Used	Part No.
 120	Corrosion Guard	External metal surfaces	92-802878 55

## Protecting Internal Engine Components

**NOTE:** Make sure the fuel system has been prepared for storage. Refer to **Fuel System**, preceding.

**IMPORTANT:** Refer to **Maintenance - Spark Plug Inspection and Replacement** for correct procedure for removing spark plug boots.

- Place the outboard in water or connect flushing attachment for circulating cooling water. Start the engine and let it run in neutral to warm up.
- With engine running at fast idle, stop the fuel flow by disconnecting the remote fuel line. When engine begins to stall, quickly spray Quicksilver or Mercury Precision Lubricants Storage Seal into carburetor until engine stops from lack of fuel.
- Remove the spark plugs and inject a five second spray of storage seal around the inside of the cylinder.
- Rotate the flywheel manually several times to distribute the storage seal in the cylinder. Reinstall spark plug.

## Gearcase

- Drain and refill the gearcase lubricant (refer to **Gearcase Lubrication**).

## Positioning Outboard for Storage

Store outboard in an upright (vertical) position to allow water to drain out of the outboard.

### NOTICE

Storing the outboard in a tilted position can damage the outboard. Water trapped in the cooling passages or rain water collected in the propeller exhaust outlet in the gearcase can freeze. Store the outboard in the full down position.

## Battery Storage

- Follow the battery manufacturer's instructions for storage and charging.
- Remove the battery from the boat and check water level. Charge if necessary.
- Store the battery in a cool, dry place.
- Periodically check the water level and charge the battery during storage.

# TROUBLESHOOTING

## Starter Motor Will Not Crank the Engine (Electric Start Models)

### POSSIBLE CAUSES

- Remote control models - Blown 20 amp fuse in the starting circuit. Refer to **Maintenance** section.
- Outboard is not shifted to neutral position.
- Weak battery or battery connections are loose or corroded.
- Ignition key switch failure.
- Wiring or electrical connection faulty.
- Starter motor or starter solenoid failure.

## Engine Will Not Start

### POSSIBLE CAUSES

- Lanyard stop switch not in "RUN" position.
- Incorrect starting procedure. Refer to **Operation** section.
- Old or contaminated gasoline.
- Engine flooded. Refer to **Operation** section.
- Fuel is not reaching the engine.
  - a. Fuel tank is empty.
  - b. Fuel tank vent not open or restricted.
  - c. Fuel line is disconnected or kinked.
  - d. Primer bulb not squeezed.
  - e. Primer bulb check valve is faulty.
  - f. Fuel filter is obstructed. Refer to **Maintenance** section.
  - g. Fuel pump failure.
  - h. Fuel tank filter obstructed.
- Ignition system component failure.
- Spark plugs fouled or defective. Refer to **Maintenance** section.

## Engine Runs Erratically

### POSSIBLE CAUSES

- Spark plugs fouled or defective. Refer to **Maintenance** section.
- Incorrect setup and adjustments.
- Fuel is being restricted to the engine.
  - Engine fuel filter is obstructed. Refer to **Maintenance** section.
  - Fuel tank filter obstructed.
  - Stuck anti-siphon valve on built in fuel tank.
  - Fuel line is kinked or pinched.
- Fuel pump failure.

# TROUBLESHOOTING

- Ignition system component failure.

## **Performance Loss**

### **POSSIBLE CAUSES**

- Throttle not fully open.
- Damaged or improper size propeller.
- Incorrect engine timing, adjustments, or setup.
- Boat overloaded or load improperly distributed.
- Excessive water in bilge.
- Boat bottom is dirty or damaged.

## **Battery Will Not Hold Charge**

### **POSSIBLE CAUSES**

- Battery connections are loose or corroded.
- Low electrolyte level in battery.
- Worn out or inefficient battery.
- Excessive use of electrical accessories.
- Defective rectifier, alternator, or voltage regulator.

# OWNER SERVICE ASSISTANCE

## Local Repair Service

Always return your outboard to your local authorized dealer should the need for service arise. Only he has the factory trained mechanics, knowledge, special tools, equipment, and genuine parts and accessories to properly service your engine should the need occur. He knows your engine best.

## Service Away from Home

If you are away from your local dealer and the need arises for service, contact the nearest authorized dealer. Refer to the Yellow Pages of the telephone directory. If, for any reason, you cannot obtain service, contact the nearest Mercury Marine Service Office.

## Parts and Accessories Inquiries

All inquiries concerning genuine replacement parts and accessories should be directed to your local authorized dealer. The dealer has the necessary information to order parts and accessories for you. When inquiring about parts and accessories, the dealer requires the model and serial number to order the correct parts.

## Service Assistance

### LOCAL REPAIR SERVICE

If you need service for your Mercury-outboard-powered boat, take it to your authorized dealer. Only authorized dealers specialize in Mercury products and have factory-trained mechanics, special tools and equipment, and genuine Quicksilver parts and accessories to properly service your engine.

**NOTE:** *Quicksilver parts and accessories are engineered and built by Mercury Marine specifically for your power package.*

### SERVICE AWAY FROM HOME

If you are away from your local dealer and the need arises for service, contact the nearest authorized dealer. If, for any reason, you cannot obtain service, contact the nearest Regional Service Center. Outside the United States and Canada, contact the nearest Marine Power International Service Center.

### STOLEN POWER PACKAGE

If your power package is stolen, immediately advise the local authorities and Mercury Marine of the model and serial numbers and to whom the recovery is to be reported. This information is maintained in a database at Mercury Marine to aid authorities and dealers in the recovery of stolen power packages.

### ATTENTION REQUIRED AFTER SUBMERSION

1. Before recovery, contact an authorized Mercury dealer.
2. After recovery, immediate service by an authorized Mercury dealer is required to reduce the possibility of serious engine damage.

# OWNER SERVICE ASSISTANCE

## REPLACEMENT SERVICE PARTS

### WARNING

Avoid fire or explosion hazard. Electrical, ignition, and fuel system components on Mercury Marine products comply with federal and international standards to minimize risk of fire or explosion. Do not use replacement electrical or fuel system components that do not comply with these standards. When servicing the electrical and fuel systems, properly install and tighten all components.

Marine engines are expected to operate at or near full throttle for most of their lives. They are also expected to operate in both fresh and saltwater environments. These conditions require numerous special parts.

## PARTS AND ACCESSORIES INQUIRIES

Direct any inquiries concerning Quicksilver replacement parts and accessories to your local authorized dealer. The dealer has the necessary information to order parts and accessories for you if they are not in stock. Only authorized dealers can purchase genuine Quicksilver parts and accessories from the factory. Mercury Marine does not sell to unauthorized dealers or retail customers. When inquiring about parts and accessories, the dealer requires the **engine model** and **serial numbers** to order the correct parts.

## RESOLVING A PROBLEM

Satisfaction with your Mercury product is important to your dealer and to us. If you ever have a problem, question or concern about your power package, contact your dealer or any authorized Mercury dealership. If you need additional assistance:

1. Talk with the dealership's sales manager or service manager. Contact the owner of the dealership if the sales manager and service manager have been unable to resolve the problem.
2. If your question, concern, or problem cannot be resolved by your dealership, please contact the Mercury Marine Service Office for assistance. Mercury Marine will work with you and your dealership to resolve all problems.

The following information will be needed by the Customer Service:

- Your name and address
- Your daytime telephone number
- The model and serial numbers of your power package
- The name and address of your dealership
- The nature of the problem



# OWNER SERVICE ASSISTANCE

## CONTACT INFORMATION FOR MERCURY MARINE CUSTOMER SERVICE

For assistance, call, fax, or write to the geographic office in your area. Please include your daytime telephone number with mail and fax correspondence.

<b>United States, Canada</b>		
Telephone	English +1 920 929 5040 Français +1 905 636 4751	Mercury Marine W6250 Pioneer Road P.O. Box 1939 Fond du Lac, WI 54936-1939
Fax	English +1 920 929 5893 Français +1 905 636 1704	
Website	www.mercurymarine.com	

<b>Australia, Pacific</b>		
Telephone	+61 3 9791 5822	Brunswick Asia Pacific Group 41-71 Bessemer Drive Dandenong South, Victoria 3175 Australia
Fax	+61 3 9706 7228	

<b>Europe, Middle East, Africa</b>		
Telephone	+32 87 32 32 11	Brunswick Marine Europe Parc Industriel de Petit-Rechain B-4800 Verviers, Belgium
Fax	+32 87 31 19 65	

<b>Mexico, Central America, South America, Caribbean</b>		
Telephone	+1 954 744 3500	Mercury Marine 11650 Interchange Circle North Miramar, FL 33025 U.S.A.
Fax	+1 954 744 3535	

<b>Japan</b>		
Telephone	+072 233 8888	Kisaka Co., Ltd. 4-130 Kannabecho, Sakai-ku Sakai-shi, Osaka 590-0984, Japan
Fax	+072 233 8833	

<b>Asia, Singapore</b>		
Telephone	+65 65466160	Brunswick Asia Pacific Group T/A Mercury Marine Singapore Pte Ltd 29 Loyang Drive Singapore, 508944
Fax	+65 65467789	

# OWNER SERVICE ASSISTANCE

## Ordering Literature

Before ordering literature, have the following information about your power package available:

Model		Serial Number	
Horsepower		Year	

## UNITED STATES AND CANADA

For additional literature for your Mercury Marine power package, contact your nearest Mercury Marine dealer or contact:

Mercury Marine		
Telephone	Fax	Mail
(920) 929-5110 (USA only)	(920) 929-4894 (USA only)	Mercury Marine Attn: Publications Department P.O. Box 1939 Fond du Lac, WI 54936-1939

## OUTSIDE THE UNITED STATES AND CANADA

Contact your nearest Mercury Marine authorized service center to order additional literature that is available for your particular power package.

Submit the following order form with payment to:	Mercury Marine Attn: Publications Department W6250 Pioneer Road P.O. Box 1939 Fond du Lac, WI 54936-1939
<b>Ship To: (Copy this form and print or type—This is your shipping label)</b>	
<b>Name</b>	
<b>Address</b>	
<b>City, State, Province</b>	
<b>ZIP or postal code</b>	
<b>Country</b>	

Quantity	Item	Stock Number	Price	Total
			.	.
			.	.
			.	.
			.	.

# OWNER SERVICE ASSISTANCE

Quantity	Item	Stock Number	Price	Total
			.	.
Total Due				.

# INSTALLATION

## Mercury Marine Validated Engine Mounting Hardware

**IMPORTANT:** Mercury Marine provides validated fasteners and installation instructions, including torque specifications, with all of our outboards so they can be properly secured to boat transoms. Improper installation of the outboard can cause performance and reliability issues that can lead to safety concerns. Follow all of the instructions relating to the outboard installation. **DO NOT** mount any other accessory onto the boat with the fasteners provided with the outboard. For example, do not mount a tow sport bars or boarding ladders onto the boat using the mounting hardware included with the outboard. Installing other products onto the boat that utilize the outboard mounting hardware will compromise the ability of that hardware to properly and safely secure the outboard to the transom.

Outboards that require validated mounting hardware will have the following decal on the transom clamp.



51965

## Accessories Mounted to the Transom Clamp Bracket

Mercury Marine has been made aware that certain aftermarket marine accessories, such as emergency boarding ladders, shallow water anchors, transom wedge kits, and tow sport attaching devices, have been mounted to the boat by use of the same fasteners that secure the outboard to the transom or jack plate. Using the same fastener to secure both an accessory and the engine to the boat compromises the ability of the fasteners to maintain the proper clamp load. A boat with loose engine mounting fasteners creates the possibility of performance, durability, and safety issues.

# INSTALLATION

## **⚠ WARNING**

**Avoid serious injury or death resulting from a loss of boat control. Loose engine fasteners could cause the transom bracket to fail, resulting in a loss of the driver's ability to control the boat. Always ensure that the engine fasteners are tightened to the specified torque.**

### **ACCEPTABLE ACCESSORY MOUNTING TO THE TRANSOM CLAMP BRACKET**

After the engine is mounted to the transom or jack plate in accordance with the engine installation instructions, it is acceptable to attach an accessory to the boat by use of the unused bolt holes in the transom clamp bracket as shown in Figure 1.

The following list provides additional guidelines for mounting accessories to the transom clamp bracket.

- The accessory fasteners must pass through the boat transom or jack plate.

# INSTALLATION

- The installation must not create interference issues, as would an accessory mounting plate resting in the radius of the transom clamp bracket. Refer to Figure 1.

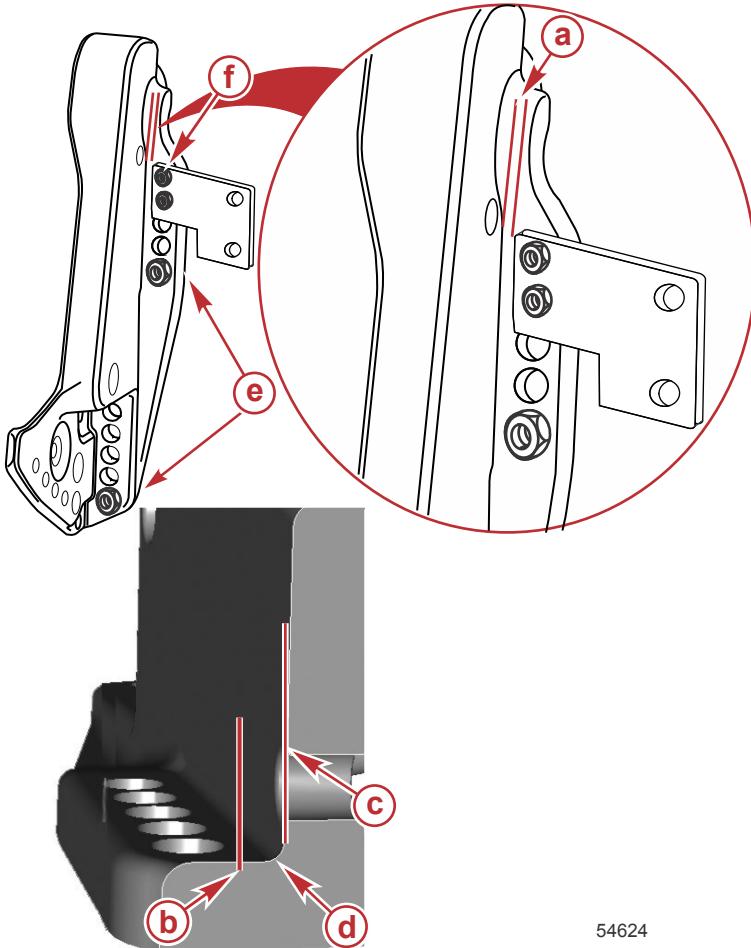

54624

**Figure 1**

- a** - Minimum clearance 3.175 mm (0.125 in.)
- b** - Edge of accessory bracket
- c** - Transom clamp bracket wall
- d** - Radius
- e** - Engine supplied mounting fasteners
- f** - Fasteners supplied by the accessory manufacturer installed through unused engine mounting bracket holes

# INSTALLATION

## UNACCEPTABLE ACCESSORY MOUNTING

**IMPORTANT:** Do not use the fasteners that secure the engine to the boat (either the transom or the jack plate) for any purpose other than securing the engine to the boat.

1. Do not mount an accessory to the transom clamp bracket in an unsupported condition. Refer to Figure 2.

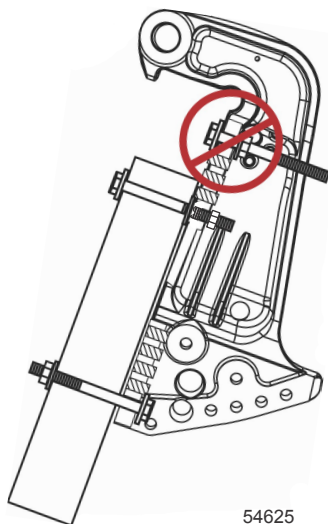

**Figure 2**

2. Do not attach an accessory to the boat by use of the engine mounting hardware. Refer to Figure 3.

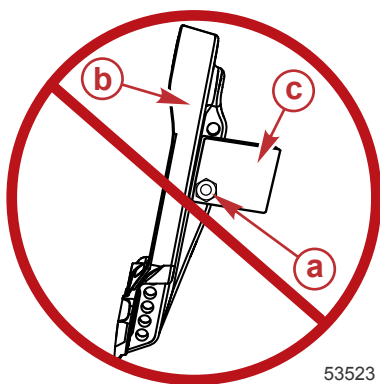
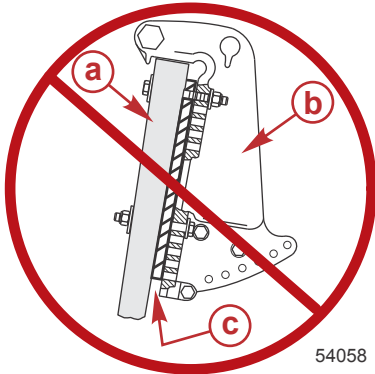

**Figure 3**

- a - Engine supplied mounting fasteners
- b - Transom clamp bracket
- c - Accessory

# INSTALLATION

3. Do not install wedges or plates between the transom clamp brackets and the transom (or jack plate). Refer to Figure 4.



**Figure 4**

- a** - Boat transom or jack plate
- b** - Transom clamp bracket
- c** - Wedge/plate

## Installing Outboard

### **▲ WARNING**

**Failure to correctly fasten the outboard could result in the outboard propelling off the boat transom resulting in property damage, serious injury, or death. Before operation, the outboard must be correctly installed with the required mounting hardware.**

We strongly recommend that your dealer install your outboard and related accessories to ensure proper installation and good performance. If you install the outboard yourself, follow instructions in the outboard installation manual which is provided with the outboard.



# INSTALLATION

## MODELS WITHOUT TRANSOM BRACKET CLAMP SCREWS

The outboard must be secured to the transom with the four 12.7 mm (1/2 in.) diameter mounting bolts and locknuts provided. Install two bolts through the upper set of holes and two bolts through the lower set of holes.

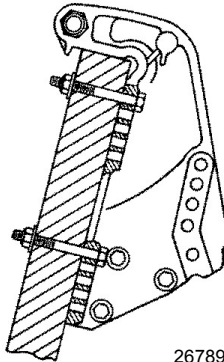

26789

## MODELS WITH TRANSOM BRACKET CLAMP SCREWS

The outboard must be secured to the transom one of two ways: EITHER with clamp screws and the four mounting bolts and locknuts provided, OR with clamp screws and optional Quicksilver or Mercury Precision Parts Outboard Mounting Kit.

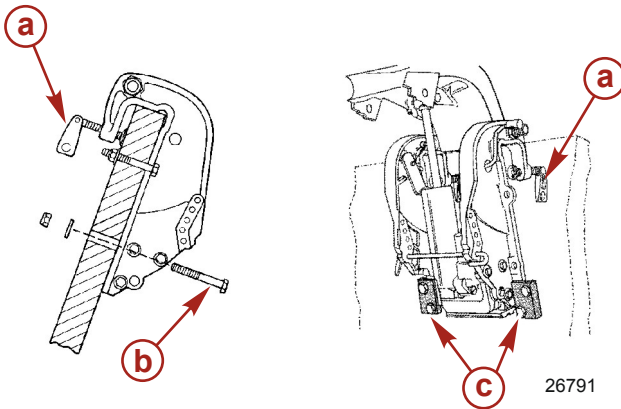

26791

- a** - Clamp screw
- b** - Mounting bolt and locknut (4)
- c** - Outboard Mounting Kit (part number 812432A4)

# INSTALLATION

## Propeller Selection

For best all around performance from your outboard/boat combination, select a propeller that allows the engine to operate in the upper half of the recommended full throttle RPM range with the boat normally loaded (refer to **General Information - Specifications**). This RPM range allows for better acceleration while maintaining maximum boat speed.

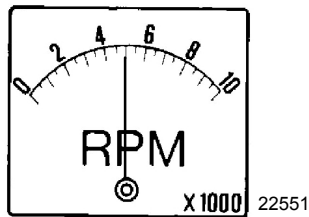

If changing conditions cause the RPM to drop below the recommended range (such as warmer, more humid weather, operation at higher elevations, increased boat load, or a dirty boat bottom/gearcase), a propeller change or cleaning may be required to maintain performance and ensure the outboards durability.

Check full-throttle RPM, using an accurate tachometer, with the engine trimmed out to a balanced-steering condition (steering effort equal in both directions) without causing the propeller to break loose.

## PROPELLER REQUIREMENTS—COMMAND THRUST MODELS

Command Thrust models require the use of specially designed rubber hub propellers to reduce both instances and severity of gearcase clutch rattle. The use of the other propellers, although not detrimental to either performance or durability, could result in clutch rattle.

# MAINTENANCE LOG

## Maintenance Log

Record all maintenance performed on your outboard here. Be sure to save all work orders and receipts.

Date	Maintenance Performed	Engine Hours