

Declaration of Conformity - For Recreational Craft Propulsion Engines with the Requirements of Directive 94/25/EC as amended by 2003/44/EC

90-8M0079567 313

Name of engine manufacturer: Tohatsu Marine Corporation (TMC) Mercury Marine Joint Venture		
Address: Shimodaira 4495-9		
Town: Komagane-City, Nagano	Post Code: 399-4101	Country: Japan

Name of Authorized Representative: Brunswick Marine in EMEA Inc.		
Address: Parc Industriel de Petit-Rechain		
Town: Verviers	Post Code: B-B-2800	Country: Belgium

Name of Notified Body for exhaust emission assessment: TÜV SÜD Group			
Address: Ridlerstrasse 65			
Town: Munich	Post Code: 80339	Country: Germany	ID Number: 0123

Name of Notified Body for noise emission assessment: International Marine Certification Institute			
Address: Rue Abbé Cuypers 3			
Town: Bruxelles	Post Code: B-1040	Country: Belgium	ID Number: 0609

Conformity assessment module used for exhaust emissions:	<input checked="" type="checkbox"/> B +C	<input type="checkbox"/> B +D	<input type="checkbox"/> B +E	<input type="checkbox"/> B +F	<input type="checkbox"/> G	<input type="checkbox"/> H
Conformity assessment module used for noise emissions:	<input type="checkbox"/> A	<input checked="" type="checkbox"/> Aa	<input type="checkbox"/> G	<input type="checkbox"/> H		
Other Community Directives applied: Safety of Machinery Directive 2006/42/EC; Electromagnetic Compatibility Directive 2004/108/EC						

Description of Engines and Essential Requirements

Engine Type	Fuel Type	Combustion Cycle
<input checked="" type="checkbox"/> Outboard engine	<input checked="" type="checkbox"/> Petrol	<input checked="" type="checkbox"/> 4 stroke

25 Jet FourStroke

© 2013 Mercury Marine

Identification of Engines Covered by This Declaration of Conformity

Name of engine model or engine family	Starting serial number	EC Type—examination certificate or type—approval certificate number
2.5, 3.5 hp	0R098000	SB5 09 01 57840 033
4, 5, 6 hp	0R098000	SB5 11 04 57840 037
15, 20 hp	0R235168	SB5 07 12 57840 027
25, 30 hp EFI	0R098000	SB5 05 10 57840 003

Essential requirements	Standards	Other normative document/method	Technical file	Please specify in more detail (* = mandatory standard)
Annex 1.B—Exhaust Emissions				
B.1 engine identification	<input type="checkbox"/>	<input type="checkbox"/>	<input checked="" type="checkbox"/>	
B.2 exhaust emission requirements	<input checked="" type="checkbox"/> *	<input type="checkbox"/>	<input type="checkbox"/>	* EN ISO 8178-1:1996
B.3 durability	<input type="checkbox"/>	<input type="checkbox"/>	<input checked="" type="checkbox"/>	
B.4 owner's manual	<input checked="" type="checkbox"/>	<input type="checkbox"/>	<input type="checkbox"/>	ISO 8665: 2006
Annex 1.C—Noise Emissions				
C.1 Noise emission levels	<input checked="" type="checkbox"/> *	<input type="checkbox"/>	<input type="checkbox"/>	EN ISO 14509
C.2 Owner's manual	<input type="checkbox"/>	<input checked="" type="checkbox"/>	<input type="checkbox"/>	Owner's manual

This declaration of conformity is issued under the sole responsibility of the manufacturer. I declare on behalf of the engine manufacturer that the engines mentioned preceding complies with all applicable essential requirements in the way specified.

Name / function:

Mark D. Schwabero, President,
Mercury Marine

**Date and place of issue:**

September 04, 2012
Fond du Lac, Wisconsin, USA

Welcome

You have selected one of the finest outboards available. It incorporates numerous design features to ensure operating ease and durability.

With proper care and maintenance, you will enjoy using this product for many boating seasons. To ensure maximum performance and carefree use, we ask that you thoroughly read this manual.

The Operation, Maintenance and Warranty Manual contains specific instructions for using and maintaining your product. We suggest that this manual remain with the product for ready reference whenever you are on the water.

Thank you for purchasing one of our products. We sincerely hope your boating will be pleasant!

Mercury Marine

EPA Emissions Regulations

Outboards sold by Mercury Marine in the United States are certified to the United States Environmental Protection Agency as conforming to the requirements of the regulations for the control of air pollution from new outboard motors. This certification is contingent on certain adjustments being set to factory standards. For this reason, the factory procedure for servicing the product must be strictly followed and, wherever practicable, returned to the original intent of the design.

Maintenance, replacement, or repair of the emission control devices and systems may be performed by any marine engine repair establishment or individual.

Engines are labeled with an emission control information decal as permanent evidence of EPA certification.

 **WARNING**

The engine exhaust from this product contains chemicals known to the state of California to cause cancer, birth defects or other reproductive harm.

Warranty Message

The product you have purchased comes with a limited warranty from Mercury Marine. The terms of the warranty are set forth in the **Warranty Information** section of this manual. The warranty statement contains a description of what is covered, what is not covered, the duration of coverage, how to best obtain warranty coverage, important disclaimers and limitations of damages, and other related information. Please review this information.

The description and specifications contained herein were in effect at the time this manual was approved for printing. Mercury Marine, whose policy is one of continued improvement, reserves the right to discontinue models at any time, and to change specifications, designs, methods, or procedures without notice and without incurring obligation.

Mercury Marine, Fond du Lac, Wisconsin U.S.A.

Printed in the U.S.A.

© 2013, Mercury Marine

Alpha, Axius, Bravo One, Bravo Two, Bravo Three, Circle M with Waves Logo, K-planes, Mariner, MerCathode, MerCruiser, Mercury, Mercury with Waves Logo, Mercury Marine, Mercury Precision Parts, Mercury Propellers, Mercury Racing, MotorGuide, OptiMax, Quicksilver, SeaCore, Skyhook, SmartCraft, Sport-Jet, Verado, VesselView, Zero Effort, Zeus, and #1 On the Water are registered trademarks of Brunswick Corporation. Mercury Product Protection is a registered service mark of Brunswick Corporation.

Mercury Premier Service

Mercury evaluates the service performance of its dealers and assigns its highest rating of "Mercury Premier" to those demonstrating an exceptional commitment to service.

Earning a Mercury Premier Service rating means a dealer:

- Achieves a high 12-month service Customer Satisfaction Index (CSI) score for warranty service.
- Possesses all of the necessary service tools, test equipment, manuals, and parts books.
- Employs at least one certified or master technician.
- Provides timely service for all Mercury Marine customers.
- Offers extended service hours and mobile service, when appropriate.
- Uses, displays, and stocks an adequate inventory of genuine Mercury Precision Parts.
- Offers a clean, neat shop with well-organized tools and service literature.

WARRANTY INFORMATION

Warranty Registration United States and Canada.....	1
Transfer of Warranty United States and Canada.....	1
Transfer of Mercury Product Protection (Extended Service Coverage) Plan United States and Canada.....	2
FourStroke Outboard Limited Warranty United States and Canada.....	3
3 Year Limited Warranty Against Corrosion.....	6
Warranty Coverage and Exclusions.....	10
U.S. EPA Emissions Limited Warranty.....	12
Emission Control System Components.....	12
California Emissions Limited Warranty.....	13
California Air Resources Board Explanation of Your California Emission Control Warranty Statement.....	17
Emission Certification Star Label.....	18
Warranty Policies Outside The United States and Canada.....	19

General Information

Boater's Responsibilities.....	33
Before Operating Your Outboard.....	33
Boat Horsepower Capacity.....	34
High-Speed and High-Performance Boat Operation.....	34
Outboard Remote Control Models	35
Remote Steering Notice.....	35
Lanyard Stop Switch.....	36
Protecting People In The Water.....	40
Wave and Wake Jumping.....	41
Safety Instructions for Hand-Tilled Outboards.....	41
Exhaust Emissions.....	42
Selecting Accessories for Your Outboard.....	45
Safe Boating Recommendations.....	45
Recording Serial Number.....	48
Specifications.....	49
Component Identification.....	50

Transporting

Trailer Boat/Outboard.....	53
----------------------------	----

Fuel and Oil

Fuel Recommendations.....	54
Low Permeation Fuel Hose Requirement	55
EPA Pressurized Portable Fuel Tank Requirements.....	56
Fuel Demand Valve (FDV) Requirement.....	56
Mercury Marine's Pressurized Portable Fuel Tank.....	57
Filling Fuel Tank.....	58
Engine Oil Recommendations.....	59
Checking And Adding Engine Oil.....	59

Features and Controls

Remote Control Features.....	62
Tiller Handle Models.....	63
Power Trim and Tilt (if Equipped).....	69
Warning System.....	72
Replaceable Jet Drive Shear Key.....	75

Operation

Pre-Starting Check List.....	76
Operating in Freezing Temperatures.....	76
Operating in Saltwater or Polluted Water.....	77
Operating in Shallow Water.....	77
How the Jet Drive Operates.....	77
Stopping the Boat in an Emergency.....	79
Steering the Boat.....	79
Mooring the Boat.....	80
Water Intake Blockage.....	81
Clearing A Lodged Impeller.....	81
Pre-Starting Instructions.....	82
Engine Break-in Procedure.....	83
Starting the Engine - Remote Control Models.....	83
Starting the Engine - Tiller Handle Models.....	86
Gear Shifting	89
Stopping the Engine	90
Emergency Starting.....	90

Maintenance

Outboard Care.....	93
EPA Emission Regulations.....	93
Inspection and Maintenance Schedule.....	94
Top Cowl Removal and Installation.....	96
Exterior Care.....	97
Worn/Dull Impeller.....	97
Impeller Clearance Adjustment.....	98
Impeller Removal and Installation.....	99
Shift Link Rod Adjustment.....	103
Battery Inspection	104
Fuel System.....	105
Steering Link Rod Fasteners.....	106
Corrosion Control Anode.....	108
Spark Plug Inspection and Replacement.....	109
Fuse Replacement - Electric Start Models.....	110
Timing Belt Inspection.....	111
Lubrication Points.....	112
Checking Power Trim Fluid.....	115
Changing Engine Oil	116
Submerged Outboard.....	118

Storage

Storage Preparation.....	119
Protecting External Outboard Components.....	119
Protecting Internal Engine Components.....	120
Jet Drive.....	120
Positioning Outboard for Storage.....	120
Battery Storage.....	120

Troubleshooting

Starter Motor will not Crank the Engine (Electric Start Models)	122
.....	122
Engine Will Not Start.....	122
Engine Runs Erratically.....	123
Engine Overspeed (Excessive RPM).....	123
Performance Loss.....	123
Battery Will Not Hold Charge.....	124

Owner Service Assistance

Local Repair Service.....	125
Service Away from Home.....	125
Parts and Accessories Inquiries.....	125
Service Assistance.....	125
Ordering Literature.....	128

Installation

Installation Information.....	130
Top Cowl Removal and Installation.....	131
Lifting Outboard.....	132
Determining the Mounting Height of the Outboard	133
Fastening the Outboard.....	135
Steering Bracket, Steering Cable Installation.....	138
Steering Link Rod Fasteners.....	139
Electrical Harness, Battery Connection, Fuel Tanks.....	141
Control Cable Installation.....	145
Water Testing.....	150

Maintenance Log

Maintenance Log.....	152
----------------------	-----

WARRANTY INFORMATION

Warranty Registration United States and Canada

To be eligible for warranty coverage, the product must be registered with Mercury Marine.

At the time of sale, the selling dealer should complete the warranty registration and immediately submit it to Mercury Marine via MercNET, e-mail, or mail. Upon receipt of this warranty registration, Mercury Marine will record the registration.

A copy of the warranty registration should be provided to you by your selling dealer.

NOTE: Registration lists must be maintained by Mercury Marine and any dealer of Mercury Marine products sold in the United States, should a safety recall notification under the Federal Safety Act be required.

You may change your registered address at any time, including at time of warranty claim, by calling Mercury Marine or sending a letter or fax with your name, old address, new address, and engine serial number to Mercury Marine's warranty registration department. Your dealer can also process this change of information.

Mercury Marine

Attn: Warranty Registration Department

W6250 W. Pioneer Road

P.O. Box 1939

Fond du Lac, WI 54936-1939

920-929-5054

Fax +1 920 907 6663

OUTSIDE UNITED STATES AND CANADA

For products purchased outside the United States and Canada, contact the distributor in your country, or the Marine Power Service Center closest to you.

Transfer of Warranty United States and Canada

The limited warranty is transferable to a subsequent purchaser, but only for the remainder of the unused portion of the limited warranty. This will not apply to products used for commercial applications.

WARRANTY INFORMATION

To transfer the warranty to the subsequent owner, send or fax a copy of the bill of sale or purchase agreement, new owner's name, address, and engine serial number to Mercury Marine's warranty registration department. In the United States and Canada, mail to:

Mercury Marine
Attn: Warranty Registration Department
W6250 W. Pioneer Road
P.O. Box 1939
Fond du Lac, WI 54936-1939
920-929-5054
Fax +1 920 907 6663

Upon processing the transfer of warranty, Mercury Marine will record the new owner's information.

There is no charge for this service.

OUTSIDE THE UNITED STATES AND CANADA

For products purchased outside the United States and Canada, contact the distributor in your country, or the Marine Power Service Center closest to you.

Transfer of Mercury Product Protection (Extended Service Coverage) Plan United States and Canada

The remaining coverage period of the Product Protection Plan is transferable to the subsequent purchaser of the engine within thirty (30) days from the date of sale. Contracts not transferred within thirty (30) days of the subsequent purchase will no longer be valid and the product will no longer be eligible for coverage under the terms of the contract.

To transfer the plan to the subsequent owner, contact Mercury Product Protection or an authorized dealer to receive a Request for Transfer form. Submit to Mercury Product Protection a receipt/bill of sale, a completed Request of Transfer form, and a check payable to Mercury Marine in the amount of \$50.00 (per engine) to cover the transfer fee.

Plan coverage is not transferable from one product to another product or for noneligible applications.

The certified preowned engine plans are not transferable.

WARRANTY INFORMATION

For help or assistance, contact Mercury Product Protection Department at 1-888-427-5373 from 7:30 a.m. to 4:30 p.m. CST, Monday–Friday or e-mail mpp_support@mercmarine.com.

FourStroke Outboard Limited Warranty United States and Canada

Outside the United States and Canada - Check with your local distributor.

WHAT IS COVERED: Mercury Marine warrants its new products to be free of defects in material and workmanship during the period described below.

DURATION OF COVERAGE: This Limited Warranty provides coverage for three (3) years from the date the product is first sold to a recreational use retail purchaser, or the date on which the product is first put into service, whichever occurs first.

Commercial users of these products receive warranty coverage of one (1) year from the date of first retail sale, or one (1) year from the date on which the product was first put into service, whichever occurs first. Commercial use is defined as any work or employment related use of the product, or any use of the product which generates income, for any part of the warranty period, even if the product is only occasionally used for such purposes.

The repair or replacement of parts, or the performance of service under this warranty, does not extend the life of this warranty beyond its original expiration date. Unexpired warranty coverage can be transferred from one recreational use customer to a subsequent recreational use customer upon proper reregistration of the product. Unexpired warranty coverage cannot be transferred either to or from a commercial use customer.

Warranty coverage may be terminated for used repossessed product; or product purchased at auction, from a salvage yard, or from an insurance company.

WARRANTY INFORMATION

CONDITIONS THAT MUST BE MET IN ORDER TO OBTAIN WARRANTY COVERAGE: Warranty coverage is available only to retail customers that purchase from a Dealer authorized by Mercury Marine to distribute the product in the country in which the sale occurred, and then only after the Mercury Marine specified predelivery inspection process is completed and documented. Warranty coverage becomes available upon proper registration of the product by the authorized dealer. Inaccurate warranty registration information regarding recreational use, or subsequent change of use from recreational to commercial (unless properly reregistered) may void the warranty at the sole discretion of Mercury Marine. Routine maintenance outlined in the Operation and Maintenance Manual must be timely performed in order to maintain warranty coverage. Mercury Marine reserves the right to make warranty coverage contingent upon proof of proper maintenance.

WHAT MERCURY WILL DO: Mercury's sole and exclusive obligation under this warranty is limited to, at our option, repairing a defective part, replacing such part or parts with new or Mercury Marine certified remanufactured parts, or refunding the purchase price of the Mercury product. Mercury reserves the right to improve or modify products from time to time without assuming an obligation to modify products previously manufactured.

WARRANTY INFORMATION

HOW TO OBTAIN WARRANTY COVERAGE: The customer must provide Mercury with a reasonable opportunity to repair, and reasonable access to the product for warranty service. Warranty claims shall be made by delivering the product for inspection to a Mercury dealer authorized to service the product. If purchaser cannot deliver the product to such a dealer, written notice must be given to Mercury. We will then arrange for the inspection and any covered repair. Purchaser, in that case, shall pay for all related transportation charges and/or travel time. If the service provided is not covered by this warranty, purchaser shall pay for all related labor and material, and any other expenses associated with that service. Purchaser shall not, unless requested by Mercury, ship the product or parts of the product directly to Mercury. Proof of registered ownership must be presented to the dealer at the time warranty service is requested in order to obtain coverage.

WHAT IS NOT COVERED: This limited warranty does not cover routine maintenance items, tune-ups, adjustments, normal wear and tear, damage caused by abuse, abnormal use, use of a propeller or gear ratio that does not allow the engine to run in its recommended wide-open throttle RPM range (see the Operation and Maintenance Manual), operation of the product in a manner inconsistent with the recommended operation/duty cycle section of the Operation and Maintenance Manual, neglect, accident, submersion, improper installation (proper installation specifications and techniques are set forth in the installation instructions for the product), improper service, use of an accessory or part not manufactured or sold by us, jet pump impellers and liners, operation with fuels, oils, or lubricants which are not suitable for use with the product (see the Operation and Maintenance Manual), alteration or removal of parts, water entering the engine through the fuel intake, air intake or exhaust system, or damage to the product from insufficient cooling water caused by blockage of the cooling system by a foreign body, running the engine out of water, mounting the engine too high on the transom, or running the boat with the engine trimmed out too far. Use of the product for racing or other competitive activity, or operating with a racing type lower unit, at any point, even by a prior owner of the product, voids the warranty.

WARRANTY INFORMATION

Expenses related to haul-out, launch, towing, storage, telephone, rental, inconvenience, slip fees, insurance coverage, loan payments, loss of time, loss of income, or any other type of incidental or consequential damages are not covered by this warranty. Also, expenses associated with the removal and/or replacement of boat partitions or material caused by boat design for access to the product are not covered by this warranty.

No individual or entity, including Mercury Marine authorized dealers, has been given authority by Mercury Marine to make any affirmation, representation, or warranty regarding the product, other than those contained in this limited warranty, and if made, shall not be enforceable against Mercury Marine.

For additional information regarding events and circumstances covered by this warranty, and those that are not, see the Warranty Coverage section of the Operation and Maintenance Manual, incorporated by reference into this warranty.

DISCLAIMERS AND LIMITATIONS:

THE IMPLIED WARRANTIES OF MERCHANTABILITY AND FITNESS FOR A PARTICULAR PURPOSE ARE EXPRESSLY DISCLAIMED. TO THE EXTENT THAT THEY CANNOT BE DISCLAIMED, THE IMPLIED WARRANTIES ARE LIMITED IN DURATION TO THE LIFE OF THE EXPRESS WARRANTY. INCIDENTAL AND CONSEQUENTIAL DAMAGES ARE EXCLUDED FROM COVERAGE UNDER THIS WARRANTY. SOME STATES/COUNTRIES DO NOT ALLOW FOR THE DISCLAIMERS, LIMITATIONS AND EXCLUSIONS IDENTIFIED ABOVE, AS A RESULT, THEY MAY NOT APPLY TO YOU. THIS WARRANTY GIVES YOU SPECIFIC LEGAL RIGHTS, AND YOU MAY ALSO HAVE OTHER LEGAL RIGHTS WHICH VARY FROM STATE TO STATE AND COUNTRY TO COUNTRY.

3 Year Limited Warranty Against Corrosion

WHAT IS COVERED: Mercury Marine warrants that each new Mercury, Mariner, Mercury Racing, Sport-Jet, M² Jet Drive, Tracker by Mercury Marine Outboard, Mercury MerCruiser Inboard or Sterndrive Engine (Product) will not be rendered inoperative as a direct result of corrosion for the period of time described below.

WARRANTY INFORMATION

DURATION OF COVERAGE: This limited corrosion warranty provides coverage for three (3) years from either the date the product is first sold, or the date on which the product is first put into service, whichever occurs first. The repair or replacement of parts, or the performance of service under this warranty, does not extend the life of this warranty beyond its original expiration date. Unexpired warranty coverage can be transferred to subsequent (noncommercial use) purchaser upon proper reregistration of the product.

CONDITIONS THAT MUST BE MET IN ORDER TO OBTAIN WARRANTY COVERAGE: Warranty coverage is available only to retail customers that purchase from a Dealer authorized by Mercury Marine to distribute the product in the country in which the sale occurred, and then only after the Mercury Marine specified predelivery inspection process is completed and documented. Warranty coverage becomes available upon proper registration of the product by the authorized dealer. Corrosion prevention devices specified in the Operation and Maintenance Manual must be in use on the boat, and routine maintenance outlined in the Operation and Maintenance Manual must be timely performed (including, without limitation, the replacement of sacrificial anodes, use of specified lubricants, and touch-up of nicks and scratches) in order to maintain warranty coverage. Mercury Marine reserves the right to make warranty coverage contingent upon proof of proper maintenance.

WHAT MERCURY WILL DO: Mercury's sole and exclusive obligation under this warranty is limited to, at our option, repairing a corroded part, replacing such part or parts with new or Mercury Marine certified remanufactured parts, or refunding the purchase price of the Mercury product. Mercury reserves the right to improve or modify products from time to time without assuming an obligation to modify products previously manufactured.

WARRANTY INFORMATION

HOW TO OBTAIN WARRANTY COVERAGE: The customer must provide Mercury with a reasonable opportunity to repair, and reasonable access to the product for warranty service. Warranty claims shall be made by delivering the product for inspection to a Mercury dealer authorized to service the product. If purchaser cannot deliver the product to such a dealer, written notice must be given to Mercury. We will then arrange for the inspection and any covered repair. Purchaser, in that case, shall pay for all related transportation charges and/or travel time. If the service provided is not covered by this warranty, purchaser shall pay for all related labor and material, and any other expenses associated with that service. Purchaser shall not, unless requested by Mercury, ship the product or parts of the product directly to Mercury. Proof of registered ownership must be presented to the dealer at the time warranty service is requested in order to obtain coverage.

WHAT IS NOT COVERED: This limited warranty does not cover electrical system corrosion; corrosion resulting from damage, corrosion which causes purely cosmetic damage, abuse, or improper service; corrosion to accessories, instruments, steering systems; corrosion to factory installed jet drive unit; damage due to marine growth; product sold with less than a one year limited Product warranty; replacement parts (parts purchased by customer); products used in a commercial application. Commercial use is defined as any work or employment related use of the product, or any use of the product which generates income, for any part of the warranty period, even if the product is only occasionally used for such purposes.

WARRANTY INFORMATION

Corrosion damage caused by stray electrical currents (onshore power connections, nearby boats, submerged metal) is not covered by this corrosion warranty and should be protected against by the use of a corrosion protection system, such as the Mercury Precision Parts or Quicksilver MerCathode system and/or Galvanic Isolator. Corrosion damage caused by improper application of copper base antifouling paints is also not covered by this limited warranty. If antifouling protection is required, Tri-Butyl-Tin-Adipate (TBTA) base antifouling paints are recommended on Outboard and MerCruiser boating applications. In areas where TBTA base paints are prohibited by law, copper base paints can be used on the hull and transom. Do not apply paint to the outboard or MerCruiser product. In addition, care must be taken to avoid an electrical interconnection between the warranted product and the paint. For MerCruiser product, an unpainted gap of at least 38 mm (1.5 in.) should be left around the transom assembly. Refer to the Operation and Maintenance Manual for additional details.

For additional information regarding events and circumstances covered by this warranty, and those that are not, see the Warranty Coverage section of the Operation and Maintenance Manual, incorporated by reference into this warranty.

DISCLAIMERS AND LIMITATIONS:

THE IMPLIED WARRANTIES OF MERCHANTABILITY AND FITNESS FOR A PARTICULAR PURPOSE ARE EXPRESSLY DISCLAIMED. TO THE EXTENT THAT THEY CANNOT BE DISCLAIMED, THE IMPLIED WARRANTIES ARE LIMITED IN DURATION TO THE LIFE OF THE EXPRESS WARRANTY. INCIDENTAL AND CONSEQUENTIAL DAMAGES ARE EXCLUDED FROM COVERAGE UNDER THIS WARRANTY. SOME STATES/COUNTRIES DO NOT ALLOW FOR THE DISCLAIMERS, LIMITATIONS AND EXCLUSIONS IDENTIFIED ABOVE, AS A RESULT, THEY MAY NOT APPLY TO YOU. THIS WARRANTY GIVES YOU SPECIFIC LEGAL RIGHTS, AND YOU MAY ALSO HAVE OTHER LEGAL RIGHTS WHICH VARY FROM STATE TO STATE AND COUNTRY TO COUNTRY.

WARRANTY INFORMATION

Warranty Coverage and Exclusions

The purpose of this section is to help eliminate some of the more common misunderstandings regarding warranty coverage. The following information explains some of the types of services that are not covered by warranty. The provisions set forth following have been incorporated by reference into the Three Year Limited Warranty Against Corrosion Failure, the International Limited Outboard Warranty, and the United States and Canada Limited Outboard Warranty.

Keep in mind that warranty covers repairs that are needed within the warranty period because of defects in material and workmanship. Installation errors, accidents, normal wear, and a variety of other causes that affect the product are not covered.

Warranty is limited to defects in material or workmanship, but only when the consumer sale is made in the country to which distribution is authorized by us.

Should you have any questions concerning warranty coverage, contact your authorized dealer. They will be pleased to answer any questions that you may have.

GENERAL EXCLUSIONS FROM WARRANTY

1. Minor adjustments and tune-ups, including checking, cleaning, or adjusting spark plugs, ignition components, carburetor settings, filters, belts, controls, and checking lubrication made in connection with normal services.
2. Factory installed jet drive units - Specific parts excluded from the warranty are: the jet drive impeller and jet drive liner damaged by impact or wear, and water damaged driveshaft bearings as a result of improper maintenance.
3. Damage caused by neglect, lack of maintenance, accident, abnormal operation, or improper installation or service.
4. Haul-out, launch, towing charges, removal and/or replacement of boat partitions or material because of boat design for necessary access to the product, all related transportation charges and/or travel time, etc. Reasonable access must be provided to the product for warranty service. Customer must deliver product to an authorized dealer.

WARRANTY INFORMATION

5. Additional service work requested by customer other than that necessary to satisfy the warranty obligation.
6. Labor performed by other than an authorized dealer may be covered only under the following circumstances: when performed on emergency basis (providing there are no authorized dealers in the area who can perform the work required or have no facilities to haul-out, etc., and prior factory approval has been given to have the work performed at this facility).
7. All incidental and/or consequential damages (storage charges, telephone or rental charges of any type, inconvenience or loss of time or income) are the owner's responsibility.
8. Use of other than Mercury Precision or Quicksilver parts when making warranty repairs.
9. Oils, lubricants, or fluids changed as a matter of normal maintenance is customer's responsibility unless loss or contamination of same is caused by product failure that would be eligible for warranty consideration.
10. Participating in or preparing for racing or other competitive activity or operating with a racing type lower unit.
11. Engine noise does not necessarily indicate a serious engine problem. If diagnosis indicates a serious internal engine condition which could result in a failure, condition responsible for noise should be corrected under the warranty.
12. Lower unit and/or propeller damage caused by striking a submerged object is considered a marine hazard.
13. Water entering engine through the fuel intake, air intake, or exhaust system or submersion.
14. Failure of any parts caused by lack of cooling water, which results from starting motor out of water, foreign material blocking inlet holes, motor being mounted too high, or trimmed too far out.
15. Use of fuels and lubricants which are not suitable for use with or on the product. Refer to the **Maintenance** section.

WARRANTY INFORMATION

16. Our limited warranty does not apply to any damage to our products caused by the installation or use of parts and accessories which are not manufactured or sold by us. Failures which are not related to the use of those parts or accessories are covered under warranty if they otherwise meet the terms of the limited warranty for that product.

U.S. EPA Emissions Limited Warranty

Consistent with the obligations created by 40 CFR Part 1045, Subpart B, Mercury Marine provides a five year or 175 hours of engine use, whichever occurs first, to the retail customer, that the engine is designed, built, and equipped so as to conform at the time of sale with applicable regulations under section 213 of the Clean Air Act, and that the engine is free from defects in materials and workmanship which cause the engine to fail to conform with applicable regulations. This emission-related warranty covers all the components listed in the **Emission Control System Components**.

Emission Control System Components

The EPA and California emission-related warranty covers all the following list of components:

COMPONENTS OF THE EMISSIONS CONTROL SYSTEM:

1. Fuel metering system
 - a. Carburetor and internal parts (and/or pressure regulator or fuel injection system)
 - b. Cold start enrichment system
 - c. Intake valves
2. Air induction system
 - a. Intake manifold
 - b. Turbocharger or supercharger systems (where applicable)
3. Ignition system
 - a. Spark plugs
 - b. Magneto or electronic ignition system
 - c. Spark advance/retard system

WARRANTY INFORMATION

- d. Ignition coil and/or control module
- e. Ignition wires
- 4. Lubrication system (4-Stroke engines excluded)
 - a. Oil pump and internal parts
 - b. Oil injectors
 - c. Oil meter
- 5. Exhaust system
 - a. Exhaust manifold
 - b. Exhaust valves
- 6. Miscellaneous items used in above systems
 - a. Hoses, clamps, fittings, tubing, sealing gaskets or devices, and mounting hardware
 - b. Pulleys, belts, and idlers
 - c. Vacuum, temperature, check and time sensitive valves and switches
 - d. Electronic controls

The emission-related warranty does not cover components whose failure would not increase an engine's emissions on any regulated pollutant.

California Emissions Limited Warranty

The California Air Resources Board has promulgated air emission regulations for outboard engines. The regulations apply to all outboard engines sold to retail consumers in California, and which were manufactured for the 2001 model year and later. Mercury Marine, in compliance with those regulations, provides this limited warranty for the emission control systems (see the components listed in the **Emission Control System Components**), and further warrants that the outboard engine was designed, built, and equipped to conform with all applicable regulations adopted by the California Air Resources Board pursuant to its authority in Chapters 1 and 2, Part 5, Division 26 of the Health and Safety Code. For information regarding the limited warranty for the nonemission-related components of the outboard, please see the limited warranty statement for your outboard.

WARRANTY INFORMATION

WHAT IS COVERED: Mercury Marine warrants the components of the emissions control systems (see the components listed in the **Emission Control System Components**) of its new, 2001 model year and later outboards, sold by a California dealer to retail customers residing in California, to be free from defects in material or workmanship, that cause the failure of a warranted part to be identical in all material respects to that part as described in the application of Mercury Marine for certification from the California Air Resources Board, for the period of time, and under the conditions, identified below. The cost to diagnose a warranty failure is covered under the warranty (if the warranty claim is approved). Damage to other engine components caused by the failure of a warranted part will also be repaired under warranty.

DURATION OF COVERAGE: This limited warranty provides coverage for the components of the emissions control systems of new, 2001 model year and later outboards, sold to retail customers in California for four (4) years from either the date the product is first sold, or first put into service, whichever occurs first, or the accumulation of 250 hours of engine operation (as determined by the engine's hour meter, if any). Emission-related normal maintenance items such as spark plugs and filters, that are on the warranted parts list, are warranted up to their first required replacement interval only. Refer to **Emission Control System Components and Maintenance Schedule**. The repair or replacement of parts, or the performance of service under this warranty, does not extend the life of this warranty beyond its original expiration date. Unexpired warranty coverage can be transferred to a subsequent purchaser. (See instructions on transfer of warranty.)

WARRANTY INFORMATION

HOW TO OBTAIN WARRANTY COVERAGE: The customer must provide Mercury with a reasonable opportunity to repair and reasonable access to the product for warranty service. Warranty claims shall be made by delivering the product for inspection to a Mercury dealer authorized to service the product. If purchaser cannot deliver the product to such a dealer, please notify Mercury Marine and Mercury will then arrange for the inspection and any covered repair. Purchaser, in that case, shall pay for all related transportation charges and/or travel time. If the service provided is not covered by this warranty, purchaser shall pay for all related labor and material, and any other expenses associated with that service. Purchaser shall not, unless requested by Mercury, ship the product or parts of the product directly to Mercury.

WHAT MERCURY WILL DO: Mercury Marine's sole and exclusive obligation under this warranty is limited to, at our expense and at our option, repairing or replacing defective parts with new or Mercury Marine certified remanufactured parts, or refunding the purchase price of the Mercury product. Mercury reserves the right to improve or modify products from time to time without assuming an obligation to modify products previously manufactured.

WHAT IS NOT COVERED: This limited warranty does not cover routine maintenance items, tune-ups, adjustments, normal wear and tear, damage caused by abuse, abnormal use, use of a propeller or gear ratio that does not allow the engine to run in its recommended wide-open throttle RPM range (see **General Information - Specifications**), operation of the product in a manner inconsistent with the recommended operation procedures, neglect, accident, submersion, improper installation (proper installation specifications and techniques are set forth in the installation instructions for the product), improper service, jet pump impellers and liners, operation with fuels, oils, or lubricants which are not suitable for use with the product (see **Fuel and Oil**), alteration or removal of parts.

WARRANTY INFORMATION

Expenses related to haul-out, launch, towing, storage, telephone, rental, inconvenience, slip fees, insurance coverage, loan payments, loss of time, loss of income, or any other type of incidental or consequential damages are not covered by this warranty. Also, expenses associated with the removal and/or replacement of boat partitions or material caused by boat design for access to the product are not covered by this warranty.

Nonwarranty maintenance, replacement, or repair of emission control devices and systems may be performed by any marine engine repair establishment or individual. The use of non-Mercury parts for nonwarranty maintenance or repairs will not be grounds for disallowing other warranty work. The use of add-on (as defined at section 1900 (b)(1) and (b)(10) of Title 13 of the California Code of Regulations) or modified parts not exempted by the California Air Resources Board may be grounds for disallowing a warranty claim, at the discretion of Mercury Marine. Failures of warranted parts caused by the use of a nonexempted add-on or modified part will not be covered.

DISCLAIMERS AND LIMITATIONS

THE IMPLIED WARRANTIES OF MERCHANTABILITY AND FITNESS FOR A PARTICULAR PURPOSE ARE EXPRESSLY DISCLAIMED. TO THE EXTENT THAT THEY CANNOT BE DISCLAIMED, THE IMPLIED WARRANTIES ARE LIMITED IN DURATION TO THE LIFE OF THE EXPRESS WARRANTY. INCIDENTAL AND CONSEQUENTIAL DAMAGES ARE EXCLUDED FROM COVERAGE UNDER THIS WARRANTY. SOME STATES/COUNTRIES DO NOT ALLOW FOR THE DISCLAIMERS, LIMITATIONS AND EXCLUSIONS IDENTIFIED ABOVE, AS A RESULT, THEY MAY NOT APPLY TO YOU. THIS WARRANTY GIVES YOU SPECIFIC LEGAL RIGHTS, AND YOU MAY ALSO HAVE OTHER LEGAL RIGHTS WHICH VARY FROM STATE TO STATE AND COUNTRY TO COUNTRY.

If you have any questions regarding your warranty rights and responsibilities, you should contact Mercury Marine at 1-920-929-5040.

WARRANTY INFORMATION

California Air Resources Board Explanation of Your California Emission Control Warranty Statement

YOUR WARRANTY RIGHTS AND OBLIGATIONS: The California Air Resources Board is pleased to explain the emission control system warranty on your 2012–2013 model year outboard engine. In California, new outboard engines must be designed, built, and equipped to meet the State's stringent anti-smog standards. Mercury Marine must warrant the emission control system on your outboard engine for the periods of time listed below, provided there has been no abuse, neglect, or improper maintenance of your outboard engine.

Your emission control system may include parts such as the carburetor or fuel injection system, the ignition system, and catalytic converter. Also included may be hoses, belts, connectors, and other emission-related assemblies.

Where a warrantable condition exists, Mercury Marine will repair your outboard engine at no cost to you, including diagnosis, parts, and labor.

MANUFACTURER'S WARRANTY COVERAGE: Select emission control parts from model year 2001 and later outboard engines are warranted for four (4) years, or for 250 hours of use, whichever first occurs. However, warranty coverage based on the hourly period is only permitted for outboard engines and personal watercraft equipped with hour meters as defined in s 2441(a)(13) or their equivalent. If any emission-related part on your engine is defective under warranty, the part will be repaired or replaced by Mercury Marine.

OWNER'S WARRANTY RESPONSIBILITIES: As the outboard engine owner, you are responsible for the performance of the required maintenance listed in the **Maintenance** section. Mercury Marine recommends that you retain all receipts covering maintenance on your outboard engine, but Mercury Marine cannot deny warranty solely for the lack of receipts or your failure to ensure the performance of all scheduled maintenance.

WARRANTY INFORMATION

As the outboard engine owner, you should, however, be aware that Mercury Marine may deny you warranty coverage if your outboard engine or a part has failed due to abuse, neglect, improper maintenance, or unapproved modifications.

You are responsible for presenting your outboard to a Mercury dealer authorized to service the product as soon as a problem exists. The warranty repairs will be completed in a reasonable amount of time, not to exceed 30 days.

If you have any questions regarding your warranty rights and responsibilities, you should contact Mercury Marine at 1-920-929-5040.

Emission Certification Star Label



Outboards are labeled on the cowl with one of the following star labels.

The symbol for a cleaner marine engine means:



Cleaner air and water - for a healthier lifestyle and environment.

Better fuel economy - burns up to 30–40 percent less gas and oil than conventional carbureted two-stroke engines, saving money and resources.

Longer emission warranty - protects consumer for worry-free operation.

 <p>22531</p>	<p>One Star - Low Emission</p> <p>The One Star label identifies engines that meet the Air Resources Board's 2001 exhaust emissions standards. Engines meeting these standards have 75% lower emissions than conventional carbureted two-stroke engines. These engines are equivalent to the U.S. EPA's 2006 standards for marine engines.</p>
 <p>42537</p>	<p>Two Stars - Very Low Emission</p> <p>The Two Star label identifies engines that meet the Air Resources Board's Personal Watercraft and Outboard marine engine 2004 exhaust emissions standards. Engines meeting these standards have 20% lower emissions than One Star - Low Emission engines.</p>

WARRANTY INFORMATION

 <p>42538</p>	<p>Three Stars - Ultra Low Emission</p> <p>The Three Star label identifies engines that meet the Air Resources Board's Personal Watercraft and Outboard marine engine 2008 exhaust emissions standards or the Sterndrive and Inboard marine engine 2003-2008 exhaust emission standards. Engines meeting these standards have 65% lower emissions than One Star - Low Emission engines.</p>
 <p>42539</p>	<p>Four Stars - Super Ultra Low Emission</p> <p>The Four Star label identifies engines that meet the Air Resources Board's Sterndrive and Inboard marine engine 2009 exhaust emission standards. Personal Watercraft and Outboard marine engines may also comply with these standards. Engines meeting these standards have 90% lower emissions than One Star - Low Emission engines.</p>

Warranty Policies Outside The United States and Canada

MERCURY/MARINER OUTBOARD LIMITED WARRANTY-AUSTRALIA AND NEW ZEALAND POLICY

This limited warranty is given by Marine Power International Pty Ltd ACN 003 100 007 of 41-71 Bessemer Drive, Dandenong South, Victoria 3175 Australia (telephone (61) (3) 9791 5822) e-mail: merc_info@mercmarine.com.

What is Covered

Mercury Marine warrants its new products to be free of defects in material and workmanship during the period described below. The benefits to the consumer given by the warranty are in addition to other rights and remedies of the consumer under a law in relation to the goods or services to which the warranty relates.

WARRANTY INFORMATION

Guarantees Under Australian Consumer Law

Our goods come with guarantees that cannot be excluded under the Australian Consumer Law. You are entitled to a replacement or refund for a major failure and compensation for any other reasonably foreseeable loss or damage. You are also entitled to have the goods repaired or replaced if the goods fail to be of acceptable quality and the failure does not amount to a major failure.

Warranty Period for Recreational Use

This Limited Warranty provides coverage for three (3) years from the date the product is first sold to a recreational use retail purchaser, or the date on which the product is first put into service, whichever occurs first. Unexpired warranty coverage can be transferred to a subsequent recreational use customer upon proper registration of the product.

Warranty Period for Commercial Use

Commercial users of these products receive warranty coverage under this Limited Warranty of one (1) year from the date of first retail sale, or one (1) year from the date on which the product was first put into service, whichever occurs first. Commercial use is defined as any work or employment related use of the product, or any use of the product which generates income, for any part of the warranty period, even if the product is only occasionally used for such purposes. Unexpired warranty coverage cannot be transferred either to or from a commercial use customer.

WARRANTY INFORMATION

Conditions That Must Be Met to Obtain Warranty Coverage

Warranty coverage under this Limited Warranty is available only to retail customers that purchase from a Dealer authorized by Mercury Marine to distribute the product in the country in which the sale occurred, and then only after the Mercury Marine specified predelivery inspection process is completed and documented. Warranty coverage becomes available upon proper registration of the product by the authorized dealer. Inaccurate warranty registration information regarding recreational use, or subsequent change of use from recreational to commercial (unless properly registered) may void the warranty at the sole discretion of Mercury Marine. Routine maintenance outlined in the Operation and Maintenance Manual must be timely performed in order to maintain warranty coverage. Mercury Marine reserves the right to make warranty coverage contingent upon proof of proper maintenance.

What Mercury Will Do

Mercury Marine's sole and exclusive obligation under this Limited Warranty is limited to, at our option, repairing a defective part, replacing such part or parts with new or Mercury Marine certified remanufactured parts, or refunding the purchase price of the Mercury Marine product. Mercury Marine reserves the right to improve or modify products from time to time without assuming an obligation to modify products previously manufactured.

WARRANTY INFORMATION

How to Obtain Warranty Coverage Under This Limited Warranty

The customer must provide Mercury Marine with a reasonable opportunity to repair and reasonable access to the product for warranty service. Warranty claims shall be made by delivering the product for inspection to a Mercury Marine dealer authorized to service the product. A list of dealers and their contact details is available at www.mercurymarine.com.au. If the purchaser cannot deliver the product to such a dealer, written notice must be given to Mercury Marine at the address shown above. Mercury Marine will then arrange for the inspection and any covered repair. This Limited Warranty will not cover the purchaser for all related transportation charges and travel time. If the service provided is not covered by this limited warranty, the purchaser shall pay for all related labor and material and any other expenses associated with that service, provided that a consumer will not be obligated to pay where the service has been carried out to remedy a failure of an acceptable quality guarantee which is binding on Mercury Marine under the Australian Consumer Law. The purchaser shall not, unless requested by Mercury Marine, ship the product or parts of the product directly to Mercury Marine. Proof of registered ownership must be presented to the dealer at the time warranty service is requested in order to obtain coverage under this Limited Warranty.

WARRANTY INFORMATION

What is Not Covered

This limited warranty does not cover routine maintenance items, tune-ups, adjustments, normal wear and tear, damage caused by abuse, abnormal use, use of a propeller or gear ratio that does not allow the engine to run in its recommended wide-open throttle RPM range (see the Operation and Maintenance Manual), operation of the product in a manner inconsistent with the recommended operation/duty cycle section of the Operation and Maintenance Manual, neglect, accident, submersion, improper installation (proper installation specifications and techniques are set forth in the installation instructions for the product), improper service, use of an accessory or part not manufactured or sold by us, jet pump impellers and liners, operation with fuels, oils or lubricants which are not suitable for use with the product (see the Operation and Maintenance Manual), alteration or removal of parts, water entering the engine through the fuel intake, air intake or exhaust system, or damage to the product from insufficient cooling water caused by blockage of the cooling system by a foreign body, running the engine out of water, mounting the engine too high on the transom, or running the boat with the engine trimmed out too far. Use of the product for racing or other competitive activity, or operating with a racing type lower unit, at any point, even by a prior owner of the product, voids the warranty.

Expenses related to haul-out, launch, towing, storage, telephone, rental, inconvenience, slip fees, insurance coverage, loan payments, loss of time, loss of income, or any other type of incidental or consequential damages are not covered by this Limited Warranty. Also, expenses associated with the removal and/or replacement of boat partitions or material caused by boat design for access to the product are not covered by this warranty.

WARRANTY INFORMATION

No individual or entity, including Mercury Marine authorized dealers, has been given authority by Mercury Marine to make any affirmation, representation or warranty regarding the product, other than those contained in this limited warranty, and if made, shall not be enforceable against Mercury Marine. For additional information regarding events and circumstances covered by this warranty, and those that are not, see the Warranty Coverage section of the Operation and Maintenance Manual, incorporated by reference into this warranty.

Expense of Claiming This Limited Warranty

This Limited Warranty does not cover any expenses you may incur claiming the warranty.

DISCLAIMERS AND LIMITATIONS:
EXCEPT FOR APPLICABLE GUARANTEES AND OTHER RIGHTS AND REMEDIES THAT A CONSUMER MAY HAVE UNDER THE AUSTRALIAN CONSUMER LAW OR OTHER LAW IN RELATION TO WHICH THE PRODUCTS RELATE, THE IMPLIED WARRANTIES OF MERCHANTABILITY AND FITNESS FOR A PARTICULAR PURPOSE ARE EXPRESSLY DISCLAIMED. TO THE EXTENT THAT THEY CANNOT BE DISCLAIMED, THE IMPLIED WARRANTIES ARE LIMITED IN DURATION TO THE LIFE OF THE EXPRESS WARRANTY. INCIDENTAL AND CONSEQUENTIAL DAMAGES ARE EXCLUDED FROM COVERAGE UNDER THIS LIMITED WARRANTY.

TRANSFER OF WARRANTY—AUSTRALIA AND NEW ZEALAND POLICY

The limited warranty is transferable to a subsequent purchaser, but only for the remainder of the unused portion of the limited warranty. This will not apply to products used for commercial applications.

To transfer the warranty to the subsequent owner, send or fax a copy of the Bill of Sale or Purchase Agreement, new owner's name, address, and hull identification number (HIN) to Mercury Marine's Warranty Registration Department. In Australia and New Zealand, mail to:

WARRANTY INFORMATION

Mercury Marine
Attn: Warranty Registration Department
Brunswick Asia Pacific Group
Private Bag 1420
Dandenong South, Victoria 3164
Australia

Upon processing the transfer of warranty, Mercury Marine will send registration verification to the new owner of the product by mail. There is no charge for this service.

You may change your address at any time, including at the time of the warranty claim, by calling Mercury Marine or sending a letter or fax with your name, old address, new address, and hull identification number (HIN) to Mercury Marine's Warranty Registration Department.

FOURSTROKE OUTBOARD LIMITED WARRANTY EUROPE AND CONFEDERATION OF INDEPENDENT STATES

Outside Europe and Confederation of Independent States - check with local distributor.

WHAT IS COVERED: Mercury Marine warrants its new products to be free of defects in material and workmanship during the period described below.

WARRANTY INFORMATION

DURATION OF COVERAGE: This Limited Warranty provides coverage for two (2) years from the date the product is first sold to a recreational use retail purchaser, or the date on which the product is first put into service, whichever occurs first.

Commercial users of these products receive warranty coverage of one (1) year from the date of first retail sale, or one (1) year from the date in which the product was first put into service, whichever occurs first. Commercial use is defined as any work or employment related use of the product, or any use of the product which generates income, for any part of the warranty period, even if the product is only occasionally used for such purposes.

The repair or replacement of parts, or the performance of service under this warranty, does not extend the life of this warranty beyond its original expiration date. Unexpired warranty coverage can be transferred from one recreational use customer to a subsequent recreational use customer upon proper reregistration of the product. Unexpired warranty coverage cannot be transferred either to or from a commercial use customer.

Warranty coverage may be terminated for used or repossessed product; or product purchased at auction, from a salvage yard, or from an insurance company.

CONDITIONS THAT MUST BE MET IN ORDER TO OBTAIN WARRANTY COVERAGE: Warranty coverage is available only to retail customers that purchase from a Dealer authorized by Mercury Marine to distribute the product in the country in which the sale occurred, and then only after the Mercury Marine specified predelivery inspection process is completed and documented. Warranty coverage becomes available upon proper registration of the product by the authorized dealer. Routine maintenance outlined in the Operation and Maintenance Manual must be timely performed in order to maintain warranty coverage. Mercury Marine reserves the right to make future warranty coverage contingent on proof of proper maintenance.

WARRANTY INFORMATION

WHAT MERCURY WILL DO: Mercury's sole and exclusive obligation under this warranty is limited to, at our option, repairing a defective part, replacing such part or parts with new or Mercury Marine certified remanufactured parts, or refunding the purchase price of the Mercury product. Mercury reserves the right to improve or modify products from time to time without assuming an obligation to modify products previously manufactured.

HOW TO OBTAIN WARRANTY COVERAGE: The customer must provide Mercury with a reasonable opportunity to repair, and reasonable access to the product for warranty service. Warranty claims shall be made by delivering the product for inspection to a Mercury dealer authorized to service the product. If purchaser cannot deliver the product to such a dealer, written notice must be given to Mercury. We will then arrange for the inspection and any covered repair. Purchaser in that case shall pay for all related transportation charges and/or travel time. If the service provided is not covered by this warranty, purchaser shall pay for all related labor and material, and any other expenses associated with that service. Purchaser shall not, unless requested by Mercury, ship the product or parts of the product directly to Mercury. Proof of registered ownership must be presented to the dealer at the time warranty service is requested in order to obtain coverage.

WARRANTY INFORMATION

WHAT IS NOT COVERED: This limited warranty does not cover routine maintenance items, tune-ups, adjustments, normal wear and tear, damage caused by abuse, abnormal use, use of a propeller or gear ratio that does not allow the engine to run in its recommended wide-open throttle RPM range (see the Operation and Maintenance Manual), operation of the product in a manner inconsistent with the recommended operation/duty cycle section of the Operation and Maintenance Manual, neglect, accident, submersion, improper installation (proper installation specifications and techniques are set forth in the installation instructions for the product), improper service, use of an accessory or part not manufactured or sold by us, jet pump impellers and liners, operation with fuels, oils or lubricants which are not suitable for use with the product (see the Operation and Maintenance Manual), alteration or removal of parts, or water entering the engine through the fuel intake, air intake or exhaust system, or damage to the product from insufficient cooling water caused by blockage of the cooling system by a foreign body, running the engine out of water, mounting the engine too high on the transom, or running the boat with the engine trimmed out too far. Use of the product for racing or other competitive activity, or operating with a racing type lower unit, at any point, even by a prior owner of the product, voids the warranty.

Expenses related to haul out, launch, towing, storage, telephone, rental, inconvenience, slip fees, insurance coverage, loan payments, loss of time, loss of income, or any other type of incidental or consequential damages are not covered by this warranty. Also, expenses associated with the removal and/or replacement of boat partitions or material caused by boat design for access to the product are not covered by this warranty.

No individual or entity, including Mercury Marine authorized dealers, has been given authority by Mercury Marine to make any affirmation, representation or warranty regarding the product, other than those contained in this limited warranty, and if made, shall not be enforceable against Mercury Marine.

WARRANTY INFORMATION

For additional information regarding events and circumstances covered by this warranty, and those that are not, see the Warranty Coverage section of the Operation and Maintenance Manual, incorporated by reference into this warranty.

DISCLAIMERS AND LIMITATIONS:

THE IMPLIED WARRANTIES OF MERCHANTABILITY AND FITNESS FOR A PARTICULAR PURPOSE ARE EXPRESSLY DISCLAIMED. TO THE EXTENT THAT THEY CANNOT BE DISCLAIMED, THE IMPLIED WARRANTIES ARE LIMITED IN DURATION TO THE LIFE OF THE EXPRESS WARRANTY. INCIDENTAL AND CONSEQUENTIAL DAMAGES ARE EXCLUDED FROM COVERAGE UNDER THIS WARRANTY. SOME STATES/COUNTRIES DO NOT ALLOW FOR THE DISCLAIMERS, LIMITATIONS AND EXCLUSIONS IDENTIFIED ABOVE, AS A RESULT, THEY MAY NOT APPLY TO YOU. THIS WARRANTY GIVES YOU SPECIFIC LEGAL RIGHTS, AND YOU MAY ALSO HAVE OTHER LEGAL RIGHTS WHICH VARY FROM STATE TO STATE AND COUNTRY TO COUNTRY.

FOURSTROKE OUTBOARD LIMITED WARRANTY MIDDLE-EAST AND AFRICA (EXCLUDING VERADO)

WHAT IS COVERED: Mercury Marine warrants its new Outboard and Jet Products to be free of defects in material and workmanship during the period described below.

WARRANTY INFORMATION

DURATION OF COVERAGE: This Limited Warranty provides coverage for one (2) year from the date the product is first sold to a recreational use retail purchaser, or the date on which the product is first put into service, whichever occurs first.

Commercial users of these products receive warranty coverage of one (1) years from the date of first retail sale, or one (1) year from the date on which the product was first put into service, whichever occurs first. Commercial use is defined as any work or employment related use of the product, or any use of the product which generates income, for any part of the warranty period, even if the product is only occasionally used for such purposes. The repair or replacement of parts, or the performance of service under this warranty, does not extend the life of this warranty beyond its original expiration date. Unexpired warranty coverage can be transferred from one recreational use customer to a subsequent recreational use customer upon proper reregistration of the product. Unexpired warranty coverage cannot be transferred either to or from a commercial use customer.

CONDITIONS THAT MUST BE MET IN ORDER TO OBTAIN WARRANTY COVERAGE: Warranty coverage is available only to retail customers that purchase from a Dealer authorized by Mercury Marine to distribute the product in the country in which the sale occurred, and then only after the Mercury Marine specified predelivery inspection process is completed and documented. Warranty coverage becomes available upon proper registration of the product by the authorized dealer. Routine maintenance outlined in the Operation and Maintenance Manual must be timely performed in order to maintain warranty coverage. Mercury Marine reserves the right to make warranty coverage contingent on proof of proper maintenance.

WHAT MERCURY WILL DO: Mercury's sole and exclusive obligation under this warranty is limited to, at our option, repairing a defective part, replacing such part or parts with new or Mercury Marine certified remanufactured parts, or refunding the purchase price of the Mercury product. Mercury reserves the right to improve or modify products from time to time without assuming an obligation to modify products previously manufactured.

WARRANTY INFORMATION

HOW TO OBTAIN WARRANTY COVERAGE: The customer must provide Mercury with a reasonable opportunity to repair, and reasonable access to the product for warranty service. Warranty claims shall be made by delivering the product for inspection to a Mercury dealer authorized to service the product. If purchaser cannot deliver the product to such a dealer, written notice must be given to Mercury. We will then arrange for the inspection and any covered repair. Purchaser in that case shall pay for all related transportation charges and/or travel time. If the service provided is not covered by this warranty, purchaser shall pay for all related labor and material, and any other expenses associated with that service. Purchaser shall not, unless requested by Mercury, ship the product or parts of the product directly to Mercury. Proof of registered ownership must be presented to the dealer at the time warranty service is requested in order to obtain coverage.

WHAT IS NOT COVERED: This limited warranty does not cover routine maintenance items, tune-ups, adjustments, normal wear and tear, damage caused by abuse, abnormal use, use of a propeller or gear ratio that does not allow the engine to run in its recommended wide-open throttle RPM range (see the Operation and Maintenance Manual), operation of the product in a manner inconsistent with the recommended operation/duty cycle section of the Operation and Maintenance Manual, neglect, accident, submersion, improper installation (proper installation specifications and techniques are set forth in the installation instructions for the product), improper service, use of an accessory or part not manufactured or sold by us, jet pump impellers and liners, operation with fuels, oils or lubricants which are not suitable for use with the product (see the Operation and Maintenance Manual), alteration or removal of parts, or water entering the engine through the fuel intake, air intake or exhaust system, or damage to the product from insufficient cooling water caused by blockage of the cooling system by foreign body, running the engine out of water, mounting the engine too high on the transom, or running the boat with the engine trimmed out too far.

WARRANTY INFORMATION

Use of the product for racing or other competitive activity, or operating with a racing type lower unit, at any point, even by a prior owner of the product, voids the warranty.

Expenses related to haul out, launch, towing, storage, telephone, rental, inconvenience, slip fees, insurance coverage, loan payments, loss of time, loss of income, or any other type of incidental or consequential damages are not covered by this warranty. Also, expenses associated with the removal and/or replacement of boat partitions or material caused by boat design for access to the product are not covered by this warranty.

No individual or entity, including Mercury Marine authorized dealers, has been given authority by Mercury Marine to make any affirmation, representation or warranty regarding the product, other than those contained in this limited warranty, and if made, shall not be enforceable against Mercury Marine.

For additional information regarding events and circumstances covered by this warranty, and those that are not, see the Warranty Coverage section of the Operation and Maintenance Manual, incorporated by reference into this warranty.

DISCLAIMERS AND LIMITATIONS:

THE IMPLIED WARRANTIES OF MERCHANTABILITY AND FITNESS FOR A PARTICULAR PURPOSE ARE EXPRESSLY DISCLAIMED. TO THE EXTENT THAT THEY CANNOT BE DISCLAIMED, THE IMPLIED WARRANTIES ARE LIMITED IN DURATION TO THE LIFE OF THE EXPRESS WARRANTY. INCIDENTAL AND CONSEQUENTIAL DAMAGES ARE EXCLUDED FROM COVERAGE UNDER THIS WARRANTY. SOME STATES/COUNTRIES DO NOT ALLOW FOR THE DISCLAIMERS, LIMITATIONS AND EXCLUSIONS IDENTIFIED ABOVE, AS A RESULT, THEY MAY NOT APPLY TO YOU. THIS WARRANTY GIVES YOU SPECIFIC LEGAL RIGHTS, AND YOU MAY ALSO HAVE OTHER LEGAL RIGHTS WHICH VARY FROM STATE TO STATE AND COUNTRY TO COUNTRY.

GENERAL INFORMATION

Boater's Responsibilities

The operator (driver) is responsible for the correct and safe operation of the boat and the safety of its occupants and general public. It is strongly recommended that each operator read and understand this entire manual before operating the outboard.

Be sure that at least one additional person onboard is instructed in the basics of starting and operating the outboard and boat handling in case the driver is unable to operate the boat.

Before Operating Your Outboard

Read this manual carefully. Learn how to operate your outboard properly. If you have any questions, contact your dealer.

Safety and operating information that is practiced, along with using good common sense, can help prevent personal injury and product damage.

This manual as well as safety labels posted on the outboard use the following safety alerts to draw your attention to special safety instructions that should be followed.

DANGER

Indicates a hazardous situation which, if not avoided, will result in death or serious injury.

WARNING

Indicates a hazardous situation which, if not avoided, could result in death or serious injury.

CAUTION

Indicates a hazardous situation which, if not avoided, could result in minor or moderate injury.

NOTICE

Indicates a situation which, if not avoided, could result in engine or major component failure.

GENERAL INFORMATION

Boat Horsepower Capacity

WARNING

Exceeding the boat's maximum horsepower rating can cause serious injury or death. Overpowering the boat can affect boat control and flotation characteristics or break the transom. Do not install an engine that exceeds the boat's maximum power rating.

Do not overpower or overload your boat. Most boats will carry a required capacity plate indicating the maximum acceptable power and load as determined by the manufacturer following certain federal guidelines. If in doubt, contact your dealer or the boat manufacturer.

U.S. COAST GUARD CAPACITY	
MAXIMUM HORSEPOWER	XXX
MAXIMUM PERSON CAPACITY (POUNDS)	XXX
MAXIMUM WEIGHT CAPACITY	XXX

26777

High-Speed and High-Performance Boat Operation

If your outboard is to be used on a high-speed or high-performance boat with which you are unfamiliar, we recommend that you never operate it at its high speed capability without first requesting an initial orientation and familiarization demonstration ride with your dealer or an operator experienced with your boat/outboard combination. For additional information, obtain a copy of our **Hi-Performance Boat Operation** booklet from your dealer, distributor, or Mercury Marine.

GENERAL INFORMATION

Outboard Remote Control Models

The remote control connected to your outboard must be equipped with a start in neutral only protection device. This prevents the engine from starting when the shift is actuated in any position other than neutral.

WARNING

Starting the engine with the drive in gear can cause serious injury or death. Never operate a boat that does not have a neutral-safety-protection device.

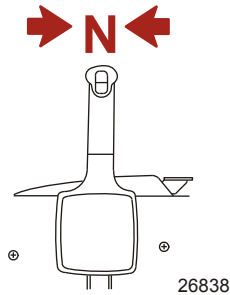

Remote Steering Notice

The steering link rod that connects the steering cable to the engine must be fastened utilizing self-locking nuts. These self-locking nuts must never be replaced with common nuts (non-locking) as they will work loose and vibrate off, freeing the link rod to disengage.

GENERAL INFORMATION

⚠ WARNING

Improper fasteners or improper installation procedures can result in loosening or disengagement of the steering link rod. This can cause a sudden, unexpected loss of boat control, resulting in serious injury or death due to occupants being thrown within or out of the boat. Always use required components and follow instructions and torque procedures.

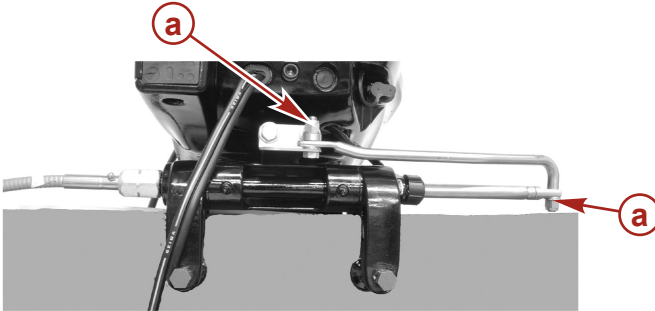

9938

a - Self-locking nuts

Lanyard Stop Switch

The purpose of a lanyard stop switch is to turn off the engine when the operator moves far enough away from the operator's position (as in accidental ejection from the operator's position) to activate the switch. Tiller handle outboards and some remote control units are equipped with a lanyard stop switch. A lanyard stop switch can be installed as an accessory - generally on the dashboard or side adjacent to the operator's position.

GENERAL INFORMATION

The lanyard is a cord usually 122–152 cm (4–5 feet) in length when stretched out, with an element on one end made to be inserted into the switch and a snap on the other end for attaching to the operator. The lanyard is coiled to make its at-rest condition as short as possible to minimize the likelihood of lanyard entanglement with nearby objects. Its stretched-out length is made to minimize the likelihood of accidental activation should the operator choose to move around in an area close to the normal operator's position. If it is desired to have a shorter lanyard, wrap the lanyard around the operator's wrist or leg, or tie a knot in the lanyard.

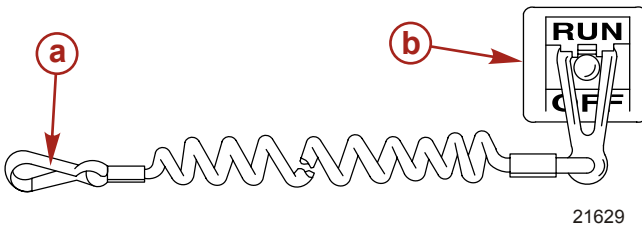

- a** - Lanyard cord
- b** - Lanyard stop switch

Read the following Safety Information before proceeding.

GENERAL INFORMATION

Important Safety Information: The purpose of a lanyard stop switch is to stop the engine when the operator moves far enough away from the operator's position to activate the switch. This would occur if the operator accidentally falls overboard or moves within the boat a sufficient distance from the operator's position. Falling overboard and accidental ejections are more likely to occur in certain types of boats such as low sided inflatables, bass boats, high performance boats, and light, sensitive handling fishing boats operated by a hand tiller. Falling overboard and accidental ejections are also likely to occur as a result of poor operating practices such as sitting on the back of the seat or gunwale at planing speeds, standing at planing speeds, sitting on elevated fishing boat decks, operating at planing speeds in shallow or obstacle infested waters, releasing your grip on a steering wheel or tiller handle that is pulling in one direction, drinking alcohol or consuming drugs, or daring high speed boat maneuvers.

While activation of the lanyard stop switch will stop the engine immediately, a boat will continue to coast for some distance depending upon the velocity and degree of any turn at shut down. However, the boat will not complete a full circle. While the boat is coasting, it can cause injury to anyone in the boat's path as seriously as the boat would when under power.

We strongly recommend that other occupants be instructed on proper starting and operating procedures should they be required to operate the engine in an emergency (if the operator is accidentally ejected).

WARNING

If the operator falls out of the boat, stop the engine immediately to reduce the possibility of serious injury or death from being struck by the boat. Always properly connect the operator to the stop switch using a lanyard.

GENERAL INFORMATION

WARNING

Avoid serious injury or death from deceleration forces resulting from accidental or unintended stop switch activation. The boat operator should never leave the operator's station without first disconnecting the stop switch lanyard from the operator.

Accidental or unintended activation of the switch during normal operation is also a possibility. This could cause any, or all, of the following potentially hazardous situations:

- Occupants could be thrown forward due to unexpected loss of forward motion - a particular concern for passengers in the front of the boat who could be ejected over the bow and possibly struck by the gearcase or propeller.
- Loss of power and directional control in heavy seas, strong current, or high winds.
- Loss of control when docking.

KEEP THE LANYARD STOP SWITCH AND LANYARD CORD IN GOOD OPERATING CONDITION

Before each use, check to ensure the lanyard stop switch works properly. Start the engine and stop it by pulling the lanyard cord. If the engine does not stop, have the switch repaired before operating the boat.

Before each use, visually inspect the lanyard cord to ensure it is in good working condition and that there are no breaks, cuts, or wear to the cord. Check that the clips on the ends of the cord are in good condition. Replace any damaged or worn lanyard cords.

GENERAL INFORMATION

Protecting People In The Water

WHILE YOU ARE CRUISING

It is very difficult for a person standing or floating in the water to take quick action to avoid a boat heading in his/her direction, even at slow speed.



Always slow down and exercise extreme caution when boating in an area where there might be people in the water.

Avoid shallow water or where any loose material such as sand, shells, seaweed, grass, tree branches, etc., can be pulled in and expelled from the pump as a high speed projectile.

WHILE BOAT IS STATIONARY

WARNING

Avoid injury resulting from contacting the rotating impeller or having hair, clothing, or loose objects drawn into the water intake and wrapping around the impeller shaft. Stay away from the water intake and never insert an object into the water intake or water outlet nozzle when the engine is running.

Stop the engine immediately whenever a person is in the water near the boat. The jet drive is always drawing water through the water intake when the engine is running. Stay away from the water intake located under the jet drive and never insert an object into the water intake or outlet nozzle when the engine is running.

GENERAL INFORMATION

Wave and Wake Jumping

Operating recreational boats over waves and wake is a natural part of boating. However, when this activity is done with sufficient speed to force the boat hull partially or completely out of the water, certain hazards arise, particularly when the boat enters the water.

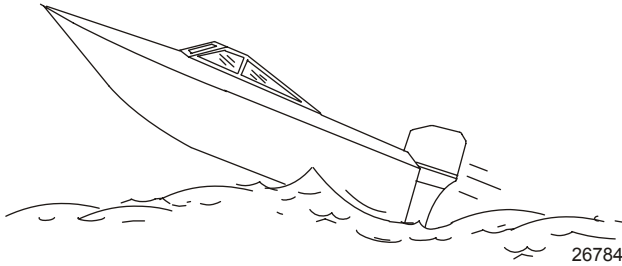

The primary concern is the boat changing direction while in the midst of the jump. In such case, the landing may cause the boat to veer violently in a new direction. Such a sharp change in direction can cause occupants to be thrown out of their seats, or out of the boat.

WARNING

Wave or wake jumping can cause serious injury or death from occupants being thrown within or out of the boat. Avoid wave or wake jumping whenever possible.

There is another less common hazardous result from allowing your boat to launch off a wave or wake. If the bow of your boat pitches down far enough while airborne, upon water contact it may penetrate under the water surface and submarine for an instant. This will bring the boat to a nearly instantaneous stop and can send the occupants flying forward. The boat may also steer sharply to one side.

Safety Instructions for Hand-Tilled Outboards

No person or cargo should occupy the area directly in front of the outboard while the boat is in motion. If an underwater obstacle is struck, the outboard will tilt up and could seriously injure anyone occupying this area.

GENERAL INFORMATION

MODELS WITH CLAMP SCREWS:

Some outboards come with transom bracket clamp screws. The use of clamp bracket screws alone, is insufficient to properly and safely secure the outboard to the transom. Proper installation of the outboard includes bolting the engine to the boat through the transom. Refer to **Installation - Installing Outboard** for more complete installation information.

WARNING

Failure to correctly fasten the outboard could result in the outboard propelling off the boat transom resulting in property damage, serious injury, or death. Before operation, the outboard must be correctly installed with the required mounting hardware.

If an obstacle is struck at planing speed and the outboard is not securely fastened to the transom, it is possible the outboard could lift off the transom and land in the boat.

Exhaust Emissions

BE ALERT TO CARBON MONOXIDE POISONING

Carbon monoxide (CO) is a deadly gas that is present in the exhaust fumes of all internal combustion engines, including the engines that propel boats, and the generators that power boat accessories. By itself, CO is odorless, colorless, and tasteless, but if you can smell or taste engine exhaust, you are inhaling CO.

Early symptoms of carbon monoxide poisoning, which are similar to the symptoms of seasickness and intoxication, include headache, dizziness, drowsiness, and nausea.

GENERAL INFORMATION

WARNING

Inhaling engine exhaust gases can result in carbon monoxide poisoning, which can lead to unconsciousness, brain damage, or death. Avoid exposure to carbon monoxide.

Stay clear from exhaust areas when engine is running. Keep the boat well-ventilated while at rest or underway.

STAY CLEAR OF EXHAUST AREAS

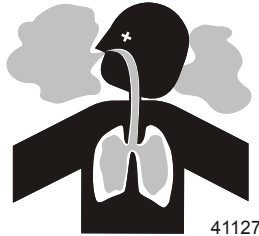

Engine exhaust gases contain harmful carbon monoxide. Avoid areas of concentrated engine exhaust gases. When engines are running, keep swimmers away from the boat, and do not sit, lie, or stand on swim platforms or boarding ladders. While underway, do not allow passengers to be positioned immediately behind the boat (platform dragging, teak/body surfing). This dangerous practice not only places a person in an area of high engine exhaust concentration, but also subjects them to the possibility of injury from the boat propeller.

GOOD VENTILATION

Ventilate the passenger area, open side curtains or forward hatches to remove fumes.

Example of desired air flow through the boat:

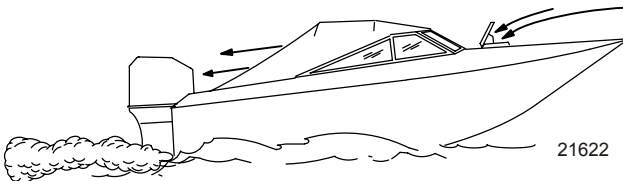

GENERAL INFORMATION

POOR VENTILATION

Under certain running and/or wind conditions, permanently enclosed or canvas enclosed cabins or cockpits with insufficient ventilation may draw in carbon monoxide. Install one or more carbon monoxide detectors in your boat.

Although the occurrence is rare, on a very calm day, swimmers and passengers in an open area of a stationary boat that contains, or is near, a running engine may be exposed to a hazardous level of carbon monoxide.

1. Examples of poor ventilation while the boat is stationary:

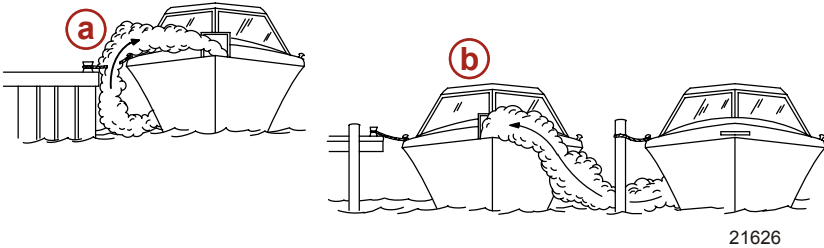

- a** - Operating the engine when the boat is moored in a confined space
- b** - Mooring close to another boat that has its engine operating

2. Examples of poor ventilation while the boat is moving:

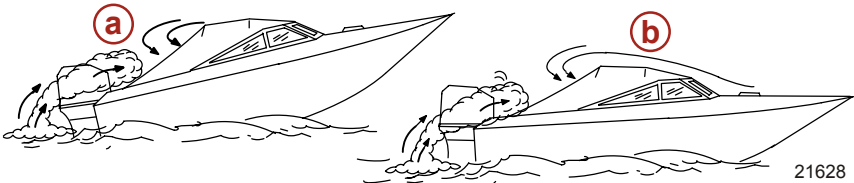

- a** - Operating the boat with the trim angle of the bow too high
- b** - Operating the boat with no forward hatches open (station wagon effect)

GENERAL INFORMATION

Selecting Accessories for Your Outboard

Genuine Mercury Precision or Quicksilver Accessories have been specifically designed and tested for your outboard. These accessories are available from Mercury Marine dealers.

IMPORTANT: Check with your dealer before installing accessories. The misuse of approved accessories or the use of nonapproved accessories can damage the product.

Some accessories not manufactured or sold by Mercury Marine are not designed to be safely used with your outboard or outboard operating system. Acquire and read the installation, operation and maintenance manuals for all your selected accessories.

Safe Boating Recommendations

To safely enjoy the waterways, familiarize yourself with local and all other governmental boating regulations and restrictions and consider the following suggestions.

Know and obey all nautical rules and laws of the waterways.

- We recommend that all powerboat operators complete a boating safety course. In the U.S., the U.S. Coast Guard Auxiliary, the Power Squadron, the Red Cross, and your state or provincial boating law enforcement agency provide courses. For more information in the U.S., call the Boat U.S. Foundation at 1-800-336-BOAT (2628).

Perform safety checks and required maintenance.

- Follow a regular schedule and ensure that all repairs are properly made.

Check safety equipment onboard.

- Here are some suggestions of the types of safety equipment to carry when boating:
 - Approved fire extinguishers
 - Signal devices: flashlight, rockets or flares, flag, and whistle or horn
 - Tools necessary for minor repairs
 - Anchor and extra anchor line

GENERAL INFORMATION

- Manual bilge pump and extra drain plugs
- Drinking water
- Radio
- Paddle or oar
- Spare propeller, thrust hubs, and an appropriate wrench
- First aid kit and instructions
- Waterproof storage containers
- Spare operating equipment, batteries, bulbs, and fuses
- Compass and map or chart of the area
- Personal flotation device (one per person onboard)

Watch for signs of weather change and avoid foul weather and rough-sea boating.

Tell someone where you are going and when you expect to return.

Passenger boarding.

- Stop the engine whenever passengers are boarding, unloading, or are near the back (stern) of the boat. Shifting the drive unit into neutral is not sufficient.

Use personal flotation devices.

- Federal law requires that there be a U.S. Coast Guard-approved life jacket (personal flotation device), correctly sized and readily accessible for every person onboard, plus a throwable cushion or ring. We strongly advise that everyone wear a life jacket at all times while in the boat.

Prepare other boat operators.

- Instruct at least one person onboard in the basics of starting and operating the engine and boat handling in case the driver becomes disabled or falls overboard.

Do not overload your boat.

GENERAL INFORMATION

- Most boats are rated and certified for maximum load (weight) capacities (refer to your boat's capacity plate). Know your boat's operating and loading limitations. Know if your boat will float if it is full of water. When in doubt, contact your authorized Mercury Marine dealer or the boat manufacturer.

Ensure that everyone in the boat is properly seated.

- Do not allow anyone to sit or ride on any part of the boat that was not intended for such use. This includes the backs of seats, gunwales, transom, bow, decks, raised fishing seats, and any rotating fishing seat. Passengers should not sit or ride anywhere that sudden unexpected acceleration, sudden stopping, unexpected loss of boat control, or sudden boat movement could cause a person to be thrown overboard or into the boat. Ensure that all passengers have a proper seat and are in it before any boat movement.

Never operate a boat while under the influence of alcohol or drugs. It is the law.

- Alcohol or drugs can impair your judgment and greatly reduce your ability to react quickly.

Know your boating area and avoid hazardous locations.

Be alert.

- The operator of the boat is responsible by law to maintain a proper lookout by sight and hearing. The operator must have an unobstructed view particularly to the front. No passengers, load, or fishing seats should block the operator's view when the boat is above idle or planing transition speed. Watch out for others, the water, and your wake.

Never drive your boat directly behind a water skier.

- Your boat traveling at 40 km/h (25 mph) will overtake a fallen skier who is 61 m (200 ft) in front of you in five seconds.

Watch fallen skiers.

GENERAL INFORMATION

- When using your boat for waterskiing or similar activities, always keep a fallen or down skier on the operator's side of the boat while returning to attend to the skier. The operator should always have the down skier in sight and never back up to the skier or anyone in the water.

Report accidents.

- Boat operators are required by law to file a boating accident report with their state boating law enforcement agency when their boat is involved in certain boating accidents. A boating accident must be reported if 1) there is loss of life or probable loss of life, 2) there is personal injury requiring medical treatment beyond first aid, 3) there is damage to boats or other property where the damage value exceeds \$500.00, or 4) there is complete loss of the boat. Seek further assistance from local law enforcement.

Recording Serial Number

It is important to record this number for future reference. The serial number is located on the outboard as shown.

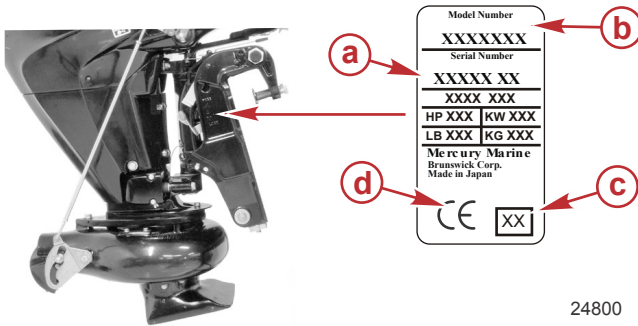

24800

- a** - Serial number
- b** - Model designation
- c** - Year manufactured
- d** - Certified Europe Insignia (as applicable)

GENERAL INFORMATION

Specifications

Models	25
Power	18.4 kw (25 hp)
Full throttle RPM range	5000–5500 RPM
Idle speed in forward gear	850 ± 25 RPM
Number of cylinders	3
Piston displacement	526 cc (32.09 cid)
Cylinder bore	61 mm (2.40 in.)
Stroke	60 mm (2.36 in.)
Valve clearance (cold)	
Intake valve	0.13–0.17 mm (0.005–0.007 in.)
Exhaust valve	0.18–0.22 mm (0.007–0.008 in.)
Recommended spark plug	NGK DCPR6E
Spark plug gap	0.8–0.9 mm (0.031–0.035 in.)
Recommended gasoline	Refer to Fuel and Oil
Recommended oil	Refer to Fuel and Oil
Recommended lubricant for the jet pump driveshaft bearing	Refer to Maintenance
Engine oil capacity	1.8 liter (1.9 US qt)
Battery rating	465 marine cranking amps (MCA) or 350 cold cranking amps (CCA)
Emission control system	Electronic engine control (EC)

GENERAL INFORMATION

Component Identification

TILLER HANDLE/GAS ASSIST MODEL

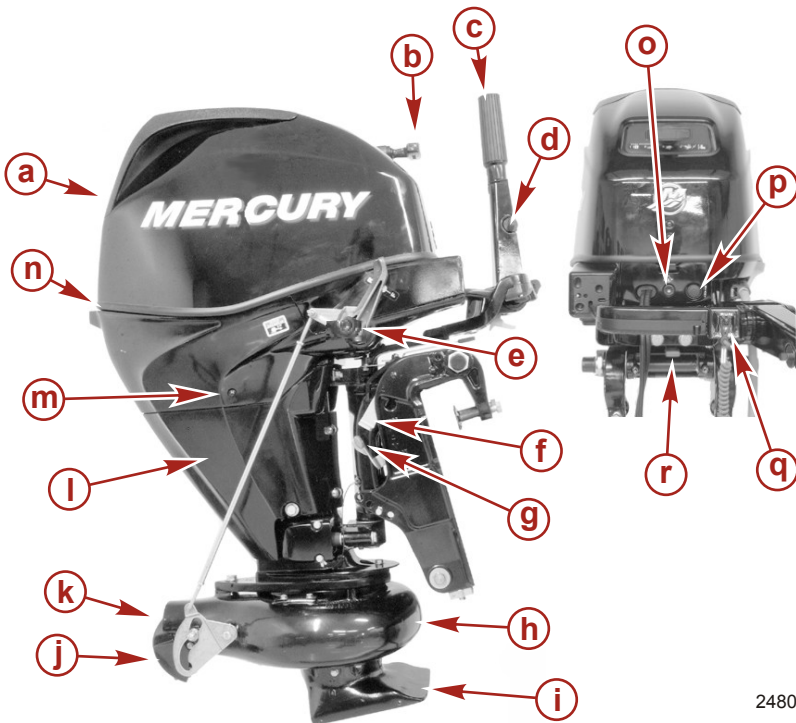

24805

- a** - Top cowl
- b** - Manual start handle
- c** - Engine stop switch
- d** - Throttle friction adjustment knob
- e** - Gear shift
- f** - Tilt support lever
- g** - Gas tilt assist lever
- h** - Jet drive housing
- i** - Water intake housing
- j** - Reverse gate
- k** - Water outlet housing
- l** - Chaps

GENERAL INFORMATION

- m** - Water pump indicator hole
- n** - Cowl latch
- o** - Warning light
- p** - Electric start button (electric start models)
- q** - Lanyard stop switch
- r** - Steering friction adjustment lever

GENERAL INFORMATION

POWER TRIM/REMOTE CONTROL MODEL



24827

- a** - Transom brackets
- b** - Tilt support lever
- c** - Top cowl
- d** - Cowl latch
- e** - Bottom cowl
- f** - Auxiliary tilt switch
- g** - Chaps
- h** - Water outlet housing
- i** - Reverse gate
- j** - Water intake housing
- k** - Jet drive housing

TRANSPORTING

Trailer Boat/Outboard

The boat should be trailered with the outboard tilted down in a vertical operating position.

IMPORTANT: Do not rely on the power trim/tilt system or tilt support lever to maintain proper ground clearance for trailering. The outboard tilt support lever is not intended to support the outboard for trailering.

If additional ground clearance is required, the outboard should be tilted up using an accessory outboard support device. Refer to your local dealer for recommendations. Additional clearance may be required for railroad crossings, driveways and trailer bouncing.

FUEL AND OIL

Fuel Recommendations

IMPORTANT: Use of improper gasoline can damage your engine. Engine damage resulting from the use of improper gasoline is considered misuse of the engine, and damage caused thereby will not be covered under the limited warranty.

FUEL RATINGS

Mercury Marine engines will operate satisfactorily when using a major brand of unleaded gasoline meeting the following specifications:

USA and Canada - having a posted pump octane rating of 87 (R+M)/2 minimum. Premium gasoline (92 [R+M]/2 octane) is also acceptable. Do not use leaded gasoline.

Outside USA and Canada - having a posted pump octane rating of 90 RON minimum. Premium gasoline (98 RON) is also acceptable. If unleaded gasoline is not available, use a major brand of leaded gasoline.

USING REFORMULATED (OXYGENATED) GASOLINES (USA ONLY)

This type of gasoline is required in certain areas of the USA. The two types of oxygenates used in these fuels are alcohol (ethanol) or ether (MTBE or ETBE). If ethanol is the oxygenate that is used in the gasoline in your area, refer to **Gasolines Containing Alcohol**.

These reformulated gasolines are acceptable for use in your Mercury Marine engine.

GASOLINES CONTAINING ALCOHOL

If the gasoline in your area contains either methanol (methyl alcohol) or ethanol (ethyl alcohol), you should be aware of certain adverse effects that can occur. These adverse effects are more severe with methanol. Increasing the percentage of alcohol in the fuel can also worsen these adverse effects.

Some of these adverse effects are caused because the alcohol in the gasoline can absorb moisture from the air, resulting in a separation of the water/alcohol from the gasoline in the fuel tank.

FUEL AND OIL

The fuel system components on your Mercury Marine engine will withstand up to 10% alcohol content in the gasoline. We do not know what percentage your boat's fuel system will withstand. Contact your boat manufacturer for specific recommendations on the boat's fuel system components (fuel tanks, fuel lines, and fittings). Be aware that gasolines containing alcohol may cause increased:

- Corrosion of metal parts
- Deterioration of rubber or plastic parts
- Fuel permeation through rubber fuel lines
- Starting and operating difficulties

WARNING

Fuel leakage is a fire or explosion hazard, which can cause serious injury or death. Periodically inspect all fuel system components for leaks, softening, hardening, swelling, or corrosion, particularly after storage. Any sign of leakage or deterioration requires replacement before further engine operation.

Because of possible adverse effects of alcohol in gasoline, it is recommended that only alcohol-free gasoline be used where possible. If only fuel containing alcohol is available, or if the presence of alcohol is unknown, increased inspection frequency for leaks and abnormalities is required.

IMPORTANT: When operating a Mercury Marine engine on gasoline containing alcohol, storage of gasoline in the fuel tank for long periods should be avoided. Long periods of storage, common to boats, create unique problems. In cars, alcohol-blend fuels normally are consumed before they can absorb enough moisture to cause trouble, but boats often sit idle long enough for phase separation to take place. In addition, internal corrosion may take place during storage if alcohol has washed protective oil films from internal components.

Low Permeation Fuel Hose Requirement

Required for outboards manufactured for sale, sold, or offered for sale in the United States.

FUEL AND OIL

- The Environmental Protection Agency (EPA) requires that any outboard manufactured after January 1, 2009, must use low permeation fuel hose for the primary fuel hose connecting the fuel tank to the outboard.
- Low permeation hose is USCG Type B1-15 or Type A1-15, defined as not exceeding 15/gm²/24 h with CE 10 fuel at 23 °C as specified in SAE J 1527 - marine fuel hose.

EPA Pressurized Portable Fuel Tank Requirements

The Environmental Protection Agency (EPA) requires portable fuel systems that are produced after January 1, 2011, for use with outboard engines to remain fully sealed (pressurized) up to 34.4 kPa (5.0 psi). These tanks may contain the following:

- An air inlet that opens to allow air to enter as the fuel is drawn out of the tank.
- An air outlet that opens (vents) to the atmosphere if pressure exceeds 34.4 kPa (5.0 psi).

Fuel Demand Valve (FDV) Requirement

Whenever a pressurized fuel tank is used, a fuel demand valve is required to be installed in the fuel hose between the fuel tank and primer bulb. The fuel demand valve prevents pressurized fuel from entering the engine and causing a fuel system overflow or possible fuel spillage.

The fuel demand valve has a manual release. The manual release can be used (pushed in) to open (bypass) the valve in case of a fuel blockage in the valve.

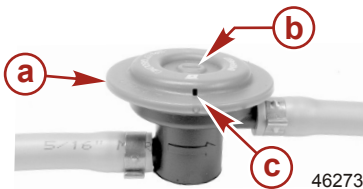

- a** - Fuel demand valve - installed in the fuel hose between the fuel tank and primer bulb
- b** - Manual release
- c** - Vent/water drain holes

FUEL AND OIL

Mercury Marine's Pressurized Portable Fuel Tank

Mercury Marine has created a new portable pressurized fuel tank that meets the preceding EPA requirements. These fuel tanks are available as an accessory or are provided with certain portable outboard models.

SPECIAL FEATURES OF THE PORTABLE FUEL TANK

- The fuel tank has a two-way valve which allows air to enter the tank as the fuel is drawn to the engine, and also opens to vent to the atmosphere if internal pressure in the tank exceeds 34.4 kPa (5.0 psi). A hissing noise may be heard as the tank vents to the atmosphere. This is normal.
- The fuel tank includes a fuel demand valve that prevents pressurized fuel from entering the engine and causing a fuel system overflow or possible fuel spillage.
- When installing the fuel tank cap, turn the cap to the right until you hear a click. This signals that the fuel cap is fully seated. A built-in device prevents overtightening.
- The fuel tank has a manual vent screw which should be closed for transportation and open for operation and cap removal.

Since sealed fuel tanks are not vented, they will expand and contract as the fuel expands and contracts during heating and cooling cycles of the outside air. This is normal.

REMOVING THE FUEL CAP

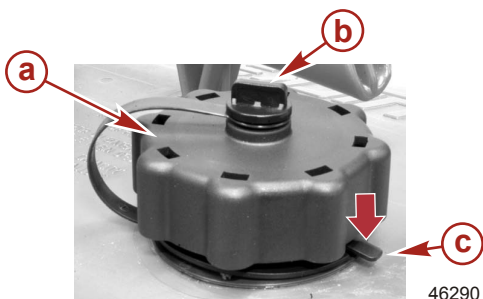

- a** - Fuel cap
- b** - Manual vent screw
- c** - Tab lock

46290

IMPORTANT: Contents may be under pressure. Rotate the fuel cap 1/4 turn to relieve pressure before opening.

1. Open the manual vent screw on top of the fuel cap.

FUEL AND OIL

2. Turn the fuel cap until it contacts the tab lock.
3. Press down on the tab lock. Rotate the fuel cap 1/4 turn to relieve the pressure.
4. Press down on the tab lock again and remove the cap.

DIRECTIONS FOR USING THE PRESSURIZED PORTABLE FUEL TANK

1. When installing the fuel tank cap, turn the cap to the right until you hear a click. This signals that the fuel cap is fully seated. A built-in device prevents overtightening.
2. Open the manual vent screw on top of the cap for operation and cap removal. Close the manual vent screw for transportation.
3. For fuel hoses that have quick disconnects, disconnect the fuel line from the engine or fuel tank when not in use.
4. Follow **Filling Fuel Tank** instructions for fueling.

Filling Fuel Tank

WARNING

Avoid serious injury or death from a gasoline fire or explosion. Use caution when filling fuel tanks. Always stop the engine and do not smoke or allow open flames or sparks in the area while filling fuel tanks.

Fill the fuel tanks outdoors away from heat, sparks, and open flames.

Remove the portable fuel tanks from the boat to fill them.

Always stop the engine before filling the tanks.

Do not completely fill the fuel tanks. Leave approximately 10% of the tank volume unfilled. Fuel will expand in volume as its temperature rises and can leak under pressure if the tank is completely filled.

PORTABLE FUEL TANK PLACEMENT IN THE BOAT

Place the fuel tank in the boat so the vent is higher than the fuel level under normal boat operating conditions.

FUEL AND OIL

Engine Oil Recommendations

We recommend the use of Mercury or Quicksilver NMMA FC-W certified 10W-30 4-Stroke Outboard Oil for general, all-temperature use. If NMMA certified synthetic blend 25W-40 4-Stroke outboard oil is preferred, use Mercury or Quicksilver synthetic blend 4-Stroke Outboard Oil. If the recommended Mercury or Quicksilver NMMA FC-W certified outboard oils are not available, a major FC-W certified 4-stroke outboard oil may be used.

IMPORTANT: The use of detergent oils, multi-viscosity oils (other than Mercury or Quicksilver NMMA FC-W certified oil or a major brand NMMA FC-W certified oil), synthetic oils, low quality or oils that contain solid additives are not recommended.

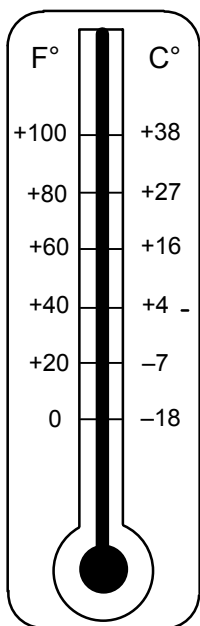

Recommended SAE viscosity for engine oil

a - NMMA FC-W certified 25W-40 4-stroke outboard oil may be used at temperatures above 4 °C (40 °F)

b - NMMA FC-W certified 10W-30 4-stroke outboard oil is recommended for use in all temperatures.

Checking And Adding Engine Oil

IMPORTANT: Do not overfill. Be sure that the outboard is upright (not tilted) when checking oil.

1. Turn the engine off. Have the outboard in a level operating position. Remove the top cowl.

FUEL AND OIL

2. Pull out the dipstick. Wipe it with a clean rag or towel and push it back in all the way.

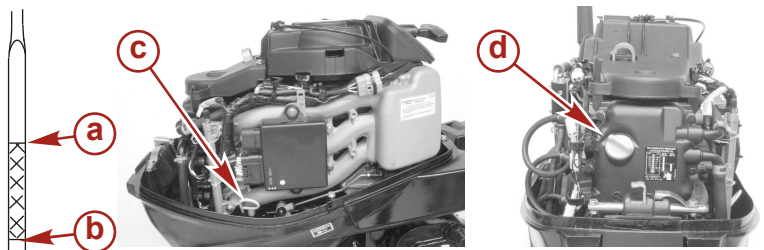

- a - Full mark
- b - Add mark
- c - Dipstick
- d - Oil fill cap

3. Pull the dipstick back out again and observe the oil level. Oil must be between full mark and add mark. If the oil level is low, remove the oil fill cap and fill to (but not over) the upper oil level.

NOTE: Under certain conditions, the operating temperature of 4-stroke outboard engines may not get hot enough to evaporate the normal fuel and moisture that accumulate in the crankcase. These conditions include operating at idle for long periods, repeated short trips, slow speed or quick stop-and-go operation, and operating in cooler climates. This additional fuel and moisture that collects in the crankcase eventually ends up in the oil sump and will add to the total volume of oil that appears on the dipstick reading. This increase in oil volume is known as oil dilution. Outboard engines can typically handle large amounts of oil dilution without causing durability problems. However, to ensure extended life of the outboard engine, Mercury recommends that the oil and filter be changed regularly following the oil change interval and using the recommended oil quality. It is further recommended that if your outboard is operated frequently in the conditions described above, that more frequent oil change intervals be considered.

FUEL AND OIL

4. Push the dipstick back in all the way. Install the oil fill cap hand tight.

FEATURES AND CONTROLS

Remote Control Features

Your boat may be equipped with one of the Mercury Precision or Quicksilver remote controls shown. If not, consult your dealer for a description of the functions and operations of the remote control.

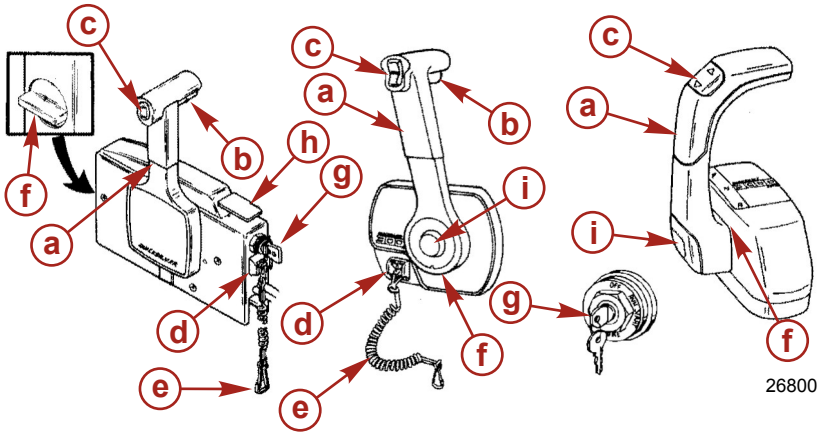

- a** - Control handle – forward, neutral, reverse
- b** - Neutral release lever
- c** - Trim/tilt switch (if equipped) – Refer to **Features and Controls – Power Trim and Tilt**
- d** - Lanyard stop switch – Refer to **General Information – Lanyard Stop Switch**
- e** - Lanyard – Refer to **General Information – Lanyard Stop Switch**
- f** - Throttle friction adjustment – Console controls require cover removal for adjustment
- g** - Ignition key switch – "OFF," "ON," "START"
- h** - Fast idle lever – Refer to **Operation – Starting the Engine**
- i** - Throttle only button – Refer to **Operation – Starting the Engine**

FEATURES AND CONTROLS

Tiller Handle Models

FEATURES

- Steering friction adjustment - Adjust this lever to achieve the desired steering friction (drag) on the tiller handle. Move the lever to the left to tighten friction or move to the right to loosen friction.

⚠ WARNING

Insufficient friction adjustment can cause serious injury or death due to loss of boat control. When setting the friction adjustment, maintain sufficient steering friction to prevent the outboard from steering into a full turn if the tiller handle or steering wheel is released.

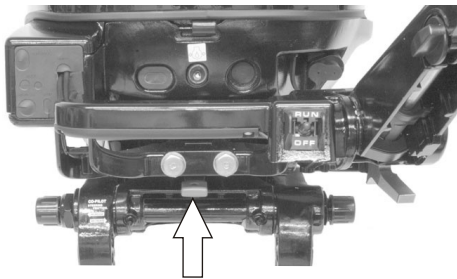

a - Tighten friction

b - Loosen friction



24830

- Warning light - The warning light will turn on, or flash, to alert the operator to the warning system situations. Refer to **Warning System**.

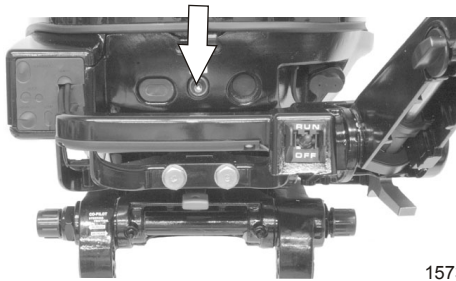

15732

FEATURES AND CONTROLS

- Electric start button (Electric start models) - Press to start the engine.

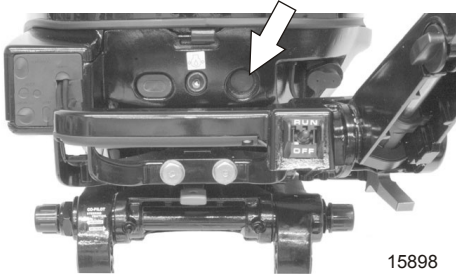

- Tiller handle - The tiller handle can be tilted 180° for convenient handling during transportation and storage.

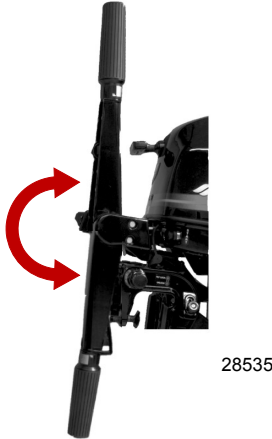

FEATURES AND CONTROLS

- Tiller lock release lever - Push the lever to move the tiller handle from one position to another.

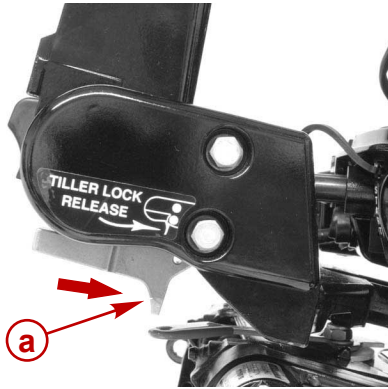

- Tiller handle lock cap - Remove the lock cap on top of the tiller handle to lock in the up position. Push the tiller lock release lever to release the handle from the locked up position.

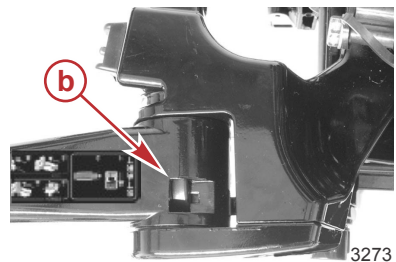
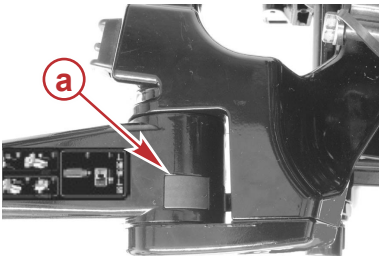

- a** - Lock cap
- b** - Locking mechanism

FEATURES AND CONTROLS

- Engine stop switch



- Throttle grip friction knob - Turn the friction knob to set and maintain the throttle at desired speed. Turn the knob clockwise to tighten the friction or turn the knob counterclockwise to loosen the friction.

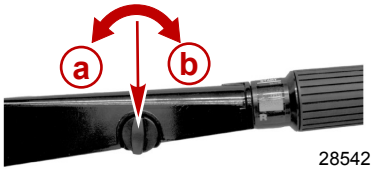

- a** - Loosen friction (counterclockwise)
- b** - Tighten friction (clockwise)

- Lanyard stop switch - Refer to **General Information - Lanyard Stop Switch**.

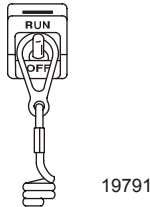

BASIC TILTING OPERATION

Models equipped with a gas assisted tilt system allows the operator to lock the outboard at any tilt position from full down to full up.

This tilt system is designed to be adjusted when the outboard is idling in neutral, or with the engine turned off.

FEATURES AND CONTROLS

Before operating, the outboard must be locked in its tilt position by moving the lock lever to the lock position.

WARNING

Operating the engine without engaging the tilt lock lever can cause serious injury or death. The outboard can tilt upwards when decelerating or operating in reverse, causing loss of boat control. Always lock the outboard in its run position before operating.

Move the lock lever to the free position. Tilt the outboard to the desired position and lock in place by moving the tilt lock lever back to the lock position.

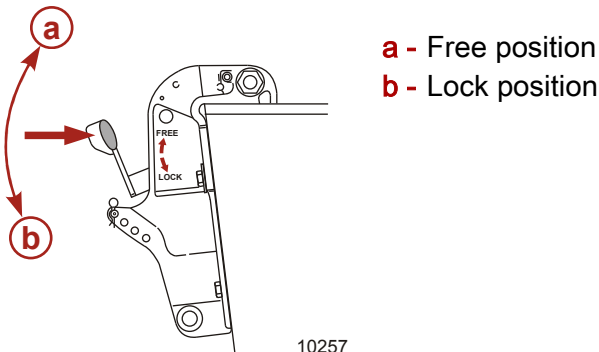

TILTING OUTBOARD TO FULL UP POSITION

1. Stop the engine. Move the lock lever to the free position. Take hold of the top cowl grip and raise the outboard to the full tilt up position. Lock the outboard in place by moving the lock lever to the lock position.

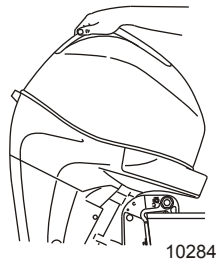

2. Engage the tilt support lever.

FEATURES AND CONTROLS

3. Lower the outboard to rest on the tilt support lever.

LOWERING OUTBOARD TO RUN POSITION

1. Move the lock lever to the free position. Tilt up the outboard slightly and release the tilt support lever. Lower the outboard to the run position.
2. Move the lock lever to the lock position.



9703

OPERATING ANGLE ADJUSTMENT

The transom brackets have four holes for adjusting the vertical operating angle (forward stop movement) of the outboard. Use the tilt pin for adjustments in the four holes.

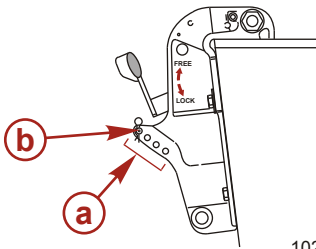

- a - Transom bracket holes
- b - Tilt pin

10290

Adjust the operating angle of the outboard so that the outboard runs perpendicular to the water when the boat is at full speed. Arrange passengers and load in the boat so the weight is distributed evenly.

NOTE: The outboard should be locked against the tilt pin during operation by setting the tilt lock lever to the lock position.

FEATURES AND CONTROLS

Power Trim and Tilt (if Equipped)

POWER TRIM AND TILT

Your outboard has a trim/tilt control called power trim. This enables the operator to easily adjust the position of the outboard by pressing the trim switch. Moving the outboard in closer to the boat transom is called trimming in or down. Moving the outboard further away from the boat transom is called trimming out or up. The term trim generally refers to the adjustment of the outboard within the first 20° range of travel. This is the range used while operating your boat on plane. The term tilt is generally used when referring to adjusting the outboard further up and out of the water. With the engine turned off, the outboard can be tilted out of the water. At low idle speed, the outboard can also be tilted up past the trim range to permit, for example, shallow water operation.

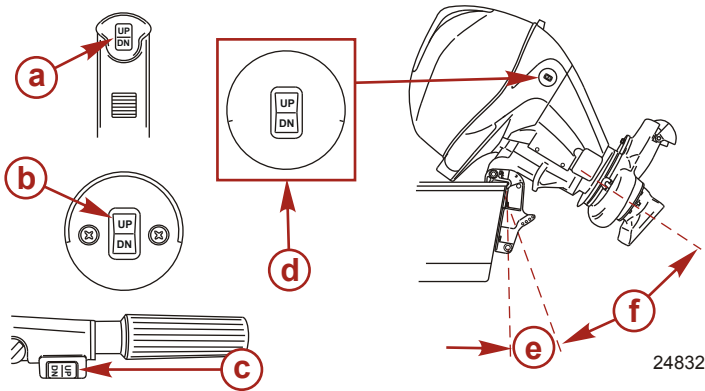

- a** - Remote control trim switch
- b** - Panel mount trim switch
- c** - Tiller handle trim switch
- d** - Cowl mounted trim switch (option)
- e** - Trim range of travel
- f** - Tilt range of travel

24832

FEATURES AND CONTROLS

POWER TRIM OPERATION

The power trim and tilt feature of the outboard is convenient for drifting and when operating at low throttle speed in very shallow water. When under power, do not trim out the outboard in an effort to gain speed as is done with a conventional propeller driven boat.

When planing, the outboard should be positioned vertical or tilted in toward the boat to provide a scooping angle on the water intake grate. Tilting the outboard out beyond a vertical position reduces the scoop angle and can cause impeller slippage and cavitation burns on the impeller blades.

TILTING OPERATION

To tilt the outboard, shut off the engine and press the trim/tilt switch or auxiliary tilt switch to the up position. The outboard will tilt up until the switch is released or it reaches its maximum tilt position.

1. Engage the tilt support lever by rotating the lever down.
2. Lower the outboard to rest on the tilt support lever.
3. Disengage the tilt support lever, by slightly tilting up the outboard and releasing the tilt support bracket. Lower the outboard.

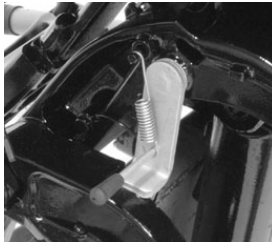

9703

MANUAL TILTING

If the outboard cannot be tilted using the power trim/tilt switch, the outboard can be manually tilted.

NOTE: *The manual tilt release valve must be tightened before operating the outboard to prevent the outboard from tilting up during reverse operation.*

FEATURES AND CONTROLS

Turn out the manual tilt release valve three turns counterclockwise. This allows manual tilting of the outboard. Tilt the outboard to the desired position and tighten the manual tilt release valve.

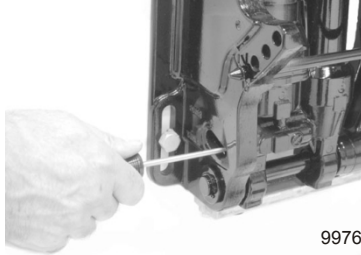

AUXILIARY TILT SWITCH

The auxiliary tilt switch can be used to tilt the outboard up or down using the power trim system.

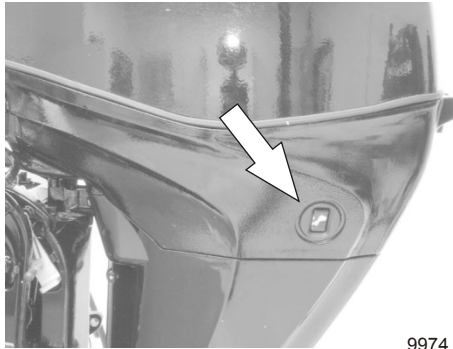

SHALLOW WATER OPERATION

When operating your boat in shallow water, you can tilt the outboard beyond the maximum trim range to prevent hitting bottom.

1. Reduce the engine speed below 2000 RPM.
2. Tilt the outboard up. Make sure all the water intake holes stay submerged at all times.
3. Operate the engine at slow speed only.

FEATURES AND CONTROLS

Warning System

WARNING HORN

Remote control models have a warning horn located inside the remote control or connected to the ignition key switch. Tiller handle models have a warning horn located in the engine cowl.

WARNING LIGHT

The warning light will turn on or flash to alert the operator to the warning system situations listed in the following chart.

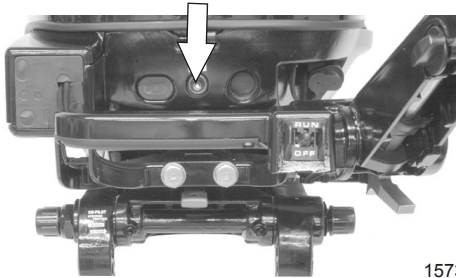

15732

WARNING SYSTEM OPERATION

The warning horn will emit either a continuous beep or intermittent short beeps and engine speed will be limited. This alerts the operator and helps identify the following listed situations.

Warning System				
Function	Sound	Warning Light	Description	Engine Speed Limited to 2800 RPM
Start up	One beep	On for 5 seconds	Normal system test	
Engine over temperature	Continuous	On	Engine overheat	X
Low oil pressure	Continuous	On	Low oil pressure	X

FEATURES AND CONTROLS

Warning System				
Function	Sound	Warning Light	Description	Engine Speed Limited to 2800 RPM
Engine overspeed	Continuous	On	Engine speed exceeds maximum allowable RPM	
Water temp or MAP sensor out of range	Intermittent short beep	Flashes	Engine speed will be limited. Consult your dealer for assistance.	X

ENGINE OVERHEAT

If the engine overheats, immediately reduce throttle speed to idle. Shift the outboard into neutral and check for a steady stream of water coming out of the water pump indicator hole.



9647

If no water is coming out of the water pump indicator hole, or flow is intermittent; stop the engine and check the cooling water intake holes for obstruction. If no obstruction is found, there may be a blockage in the cooling system or a water pump problem. Have the outboard checked by your dealer. Operating the engine while overheated will cause engine damage.

If a steady flow of water is coming out of the water pump indicator hole and the engine continues to overheat, consult your dealer. Operating an overheated engine will cause engine damage.

FEATURES AND CONTROLS

NOTE: *Should overheating occur and you are stranded, stop the engine and allow it to cool down. This will usually allow some additional low speed (idle) running time before the engine starts to overheat again.*

LOW OIL PRESSURE

The warning system is activated if the oil pressure drops too low. First, stop the engine and check the oil level. Add oil if necessary. If the oil is at the recommended level and the warning horn continues to sound, consult your dealer. Engine speed will be limited to 2800 RPM, however, you should not continue to operate the engine.

ENGINE OVERSPEED LIMITER

The outboard is equipped with an engine overspeed limiter which limits the engine maximum RPM. This protects the engine from mechanical damage.

Some causes of engine overspeed are as follows:

- Outboard mounted too high on the transom
- Worn jet pump impeller or liner
- Incorrect jet pump impeller clearance adjustment
- Tilting the outboard out beyond a vertical position
- Cavitation of the impeller due to rough water or obstruction in the boat hull
- Blockage of the water intake

When the engine overspeed limiter is activated, it will reduce ignition voltage to momentarily decrease the engine speed. Excessive overspeed (above 6300 RPM) results in cutout of the cylinders to prevent operation above this limit.

FEATURES AND CONTROLS

Replaceable Jet Drive Shear Key

The jet drive is equipped with a shear key to protect it in the event of a lodged impeller. The shear key can be reached by removing the water intake housing and impeller. Refer to **Maintenance - Impeller Removal and Installation**.

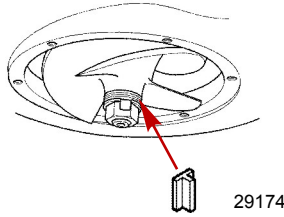

OPERATION

Pre-Starting Check List

- Operator knows safe navigation, boating, and operating procedures.
- An approved personal flotation device of suitable size for each person aboard and readily accessible (it is the law).
- A ring type life buoy or buoyant cushion designed to be thrown to a person in the water.
- Know your boats maximum load capacity. Look at the boat capacity plate.
- Fuel supply OK.
- Ensure the boat drain plug is installed.
- Arrange passengers and load in the boat so the weight is distributed evenly and everyone is seated in a proper seat.
- Tell someone where you are going and when you expect to return.
- It is illegal to operate a boat while under the influence of alcohol or drugs.
- Know the waters and area you will be boating; tides, currents, sand bars, rocks, and other hazards.
- Make inspection checks listed in **Maintenance - Inspection and Maintenance Schedule**.
- Check steering for free operation.
- Check for debris around the rudder and reverse gate which may jam or hinder operation.
- Before launching, examine the jet drive water intake for obstructions which may prevent pumping of water.
- Ensure the driveshaft bearing on the jet drive is lubricated.

Operating in Freezing Temperatures

If there is a chance of ice forming on the water, the jet drive should be removed and drained completely of water. If ice should form at the water level inside the outboard driveshaft housing, it will block water flow to the engine causing possible damage. Do not start the engine until the ice is clear.

OPERATION

Operating in Saltwater or Polluted Water

If the boat is kept moored in the water, always tilt the outboard so the water intake is completely out of water (except in freezing temperatures) when not in use.

Wash down the outboard exterior and flush out the exhaust outlet of the jet drive with fresh water after each use. Each month, spray Mercury Precision or Quicksilver Corrosion Guard on external metal surfaces.

Operating in Shallow Water

The life of the impeller and water intake can be greatly increased by avoiding the intake of sand and gravel. The intake suction will act like a dredge when the water intake comes close to the bottom. It is better to stop the engine and drift up to shore when landing, and to shove off with an oar when leaving. The engine can idle through areas of water less than 61 cm (2 ft) deep, but there should be more than 61 cm (2 ft) of water under the boat when increasing speed to reach full plane.

Once the boat is on plane, the boat speed will prevent the ingestion of gravel and other debris from the bottom. The suction is still present, but the water intake passes too quickly over the bottom to allow debris to be drawn into the water intake.

When boating through shallow water areas, choose a course of travel that avoids sharp rocks and other underwater obstacles that could damage the boat. Running the boat through these areas on full plane may be helpful as the boat will be riding higher in the water. If the boat gets stuck on the bottom, immediately stop the engine and move the boat to deeper water.

How the Jet Drive Operates

A jet driven boat has substantially different handling characteristics compared to a propeller driven boat. It is recommended that the operator adjusts to these characteristics by experimenting in open water at both high and low speeds.

OPERATION

The driveshaft driven impeller draws water up through the water intake and then directs it at a high pressure through the water outlet nozzle to create forward thrust. To obtain reverse, the reverse gate moves over the outlet nozzle to direct the water in the opposite direction.

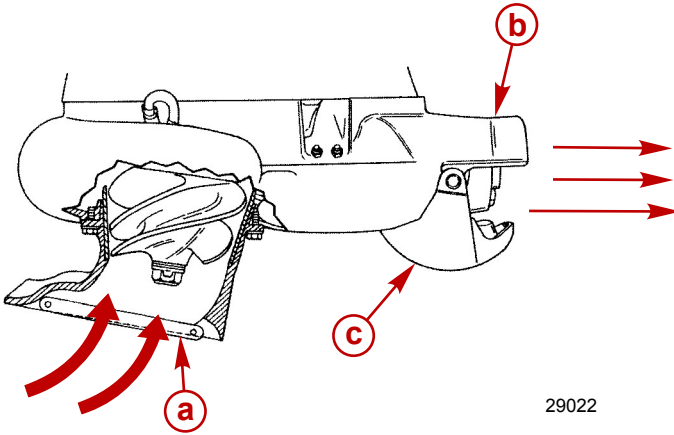

- a** - Water intake
- b** - Water outlet nozzle
- c** - Reverse gate

When the jet drive is in neutral, the impeller continues to rotate. However, the reverse gate is positioned so that some of the forward thrust is diverted to create reverse thrust. This approximate balancing of forward and reverse thrust will minimize any boat movement. Because the impeller is always rotating and creating thrust when the engine is running, the boat may tend to move slowly forward or backward. This is normal for a direct-drive jet driven boat. The operator should be aware of this and use caution whenever the engine is running.

OPERATION

WARNING

Avoid injury resulting from contacting the rotating impeller or having hair, clothing, or loose objects drawn into the water intake and wrapping around the impeller shaft. Stay away from the water intake and never insert an object into the water intake or water outlet nozzle when the engine is running.

The jet drive is always drawing water into the housing when the engine is running. Do not operate the jet drive with the grate removed from the water intake. Keep hands, feet, hair, loose clothing, life jackets, etc., away from the water intake. Never insert an object into the water intake or water outlet nozzle when the engine is running.

Stopping the Boat in an Emergency

A jet powered boat has emergency stopping capability unique to this form of propulsion.

WARNING

Using the emergency stopping capability of a jet drive unit will slow down the boat in an emergency. However, sudden stopping may cause the occupants of the boat to be thrown forward or out of the boat resulting in serious injury or death. Use caution when performing the emergency stopping procedure, and be sure to practice in a safe area.

In an emergency, putting the jet outboard into reverse and applying reverse throttle can rapidly slow down the boat and reduce stopping distance. However, such a maneuver may cause occupants in the boat to be thrown forward or possibly out of the boat.

Steering the Boat

The jet drive is dependent on water jet thrust for steering the boat. If the water jet thrust should ever stop (water blockage, engine stops, etc.), the boat will slow to a stop. However, while slowing there will be a reduced ability to steer the boat.

OPERATION

WARNING

Steering the vessel in a tight turn can result in loss of boat control. In some cases, the boat can spin out or roll over, causing serious injury or death. Avoid steering beyond the capabilities of the vessel, especially at high speeds.

WARNING

A loss or reduction in water jet thrust will directly affect boat directional control, and may result in property damage, personal injury, or death. Boat directional control can also be substantially reduced or lost altogether by a sudden loss of power such as running out of gas, quickly backing off the throttle, turning off the ignition switch, activating the lanyard stop switch, or plugging the water intake to the jet pump. Use caution when maneuvering at high speeds in areas where debris (weeds, logs, gravel, etc.) could be picked up into the jet drive. The ability to take evasive action is dependent on sufficient water jet thrust to control the boat.

While steering the boat at engine speeds above idle, the boat will respond quickly; but, due to the relatively flat-bottom hulls and lack of a gearcase in the water, the boat will tend to skid on turns. Turns must be started early and use sufficient power to maintain steering control.

Mooring the Boat

Be sure to tilt the jet drive out of the water when the boat is pulled onto a beach or tied to a dock in shallow water. Failure to do this may cause the water intake housing to fill with sand or debris and could prevent the outboard from cranking over for starting.

OPERATION

Water Intake Blockage

WARNING

A rotating impeller could cause injury if contact is made with hands, clothing, or tools. To avoid injury, keep hands and clothing away from the inlet or outlet of the jetdrive, regardless of whether the boat is in the water. Secure tools and loose items to avoid being struck by projectiles as a result of contact with the rotating impeller, and to prevent damage to the impeller.

A large amount of debris being drawn into the water intake may result in a loss of power. Intake suction holding debris against the grate will result in restricted water flow. Shutting the engine off may allow the debris to fall off the intake grate allowing full power to be restored. If debris does not fall off the intake grate, the engine must be shut off and debris physically removed from the grate.

Clearing A Lodged Impeller

WARNING

Rotating the flywheel to free a lodged impeller can accidentally start the engine, resulting in serious injury or death. Always turn the ignition key or lanyard stop switch to the "OFF" position and remove all spark plug leads from the spark plugs.

It is possible for debris to lodge between the impeller and jet housing wall, especially after the engine has been stopped. This will lock the driveshaft and will prevent the engine from being able to crank over for starting. Following are steps for dislodging the impeller.

1. Position the lanyard stop switch to the "OFF" position.
2. Remove the spark plug leads to prevent the engine from accidentally starting.
3. Remove the flywheel or rewind cover and rotate the engine flywheel counterclockwise.

OPERATION

If this does not dislodge the impeller, it will be necessary to remove the six screws and water intake housing.

Pre-Starting Instructions

1. Connect the remote fuel line to the outboard. Ensure the connector is snapped into place.



9600

2. Check the engine oil level.

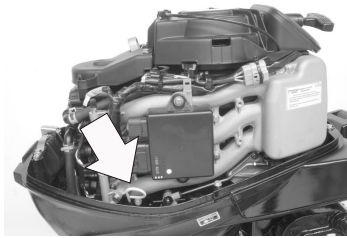

9601

3. Ensure the driveshaft bearing on the jet drive is lubricated. Refer to **Maintenance - Lubrication Points**.

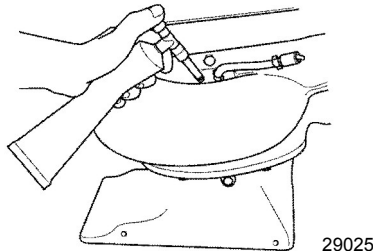

29025

OPERATION

4. Tiller handle models with manual or electric start, have a quick reference decal on the tiller handle that shows the sequence for starting the engine.



52396

Tiller handle starting sequence decal

Engine Break-in Procedure

IMPORTANT: Failure to follow the engine break-in procedures can result in poor performance throughout the life of the engine and can cause engine damage. Always follow break-in procedures.

1. For the first hour of operation, run the engine at varied throttle settings up to 3500 RPM or at approximately half throttle.
2. For the second hour of operation, run the engine at varied throttle settings up to 4500 RPM or at three-quarter throttle, and during this period of time, run it at full throttle for approximately one minute every ten minutes.
3. For the next eight hours of operation, avoid continuous operation at full throttle for more than five minutes at a time.

Starting the Engine - Remote Control Models

Before starting, read the **Pre-Starting Check List**, **Pre-Starting Instructions**, and **Engine Break-in Procedure** in the **Operation** section.

NOTICE

Without sufficient cooling water, the engine, the water pump, and other components will overheat and suffer damage. Provide a sufficient supply of water to the water inlets during operation.

OPERATION

NOTE: If the outboard runs out of fuel, or has been in storage for an extended period of time, additional attempts to start the engine are required to purge the fuel system of air.

1. Open the fuel tank vent screw (in filler cap) on manual venting type fuel tanks.

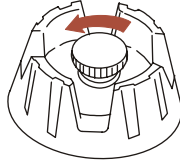

19748

2. Squeeze the fuel line primer bulb several times until it feels firm.

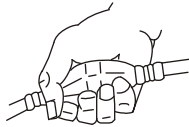

19779

IMPORTANT: To prevent engine flooding, do not squeeze the primer bulb after engine has warmed up.

3. Set the lanyard stop switch to the "RUN" position. Refer to **General Information - Lanyard Stop Switch**.



19791

OPERATION

- Shift the outboard to the neutral ("N") position.

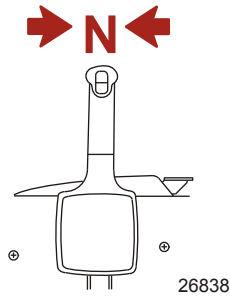

- Move the neutral fast idle speed feature to the fully closed position.

NOTE: To start a flooded engine, advance the neutral fast idle speed feature to the maximum fast idle speed position and continue to crank the engine for starting. Immediately reduce engine speed after the engine starts.

- Turn the ignition key to the "START" position. If the engine fails to start in ten seconds, return the key to the "ON" position, wait 30 seconds and try again.

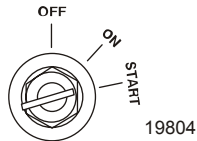

- After the engine starts, check for a steady stream of water flowing out of the water pump indicator hole.



OPERATION

IMPORTANT: If no water is coming out of the water pump indicator hole, stop the engine and check cooling water intake for obstruction. No obstruction may indicate a water pump failure or blockage in the cooling system. These conditions will cause the engine to overheat. Have the outboard checked by your dealer. Operating the engine while overheated will cause engine damage.

Starting the Engine - Tiller Handle Models

Before starting, read the **Pre-Starting Check List**, **Pre-Starting Instructions**, and **Engine Break-in Procedure** in the **Operation** section.

NOTICE

Without sufficient cooling water, the engine, the water pump, and other components will overheat and suffer damage. Provide a sufficient supply of water to the water inlets during operation.

NOTE: If the outboard runs out of fuel, or has been in storage for an extended period of time, additional attempts to start the engine are required to purge the fuel system of air.

1. Open the fuel tank vent screw (in filler cap) on manual venting type fuel tanks.

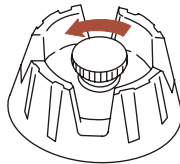

19748

2. Squeeze the fuel line primer bulb several times until it feels firm.

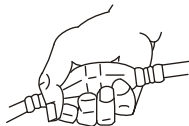

19779

OPERATION

3. Set the lanyard stop switch to the "RUN" position. Refer to **General Information - Lanyard Stop Switch**.

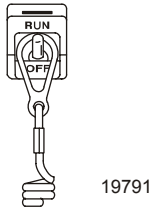

4. Set the tiller handle grip to the neutral start position.

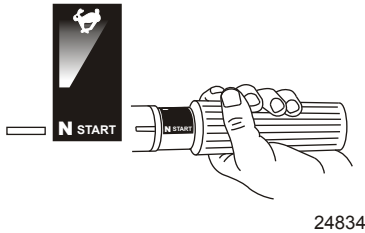

5. Set the gear shift to the neutral "N" position.

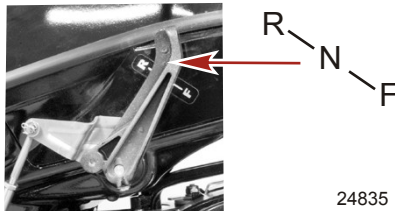

6. Position the tilt lock lever to the lock position.

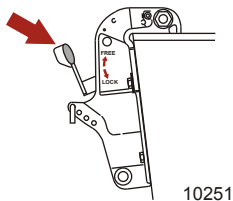

OPERATION

- Manual starting models - Pull the starter rope slowly until the starter engages, then pull rapidly to crank the engine. Allow the rope to return slowly. Repeat until the engine starts.



10173

- Electric starting models - Push the starter button and crank the engine. Release the button when the engine starts. Do not operate the starter motor continuously for longer than ten seconds at a time. If the engine fails to start in ten seconds, wait 30 seconds and try again.

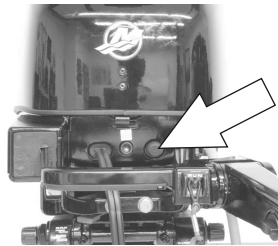

10187

- Check for a steady stream of water flowing out of the water pump indicator hole.



9647

OPERATION

IMPORTANT: If no water is coming out of the water pump indicator hole, stop engine and check cooling water intake for obstruction. No obstruction may indicate a water pump failure or blockage in the cooling system. These conditions will cause the engine to overheat. Have the outboard checked by your dealer. Operating the engine while overheated may cause serious engine damage.

Gear Shifting

NOTE: The propeller continues to rotate while the engine is in neutral. Although the approximate balancing of forward and reverse thrust will minimize boat movement, the boat may tend to move slowly forward and backward. This is normal for a direct-drive jet driven boat. The operator should be aware of this and use caution whenever the engine is running.

- The outboard has three gear shift positions to provide operation: forward (F), neutral (N), and reverse (R).
- **Tiller handle models** - Reduce the engine speed to idle before shifting.

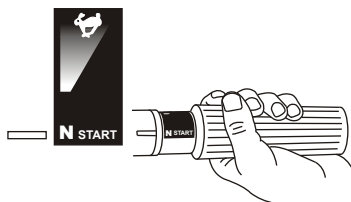

24834

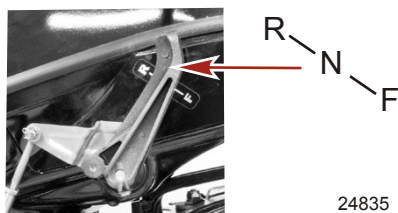

24835

OPERATION

- **Remote control models** - When shifting, always stop at the neutral position and allow the engine speed to return to idle.

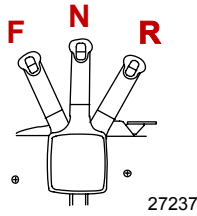

- After shifting the outboard into gear, advance the remote control lever or rotate the throttle grip (tiller handle) to increase speed.

Stopping the Engine

Reduce the engine speed and shift the outboard to neutral position. Push in the stop switch or move the lanyard stop switch to the "OFF" position.

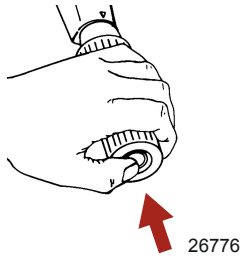

Emergency Starting

If the starter system fails, the engine can be started using the spare starter rope (provided). Refer to the following procedure for instructions.

OPERATION

1. Remove the flywheel cover or manual starter assembly.

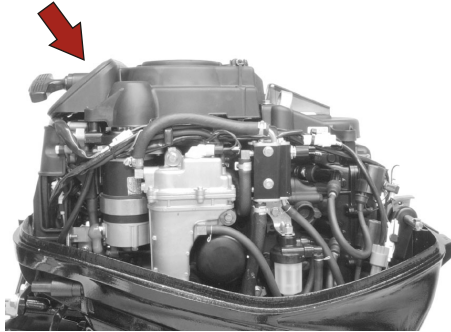

10004

2. Shift the outboard to the neutral ("N") position.

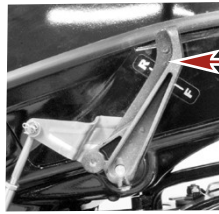
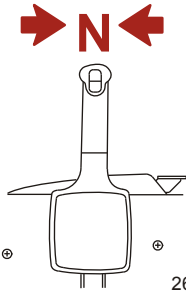

R
N
F

24835

WARNING

The neutral-speed-protection device is inoperative when starting the engine with the emergency starter rope. Set the engine speed at idle and the gear shift in neutral to prevent the outboard from starting in gear.

3. Electric start models - Turn the ignition key to the "ON" position.

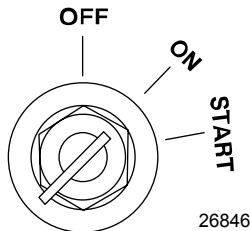

26846

OPERATION

⚠ WARNING

High voltage is present any time the key is turned on, especially when starting or operating the engine. Do not touch ignition components or metal test probes and stay clear of spark plug leads when performing live tests.

⚠ WARNING

The exposed moving flywheel can cause serious injury. Keep your hands, hair, clothing, tools, and other objects away from engine when starting or running the engine. Do not attempt to reinstall the flywheel cover or top cowl when engine is running.

4. Place the starter rope knot into the flywheel notch and wind the rope clockwise around the flywheel.
5. Pull the starter rope to start the engine.

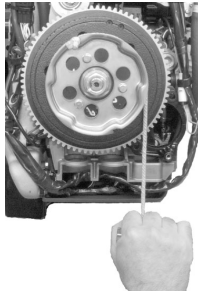

10006

MAINTENANCE

Outboard Care

To keep your outboard in the best operating condition, it is important that your outboard receive the periodic inspections and maintenance listed in the **Inspection and Maintenance Schedule**. We urge you to keep it maintained properly to ensure the safety of you and your passengers, and retain its dependability.

Record maintenance performed in the **Maintenance Log** at the back of this book. Save all maintenance work orders and receipts.

SELECTING REPLACEMENT PARTS FOR YOUR OUTBOARD

We recommend using original Mercury Precision or Quicksilver replacement parts and Genuine Lubricants.

EPA Emission Regulations

All new outboards manufactured by Mercury Marine are certified to the United States Environmental Protection Agency, as conforming to the requirements of the regulations for the control of air pollution from new outboard motors. This certification is contingent on certain adjustments set to factory standards. For this reason, the factory procedure for servicing the product must be strictly followed and, wherever practicable, returned to the original intent of the design. **Maintenance, replacement, or repair of the emission control devices and systems may be performed by any marine spark ignition (SI) engine repair establishment or individual.**

MAINTENANCE

EMISSION CERTIFICATION LABEL

An emission certification label, showing emission levels and engine specifications directly related to emissions, is placed on the engine at time of manufacture.

The image shows a rectangular emission certification label for Mercury Marine. The label is divided into several sections. At the top, it says "EMISSION CONTROL INFORMATION". Below this, there is a line for "THIS ENGINE CONFORMS TO" with a checkbox for "CALIFORNIA AND U.S. EPA EMISSION REGULATIONS FOR SPARK IGNITION MARINE ENGINES. REFER TO OWNER'S MANUAL FOR REQUIRED MAINTENANCE SPECIFICATIONS AND ADJUSTMENTS. PLEASE PERFORM THE ENGINE MAINTENANCE CORRECTLY." Below this are several fields for engine specifications: "DISPLACEMENT:", "FAMILY:", "FEL: HC+NOx=", "CO=", "HP:", "LOW-PERM/HIGH-PERM:", "MAXIMUM POWER:", "TIMING:", and "IDLE SPEED (IN GEAR):". The label also features a calendar grid on the left and right sides, with months from JAN to DEC. Red callout letters (a-h) point to specific fields: 'a' points to the displacement field, 'b' to the maximum emission output field, 'c' to the fuel line permeation field, 'd' to the timing field, 'e' to the family number field, 'f' to the engine family description field, 'g' to the engine power field, and 'h' to the idle speed field. The brand name "MERCURY MARINE" is printed at the bottom of the label.

43058

- a** - Piston displacement
- b** - Maximum emission output for the engine family
- c** - Percent of fuel line permeation
- d** - Timing specification
- e** - Family number
- f** - Engine family description
- g** - Engine power - kilowatts
- h** - Idle speed

OWNER RESPONSIBILITY

The owner/operator is required to have routine engine maintenance performed to maintain emission levels within prescribed certification standards.

The owner/operator is not to modify the engine in any manner that would alter the horsepower or allow emission levels to exceed their predetermined factory specifications.

Inspection and Maintenance Schedule

BEFORE EACH USE

- Check the engine oil level. See **Fuel and Oil - Checking and Adding Engine Oil**.
- Check that the lanyard stop switch stops the engine.

MAINTENANCE

- Visually inspect the fuel system for deterioration or leaks.
- Check the outboard for tightness on the transom.
- Check the steering system for binding or loose components.
- Visually check the steering link rod fasteners for proper tightness. See **Steering Link Rod Fasteners**.
- Make sure the driveshaft bearing on the jet drive is lubricated. See **Lubrication Points**.

AFTER EACH USE AND AFTER EVERY 10 HOURS OF OPERATION

- Lubricate the driveshaft bearing on the jet drive. See **Lubrication Points**.

AFTER EACH USE

- If operating in saltwater, wash off all salt deposits and flush out the exhaust outlet on the jet drive with fresh water.

EVERY 100 HOURS OF USE OR ONCE YEARLY, WHICHEVER OCCURS FIRST

- Lubricate all lubrication points. Lubricate more frequently when used in saltwater. See **Lubrication Points**.
- Change the engine oil and replace the oil filter. The oil should be changed more often when the engine is operated under adverse conditions such as extended trolling. See **Changing Engine Oil**.
- Replace the spark plugs at first 100 hours or first year. After that, inspect the spark plugs every 100 hours or once yearly. Replace the spark plugs as needed. See **Spark Plug Inspection and Replacement**.
- Inspect the thermostat visually for corrosion and/or a broken spring. Make sure the thermostat closes completely at room temperature.¹
- Check the engine low pressure fuel filter for contaminants. See **Fuel System**.
- Replace the high pressure fuel filter.¹
- Check the engine timing setup.¹

1. These items should be serviced by an authorized dealer.

MAINTENANCE

- Check the corrosion control anodes. Check more frequently when used in saltwater. See **Corrosion Control Anode**.
- Lubricate the splines on the driveshaft.¹
- Check and adjust valve clearance, if necessary.¹
- Check the power trim fluid. See **Checking Power Trim Fluid**.
- Inspect the battery. See **Battery Inspection**.
- Check the control cable adjustments.¹
- Inspect the timing belt. See **Timing Belt Inspection**.
- Check the tightness of bolts, nuts, and other fasteners.
- Check the cowl seals to make sure seals are intact and not damaged.
- Check the internal cowl sound reduction foam (if equipped) to make sure foam is intact and not damaged.
- Check that the intake silencer (if equipped) is in place.
- Check that the idle relief muffler (if equipped) is in place.
- Check for loose hose clamps and rubber boots (if equipped) on the air intake assembly.

Top Cowl Removal and Installation

REMOVAL

1. Unlock the rear latch by pulling lever up.



10190

MAINTENANCE

2. Lift rear of cowl and disengage front hook.



10191

INSTALLATION

1. Lower the top cowl over the engine. Bring the front of the cowl down first and engage the front hook, then lower the cowl into its seated position with the bottom cowl.
2. Apply some downward pressure on the bottom cowl and then lock the cowl in place by pushing in the cowl latch. Ensure the top cowl is securely fastened by pulling up on the back of the cowl.

Exterior Care

Your outboard is protected with a durable baked enamel finish. Clean and wax often using marine cleaners and waxes.

Worn/Dull Impeller

The intake of gravel through the pump can round off and wear the leading edges of the impeller. Some conditions that could be experienced from a worn/dull impeller are as follows:

- Noticeable performance loss, especially on acceleration
- Difficulty getting the boat on plane
- An increase in engine RPM at wide-open throttle

IMPORTANT: Do not sharpen or alter the top side lifting angle.

MAINTENANCE

Check the impeller blades occasionally for damage. Use a flat file to sharpen the leading edges. Sharpen to a 0.8 mm (1/32 in.) radius by removing material from bottom side only.

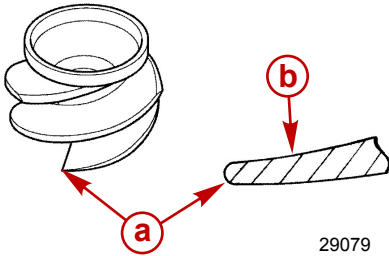

- a - Leading edge
- b - Top side lifting angle

29079

Impeller Clearance Adjustment

The impeller should be adjusted so there is approximately 0.8 mm (0.03 in.) clearance between the impeller edge and liner. Operating the jet drive in waters that contain sand and gravel can cause wear to the impeller blades, and the clearance will start to exceed 0.8 mm (0.03 in.).

As the blades wear, shims located in the stack outside of the impeller can be transferred behind the impeller. This will move the impeller further down into the tapered liner to reduce the clearance.

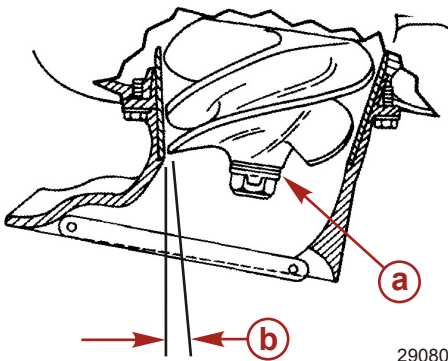

- a - Shims
- b - Clearance between impeller edge and liner

29080

Check the impeller clearance by sliding a feeler gauge through the intake grate and measure the clearance between the impeller edge and liner. If adjustment is required, refer to **Impeller Removal and Installation**.

MAINTENANCE

Impeller Removal and Installation

WARNING

Rotating the driveshaft may cause the engine to crank over and start. To prevent this type of accidental engine starting and possible serious injury caused from being struck by a rotating impeller, always turn the ignition key or lanyard stop switch to the "OFF" position and remove the spark plug leads from the spark plugs while servicing the impeller.

1. Shift the outboard to the neutral position.

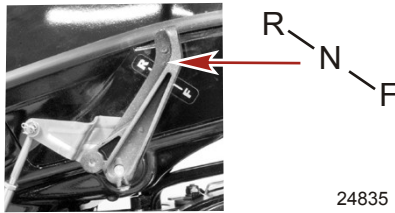

2. Position the key switch or lanyard stop switch to the "OFF" position.
3. Remove the spark plug leads to prevent the engine from starting.

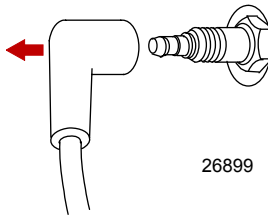

MAINTENANCE

4. Remove the six screws securing the water intake housing, and remove the water intake housing.

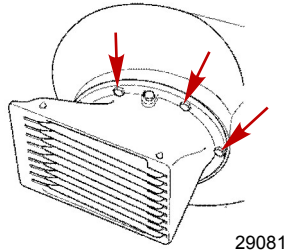

5. Straighten the bent tabs on the impeller nut retainer and remove the impeller nut.

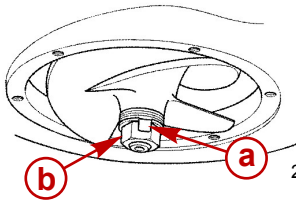

- a** - Tabs
- b** - Impeller nut

6. Pull the impeller straight off the shaft. If the impeller is tight, use a hammer and a block of wood to rotate the impeller clockwise on the shaft until the keyway is directly above the flat on the shaft. This will free the jammed key and allow removal.

INSTALLATION

1. Lubricate the driveshaft, shear key, and impeller bore.

MAINTENANCE

2. Place the plastic sleeve inside the impeller and install impeller, shear key, shims, nut retainer, and impeller nut.

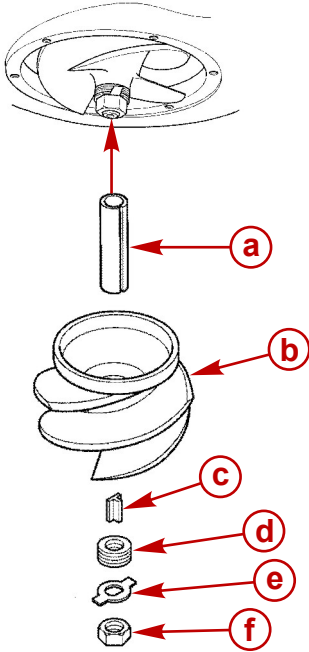

- a - Plastic sleeve
- b - Impeller
- c - Shear key
- d - Shims
- e - Nut retainer
- f - Impeller nut

29083

3. Turn the nut tight on the shaft to remove any play between the impeller and shaft. If the tabs on the retainer do not line up with the flats on the nut, remove the nut and turn the retainer over and tighten the nut again.

MAINTENANCE

4. Temporarily install the water intake housing in order to check for impeller clearance. The clearance between the impeller and liner should be 0.8 mm (0.03 in.). Shim washers can be transferred to either side of the impeller to raise or lower the impeller to the correct clearance setting. The water intake housing can be shifted sideways a small amount in order to center the liner.

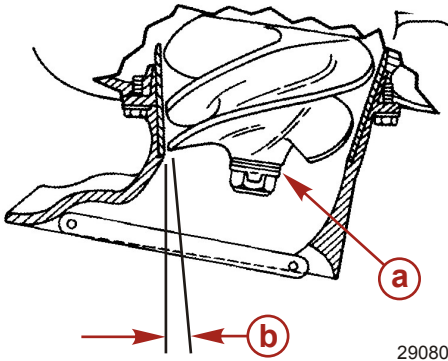

- a** - Shims
b - Clearance between impeller edge and liner

29080

5. After setting the impeller height, tighten the impeller nut snug with a wrench. Secure impeller nut by bending tabs against the flats on the impeller nut.

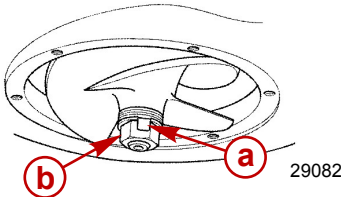

- a** - Tabs
b - Impeller nut

29082

NOTE: If the outboard is used in saltwater, apply Extreme Grease around the entire mounting flange on the water intake housing and also to the threads on the six mounting bolts.

Tube Ref No.	Description	Where Used	Part No.
	Extreme Grease	Water intake housing mounting flange and mounting bolts	8M0071842

MAINTENANCE

6. Install the water intake housing with six bolts. Check clearance around the impeller to ensure the water intake housing is centered and not rubbing against the liner. Tighten the mounting bolts to the specified torque.

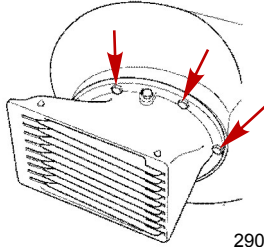

Description	Nm	lb-in.	lb-ft
Water intake housing mounting bolts	13	120	–

Shift Link Rod Adjustment

⚠ WARNING

Pressurized water hitting the reverse gate may cause it to engage, causing sudden and unexpected slowing of the boat. This can cause serious injury or death from occupants being thrown within or out of the boat. Adjust the shift link rod to lock the reverse gate, preventing it from interfering with water flow.

MAINTENANCE

CHECKING SHIFT LINK ROD ADJUSTMENT

Check the shift link rod adjustment in forward shift position. The correct adjustment will position the shift cam far enough on the roller in order to lock the reverse gate into forward position. The reverse gate should not be able to be forced up towards neutral. Pull on the reverse gate by hand to verify.

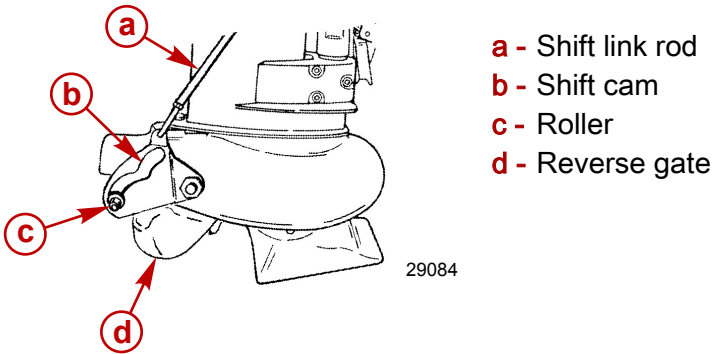

ADJUSTING SHIFT LINK ROD

1. Place the shift handle into full forward shift position.
2. Adjust the length of the shift link rod so the roller is at the full end of travel (bottom) in the shift cam when the shift handle is in forward.

Battery Inspection

The battery should be inspected at periodic intervals to ensure proper engine starting capability.

IMPORTANT: Read the safety and maintenance instructions which accompany your battery.

1. Turn off the engine before servicing the battery.
2. Ensure the battery is secure against movement.
3. Battery cable terminals should be clean, tight, and correctly installed. Positive to positive and negative to negative.
4. Ensure the battery is equipped with a nonconductive shield to prevent accidental shorting of battery terminals.

MAINTENANCE

Fuel System

WARNING

Fuel is flammable and explosive. Ensure that the key switch is off and the lanyard is positioned so that the engine cannot start. Do not smoke or allow sources of spark or open flame in the area while servicing. Keep the work area well ventilated and avoid prolonged exposure to vapors. Always check for leaks before attempting to start the engine, and wipe up any spilled fuel immediately.

Before servicing any part of the fuel system, stop the engine and disconnect the battery. Drain the fuel system completely. Use an approved container to collect and store fuel. Wipe up any spillage immediately. Material used to contain spillage must be disposed of in an approved receptacle. Any fuel system service must be performed in a well ventilated area. Inspect any completed service work for sign of fuel leakage.

FUEL LINE INSPECTION

Visually inspect the fuel line and primer bulb for cracks, swelling, leaks, hardness, or other signs of deterioration or damage. If any of these conditions are found, the fuel line or primer bulb must be replaced.

FUEL FILTER (LOW PRESSURE)

Check the fuel filter for water accumulation or sediment. If water is in the fuel, remove the sight bowl and drain the water. If the filter appears to be contaminated, remove and replace.

REMOVAL

1. Read the **Fuel System** servicing information and **Warning**, preceding.
2. Loosen the hex nut and remove the filter assembly from the mount. Hold on to the cover to prevent it from turning and remove the sight bowl. Empty the contents into an approved container.

MAINTENANCE

3. Inspect the filter element. If replacement is necessary, replace the filter assembly.

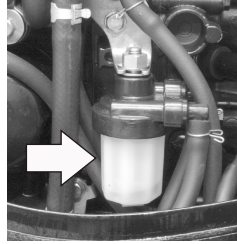
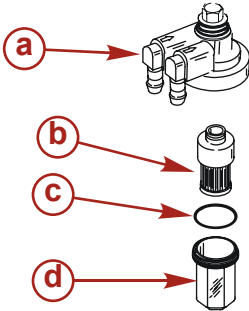

9694

- a - Cover
- b - Filter element
- c - O-ring seal
- d - Sight bowl

INSTALLATION

1. Push the filter element into the cover.
2. Place the O-ring seal into its proper position on the sight bowl and screw the sight bowl hand-tight into the cover.
3. Install the filter assembly back into the mount.

IMPORTANT: Visually inspect for fuel leakage from the filter by squeezing the primer bulb until firm, forcing fuel into the filter.

Steering Link Rod Fasteners

IMPORTANT: The steering link rod that connects the steering cable to the engine must be fastened using the steering link rod fastening hardware supplied with engine. Never replace the locknuts (11-16147-3) with common nuts (non-locking) as they will work loose and vibrate off, freeing the link rod to disengage.

MAINTENANCE

⚠ WARNING

Improper fasteners or improper installation procedures can result in loosening or disengagement of the steering link rod. This can cause a sudden, unexpected loss of boat control, resulting in serious injury or death due to occupants being thrown within or out of the boat. Always use required components and follow instructions and torque procedures.

Assemble steering link rod to steering cable with flat washer and nylon insert locknut. Tighten locknut until it seats, then back nut off 1/4 turn.

Assemble steering link rod to engine with bolt, locknut, spacer, and flat washers. Tighten the locknut to the specified torque.

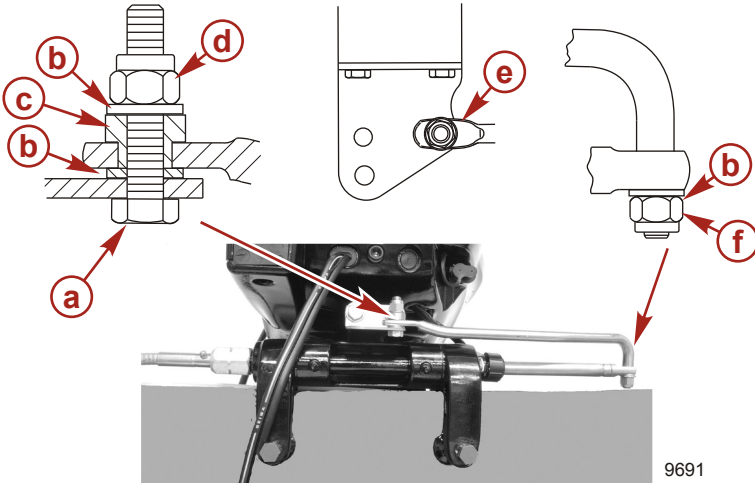

- a** - Bolt (10-898101018)
- b** - Flat washer (12-95392-10)
- c** - Spacer (23-853826001)
- d** - Nylon insert locknut (11-16147--3)
- e** - Install steering link rod into side hole
- f** - Nylon insert locknut (11-16147--3) (tighten until it seats, then back off 1/4 turn)

MAINTENANCE

Description	Nm	lb-in.	lb-ft
Nylon insert locknut "d"	27	–	20
Nylon insert locknut "f"	Tighten until it seats, then back off ¼ turn		

Corrosion Control Anode

Your outboard has corrosion control anodes at different locations. An anode helps protect the outboard against galvanic corrosion by sacrificing its metal to be slowly corroded instead of the outboard metals.

Each anode requires periodic inspection, especially in saltwater which will accelerate the erosion. To maintain this corrosion protection, always replace the anode before it is completely eroded. Never paint or apply a protective coating on the anode as this will reduce effectiveness of the anode.

One anode is installed in the engine block. Remove the anode at the location shown. Fasten the anode to the cover with a bolt. Tighten the bolt to the specified torque. Install the cover with new gasket. Tighten the bolts to the specified torque.

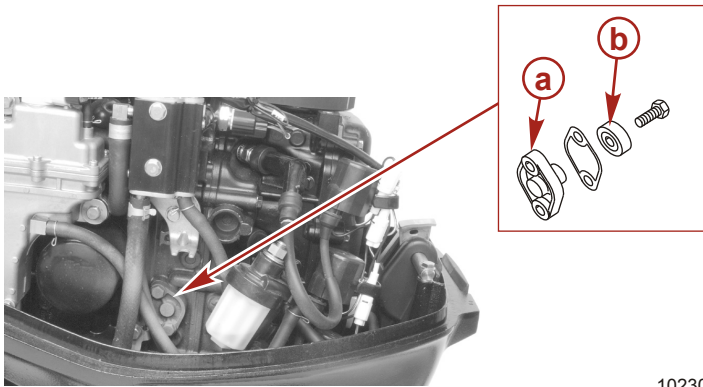

10230

- a** - Cover
- b** - Anode

Description	Nm	lb. in.	lb. ft.
Anode bolt	8	71	

MAINTENANCE

Description	Nm	lb. in.	lb. ft.
Cover bolt (2)	8	71	

The second anode is on the water intake housing and the third anode is installed on the transom brackets.

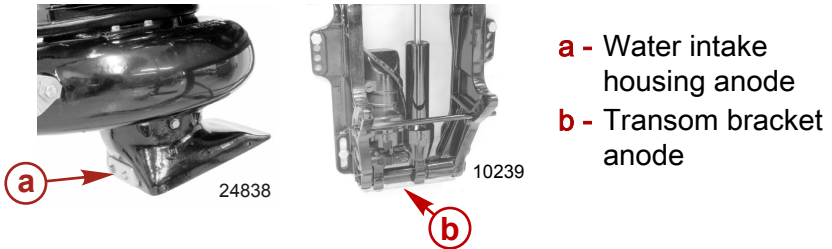

Spark Plug Inspection and Replacement

⚠ WARNING

Damaged spark plug boots may emit sparks that can ignite fuel vapors under the engine cowl, resulting in serious injury or death from a fire or explosion. To avoid damaging the spark plug boots, do not use any sharp object or metal tool to remove the spark plug boots.

1. Remove the spark plug leads. Twist the rubber boots slightly and pull off.

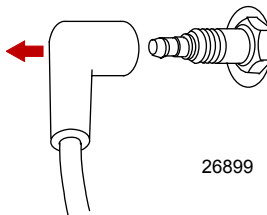

MAINTENANCE

- Remove the spark plugs to inspect. Replace spark plug if electrode is worn or the insulator is rough, cracked, broken, blistered, or fouled.

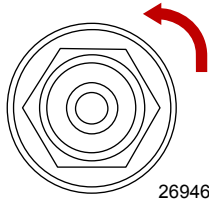

- Set the spark plug gap to specifications.

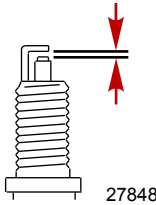

Spark Plug Gap	
Spark plug	0.80–0.90 mm (0.031–0.035 in.)

- Before installing spark plugs, clean off any dirt on the spark plug seats. Install plugs finger-tight, and then tighten to the specified value.

Description	Nm	lb. in.	lb. ft.
Spark plug	20		14

Fuse Replacement - Electric Start Models

IMPORTANT: Always carry spare SFE 20 amp fuses.

The electric starting circuit is protected from overload by an SFE 20 amp fuse. If the fuse is blown, the electric starter motor will not operate. Try to locate and correct the cause of the overload. If the cause is not found, the fuse may blow again.

MAINTENANCE

Open the fuse holder and look at the silver colored band inside the fuse. If band is broken, replace the fuse. Replace fuse with a new fuse with the same rating.

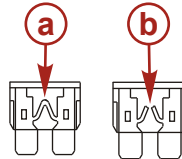
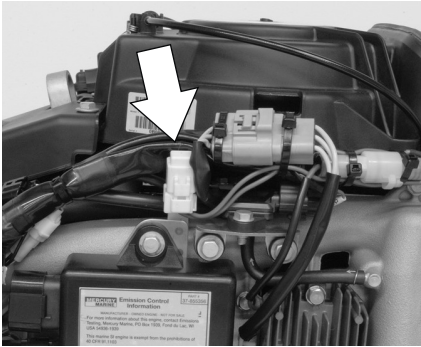

15917

- a** - Good fuse
- b** - Blown fuse

Timing Belt Inspection

Inspect the timing belt and have it replaced by an authorized dealer if any of the following conditions are found.

- Cracks in the back of the belt or in the base of the belt teeth.
- Excessive wear at the roots of the cogs.
- Rubber portion swollen by oil.
- Belt surfaces roughened.
- Signs of wear on edges or outer surfaces of belt.

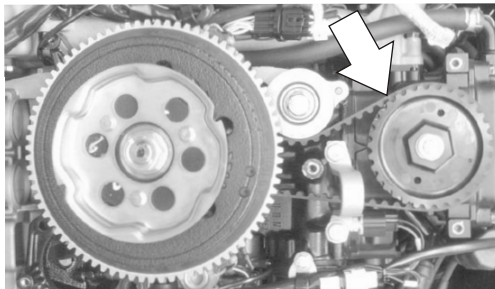

9697

MAINTENANCE

Lubrication Points

1. Lubricate the following with Extreme Grease or 2-4-C with PTFE.

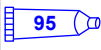
Tube Ref No.	Description	Where Used	Part No.
	Extreme Grease	Driveshaft bearing	8M0071842
	2-4-C with PTFE	Driveshaft bearing	92-802859A 1

- Driveshaft bearing

IMPORTANT: It is important not to use a general all purpose grease for this bearing. The lubricant recommended is a water resistant grease of the proper consistency for this application. If a substitute is used, be sure that it is water resistant and of the same consistency.

- i. Pull the vent hose off of the grease fitting.
- ii. Pump in grease through the grease fitting, using the grease gun provided, until excess grease starts to exit the vent hose.
- iii. Reconnect the vent hose onto the grease fitting after greasing.

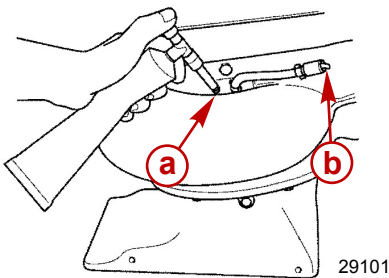

- a** - Grease fitting
- b** - Vent hose

MAINTENANCE

NOTE: After 30 hours of operation, pump in extra grease to purge out any moisture. Visually inspecting the purged grease at this time will give an indication of conditions inside the bearing housing. A gradual increase in moisture content, indicates seal wear. If the grease begins to turn dark or dirty gray, the driveshaft bearing and seals should be inspected and replaced if necessary. Some discoloration of the grease is normal during the break-in period on a new set of seals.

2. Lubricate the following with 2-4-C with PTFE or Extreme Grease.

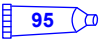
Tube Ref No.	Description	Where Used	Part No.
	Extreme Grease	Swivel bracket, tilt tube, transom clamp screws, steering cable grease fitting	8M0071842
	2-4-C with PTFE	Swivel bracket, tilt tube, transom clamp screws, steering cable grease fitting	92-802859A 1

- Swivel bracket - Lubricate through fitting.

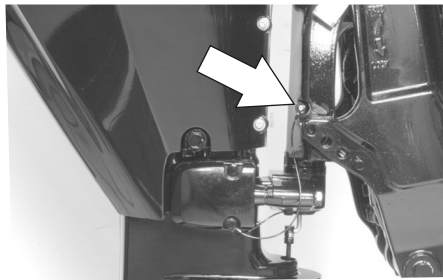

24839

MAINTENANCE

- Tilt tube - Lubricate through fittings.

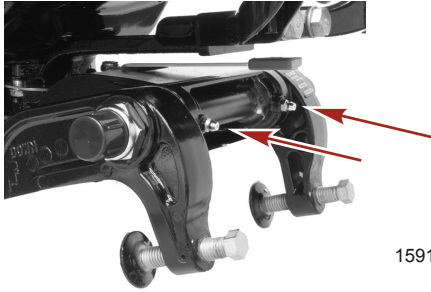

- Lubricate the threads on the transom clamp screws (if equipped).

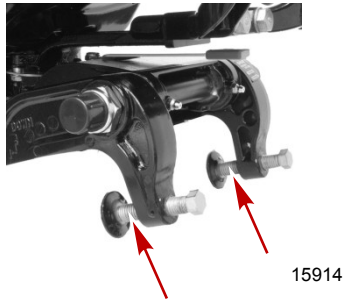

- Steering cable grease fitting (If equipped) - Rotate the steering wheel to fully retract the steering cable end into the outboard tilt tube. Lubricate through fitting.

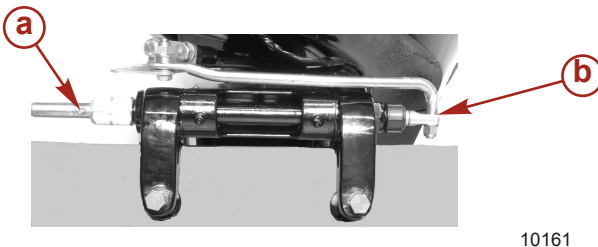

- a** - Fitting
- b** - Steering cable end

MAINTENANCE

⚠ WARNING

Incorrect cable lubrication can cause hydraulic lock, leading to serious injury or death from loss of boat control. Completely retract the end of the steering cable before applying lubricant.

3. Lubricate the following with light weight oil.
 - Steering link rod pivot points - Lubricate the pivot points.

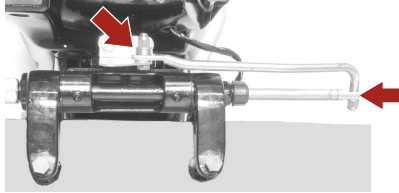

10164

Checking Power Trim Fluid

1. Tilt the outboard to the full up position and engage the tilt support lock.



9703

MAINTENANCE

- Remove the fill cap and check the fluid level. The fluid level should be even with the bottom of the fill hole. Add Quicksilver or Mercury Precision Lubricants Power Trim & Steering Fluid. If not available, use automotive (ATF) automatic transmission fluid.

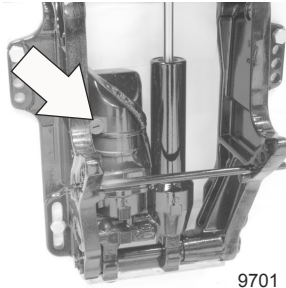

9701

Tube Ref No.	Description	Where Used	Part No.
 114	Power Trim and Steering Fluid	Power trim system	92-858074K01

Changing Engine Oil

ENGINE OIL CAPACITY

	Capacity	Fluid Type
Engine oil	1.8 liter (1.9 quarts)	Mercury Precision Parts or Quicksilver 10W-30 4-Stroke Outboard Oil
		Mercury Precision Parts or Quicksilver Synthetic Blend 4-Stroke Outboard Oil

OIL CHANGING PROCEDURE

- Tilt the outboard up to the trailer position.

MAINTENANCE

2. Turn the steering on the outboard so that the drain hole is facing downward. Remove the drain plug and drain the engine oil into an appropriate container. Lubricate the seal on the drain plug with oil and install.

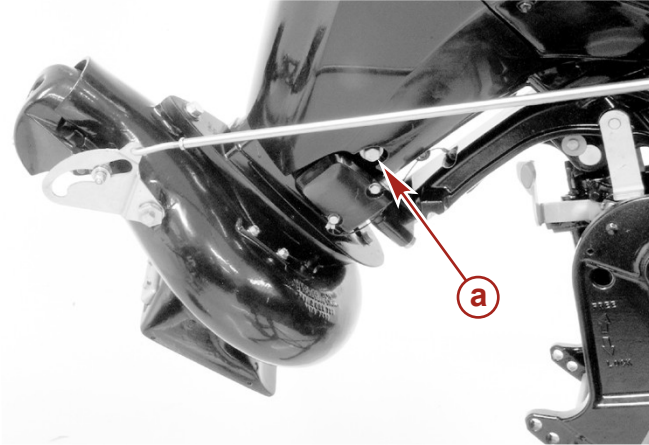

24854

a - Drain plug

CHANGING OIL FILTER

1. Place a rag or towel below the oil filter to absorb any spilled oil.
2. Unscrew the old filter by turning the filter to the left.

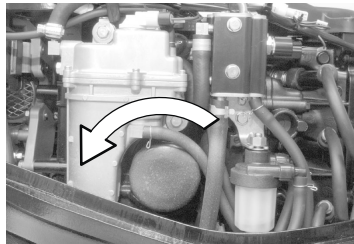

9735

3. Clean the mounting base. Apply a film of clean oil to the filter gasket. Do not use grease. Screw the new filter on until the gasket contacts the base, then tighten 3/4 to 1 turn.

MAINTENANCE

OIL FILLING

1. Remove the oil fill cap and add oil to the proper operating level.
2. Idle the engine for five minutes and check for leaks. Stop the engine and check oil level on the dipstick. Add oil if necessary.

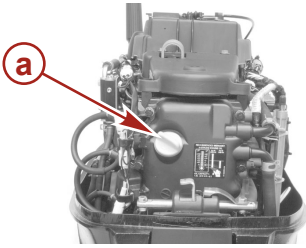

a - Oil fill cap

9737

Submerged Outboard

A submerged outboard will require service within a few hours by an authorized dealer once the outboard is recovered from the water. This immediate attention by a servicing dealer is necessary once the engine is exposed to the atmosphere to minimize internal corrosion damage to the engine.

STORAGE

Storage Preparation

The major consideration in preparing your outboard for storage is to protect it from rust, corrosion, and damage caused by freezing of trapped water.

The following storage procedures should be followed to prepare your outboard for out of season storage or prolonged storage (two months or longer).

NOTICE

Without sufficient cooling water, the engine, the water pump, and other components will overheat and suffer damage. Provide a sufficient supply of water to the water inlets during operation.

FUEL SYSTEM

IMPORTANT: Gasoline containing alcohol (ethanol or methanol) can cause a formation of acid during storage and can damage the fuel system. If the gasoline being used contains alcohol, it is advisable to drain as much of the remaining gasoline as possible from the fuel tank, remote fuel line, and engine fuel system.

Fill the fuel tank and engine fuel system with treated (stabilized) fuel to help prevent formation of varnish and gum. Proceed with following instructions.

- Portable fuel tank - Pour the required amount of gasoline stabilizer (follow instructions on container) into fuel tank. Tip fuel tank back and forth to mix stabilizer with the fuel.
- Permanently installed fuel tank - Pour the required amount of gasoline stabilizer (follow instructions on container) into a separate container and mix with approximately one quart (one liter) of gasoline. Pour this mixture into fuel tank.
- Place the outboard in water for circulating cooling water. Run the engine for ten minutes to fill the engine fuel system.

Protecting External Outboard Components

- Lubricate all outboard components listed in **Maintenance - Inspection and Maintenance Schedule**.

STORAGE

- Touch up any paint nicks. See your dealer for touch-up paint.
- Spray Quicksilver or Mercury Precision Lubricants Corrosion Guard on external metal surfaces (except corrosion control anodes).

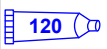
Tube Ref No.	Description	Where Used	Part No.
 120	Corrosion Guard	External metal surfaces	92-802878 55

Protecting Internal Engine Components

- Remove the spark plugs and inject a small amount of engine oil inside of each cylinder.
- Rotate the flywheel manually several times to distribute the oil in the cylinders. Install the spark plugs.
- Change the engine oil.

Jet Drive

- Pump extra grease into the jet drive bearing to purge out moisture.

Positioning Outboard for Storage

Store outboard in an upright (vertical) position to allow water to drain out of the outboard.

NOTICE

Storing the outboard in a tilted position can damage the outboard. Water trapped in the cooling passages or rain water collected in the propeller exhaust outlet in the gearcase can freeze. Store the outboard in the full down position.

Battery Storage

- Follow the battery manufacturer's instructions for storage and charging.
- Remove the battery from the boat and check water level. Charge if necessary.
- Store the battery in a cool, dry place.

STORAGE

- Periodically check the water level and charge the battery during storage.

TROUBLESHOOTING

Starter Motor will not Crank the Engine (Electric Start Models)

POSSIBLE CAUSES

- Blown fuse in the starting circuit. Refer to **Maintenance** section.
- Outboard is not shifted to neutral position.
- Weak battery or battery connections are loose or corroded.
- Ignition key switch failure.
- Wiring or electrical connection faulty.
- Starter motor or starter solenoid failure.
- Impeller is stuck due to blockage.

Engine Will Not Start

POSSIBLE CAUSES

***NOTE:** If the outboard has run out of fuel, or has been in storage for an extended period of time, additional attempts to start the engine will be required to purge the fuel system of air.*

- Lanyard stop switch not in "RUN" position.
- Incorrect starting procedure. Refer to **Operation** section.
- Old or contaminated gasoline.
- Engine flooded. Refer to **Operation** section.
- Fuel is not reaching the engine.
 - Fuel tank is empty.
 - Fuel tank vent not open or restricted.
 - Fuel line is disconnected or kinked.
 - Primer bulb not squeezed.
 - Primer bulb check valve is faulty.
 - Fuel filter is obstructed. Refer to **Maintenance** section.
 - Fuel pump failure.
 - Fuel tank filter obstructed.
- Open 20 Amp fuse. Refer to **Maintenance** section.
- Ignition system component failure.
- Wiring or electrical connection faulty.

TROUBLESHOOTING

- Spark plugs fouled or defective. Refer to **Maintenance** section.

Engine Runs Erratically

POSSIBLE CAUSES

- Overheating - Warning horn not working.
- Low oil pressure. Check oil level.
- Spark plugs fouled or defective. Refer to **Maintenance** section.
- Incorrect setup and adjustments.
- Fuel is being restricted to the engine.
 - a. Engine fuel filter is obstructed. Refer to **Maintenance** section.
 - b. Fuel tank filter obstructed.
 - c. Stuck anti-siphon valve located on permanently built-in type fuel tanks.
 - d. Fuel line is kinked or pinched.
- Fuel pump failure.
- Ignition system component failure.

Engine Overspeed (Excessive RPM)

POSSIBLE CAUSES

- Outboard mounted too high on the transom.
- Worn jet pump impeller or liner.
- Incorrect jet pump impeller clearance adjustment.
- Tilting the outboard out beyond a vertical position.
- Cavitation of the impeller due to rough water or obstruction in the boat hull.
- Blockage of the water intake.

Performance Loss

POSSIBLE CAUSES

- Throttle not fully open.
- Damaged impeller.

TROUBLESHOOTING

- Incorrect engine timing, adjustments, or setup.
- Boat overloaded or load improperly distributed.
- Excessive water in bilge.
- Boat bottom is dirty or damaged.

Battery Will Not Hold Charge

POSSIBLE CAUSES

- Battery connections are loose or corroded.
- Low electrolyte level in battery.
- Worn out or inefficient battery.
- Excessive use of electrical accessories.
- Defective rectifier, alternator, or voltage regulator.

OWNER SERVICE ASSISTANCE

Local Repair Service

Always return your outboard to your local authorized dealer should the need for service arise. Only he has the factory trained mechanics, knowledge, special tools, equipment, and genuine parts and accessories to properly service your engine should the need occur. He knows your engine best.

Service Away from Home

If you are away from your local dealer and the need arises for service, contact the nearest authorized dealer. Refer to the Yellow Pages of the telephone directory. If, for any reason, you cannot obtain service, contact the nearest Mercury Marine Service Office.

Parts and Accessories Inquiries

All inquiries concerning genuine replacement parts and accessories should be directed to your local authorized dealer. The dealer has the necessary information to order parts and accessories for you. When inquiring about parts and accessories, the dealer requires the model and serial number to order the correct parts.

Service Assistance

LOCAL REPAIR SERVICE

If you need service for your Mercury-outboard-powered boat, take it to your authorized dealer. Only authorized dealers specialize in Mercury products and have factory-trained mechanics, special tools and equipment, and genuine Quicksilver parts and accessories to properly service your engine.

NOTE: Quicksilver parts and accessories are engineered and built by Mercury Marine specifically for your power package.

OWNER SERVICE ASSISTANCE

SERVICE AWAY FROM HOME

If you are away from your local dealer and the need arises for service, contact the nearest authorized dealer. If, for any reason, you cannot obtain service, contact the nearest Regional Service Center. Outside the United States and Canada, contact the nearest Marine Power International Service Center.

STOLEN POWER PACKAGE

If your power package is stolen, immediately advise the local authorities and Mercury Marine of the model and serial numbers and to whom the recovery is to be reported. This information is maintained in a database at Mercury Marine to aid authorities and dealers in the recovery of stolen power packages.

ATTENTION REQUIRED AFTER SUBMERSION

1. Before recovery, contact an authorized Mercury dealer.
2. After recovery, immediate service by an authorized Mercury dealer is required to reduce the possibility of serious engine damage.

REPLACEMENT SERVICE PARTS

WARNING

Avoid fire or explosion hazard. Electrical, ignition, and fuel system components on Mercury Marine products comply with federal and international standards to minimize risk of fire or explosion. Do not use replacement electrical or fuel system components that do not comply with these standards. When servicing the electrical and fuel systems, properly install and tighten all components.

Marine engines are expected to operate at or near full throttle for most of their lives. They are also expected to operate in both fresh and saltwater environments. These conditions require numerous special parts.

OWNER SERVICE ASSISTANCE

PARTS AND ACCESSORIES INQUIRIES

Direct any inquiries concerning Quicksilver replacement parts and accessories to your local authorized dealer. The dealer has the necessary information to order parts and accessories for you if they are not in stock. Only authorized dealers can purchase genuine Quicksilver parts and accessories from the factory. Mercury Marine does not sell to unauthorized dealers or retail customers. When inquiring about parts and accessories, the dealer requires the **engine model** and **serial numbers** to order the correct parts.

RESOLVING A PROBLEM

Satisfaction with your Mercury product is important to your dealer and to us. If you ever have a problem, question or concern about your power package, contact your dealer or any authorized Mercury dealership. If you need additional assistance:

1. Talk with the dealership's sales manager or service manager. Contact the owner of the dealership if the sales manager and service manager have been unable to resolve the problem.
2. If your question, concern, or problem cannot be resolved by your dealership, please contact the Mercury Marine Service Office for assistance. Mercury Marine will work with you and your dealership to resolve all problems.

The following information will be needed by the Customer Service:

- Your name and address
- Your daytime telephone number
- The model and serial numbers of your power package
- The name and address of your dealership
- The nature of the problem

CONTACT INFORMATION FOR MERCURY MARINE CUSTOMER SERVICE

For assistance, call, fax, or write to the geographic office in your area. Please include your daytime telephone number with mail and fax correspondence.

OWNER SERVICE ASSISTANCE

United States, Canada		
Telephone	English +1 920 929 5040 Français +1 905 636 4751	Mercury Marine W6250 W. Pioneer Road P.O. Box 1939 Fond du Lac, WI 54936-1939
Fax	English +1 920 929 5893 Français +1 905 636 1704	
Website	www.mercurymarine.com	

Australia, Pacific		
Telephone	+61 3 9791 5822	Brunswick Asia Pacific Group 41-71 Bessemer Drive Dandenong South, Victoria 3175 Australia
Fax	+61 3 9706 7228	

Europe, Middle East, Africa		
Telephone	+32 87 32 32 11	Brunswick Marine Europe Parc Industriel de Petit-Rechain B-4800 Verviers, Belgium
Fax	+32 87 31 19 65	

Mexico, Central America, South America, Caribbean		
Telephone	+1 954 744 3500	Mercury Marine 11650 Interchange Circle North Miramar, FL 33025 U.S.A.
Fax	+1 954 744 3535	

Japan		
Telephone	+81 72 233 8888	Kisaka Co., Ltd. 4-130 Kannabecho, Sakai-ku Sakai-shi, Osaka 590-0984, Japan
Fax	+81 72 233 8833	

Asia, Singapore		
Telephone	+65 65466160	Brunswick Asia Pacific Group T/A Mercury Marine Singapore Pte Ltd 29 Loyang Drive Singapore, 508944
Fax	+65 65467789	

Ordering Literature

Before ordering literature, have the following information about your power package available:

OWNER SERVICE ASSISTANCE

Model		Serial Number	
Horsepower		Year	

UNITED STATES AND CANADA

For additional literature for your Mercury Marine power package, contact your nearest Mercury Marine dealer or contact:

Mercury Marine		
Telephone	Fax	Mail
(920) 929-5110 (USA only)	(920) 929-4894 (USA only)	Mercury Marine Attn: Publications Department P.O. Box 1939 Fond du Lac, WI 54935-1939

OUTSIDE THE UNITED STATES AND CANADA

Contact your nearest Mercury Marine authorized service center to order additional literature that is available for your particular power package.

Submit the following order form with payment to:	Mercury Marine Attn: Publications Department W6250 West Pioneer Road P.O. Box 1939 Fond du Lac, WI 54936-1939
Ship To: (Copy this form and print or type—This is your shipping label)	
Name	
Address	
City, State, Province	
ZIP or postal code	
Country	

Quantity	Item	Stock Number	Price	Total
			.	.
			.	.
			.	.
			.	.
			.	.
Total Due				.

INSTALLATION

Installation Information

BOAT HORSEPOWER CAPACITY

WARNING

Exceeding the boat's maximum horsepower rating can cause serious injury or death. Overpowering the boat can affect boat control and flotation characteristics or break the transom. Do not install an engine that exceeds the boat's maximum power rating.

Do not overpower or overload your boat. Most boats will carry a required capacity plate indicating the maximum acceptable power and load as determined by the manufacturer following certain federal guidelines. If in doubt, contact your dealer or the boat manufacturer.

U.S. COAST GUARD CAPACITY	
MAXIMUM HORSEPOWER	XXX
MAXIMUM PERSON CAPACITY (POUNDS)	XXX
MAXIMUM WEIGHT CAPACITY	XXX

26777

START IN GEAR PROTECTION

WARNING

Starting the engine with the drive in gear can cause serious injury or death. Never operate a boat that does not have a neutral-safety-protection device.

The remote control connected to the outboard must be equipped with a start in neutral only protection device. This prevents the engine from starting in gear.

INSTALLATION

SELECTING ACCESSORIES FOR YOUR OUTBOARD

Genuine Mercury Precision or Quicksilver Accessories have been specifically designed and tested for your outboard. These accessories are available from Mercury Marine dealers.

IMPORTANT: Check with your dealer before installing accessories. The misuse of approved accessories or the use of nonapproved accessories can damage the product.

Some accessories not manufactured or sold by Mercury Marine are not designed to be safely used with your outboard or outboard operating system. Acquire and read the installation, operation and maintenance manuals for all your selected accessories.

LOW PERMEATION FUEL HOSE REQUIREMENT

Required for outboards manufactured for sale, sold, or offered for sale in the United States.

- The Environmental Protection Agency (EPA) requires that any outboard manufactured after January 1, 2009, must use low permeation fuel hose for the primary fuel hose connecting the fuel tank to the outboard.
- Low permeation hose is USCG Type B1-15 or Type A1-15, defined as not exceeding $15/\text{gm}^2/24 \text{ h}$ with CE 10 fuel at $23 \text{ }^\circ\text{C}$ as specified in SAE J 1527 - marine fuel hose.

ELECTRIC FUEL PUMP

If an electric fuel pump is used, the fuel pressure must not exceed 27.58 kPa (4 psi) at the engine. If necessary, install a pressure regulator to regulate the pressure.

Top Cowl Removal and Installation

TOP COWL REMOVAL

1. Unlock the cowl latch located at the rear of the engine by lifting the latch up.

INSTALLATION

2. Lift up on the rear of the cowl and disengage the front hook.

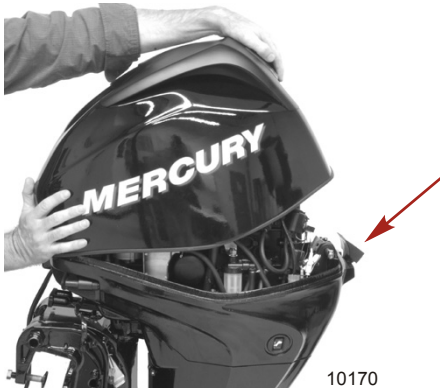

TOP COWL INSTALLATION

1. Engage the front hook and push the top cowl onto the lower cowl.
2. Push the cowl latch down to lock the cowl in place.

Lifting Outboard

Use the lifting eye located aft of the flywheel to support the engine when installing the outboard.

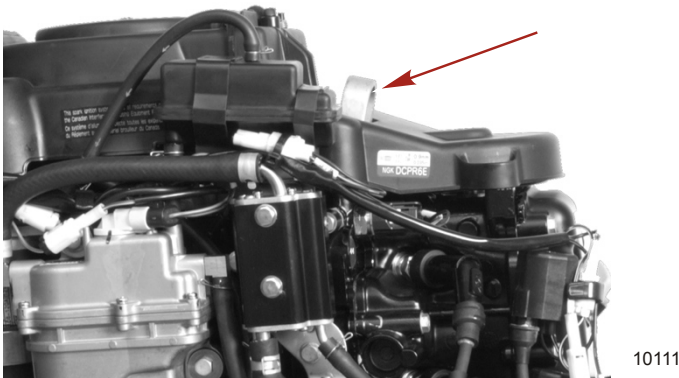

INSTALLATION

Determining the Mounting Height of the Outboard

The following outboard mounting height settings will work good for most applications, however, because of different boat/hull designs, the setting should be checked by test running the boat. Refer to **Water Testing**.

- Installing the outboard too high on the transom will allow the water intake to suck in air and cause cavitation. (Cavitation will cause the engine to overspeed in spurts and reduce thrust.) This condition should be avoided by proper height setting.
- Installing the outboard too low on the transom will allow excessive drag.

BOATS WITH A "V" BOTTOM HULL

1. Measure the width of the leading edge on the water intake housing. Make a horizontal line on the transom up from the "V" bottom the same length as the width of the water intake housing.

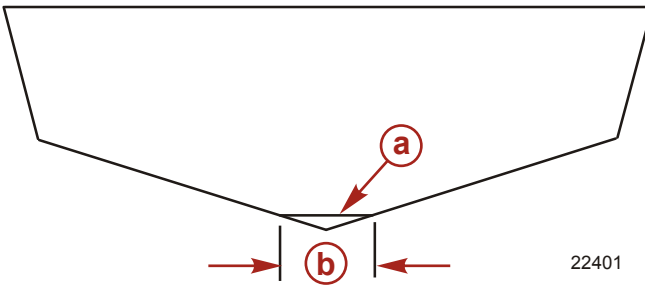

a - Horizontal line

b - Width of the leading edge on the water intake housing

2. Place (center) the outboard on the boat transom. Set the height of the outboard on the boat transom so that the front edge of the water intake housing is in line with the horizontal line made in step 1. Temporarily clamp the outboard to the transom at this position.

INSTALLATION

3. Fasten the outboard to the transom at this height. Refer to **Fastening the Outboard**.

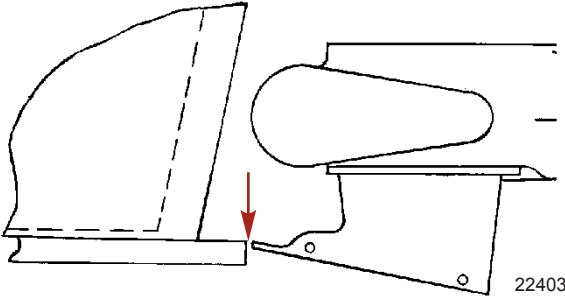

BOATS WITH A FLAT BOTTOM HULL

1. Place (center) the outboard on the boat transom. Set the height of the outboard on the boat transom so that the front edge of the water intake housing is in line with the bottom of the boat as shown. Temporarily clamp the outboard to the transom at this position.
2. Fasten outboard to the transom at this height. Refer to **Fastening the Outboard**.

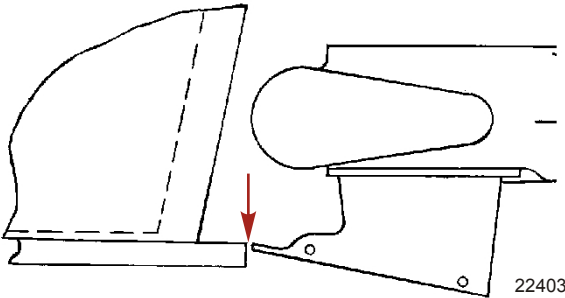

INSTALLATION

Fastening the Outboard

WARNING

Failure to correctly fasten the outboard could result in the outboard propelling off the boat transom resulting in property damage, serious injury, or death. Before operation, the outboard must be correctly installed with the required mounting hardware.

This product must be secured to the transom with the required mounting hardware. If the outboard strikes an under water object, the required mounting hardware prevents the outboard from propelling off the transom. A decal on the swivel bracket reminds the installer of the potential hazard.



52375

INSTALLATION

IMPORTANT: Determine the strength of the boat transom. The outboard mounting locknuts and bolts should be able to hold 75 Nm (55 lb. ft.) of torque without the boat transom yielding or cracking. If the boat transom yields or cracks under this torque, the construction of the transom may not be adequate. The boat transom must be strengthened or the load carrying area increased.

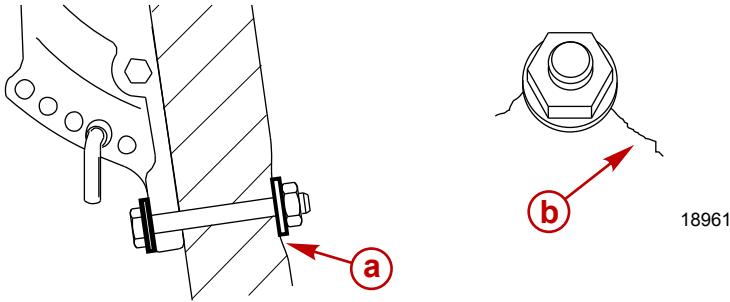

- a** - Transom yielding under bolt torque
- b** - Transom cracking under bolt torque

When first determining transom strength, use a dial torque wrench. If the bolt or nut continues to turn without the torque reading on the dial increasing, it is an indication that the transom is yielding. The load area can be increased by using a larger washer or a transom reinforcement plate.

INSTALLATION

NOTE: The inside holes on the transom reinforcement plate are for the lower transom bolts and the outside holes are for the upper transom bolts.

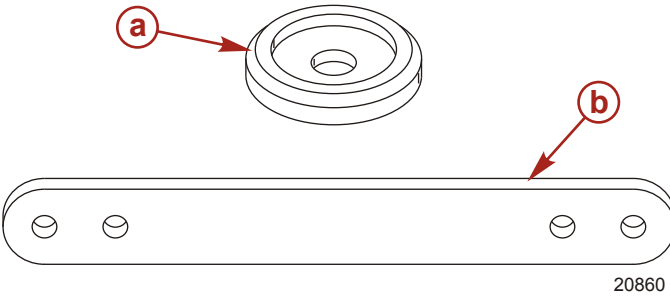

- a** - Large transom washer
- b** - Transom reinforcement plate

1. Drill four 13.5 mm (17/32 in.) mounting holes.
2. Install the outboard so that the water intake housing is set at the correct height. Refer to **Determining Outboard Mounting Height**.
3. Apply marine sealer to shanks of bolts. Do not apply marine sealer to the threads of the bolts.
4. Fasten the outboard with provided mounting hardware shown. Tighten the locknuts to the specified torque.

The outboard must be secured to the transom with the two transom bracket clamp screws and four 13 mm (1/2 in.) diameter mounting bolts and locknuts provided. Install two bolts through the upper set of mounting holes and two bolts through the lower set of mounting slots.

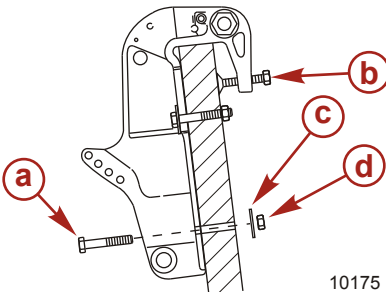

- a** - Bolt (4)
- b** - Transom bracket clamp screws
- c** - Washer (4)
- d** - Locknut (4)

10175

INSTALLATION

Description	Nm	lb. in.	lb. ft.
Outboard mounting locknuts and bolts	75		55

Steering Bracket, Steering Cable Installation

1. Lubricate entire cable end with 2-4-C with PTFE.

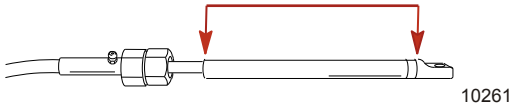

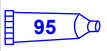
Tube Ref No.	Description	Where Used	Part No.
 95	2-4-C with PTFE	Steering cable end	92-802859A 1

2. Install the cable seal onto the tilt tube.
3. Install the steering bracket with two washers and two 30 x 80 mm bolts. Tighten the steering bracket bolts to the specified torque.
4. Install the steering cable and tighten the steering cable nut to the specified torque.

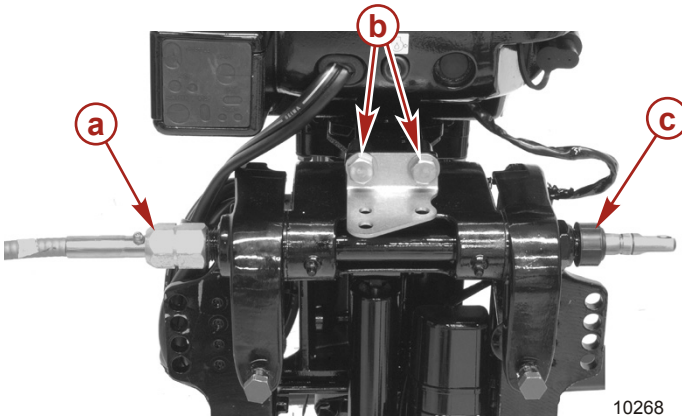

- a** - Steering cable nut
- b** - Steering bracket bolt and washer (2)
- c** - Cable seal

INSTALLATION

Description	Nm	lb. in.	lb. ft.
Steering cable nut	47.5		35
Steering bracket bolt	30		22.13

Steering Link Rod Fasteners

IMPORTANT: The steering link rod that connects the steering cable to the engine must be fastened using the steering link rod fastening hardware supplied with engine. Never replace the locknuts (11-16147--3) with common nuts (non-locking) as they will work loose and vibrate off, freeing the link rod to disengage.

WARNING

Improper fasteners or improper installation procedures can result in loosening or disengagement of the steering link rod. This can cause a sudden, unexpected loss of boat control, resulting in serious injury or death due to occupants being thrown within or out of the boat. Always use required components and follow instructions and torque procedures.

Assemble steering link rod to steering cable with flat washer and nylon insert locknut. Tighten locknut until it seats, then back nut off 1/4 turn.

INSTALLATION

Assemble steering link rod to engine with bolt, locknut, spacer, and flat washers. Tighten the locknut to the specified torque.

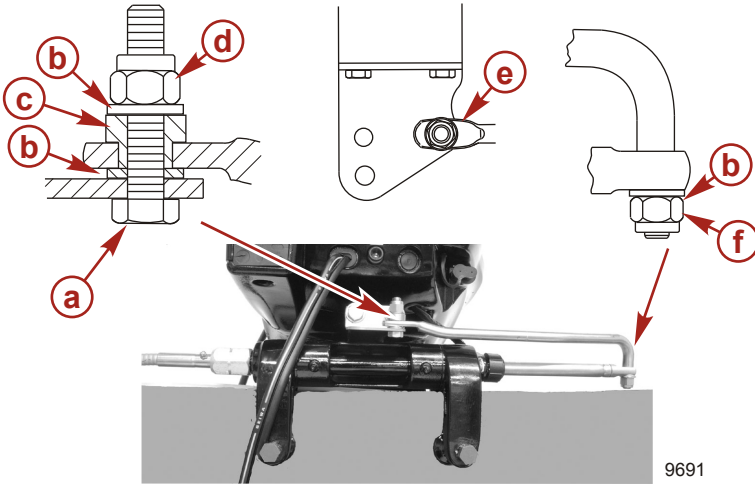

- a** - Bolt (10-898101018)
- b** - Flat washer (12-95392-10)
- c** - Spacer (23-853826001)
- d** - Nylon insert locknut (11-16147--3)
- e** - Install steering link rod into side hole
- f** - Nylon insert locknut (11-16147--3) (tighten until it seats, then back off 1/4 turn)

Description	Nm	lb-in.	lb-ft
Nylon insert locknut "d"	27	–	20
Nylon insert locknut "f"	Tighten until it seats, then back off ¼ turn		

INSTALLATION

Electrical Harness, Battery Connection, Fuel Tanks

REMOTE WIRING HARNESS

1. Remove the three access cover bolts. Remove the access cover and cable rubber grommet.

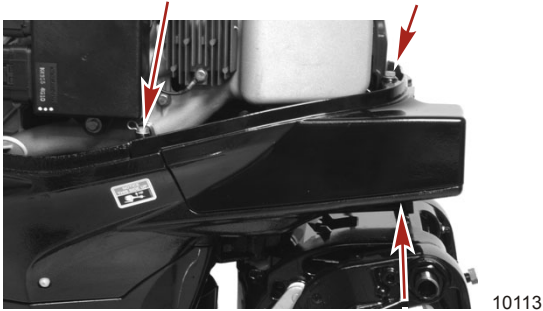

2. Remove the cable barrel retainer.

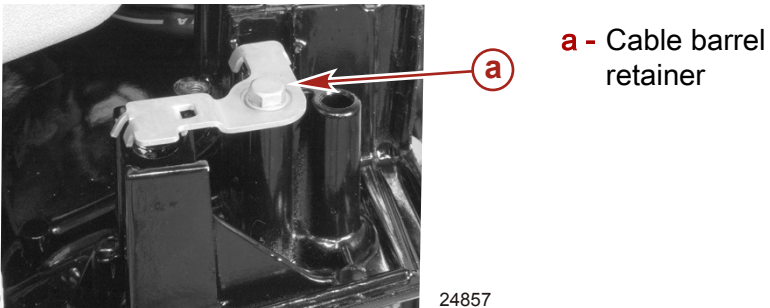

INSTALLATION

3. Loosen the harness retainer. Route the remote harness into the cowl as shown and below the harness retainer.

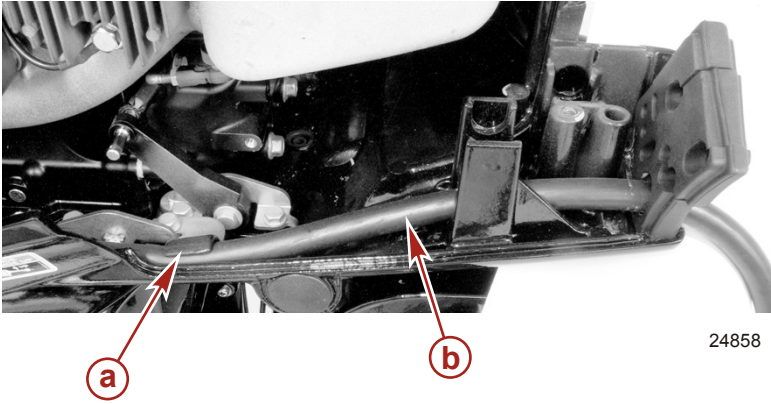

- a** - Harness retainer
- b** - Remote harness

4. Connect the remote harness to the engine harness connector.

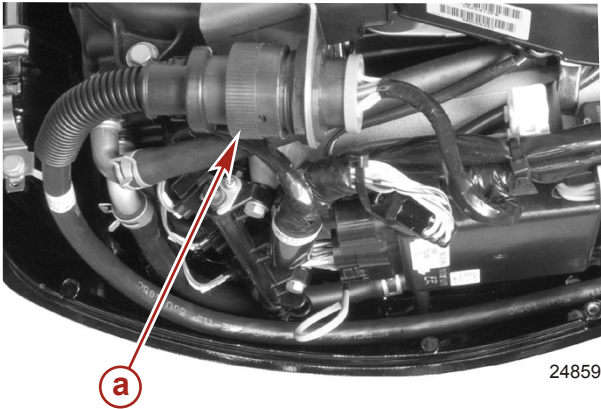

- a** - Harness connector

5. Fasten the remote harness to the cowl with the harness retainer. Tighten the bolt to the specified torque.

INSTALLATION

Description	Nm	lb. in.	lb. ft.
Harness retainer bolt	6	53	

BATTERY CABLE CONNECTIONS

IMPORTANT: To prevent damage to the engine charging system when the battery cables are not connected to a battery, ensure the battery cable ends are thoroughly insulated.

Single Outboard

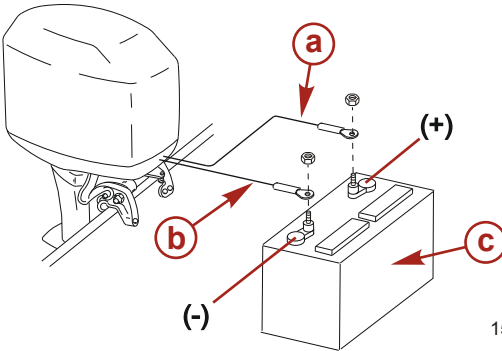

- a** - Red sleeve - positive (+)
- b** - Black sleeve - negative (-)
- c** - Cranking battery

15496

INSTALLATION

Dual Outboards

Connect a common ground cable (wire size same as engine battery cables) between negative (-) terminals on starting batteries.

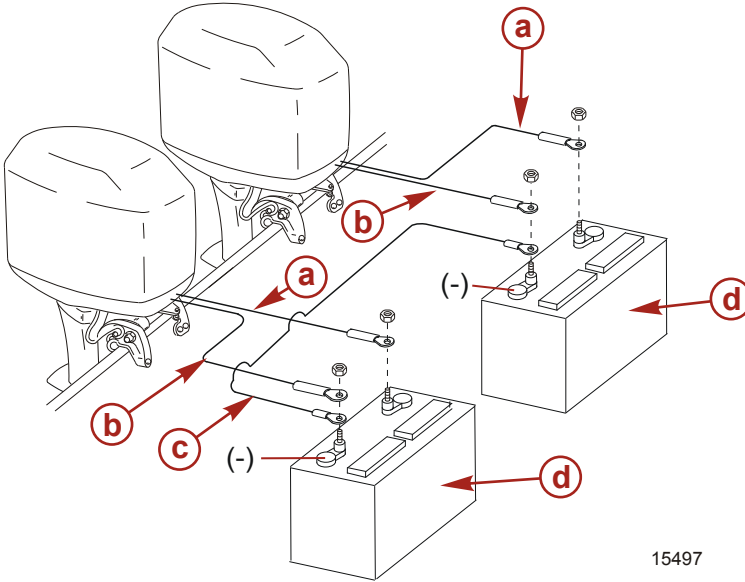

15497

- a** - Red sleeve - positive (+)
- b** - Black sleeve - negative (-)
- c** - Ground cable
- d** - Cranking battery

FUEL TANKS

Portable Fuel Tank

Select a suitable location in the boat within the engine fuel line length limitations and secure the tank in place.

Permanent Fuel Tank

Permanent fuel tanks should be installed in accordance with industry and federal safety standards, which include recommendations applicable to grounding, anti-siphon protection, ventilation, etc.

INSTALLATION

Control Cable Installation

THROTTLE CABLE INSTALLATION

Install the cables into the remote control following the instructions provided with the remote control.

1. Move the remote control handle from neutral into forward and advance the handle to full speed position.

NOTE: *The throttle cable is the second cable to move when moving the control box out of neutral.*

2. Install the throttle cable to the throttle actuating lever. Secure with a washer and cotter pin retainer.
3. Adjust the throttle cable barrel, so when barrel is installed into the throttle cable barrel support, no play can be felt when lightly pushing the throttle cam with your finger.

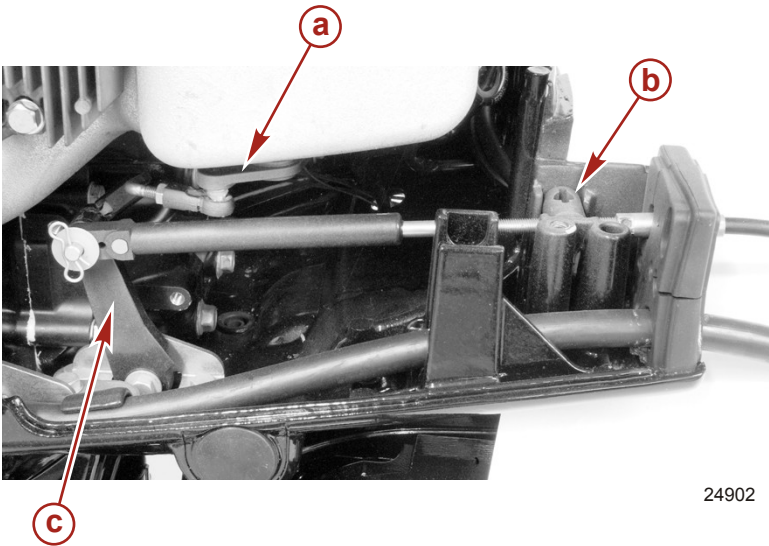

24902

- a** - Throttle cam (no play can be felt when lightly pushing)
 - b** - Throttle cable barrel
 - c** - Throttle actuating lever
4. Slowly return the remote control handle back to the neutral detent position.
 5. Inspect the cam roller to ensure it is not contacting the cam.

INSTALLATION

- Adjust the throttle cable barrel if the cam roller is touching the cam.

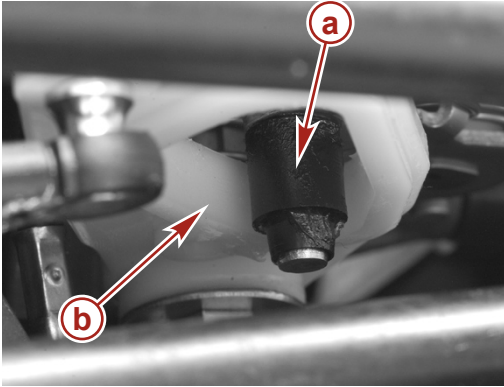

15952

- a** - Cam roller
- b** - Throttle cam

- Install the cable grommet.
- Secure the throttle cable barrel with the cable barrel retainer.

INSTALLATION

9. Tighten the cable barrel retainer bolt to the specified torque.

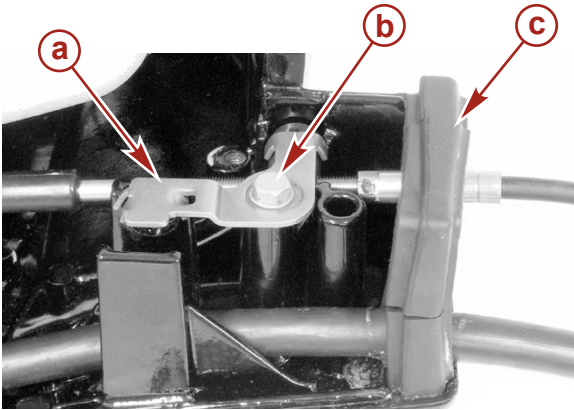

24903

- a** - Cable barrel retainer
- b** - Cable barrel retainer bolt
- c** - Cable grommet

Description	Nm	lb. in.	lb. ft.
Cable barrel retainer bolt	6	53	

10. Install the access cover and secure with three bolts. Tighten bolts to the specified torque.

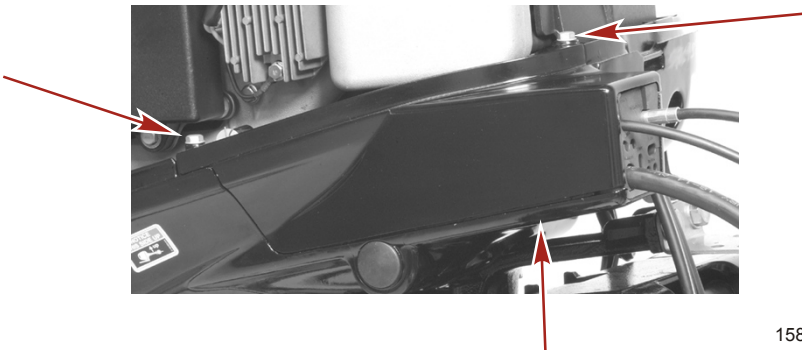

15858

Description	Nm	lb. in.	lb. ft.
Access cover bolt (3)	10	88	

INSTALLATION

SHIFT CABLE INSTALLATION

WARNING

If not properly installed, the reverse gate can interfere with water coming off the rudder, suddenly and unexpectedly slowing the boat. This can cause serious injury or death from occupants being thrown within or out of the boat. Adjust the shift cable to prevent the reverse gate from interfering with water flow off the rudder.

1. Attach the shift cable to the shift cam with a flat washer and a self-locking nylon insert locknut as shown. Tighten the locknut against the flatwasher, then back-off the locknut 1/4 turn.
2. Place the remote control handle into full forward position.
3. Adjust the shift cable adjustment barrel so that the roller is at the full end of travel (bottom) in the shift cam.

INSTALLATION

4. Attach the shift cable adjustment barrel to the bracket with a bolt and locknut. Tighten the bolt until it seats against the adjustment barrel, then back-off the bolt 1/4 turn. Hold the bolt from turning, and tighten the locknut on the bolt. The adjustment barrel must be free to pivot.

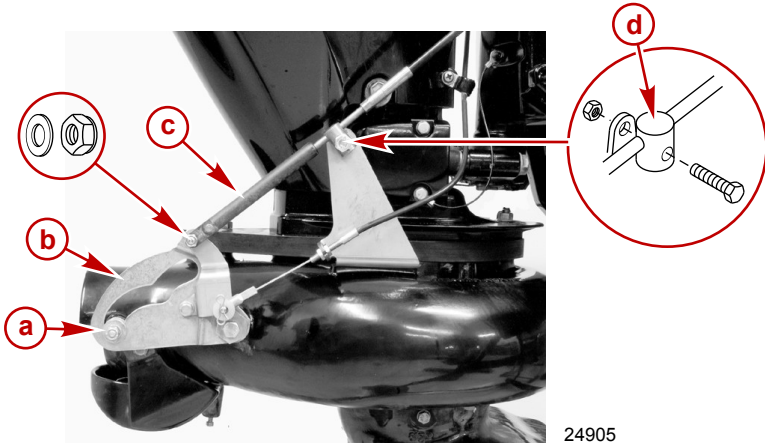

- a** - Roller
- b** - Shift cam
- c** - Shift cable
- d** - Shift cable adjustment barrel

5. Check the shift cable adjustment in forward shift position. The correct shift adjustment will position the cam far enough on the roller to lock the reverse gate into forward position. Push on the reverse gate by hand to verify it is locked into position. The reverse gate should not move when pushed toward the neutral position.

IMPORTANT: The forward locking of the reverse gate must be met. If not, readjust the shift cable.

INSTALLATION

Water Testing

CHECKING FOR CAVITATION

The initial outboard height setting should be close to the optimum setting for the outboard. However, because of the hull design of some boats, obstructions, or imperfections in the hull ahead of the water intake, adjustments may be required to prevent cavitation at running speeds.

When operating the boat, the outboard driveshaft housing should be vertical, or tilted toward the boat, when planing to provide a scooping angle on the water intake. Tilting the outboard out beyond a vertical position reduces the scoop angle and can cause impeller slippage and cavitation.

IMPORTANT: If the angle of the boat transom does not allow the driveshaft housing to be positioned vertical, a wedge kit should be installed behind the transom brackets to increase the tilt-in angle.

NOTE: Slight cavitation in sharp turns and rough water is acceptable, but excessive cavitation is harmful to the outboard and should be avoided.

Test run the boat. If cavitation occurs (air enters the pump), the first thing to try is lowering the outboard mounting height.

If cavitation still exists after lowering the outboard, it may be helpful to seek advice from the boat manufacturer.

Another option to further reduce cavitation is a rough water plate.

INSTALLATION

A rough water plate may be helpful in reducing cavitation when running in windy, rough water conditions where air is sucked into the water intake when jumping waves. Install a 0.8 mm (1/32 in.) metal plate that extends from the hull bottom to the top of the water intake housing. This plate tends to reduce air intake as well as reduce spray.

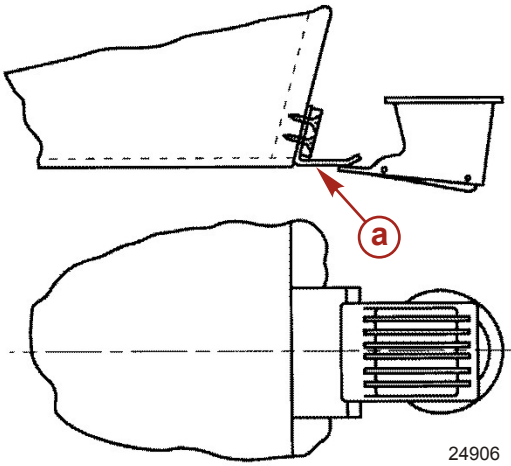

a - Rough water plate

MAINTENANCE LOG

Maintenance Log

Record all maintenance performed on your outboard here. Be sure to save all work orders and receipts.

Date	Maintenance Performed	Engine Hours