

Declaration of Conformity - For Recreational Craft Propulsion Engines with the Requirements of Directive 94/25/EC as amended by 2003/44/EC

90-8M0079565 313

Name of engine manufacturer: Tohatsu Marine Corporation (TMC) Mercury Marine Joint Venture		
Address: Shimodaira 4495-9		
Town: Komagane-City, Nagano	Post Code: 399-4101	Country: Japan

Name of Authorized Representative: Brunswick Marine in EMEA Inc.		
Address: Parc Industriel de Petit-Rechain		
Town: Verviers	Post Code: B-B-2800	Country: Belgium

Name of Notified Body for exhaust emission assessment: TÜV SÜD Group			
Address: Ridlerstrasse 65			
Town: Munich	Post Code: 80339	Country: Germany	ID Number: 0123

Name of Notified Body for noise emission assessment: International Marine Certification Institute			
Address: Rue Abbé Cuypers 3			
Town: Bruxelles	Post Code: B-1040	Country: Belgium	ID Number: 0609

Conformity assessment module used for exhaust emissions:	<input checked="" type="checkbox"/> B +C	<input type="checkbox"/> B +D	<input type="checkbox"/> B +E	<input type="checkbox"/> B +F	<input type="checkbox"/> G	<input type="checkbox"/> H
Conformity assessment module used for noise emissions:	<input type="checkbox"/> A	<input checked="" type="checkbox"/> Aa	<input type="checkbox"/> G	<input type="checkbox"/> H		
Other Community Directives applied: Safety of Machinery Directive 2006/42/EC; Electromagnetic Compatibility Directive 2004/108/EC						

Description of Engines and Essential Requirements

Engine Type	Fuel Type	Combustion Cycle
<input checked="" type="checkbox"/> Outboard engine	<input checked="" type="checkbox"/> Petrol	<input checked="" type="checkbox"/> 4 stroke

15/20 FourStroke

© 2013 Mercury Marine

Identification of Engines Covered by This Declaration of Conformity

Name of engine model or engine family	Starting serial number	EC Type—examination certificate or type—approval certificate number
2.5, 3.5 hp	0R098000	SB5 09 01 57840 033
4, 5, 6 hp	0R098000	SB5 11 04 57840 037
15, 20 hp	0R235168	SB5 07 12 57840 027
25, 30 hp EFI	0R098000	SB5 05 10 57840 003

Essential requirements	Standards	Other normative document/method	Technical file	Please specify in more detail (* = mandatory standard)
Annex 1.B—Exhaust Emissions				
B.1 engine identification	<input type="checkbox"/>	<input type="checkbox"/>	<input checked="" type="checkbox"/>	
B.2 exhaust emission requirements	<input checked="" type="checkbox"/> *	<input type="checkbox"/>	<input type="checkbox"/>	* EN ISO 8178-1:1996
B.3 durability	<input type="checkbox"/>	<input type="checkbox"/>	<input checked="" type="checkbox"/>	
B.4 owner's manual	<input checked="" type="checkbox"/>	<input type="checkbox"/>	<input type="checkbox"/>	ISO 8665: 2006
Annex 1.C—Noise Emissions				
C.1 Noise emission levels	<input checked="" type="checkbox"/> *	<input type="checkbox"/>	<input type="checkbox"/>	EN ISO 14509
C.2 Owner's manual	<input type="checkbox"/>	<input checked="" type="checkbox"/>	<input type="checkbox"/>	Owner's manual

This declaration of conformity is issued under the sole responsibility of the manufacturer. I declare on behalf of the engine manufacturer that the engines mentioned preceding complies with all applicable essential requirements in the way specified.

Name / function:

Mark D. Schwabero, President,
Mercury Marine

**Date and place of issue:**

September 04, 2012
Fond du Lac, Wisconsin, USA

Welcome

You have selected one of the finest outboards available. It incorporates numerous design features to ensure operating ease and durability.

With proper care and maintenance, you will enjoy using this product for many boating seasons. To ensure maximum performance and carefree use, we ask that you thoroughly read this manual.

The Operation, Maintenance and Warranty Manual contains specific instructions for using and maintaining your product. We suggest that this manual remain with the product for ready reference whenever you are on the water.

Thank you for purchasing one of our products. We sincerely hope your boating will be pleasant!

Mercury Marine

EPA Emissions Regulations

Outboards sold by Mercury Marine in the United States are certified to the United States Environmental Protection Agency as conforming to the requirements of the regulations for the control of air pollution from new outboard motors. This certification is contingent on certain adjustments being set to factory standards. For this reason, the factory procedure for servicing the product must be strictly followed and, wherever practicable, returned to the original intent of the design.

Maintenance, replacement, or repair of the emission control devices and systems may be performed by any marine engine repair establishment or individual.

Engines are labeled with an emission control information decal as permanent evidence of EPA certification.

 **WARNING**

The engine exhaust from this product contains chemicals known to the state of California to cause cancer, birth defects or other reproductive harm.

Warranty Message

The product you have purchased comes with a limited warranty from Mercury Marine. The terms of the warranty are set forth in the **Warranty Information** section of this manual. The warranty statement contains a description of what is covered, what is not covered, the duration of coverage, how to best obtain warranty coverage, important disclaimers and limitations of damages, and other related information. Please review this information.

The description and specifications contained herein were in effect at the time this manual was approved for printing. Mercury Marine, whose policy is one of continued improvement, reserves the right to discontinue models at any time, and to change specifications, designs, methods, or procedures without notice and without incurring obligation.

Mercury Marine, Fond du Lac, Wisconsin U.S.A.

Printed in the U.S.A.

© 2013, Mercury Marine

Alpha, Axius, Bravo One, Bravo Two, Bravo Three, Circle M with Waves Logo, K-planes, Mariner, MerCathode, MerCruiser, Mercury, Mercury with Waves Logo, Mercury Marine, Mercury Precision Parts, Mercury Propellers, Mercury Racing, MotorGuide, OptiMax, Quicksilver, SeaCore, Skyhook, SmartCraft, Sport-Jet, Verado, VesselView, Zero Effort, Zeus, and #1 On the Water are registered trademarks of Brunswick Corporation. Mercury Product Protection is a registered service mark of Brunswick Corporation.

Mercury Premier Service

Mercury evaluates the service performance of its dealers and assigns its highest rating of "Mercury Premier" to those demonstrating an exceptional commitment to service.

Earning a Mercury Premier Service rating means a dealer:

- Achieves a high 12-month service Customer Satisfaction Index (CSI) score for warranty service.
- Possesses all of the necessary service tools, test equipment, manuals, and parts books.
- Employs at least one certified or master technician.
- Provides timely service for all Mercury Marine customers.
- Offers extended service hours and mobile service, when appropriate.
- Uses, displays, and stocks an adequate inventory of genuine Mercury Precision Parts.
- Offers a clean, neat shop with well-organized tools and service literature.

WARRANTY INFORMATION

Warranty Registration United States and Canada.....	1
Transfer of Warranty United States and Canada.....	1
Transfer of Mercury Product Protection (Extended Service Coverage) Plan United States and Canada.....	2
FourStroke Outboard Limited Warranty United States and Canada.....	3
3 Year Limited Warranty Against Corrosion.....	6
Warranty Coverage and Exclusions.....	10
U.S. EPA Emissions Limited Warranty.....	12
Emission Control System Components.....	12
California Emissions Limited Warranty.....	13
California Air Resources Board Explanation of Your California Emission Control Warranty Statement.....	17
Emission Certification Star Label.....	18
Warranty Policies Outside The United States and Canada.....	19

General Information

Boater's Responsibilities.....	33
Before Operating Your Outboard.....	33
Boat Horsepower Capacity.....	34
High-Speed and High-Performance Boat Operation.....	34
Outboard Remote Control Models	35
Remote Steering Notice.....	35
Lanyard Stop Switch.....	36
Protecting People in the Water.....	40
Passenger Safety Message - Pontoon Boats and Deck Boats	41
Wave and Wake Jumping.....	42
Impact with Underwater Hazards.....	43
Exhaust Emissions.....	45
Selecting Accessories for Your Outboard.....	48
Safe Boating Recommendations.....	48
Recording Serial Number	51
Specifications.....	52

Transporting

Carrying, Storing, and Transporting Your Outboard when Removed from Boat	53
Transporting Portable Fuel Tanks.....	54
Trailing Boat/Outboard	54

Fuel and Oil

Fuel Recommendations.....	56
Low Permeation Fuel Hose Requirement	57
EPA Pressurized Portable Fuel Tank Requirements.....	58
Fuel Demand Valve (FDV) Requirement.....	58
Mercury Marine's Pressurized Portable Fuel Tank.....	59
Filling Fuel Tank.....	60
Engine Oil Recommendations.....	61
Checking Engine Oil.....	61

Features and Controls

Tiller Handle Features.....	64
Remote Control Features.....	68
General Features.....	68
Manual Tilt Features and Operation.....	70
Power Tilt Features and Operation.....	75
Warning System Features and Operation.....	80
Trim Tab Adjustment.....	82

Operation

Prestarting Check List.....	83
Operating in Freezing Temperatures.....	83
Operating in Saltwater or Polluted Water.....	84
Operating Outboard as an Auxiliary Engine.....	84
Pre-Starting Instructions.....	84
Engine Break-in Procedure.....	86
Starting the Engine - Tiller Handle Models.....	86
Starting the Engine - Remote Control Models.....	90
Gear Shifting	94
Stopping the Engine	95
Emergency Starting.....	96

Maintenance

Outboard Care.....	98
EPA Emission Regulations.....	98
Inspection and Maintenance Schedule.....	99
Flushing the Cooling System.....	101
Top Cowl Removal and Installation.....	103
Battery Inspection	104
Exterior Care.....	104
Fuel System.....	105
Steering Link Rod Fasteners.....	106
Corrosion Control Anode	108
Propeller Replacement	109
Fuse Replacement - Electric Start Models	113
Spark Plug Inspection and Replacement.....	114
Timing Belt Inspection.....	115
Changing Engine Oil	115
Lubrication Points	118
Gearcase Lubrication.....	121
Checking Power Tilt Fluid.....	123
Submerged Outboard.....	124

Storage

Storage Preparation.....	125
Protecting External Outboard Components.....	126
Protecting Internal Engine Components.....	126
Gearcase.....	126
Positioning Outboard for Storage.....	127
Battery Storage.....	127

Troubleshooting

Starter Motor Will Not Crank the Engine (Electric Start Models)	129
Engine Will Not Start.....	129
Engine Runs Erratically.....	129
Performance Loss.....	130
Battery Will Not Hold Charge.....	130

Owner Service Assistance

Local Repair Service.....	131
Service Away from Home.....	131
Parts and Accessories Inquiries.....	131
Service Assistance.....	131
Ordering Literature.....	134

Engine Installation

Boat Horsepower Capacity.....	136
Start in Gear Protection.....	136
Selecting Accessories for Your Outboard.....	137
Low Permeation Fuel Hose Requirement	137
Lifting the Outboard.....	137
Installing Outboard.....	138
Steering Cable Installation.....	140
Steering Link Rod Fasteners.....	141
Remote Wiring Harness and Control Cable Installation.....	143
Battery Installation - Electric Start Models.....	149
Battery Connections.....	149

Maintenance Log

Maintenance Log.....	151
----------------------	-----

WARRANTY INFORMATION

Warranty Registration United States and Canada

To be eligible for warranty coverage, the product must be registered with Mercury Marine.

At the time of sale, the selling dealer should complete the warranty registration and immediately submit it to Mercury Marine via MercNET, e-mail, or mail. Upon receipt of this warranty registration, Mercury Marine will record the registration.

A copy of the warranty registration should be provided to you by your selling dealer.

NOTE: Registration lists must be maintained by Mercury Marine and any dealer of Mercury Marine products sold in the United States, should a safety recall notification under the Federal Safety Act be required.

You may change your registered address at any time, including at time of warranty claim, by calling Mercury Marine or sending a letter or fax with your name, old address, new address, and engine serial number to Mercury Marine's warranty registration department. Your dealer can also process this change of information.

Mercury Marine

Attn: Warranty Registration Department

W6250 W. Pioneer Road

P.O. Box 1939

Fond du Lac, WI 54936-1939

920-929-5054

Fax +1 920 907 6663

OUTSIDE UNITED STATES AND CANADA

For products purchased outside the United States and Canada, contact the distributor in your country, or the Marine Power Service Center closest to you.

Transfer of Warranty United States and Canada

The limited warranty is transferable to a subsequent purchaser, but only for the remainder of the unused portion of the limited warranty. This will not apply to products used for commercial applications.

WARRANTY INFORMATION

To transfer the warranty to the subsequent owner, send or fax a copy of the bill of sale or purchase agreement, new owner's name, address, and engine serial number to Mercury Marine's warranty registration department. In the United States and Canada, mail to:

Mercury Marine
Attn: Warranty Registration Department
W6250 W. Pioneer Road
P.O. Box 1939
Fond du Lac, WI 54936-1939
920-929-5054
Fax +1 920 907 6663

Upon processing the transfer of warranty, Mercury Marine will record the new owner's information.

There is no charge for this service.

OUTSIDE THE UNITED STATES AND CANADA

For products purchased outside the United States and Canada, contact the distributor in your country, or the Marine Power Service Center closest to you.

Transfer of Mercury Product Protection (Extended Service Coverage) Plan United States and Canada

The remaining coverage period of the Product Protection Plan is transferable to the subsequent purchaser of the engine within thirty (30) days from the date of sale. Contracts not transferred within thirty (30) days of the subsequent purchase will no longer be valid and the product will no longer be eligible for coverage under the terms of the contract.

To transfer the plan to the subsequent owner, contact Mercury Product Protection or an authorized dealer to receive a Request for Transfer form. Submit to Mercury Product Protection a receipt/bill of sale, a completed Request of Transfer form, and a check payable to Mercury Marine in the amount of \$50.00 (per engine) to cover the transfer fee.

Plan coverage is not transferable from one product to another product or for noneligible applications.

The certified preowned engine plans are not transferable.

WARRANTY INFORMATION

For help or assistance, contact Mercury Product Protection Department at 1-888-427-5373 from 7:30 a.m. to 4:30 p.m. CST, Monday–Friday or e-mail mpp_support@mercmarine.com.

FourStroke Outboard Limited Warranty United States and Canada

Outside the United States and Canada - Check with your local distributor.

WHAT IS COVERED: Mercury Marine warrants its new products to be free of defects in material and workmanship during the period described below.

DURATION OF COVERAGE: This Limited Warranty provides coverage for three (3) years from the date the product is first sold to a recreational use retail purchaser, or the date on which the product is first put into service, whichever occurs first.

Commercial users of these products receive warranty coverage of one (1) year from the date of first retail sale, or one (1) year from the date on which the product was first put into service, whichever occurs first. Commercial use is defined as any work or employment related use of the product, or any use of the product which generates income, for any part of the warranty period, even if the product is only occasionally used for such purposes.

The repair or replacement of parts, or the performance of service under this warranty, does not extend the life of this warranty beyond its original expiration date. Unexpired warranty coverage can be transferred from one recreational use customer to a subsequent recreational use customer upon proper reregistration of the product. Unexpired warranty coverage cannot be transferred either to or from a commercial use customer.

Warranty coverage may be terminated for used repossessed product; or product purchased at auction, from a salvage yard, or from an insurance company.

WARRANTY INFORMATION

CONDITIONS THAT MUST BE MET IN ORDER TO OBTAIN WARRANTY COVERAGE: Warranty coverage is available only to retail customers that purchase from a Dealer authorized by Mercury Marine to distribute the product in the country in which the sale occurred, and then only after the Mercury Marine specified predelivery inspection process is completed and documented. Warranty coverage becomes available upon proper registration of the product by the authorized dealer. Inaccurate warranty registration information regarding recreational use, or subsequent change of use from recreational to commercial (unless properly reregistered) may void the warranty at the sole discretion of Mercury Marine. Routine maintenance outlined in the Operation and Maintenance Manual must be timely performed in order to maintain warranty coverage. Mercury Marine reserves the right to make warranty coverage contingent upon proof of proper maintenance.

WHAT MERCURY WILL DO: Mercury's sole and exclusive obligation under this warranty is limited to, at our option, repairing a defective part, replacing such part or parts with new or Mercury Marine certified remanufactured parts, or refunding the purchase price of the Mercury product. Mercury reserves the right to improve or modify products from time to time without assuming an obligation to modify products previously manufactured.

WARRANTY INFORMATION

HOW TO OBTAIN WARRANTY COVERAGE: The customer must provide Mercury with a reasonable opportunity to repair, and reasonable access to the product for warranty service. Warranty claims shall be made by delivering the product for inspection to a Mercury dealer authorized to service the product. If purchaser cannot deliver the product to such a dealer, written notice must be given to Mercury. We will then arrange for the inspection and any covered repair. Purchaser, in that case, shall pay for all related transportation charges and/or travel time. If the service provided is not covered by this warranty, purchaser shall pay for all related labor and material, and any other expenses associated with that service. Purchaser shall not, unless requested by Mercury, ship the product or parts of the product directly to Mercury. Proof of registered ownership must be presented to the dealer at the time warranty service is requested in order to obtain coverage.

WHAT IS NOT COVERED: This limited warranty does not cover routine maintenance items, tune-ups, adjustments, normal wear and tear, damage caused by abuse, abnormal use, use of a propeller or gear ratio that does not allow the engine to run in its recommended wide-open throttle RPM range (see the Operation and Maintenance Manual), operation of the product in a manner inconsistent with the recommended operation/duty cycle section of the Operation and Maintenance Manual, neglect, accident, submersion, improper installation (proper installation specifications and techniques are set forth in the installation instructions for the product), improper service, use of an accessory or part not manufactured or sold by us, jet pump impellers and liners, operation with fuels, oils, or lubricants which are not suitable for use with the product (see the Operation and Maintenance Manual), alteration or removal of parts, water entering the engine through the fuel intake, air intake or exhaust system, or damage to the product from insufficient cooling water caused by blockage of the cooling system by a foreign body, running the engine out of water, mounting the engine too high on the transom, or running the boat with the engine trimmed out too far. Use of the product for racing or other competitive activity, or operating with a racing type lower unit, at any point, even by a prior owner of the product, voids the warranty.

WARRANTY INFORMATION

Expenses related to haul-out, launch, towing, storage, telephone, rental, inconvenience, slip fees, insurance coverage, loan payments, loss of time, loss of income, or any other type of incidental or consequential damages are not covered by this warranty. Also, expenses associated with the removal and/or replacement of boat partitions or material caused by boat design for access to the product are not covered by this warranty.

No individual or entity, including Mercury Marine authorized dealers, has been given authority by Mercury Marine to make any affirmation, representation, or warranty regarding the product, other than those contained in this limited warranty, and if made, shall not be enforceable against Mercury Marine.

For additional information regarding events and circumstances covered by this warranty, and those that are not, see the Warranty Coverage section of the Operation and Maintenance Manual, incorporated by reference into this warranty.

DISCLAIMERS AND LIMITATIONS:

THE IMPLIED WARRANTIES OF MERCHANTABILITY AND FITNESS FOR A PARTICULAR PURPOSE ARE EXPRESSLY DISCLAIMED. TO THE EXTENT THAT THEY CANNOT BE DISCLAIMED, THE IMPLIED WARRANTIES ARE LIMITED IN DURATION TO THE LIFE OF THE EXPRESS WARRANTY. INCIDENTAL AND CONSEQUENTIAL DAMAGES ARE EXCLUDED FROM COVERAGE UNDER THIS WARRANTY. SOME STATES/COUNTRIES DO NOT ALLOW FOR THE DISCLAIMERS, LIMITATIONS AND EXCLUSIONS IDENTIFIED ABOVE, AS A RESULT, THEY MAY NOT APPLY TO YOU. THIS WARRANTY GIVES YOU SPECIFIC LEGAL RIGHTS, AND YOU MAY ALSO HAVE OTHER LEGAL RIGHTS WHICH VARY FROM STATE TO STATE AND COUNTRY TO COUNTRY.

3 Year Limited Warranty Against Corrosion

WHAT IS COVERED: Mercury Marine warrants that each new Mercury, Mariner, Mercury Racing, Sport-Jet, M² Jet Drive, Tracker by Mercury Marine Outboard, Mercury MerCruiser Inboard or Sterndrive Engine (Product) will not be rendered inoperative as a direct result of corrosion for the period of time described below.

WARRANTY INFORMATION

DURATION OF COVERAGE: This limited corrosion warranty provides coverage for three (3) years from either the date the product is first sold, or the date on which the product is first put into service, whichever occurs first. The repair or replacement of parts, or the performance of service under this warranty, does not extend the life of this warranty beyond its original expiration date. Unexpired warranty coverage can be transferred to subsequent (noncommercial use) purchaser upon proper reregistration of the product.

CONDITIONS THAT MUST BE MET IN ORDER TO OBTAIN WARRANTY COVERAGE: Warranty coverage is available only to retail customers that purchase from a Dealer authorized by Mercury Marine to distribute the product in the country in which the sale occurred, and then only after the Mercury Marine specified predelivery inspection process is completed and documented. Warranty coverage becomes available upon proper registration of the product by the authorized dealer. Corrosion prevention devices specified in the Operation and Maintenance Manual must be in use on the boat, and routine maintenance outlined in the Operation and Maintenance Manual must be timely performed (including, without limitation, the replacement of sacrificial anodes, use of specified lubricants, and touch-up of nicks and scratches) in order to maintain warranty coverage. Mercury Marine reserves the right to make warranty coverage contingent upon proof of proper maintenance.

WHAT MERCURY WILL DO: Mercury's sole and exclusive obligation under this warranty is limited to, at our option, repairing a corroded part, replacing such part or parts with new or Mercury Marine certified remanufactured parts, or refunding the purchase price of the Mercury product. Mercury reserves the right to improve or modify products from time to time without assuming an obligation to modify products previously manufactured.

WARRANTY INFORMATION

HOW TO OBTAIN WARRANTY COVERAGE: The customer must provide Mercury with a reasonable opportunity to repair, and reasonable access to the product for warranty service. Warranty claims shall be made by delivering the product for inspection to a Mercury dealer authorized to service the product. If purchaser cannot deliver the product to such a dealer, written notice must be given to Mercury. We will then arrange for the inspection and any covered repair. Purchaser, in that case, shall pay for all related transportation charges and/or travel time. If the service provided is not covered by this warranty, purchaser shall pay for all related labor and material, and any other expenses associated with that service. Purchaser shall not, unless requested by Mercury, ship the product or parts of the product directly to Mercury. Proof of registered ownership must be presented to the dealer at the time warranty service is requested in order to obtain coverage.

WHAT IS NOT COVERED: This limited warranty does not cover electrical system corrosion; corrosion resulting from damage, corrosion which causes purely cosmetic damage, abuse, or improper service; corrosion to accessories, instruments, steering systems; corrosion to factory installed jet drive unit; damage due to marine growth; product sold with less than a one year limited Product warranty; replacement parts (parts purchased by customer); products used in a commercial application. Commercial use is defined as any work or employment related use of the product, or any use of the product which generates income, for any part of the warranty period, even if the product is only occasionally used for such purposes.

WARRANTY INFORMATION

Corrosion damage caused by stray electrical currents (onshore power connections, nearby boats, submerged metal) is not covered by this corrosion warranty and should be protected against by the use of a corrosion protection system, such as the Mercury Precision Parts or Quicksilver MerCathode system and/or Galvanic Isolator. Corrosion damage caused by improper application of copper base antifouling paints is also not covered by this limited warranty. If antifouling protection is required, Tri-Butyl-Tin-Adipate (TBTA) base antifouling paints are recommended on Outboard and MerCruiser boating applications. In areas where TBTA base paints are prohibited by law, copper base paints can be used on the hull and transom. Do not apply paint to the outboard or MerCruiser product. In addition, care must be taken to avoid an electrical interconnection between the warranted product and the paint. For MerCruiser product, an unpainted gap of at least 38 mm (1.5 in.) should be left around the transom assembly. Refer to the Operation and Maintenance Manual for additional details.

For additional information regarding events and circumstances covered by this warranty, and those that are not, see the Warranty Coverage section of the Operation and Maintenance Manual, incorporated by reference into this warranty.

DISCLAIMERS AND LIMITATIONS:

THE IMPLIED WARRANTIES OF MERCHANTABILITY AND FITNESS FOR A PARTICULAR PURPOSE ARE EXPRESSLY DISCLAIMED. TO THE EXTENT THAT THEY CANNOT BE DISCLAIMED, THE IMPLIED WARRANTIES ARE LIMITED IN DURATION TO THE LIFE OF THE EXPRESS WARRANTY. INCIDENTAL AND CONSEQUENTIAL DAMAGES ARE EXCLUDED FROM COVERAGE UNDER THIS WARRANTY. SOME STATES/COUNTRIES DO NOT ALLOW FOR THE DISCLAIMERS, LIMITATIONS AND EXCLUSIONS IDENTIFIED ABOVE, AS A RESULT, THEY MAY NOT APPLY TO YOU. THIS WARRANTY GIVES YOU SPECIFIC LEGAL RIGHTS, AND YOU MAY ALSO HAVE OTHER LEGAL RIGHTS WHICH VARY FROM STATE TO STATE AND COUNTRY TO COUNTRY.

WARRANTY INFORMATION

Warranty Coverage and Exclusions

The purpose of this section is to help eliminate some of the more common misunderstandings regarding warranty coverage. The following information explains some of the types of services that are not covered by warranty. The provisions set forth following have been incorporated by reference into the Three Year Limited Warranty Against Corrosion Failure, the International Limited Outboard Warranty, and the United States and Canada Limited Outboard Warranty.

Keep in mind that warranty covers repairs that are needed within the warranty period because of defects in material and workmanship. Installation errors, accidents, normal wear, and a variety of other causes that affect the product are not covered.

Warranty is limited to defects in material or workmanship, but only when the consumer sale is made in the country to which distribution is authorized by us.

Should you have any questions concerning warranty coverage, contact your authorized dealer. They will be pleased to answer any questions that you may have.

GENERAL EXCLUSIONS FROM WARRANTY

1. Minor adjustments and tune-ups, including checking, cleaning, or adjusting spark plugs, ignition components, carburetor settings, filters, belts, controls, and checking lubrication made in connection with normal services.
2. Factory installed jet drive units - Specific parts excluded from the warranty are: the jet drive impeller and jet drive liner damaged by impact or wear, and water damaged driveshaft bearings as a result of improper maintenance.
3. Damage caused by neglect, lack of maintenance, accident, abnormal operation, or improper installation or service.
4. Haul-out, launch, towing charges, removal and/or replacement of boat partitions or material because of boat design for necessary access to the product, all related transportation charges and/or travel time, etc. Reasonable access must be provided to the product for warranty service. Customer must deliver product to an authorized dealer.

WARRANTY INFORMATION

5. Additional service work requested by customer other than that necessary to satisfy the warranty obligation.
6. Labor performed by other than an authorized dealer may be covered only under the following circumstances: when performed on emergency basis (providing there are no authorized dealers in the area who can perform the work required or have no facilities to haul-out, etc., and prior factory approval has been given to have the work performed at this facility).
7. All incidental and/or consequential damages (storage charges, telephone or rental charges of any type, inconvenience or loss of time or income) are the owner's responsibility.
8. Use of other than Mercury Precision or Quicksilver parts when making warranty repairs.
9. Oils, lubricants, or fluids changed as a matter of normal maintenance is customer's responsibility unless loss or contamination of same is caused by product failure that would be eligible for warranty consideration.
10. Participating in or preparing for racing or other competitive activity or operating with a racing type lower unit.
11. Engine noise does not necessarily indicate a serious engine problem. If diagnosis indicates a serious internal engine condition which could result in a failure, condition responsible for noise should be corrected under the warranty.
12. Lower unit and/or propeller damage caused by striking a submerged object is considered a marine hazard.
13. Water entering engine through the fuel intake, air intake, or exhaust system or submersion.
14. Failure of any parts caused by lack of cooling water, which results from starting motor out of water, foreign material blocking inlet holes, motor being mounted too high, or trimmed too far out.
15. Use of fuels and lubricants which are not suitable for use with or on the product. Refer to the **Maintenance** section.

WARRANTY INFORMATION

16. Our limited warranty does not apply to any damage to our products caused by the installation or use of parts and accessories which are not manufactured or sold by us. Failures which are not related to the use of those parts or accessories are covered under warranty if they otherwise meet the terms of the limited warranty for that product.

U.S. EPA Emissions Limited Warranty

Consistent with the obligations created by 40 CFR Part 1045, Subpart B, Mercury Marine provides a five year or 175 hours of engine use, whichever occurs first, to the retail customer, that the engine is designed, built, and equipped so as to conform at the time of sale with applicable regulations under section 213 of the Clean Air Act, and that the engine is free from defects in materials and workmanship which cause the engine to fail to conform with applicable regulations. This emission-related warranty covers all the components listed in the **Emission Control System Components**.

Emission Control System Components

The EPA and California emission-related warranty covers all the following list of components:

COMPONENTS OF THE EMISSIONS CONTROL SYSTEM:

1. Fuel metering system
 - a. Carburetor and internal parts (and/or pressure regulator or fuel injection system)
 - b. Cold start enrichment system
 - c. Intake valves
2. Air induction system
 - a. Intake manifold
 - b. Turbocharger or supercharger systems (where applicable)
3. Ignition system
 - a. Spark plugs
 - b. Magneto or electronic ignition system
 - c. Spark advance/retard system

WARRANTY INFORMATION

- d. Ignition coil and/or control module
- e. Ignition wires
- 4. Lubrication system (4-Stroke engines excluded)
 - a. Oil pump and internal parts
 - b. Oil injectors
 - c. Oil meter
- 5. Exhaust system
 - a. Exhaust manifold
 - b. Exhaust valves
- 6. Miscellaneous items used in above systems
 - a. Hoses, clamps, fittings, tubing, sealing gaskets or devices, and mounting hardware
 - b. Pulleys, belts, and idlers
 - c. Vacuum, temperature, check and time sensitive valves and switches
 - d. Electronic controls

The emission-related warranty does not cover components whose failure would not increase an engine's emissions on any regulated pollutant.

California Emissions Limited Warranty

The California Air Resources Board has promulgated air emission regulations for outboard engines. The regulations apply to all outboard engines sold to retail consumers in California, and which were manufactured for the 2001 model year and later. Mercury Marine, in compliance with those regulations, provides this limited warranty for the emission control systems (see the components listed in the **Emission Control System Components**), and further warrants that the outboard engine was designed, built, and equipped to conform with all applicable regulations adopted by the California Air Resources Board pursuant to its authority in Chapters 1 and 2, Part 5, Division 26 of the Health and Safety Code. For information regarding the limited warranty for the nonemission-related components of the outboard, please see the limited warranty statement for your outboard.

WARRANTY INFORMATION

WHAT IS COVERED: Mercury Marine warrants the components of the emissions control systems (see the components listed in the **Emission Control System Components**) of its new, 2001 model year and later outboards, sold by a California dealer to retail customers residing in California, to be free from defects in material or workmanship, that cause the failure of a warranted part to be identical in all material respects to that part as described in the application of Mercury Marine for certification from the California Air Resources Board, for the period of time, and under the conditions, identified below. The cost to diagnose a warranty failure is covered under the warranty (if the warranty claim is approved). Damage to other engine components caused by the failure of a warranted part will also be repaired under warranty.

DURATION OF COVERAGE: This limited warranty provides coverage for the components of the emissions control systems of new, 2001 model year and later outboards, sold to retail customers in California for four (4) years from either the date the product is first sold, or first put into service, whichever occurs first, or the accumulation of 250 hours of engine operation (as determined by the engine's hour meter, if any). Emission-related normal maintenance items such as spark plugs and filters, that are on the warranted parts list, are warranted up to their first required replacement interval only. Refer to **Emission Control System Components and Maintenance Schedule**. The repair or replacement of parts, or the performance of service under this warranty, does not extend the life of this warranty beyond its original expiration date. Unexpired warranty coverage can be transferred to a subsequent purchaser. (See instructions on transfer of warranty.)

WARRANTY INFORMATION

HOW TO OBTAIN WARRANTY COVERAGE: The customer must provide Mercury with a reasonable opportunity to repair and reasonable access to the product for warranty service. Warranty claims shall be made by delivering the product for inspection to a Mercury dealer authorized to service the product. If purchaser cannot deliver the product to such a dealer, please notify Mercury Marine and Mercury will then arrange for the inspection and any covered repair. Purchaser, in that case, shall pay for all related transportation charges and/or travel time. If the service provided is not covered by this warranty, purchaser shall pay for all related labor and material, and any other expenses associated with that service. Purchaser shall not, unless requested by Mercury, ship the product or parts of the product directly to Mercury.

WHAT MERCURY WILL DO: Mercury Marine's sole and exclusive obligation under this warranty is limited to, at our expense and at our option, repairing or replacing defective parts with new or Mercury Marine certified remanufactured parts, or refunding the purchase price of the Mercury product. Mercury reserves the right to improve or modify products from time to time without assuming an obligation to modify products previously manufactured.

WHAT IS NOT COVERED: This limited warranty does not cover routine maintenance items, tune-ups, adjustments, normal wear and tear, damage caused by abuse, abnormal use, use of a propeller or gear ratio that does not allow the engine to run in its recommended wide-open throttle RPM range (see **General Information - Specifications**), operation of the product in a manner inconsistent with the recommended operation procedures, neglect, accident, submersion, improper installation (proper installation specifications and techniques are set forth in the installation instructions for the product), improper service, jet pump impellers and liners, operation with fuels, oils, or lubricants which are not suitable for use with the product (see **Fuel and Oil**), alteration or removal of parts.

WARRANTY INFORMATION

Expenses related to haul-out, launch, towing, storage, telephone, rental, inconvenience, slip fees, insurance coverage, loan payments, loss of time, loss of income, or any other type of incidental or consequential damages are not covered by this warranty. Also, expenses associated with the removal and/or replacement of boat partitions or material caused by boat design for access to the product are not covered by this warranty.

Nonwarranty maintenance, replacement, or repair of emission control devices and systems may be performed by any marine engine repair establishment or individual. The use of non-Mercury parts for nonwarranty maintenance or repairs will not be grounds for disallowing other warranty work. The use of add-on (as defined at section 1900 (b)(1) and (b)(10) of Title 13 of the California Code of Regulations) or modified parts not exempted by the California Air Resources Board may be grounds for disallowing a warranty claim, at the discretion of Mercury Marine. Failures of warranted parts caused by the use of a nonexempted add-on or modified part will not be covered.

DISCLAIMERS AND LIMITATIONS

THE IMPLIED WARRANTIES OF MERCHANTABILITY AND FITNESS FOR A PARTICULAR PURPOSE ARE EXPRESSLY DISCLAIMED. TO THE EXTENT THAT THEY CANNOT BE DISCLAIMED, THE IMPLIED WARRANTIES ARE LIMITED IN DURATION TO THE LIFE OF THE EXPRESS WARRANTY. INCIDENTAL AND CONSEQUENTIAL DAMAGES ARE EXCLUDED FROM COVERAGE UNDER THIS WARRANTY. SOME STATES/COUNTRIES DO NOT ALLOW FOR THE DISCLAIMERS, LIMITATIONS AND EXCLUSIONS IDENTIFIED ABOVE, AS A RESULT, THEY MAY NOT APPLY TO YOU. THIS WARRANTY GIVES YOU SPECIFIC LEGAL RIGHTS, AND YOU MAY ALSO HAVE OTHER LEGAL RIGHTS WHICH VARY FROM STATE TO STATE AND COUNTRY TO COUNTRY.

If you have any questions regarding your warranty rights and responsibilities, you should contact Mercury Marine at 1-920-929-5040.

WARRANTY INFORMATION

California Air Resources Board Explanation of Your California Emission Control Warranty Statement

YOUR WARRANTY RIGHTS AND OBLIGATIONS: The California Air Resources Board is pleased to explain the emission control system warranty on your 2012–2013 model year outboard engine. In California, new outboard engines must be designed, built, and equipped to meet the State's stringent anti-smog standards. Mercury Marine must warrant the emission control system on your outboard engine for the periods of time listed below, provided there has been no abuse, neglect, or improper maintenance of your outboard engine.

Your emission control system may include parts such as the carburetor or fuel injection system, the ignition system, and catalytic converter. Also included may be hoses, belts, connectors, and other emission-related assemblies.

Where a warrantable condition exists, Mercury Marine will repair your outboard engine at no cost to you, including diagnosis, parts, and labor.

MANUFACTURER'S WARRANTY COVERAGE: Select emission control parts from model year 2001 and later outboard engines are warranted for four (4) years, or for 250 hours of use, whichever first occurs. However, warranty coverage based on the hourly period is only permitted for outboard engines and personal watercraft equipped with hour meters as defined in s 2441(a)(13) or their equivalent. If any emission-related part on your engine is defective under warranty, the part will be repaired or replaced by Mercury Marine.

OWNER'S WARRANTY RESPONSIBILITIES: As the outboard engine owner, you are responsible for the performance of the required maintenance listed in the **Maintenance** section. Mercury Marine recommends that you retain all receipts covering maintenance on your outboard engine, but Mercury Marine cannot deny warranty solely for the lack of receipts or your failure to ensure the performance of all scheduled maintenance.

WARRANTY INFORMATION

As the outboard engine owner, you should, however, be aware that Mercury Marine may deny you warranty coverage if your outboard engine or a part has failed due to abuse, neglect, improper maintenance, or unapproved modifications.

You are responsible for presenting your outboard to a Mercury dealer authorized to service the product as soon as a problem exists. The warranty repairs will be completed in a reasonable amount of time, not to exceed 30 days.

If you have any questions regarding your warranty rights and responsibilities, you should contact Mercury Marine at 1-920-929-5040.

Emission Certification Star Label



Outboards are labeled on the cowl with one of the following star labels.

The symbol for a cleaner marine engine means:

Cleaner air and water - for a healthier lifestyle and environment.

Better fuel economy - burns up to 30–40 percent less gas and oil than conventional carbureted two-stroke engines, saving money and resources.

Longer emission warranty - protects consumer for worry-free operation.

 <p>The label features a black oval with a white star in the center. The word "LOW" is at the top, "EMISSION" is at the bottom, and "CALIFORNIA EMISSIONS STANDARDS" is written around the star. A small number "22531" is to the right.</p>	<p>One Star - Low Emission</p> <p>The One Star label identifies engines that meet the Air Resources Board's 2001 exhaust emissions standards. Engines meeting these standards have 75% lower emissions than conventional carbureted two-stroke engines. These engines are equivalent to the U.S. EPA's 2006 standards for marine engines.</p>
 <p>The label features a circular design with two stars. The words "VERY LOW" are at the top, "EMISSION" is at the bottom, and "FOUR" is in the center. A small number "42537" is to the right.</p>	<p>Two Stars - Very Low Emission</p> <p>The Two Star label identifies engines that meet the Air Resources Board's Personal Watercraft and Outboard marine engine 2004 exhaust emissions standards. Engines meeting these standards have 20% lower emissions than One Star - Low Emission engines.</p>

WARRANTY INFORMATION



Three Stars - Ultra Low Emission

The Three Star label identifies engines that meet the Air Resources Board's Personal Watercraft and Outboard marine engine 2008 exhaust emissions standards or the Sterndrive and Inboard marine engine 2003-2008 exhaust emission standards. Engines meeting these standards have 65% lower emissions than One Star - Low Emission engines.



Four Stars - Super Ultra Low Emission

The Four Star label identifies engines that meet the Air Resources Board's Sterndrive and Inboard marine engine 2009 exhaust emission standards. Personal Watercraft and Outboard marine engines may also comply with these standards. Engines meeting these standards have 90% lower emissions than One Star - Low Emission engines.

Warranty Policies Outside The United States and Canada

MERCURY/MARINER OUTBOARD LIMITED WARRANTY-AUSTRALIA AND NEW ZEALAND POLICY

This limited warranty is given by Marine Power International Pty Ltd ACN 003 100 007 of 41-71 Bessemer Drive, Dandenong South, Victoria 3175 Australia (telephone (61) (3) 9791 5822) e-mail: merc_info@mercmarine.com.

What is Covered

Mercury Marine warrants its new products to be free of defects in material and workmanship during the period described below. The benefits to the consumer given by the warranty are in addition to other rights and remedies of the consumer under a law in relation to the goods or services to which the warranty relates.

WARRANTY INFORMATION

Guarantees Under Australian Consumer Law

Our goods come with guarantees that cannot be excluded under the Australian Consumer Law. You are entitled to a replacement or refund for a major failure and compensation for any other reasonably foreseeable loss or damage. You are also entitled to have the goods repaired or replaced if the goods fail to be of acceptable quality and the failure does not amount to a major failure.

Warranty Period for Recreational Use

This Limited Warranty provides coverage for three (3) years from the date the product is first sold to a recreational use retail purchaser, or the date on which the product is first put into service, whichever occurs first. Unexpired warranty coverage can be transferred to a subsequent recreational use customer upon proper registration of the product.

Warranty Period for Commercial Use

Commercial users of these products receive warranty coverage under this Limited Warranty of one (1) year from the date of first retail sale, or one (1) year from the date on which the product was first put into service, whichever occurs first. Commercial use is defined as any work or employment related use of the product, or any use of the product which generates income, for any part of the warranty period, even if the product is only occasionally used for such purposes. Unexpired warranty coverage cannot be transferred either to or from a commercial use customer.

WARRANTY INFORMATION

Conditions That Must Be Met to Obtain Warranty Coverage

Warranty coverage under this Limited Warranty is available only to retail customers that purchase from a Dealer authorized by Mercury Marine to distribute the product in the country in which the sale occurred, and then only after the Mercury Marine specified predelivery inspection process is completed and documented. Warranty coverage becomes available upon proper registration of the product by the authorized dealer. Inaccurate warranty registration information regarding recreational use, or subsequent change of use from recreational to commercial (unless properly registered) may void the warranty at the sole discretion of Mercury Marine. Routine maintenance outlined in the Operation and Maintenance Manual must be timely performed in order to maintain warranty coverage. Mercury Marine reserves the right to make warranty coverage contingent upon proof of proper maintenance.

What Mercury Will Do

Mercury Marine's sole and exclusive obligation under this Limited Warranty is limited to, at our option, repairing a defective part, replacing such part or parts with new or Mercury Marine certified remanufactured parts, or refunding the purchase price of the Mercury Marine product. Mercury Marine reserves the right to improve or modify products from time to time without assuming an obligation to modify products previously manufactured.

WARRANTY INFORMATION

How to Obtain Warranty Coverage Under This Limited Warranty

The customer must provide Mercury Marine with a reasonable opportunity to repair and reasonable access to the product for warranty service. Warranty claims shall be made by delivering the product for inspection to a Mercury Marine dealer authorized to service the product. A list of dealers and their contact details is available at www.mercurymarine.com.au. If the purchaser cannot deliver the product to such a dealer, written notice must be given to Mercury Marine at the address shown above. Mercury Marine will then arrange for the inspection and any covered repair. This Limited Warranty will not cover the purchaser for all related transportation charges and travel time. If the service provided is not covered by this limited warranty, the purchaser shall pay for all related labor and material and any other expenses associated with that service, provided that a consumer will not be obligated to pay where the service has been carried out to remedy a failure of an acceptable quality guarantee which is binding on Mercury Marine under the Australian Consumer Law. The purchaser shall not, unless requested by Mercury Marine, ship the product or parts of the product directly to Mercury Marine. Proof of registered ownership must be presented to the dealer at the time warranty service is requested in order to obtain coverage under this Limited Warranty.

WARRANTY INFORMATION

What is Not Covered

This limited warranty does not cover routine maintenance items, tune-ups, adjustments, normal wear and tear, damage caused by abuse, abnormal use, use of a propeller or gear ratio that does not allow the engine to run in its recommended wide-open throttle RPM range (see the Operation and Maintenance Manual), operation of the product in a manner inconsistent with the recommended operation/duty cycle section of the Operation and Maintenance Manual, neglect, accident, submersion, improper installation (proper installation specifications and techniques are set forth in the installation instructions for the product), improper service, use of an accessory or part not manufactured or sold by us, jet pump impellers and liners, operation with fuels, oils or lubricants which are not suitable for use with the product (see the Operation and Maintenance Manual), alteration or removal of parts, water entering the engine through the fuel intake, air intake or exhaust system, or damage to the product from insufficient cooling water caused by blockage of the cooling system by a foreign body, running the engine out of water, mounting the engine too high on the transom, or running the boat with the engine trimmed out too far. Use of the product for racing or other competitive activity, or operating with a racing type lower unit, at any point, even by a prior owner of the product, voids the warranty.

Expenses related to haul-out, launch, towing, storage, telephone, rental, inconvenience, slip fees, insurance coverage, loan payments, loss of time, loss of income, or any other type of incidental or consequential damages are not covered by this Limited Warranty. Also, expenses associated with the removal and/or replacement of boat partitions or material caused by boat design for access to the product are not covered by this warranty.

WARRANTY INFORMATION

No individual or entity, including Mercury Marine authorized dealers, has been given authority by Mercury Marine to make any affirmation, representation or warranty regarding the product, other than those contained in this limited warranty, and if made, shall not be enforceable against Mercury Marine. For additional information regarding events and circumstances covered by this warranty, and those that are not, see the Warranty Coverage section of the Operation and Maintenance Manual, incorporated by reference into this warranty.

Expense of Claiming This Limited Warranty

This Limited Warranty does not cover any expenses you may incur claiming the warranty.

DISCLAIMERS AND LIMITATIONS:
EXCEPT FOR APPLICABLE GUARANTEES AND OTHER RIGHTS AND REMEDIES THAT A CONSUMER MAY HAVE UNDER THE AUSTRALIAN CONSUMER LAW OR OTHER LAW IN RELATION TO WHICH THE PRODUCTS RELATE, THE IMPLIED WARRANTIES OF MERCHANTABILITY AND FITNESS FOR A PARTICULAR PURPOSE ARE EXPRESSLY DISCLAIMED. TO THE EXTENT THAT THEY CANNOT BE DISCLAIMED, THE IMPLIED WARRANTIES ARE LIMITED IN DURATION TO THE LIFE OF THE EXPRESS WARRANTY. INCIDENTAL AND CONSEQUENTIAL DAMAGES ARE EXCLUDED FROM COVERAGE UNDER THIS LIMITED WARRANTY.

TRANSFER OF WARRANTY—AUSTRALIA AND NEW ZEALAND POLICY

The limited warranty is transferable to a subsequent purchaser, but only for the remainder of the unused portion of the limited warranty. This will not apply to products used for commercial applications.

To transfer the warranty to the subsequent owner, send or fax a copy of the Bill of Sale or Purchase Agreement, new owner's name, address, and hull identification number (HIN) to Mercury Marine's Warranty Registration Department. In Australia and New Zealand, mail to:

WARRANTY INFORMATION

Mercury Marine
Attn: Warranty Registration Department
Brunswick Asia Pacific Group
Private Bag 1420
Dandenong South, Victoria 3164
Australia

Upon processing the transfer of warranty, Mercury Marine will send registration verification to the new owner of the product by mail. There is no charge for this service.

You may change your address at any time, including at the time of the warranty claim, by calling Mercury Marine or sending a letter or fax with your name, old address, new address, and hull identification number (HIN) to Mercury Marine's Warranty Registration Department.

FOURSTROKE OUTBOARD LIMITED WARRANTY EUROPE AND CONFEDERATION OF INDEPENDENT STATES

Outside Europe and Confederation of Independent States - check with local distributor.

WHAT IS COVERED: Mercury Marine warrants its new products to be free of defects in material and workmanship during the period described below.

WARRANTY INFORMATION

DURATION OF COVERAGE: This Limited Warranty provides coverage for two (2) years from the date the product is first sold to a recreational use retail purchaser, or the date on which the product is first put into service, whichever occurs first.

Commercial users of these products receive warranty coverage of one (1) year from the date of first retail sale, or one (1) year from the date in which the product was first put into service, whichever occurs first. Commercial use is defined as any work or employment related use of the product, or any use of the product which generates income, for any part of the warranty period, even if the product is only occasionally used for such purposes.

The repair or replacement of parts, or the performance of service under this warranty, does not extend the life of this warranty beyond its original expiration date. Unexpired warranty coverage can be transferred from one recreational use customer to a subsequent recreational use customer upon proper reregistration of the product. Unexpired warranty coverage cannot be transferred either to or from a commercial use customer.

Warranty coverage may be terminated for used or repossessed product; or product purchased at auction, from a salvage yard, or from an insurance company.

CONDITIONS THAT MUST BE MET IN ORDER TO OBTAIN WARRANTY COVERAGE: Warranty coverage is available only to retail customers that purchase from a Dealer authorized by Mercury Marine to distribute the product in the country in which the sale occurred, and then only after the Mercury Marine specified predelivery inspection process is completed and documented. Warranty coverage becomes available upon proper registration of the product by the authorized dealer. Routine maintenance outlined in the Operation and Maintenance Manual must be timely performed in order to maintain warranty coverage. Mercury Marine reserves the right to make future warranty coverage contingent on proof of proper maintenance.

WARRANTY INFORMATION

WHAT MERCURY WILL DO: Mercury's sole and exclusive obligation under this warranty is limited to, at our option, repairing a defective part, replacing such part or parts with new or Mercury Marine certified remanufactured parts, or refunding the purchase price of the Mercury product. Mercury reserves the right to improve or modify products from time to time without assuming an obligation to modify products previously manufactured.

HOW TO OBTAIN WARRANTY COVERAGE: The customer must provide Mercury with a reasonable opportunity to repair, and reasonable access to the product for warranty service. Warranty claims shall be made by delivering the product for inspection to a Mercury dealer authorized to service the product. If purchaser cannot deliver the product to such a dealer, written notice must be given to Mercury. We will then arrange for the inspection and any covered repair. Purchaser in that case shall pay for all related transportation charges and/or travel time. If the service provided is not covered by this warranty, purchaser shall pay for all related labor and material, and any other expenses associated with that service. Purchaser shall not, unless requested by Mercury, ship the product or parts of the product directly to Mercury. Proof of registered ownership must be presented to the dealer at the time warranty service is requested in order to obtain coverage.

WARRANTY INFORMATION

WHAT IS NOT COVERED: This limited warranty does not cover routine maintenance items, tune-ups, adjustments, normal wear and tear, damage caused by abuse, abnormal use, use of a propeller or gear ratio that does not allow the engine to run in its recommended wide-open throttle RPM range (see the Operation and Maintenance Manual), operation of the product in a manner inconsistent with the recommended operation/duty cycle section of the Operation and Maintenance Manual, neglect, accident, submersion, improper installation (proper installation specifications and techniques are set forth in the installation instructions for the product), improper service, use of an accessory or part not manufactured or sold by us, jet pump impellers and liners, operation with fuels, oils or lubricants which are not suitable for use with the product (see the Operation and Maintenance Manual), alteration or removal of parts, or water entering the engine through the fuel intake, air intake or exhaust system, or damage to the product from insufficient cooling water caused by blockage of the cooling system by a foreign body, running the engine out of water, mounting the engine too high on the transom, or running the boat with the engine trimmed out too far. Use of the product for racing or other competitive activity, or operating with a racing type lower unit, at any point, even by a prior owner of the product, voids the warranty.

Expenses related to haul out, launch, towing, storage, telephone, rental, inconvenience, slip fees, insurance coverage, loan payments, loss of time, loss of income, or any other type of incidental or consequential damages are not covered by this warranty. Also, expenses associated with the removal and/or replacement of boat partitions or material caused by boat design for access to the product are not covered by this warranty.

No individual or entity, including Mercury Marine authorized dealers, has been given authority by Mercury Marine to make any affirmation, representation or warranty regarding the product, other than those contained in this limited warranty, and if made, shall not be enforceable against Mercury Marine.

WARRANTY INFORMATION

For additional information regarding events and circumstances covered by this warranty, and those that are not, see the Warranty Coverage section of the Operation and Maintenance Manual, incorporated by reference into this warranty.

DISCLAIMERS AND LIMITATIONS:

THE IMPLIED WARRANTIES OF MERCHANTABILITY AND FITNESS FOR A PARTICULAR PURPOSE ARE EXPRESSLY DISCLAIMED. TO THE EXTENT THAT THEY CANNOT BE DISCLAIMED, THE IMPLIED WARRANTIES ARE LIMITED IN DURATION TO THE LIFE OF THE EXPRESS WARRANTY. INCIDENTAL AND CONSEQUENTIAL DAMAGES ARE EXCLUDED FROM COVERAGE UNDER THIS WARRANTY. SOME STATES/COUNTRIES DO NOT ALLOW FOR THE DISCLAIMERS, LIMITATIONS AND EXCLUSIONS IDENTIFIED ABOVE, AS A RESULT, THEY MAY NOT APPLY TO YOU. THIS WARRANTY GIVES YOU SPECIFIC LEGAL RIGHTS, AND YOU MAY ALSO HAVE OTHER LEGAL RIGHTS WHICH VARY FROM STATE TO STATE AND COUNTRY TO COUNTRY.

FOURSTROKE OUTBOARD LIMITED WARRANTY MIDDLE-EAST AND AFRICA (EXCLUDING VERADO)

WHAT IS COVERED: Mercury Marine warrants its new Outboard and Jet Products to be free of defects in material and workmanship during the period described below.

WARRANTY INFORMATION

DURATION OF COVERAGE: This Limited Warranty provides coverage for one (2) year from the date the product is first sold to a recreational use retail purchaser, or the date on which the product is first put into service, whichever occurs first.

Commercial users of these products receive warranty coverage of one (1) years from the date of first retail sale, or one (1) year from the date on which the product was first put into service, whichever occurs first. Commercial use is defined as any work or employment related use of the product, or any use of the product which generates income, for any part of the warranty period, even if the product is only occasionally used for such purposes. The repair or replacement of parts, or the performance of service under this warranty, does not extend the life of this warranty beyond its original expiration date. Unexpired warranty coverage can be transferred from one recreational use customer to a subsequent recreational use customer upon proper reregistration of the product. Unexpired warranty coverage cannot be transferred either to or from a commercial use customer.

CONDITIONS THAT MUST BE MET IN ORDER TO OBTAIN WARRANTY COVERAGE: Warranty coverage is available only to retail customers that purchase from a Dealer authorized by Mercury Marine to distribute the product in the country in which the sale occurred, and then only after the Mercury Marine specified predelivery inspection process is completed and documented. Warranty coverage becomes available upon proper registration of the product by the authorized dealer. Routine maintenance outlined in the Operation and Maintenance Manual must be timely performed in order to maintain warranty coverage. Mercury Marine reserves the right to make warranty coverage contingent on proof of proper maintenance.

WHAT MERCURY WILL DO: Mercury's sole and exclusive obligation under this warranty is limited to, at our option, repairing a defective part, replacing such part or parts with new or Mercury Marine certified remanufactured parts, or refunding the purchase price of the Mercury product. Mercury reserves the right to improve or modify products from time to time without assuming an obligation to modify products previously manufactured.

WARRANTY INFORMATION

HOW TO OBTAIN WARRANTY COVERAGE: The customer must provide Mercury with a reasonable opportunity to repair, and reasonable access to the product for warranty service. Warranty claims shall be made by delivering the product for inspection to a Mercury dealer authorized to service the product. If purchaser cannot deliver the product to such a dealer, written notice must be given to Mercury. We will then arrange for the inspection and any covered repair. Purchaser in that case shall pay for all related transportation charges and/or travel time. If the service provided is not covered by this warranty, purchaser shall pay for all related labor and material, and any other expenses associated with that service. Purchaser shall not, unless requested by Mercury, ship the product or parts of the product directly to Mercury. Proof of registered ownership must be presented to the dealer at the time warranty service is requested in order to obtain coverage.

WHAT IS NOT COVERED: This limited warranty does not cover routine maintenance items, tune-ups, adjustments, normal wear and tear, damage caused by abuse, abnormal use, use of a propeller or gear ratio that does not allow the engine to run in its recommended wide-open throttle RPM range (see the Operation and Maintenance Manual), operation of the product in a manner inconsistent with the recommended operation/duty cycle section of the Operation and Maintenance Manual, neglect, accident, submersion, improper installation (proper installation specifications and techniques are set forth in the installation instructions for the product), improper service, use of an accessory or part not manufactured or sold by us, jet pump impellers and liners, operation with fuels, oils or lubricants which are not suitable for use with the product (see the Operation and Maintenance Manual), alteration or removal of parts, or water entering the engine through the fuel intake, air intake or exhaust system, or damage to the product from insufficient cooling water caused by blockage of the cooling system by foreign body, running the engine out of water, mounting the engine too high on the transom, or running the boat with the engine trimmed out too far.

WARRANTY INFORMATION

Use of the product for racing or other competitive activity, or operating with a racing type lower unit, at any point, even by a prior owner of the product, voids the warranty.

Expenses related to haul out, launch, towing, storage, telephone, rental, inconvenience, slip fees, insurance coverage, loan payments, loss of time, loss of income, or any other type of incidental or consequential damages are not covered by this warranty. Also, expenses associated with the removal and/or replacement of boat partitions or material caused by boat design for access to the product are not covered by this warranty.

No individual or entity, including Mercury Marine authorized dealers, has been given authority by Mercury Marine to make any affirmation, representation or warranty regarding the product, other than those contained in this limited warranty, and if made, shall not be enforceable against Mercury Marine.

For additional information regarding events and circumstances covered by this warranty, and those that are not, see the Warranty Coverage section of the Operation and Maintenance Manual, incorporated by reference into this warranty.

DISCLAIMERS AND LIMITATIONS:

THE IMPLIED WARRANTIES OF MERCHANTABILITY AND FITNESS FOR A PARTICULAR PURPOSE ARE EXPRESSLY DISCLAIMED. TO THE EXTENT THAT THEY CANNOT BE DISCLAIMED, THE IMPLIED WARRANTIES ARE LIMITED IN DURATION TO THE LIFE OF THE EXPRESS WARRANTY. INCIDENTAL AND CONSEQUENTIAL DAMAGES ARE EXCLUDED FROM COVERAGE UNDER THIS WARRANTY. SOME STATES/COUNTRIES DO NOT ALLOW FOR THE DISCLAIMERS, LIMITATIONS AND EXCLUSIONS IDENTIFIED ABOVE, AS A RESULT, THEY MAY NOT APPLY TO YOU. THIS WARRANTY GIVES YOU SPECIFIC LEGAL RIGHTS, AND YOU MAY ALSO HAVE OTHER LEGAL RIGHTS WHICH VARY FROM STATE TO STATE AND COUNTRY TO COUNTRY.

GENERAL INFORMATION

Boater's Responsibilities

The operator (driver) is responsible for the correct and safe operation of the boat and the safety of its occupants and general public. It is strongly recommended that each operator read and understand this entire manual before operating the outboard.

Be sure that at least one additional person onboard is instructed in the basics of starting and operating the outboard and boat handling in case the driver is unable to operate the boat.

Before Operating Your Outboard

Read this manual carefully. Learn how to operate your outboard properly. If you have any questions, contact your dealer.

Safety and operating information that is practiced, along with using good common sense, can help prevent personal injury and product damage.

This manual as well as safety labels posted on the outboard use the following safety alerts to draw your attention to special safety instructions that should be followed.

DANGER

Indicates a hazardous situation which, if not avoided, will result in death or serious injury.

WARNING

Indicates a hazardous situation which, if not avoided, could result in death or serious injury.

CAUTION

Indicates a hazardous situation which, if not avoided, could result in minor or moderate injury.

NOTICE

Indicates a situation which, if not avoided, could result in engine or major component failure.

GENERAL INFORMATION

Boat Horsepower Capacity

WARNING

Exceeding the boat's maximum horsepower rating can cause serious injury or death. Overpowering the boat can affect boat control and flotation characteristics or break the transom. Do not install an engine that exceeds the boat's maximum power rating.

Do not overpower or overload your boat. Most boats will carry a required capacity plate indicating the maximum acceptable power and load as determined by the manufacturer following certain federal guidelines. If in doubt, contact your dealer or the boat manufacturer.

U.S. COAST GUARD CAPACITY	
MAXIMUM HORSEPOWER	XXX
MAXIMUM PERSON CAPACITY (POUNDS)	XXX
MAXIMUM WEIGHT CAPACITY	XXX

26777

High-Speed and High-Performance Boat Operation

If your outboard is to be used on a high-speed or high-performance boat with which you are unfamiliar, we recommend that you never operate it at its high speed capability without first requesting an initial orientation and familiarization demonstration ride with your dealer or an operator experienced with your boat/outboard combination. For additional information, obtain a copy of our **Hi-Performance Boat Operation** booklet from your dealer, distributor, or Mercury Marine.

GENERAL INFORMATION

Outboard Remote Control Models

The remote control connected to your outboard must be equipped with a start in neutral only protection device. This prevents the engine from starting when the shift is actuated in any position other than neutral.

WARNING

Starting the engine with the drive in gear can cause serious injury or death. Never operate a boat that does not have a neutral-safety-protection device.

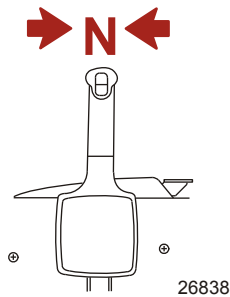

Remote Steering Notice

The steering link rod that connects the steering cable to the engine must be fastened utilizing self-locking nuts. These self-locking nuts must never be replaced with common nuts (non-locking) as they will work loose and vibrate off, freeing the link rod to disengage.

GENERAL INFORMATION

⚠ WARNING

Improper fasteners or improper installation procedures can result in loosening or disengagement of the steering link rod. This can cause a sudden, unexpected loss of boat control, resulting in serious injury or death due to occupants being thrown within or out of the boat. Always use required components and follow instructions and torque procedures.

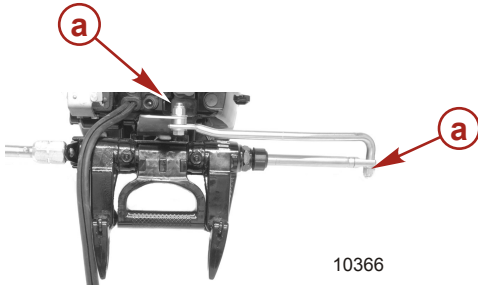

a - Self-locking nuts

10366

Lanyard Stop Switch

The purpose of a lanyard stop switch is to turn off the engine when the operator moves far enough away from the operator's position (as in accidental ejection from the operator's position) to activate the switch. Tiller handle outboards and some remote control units are equipped with a lanyard stop switch. A lanyard stop switch can be installed as an accessory - generally on the dashboard or side adjacent to the operator's position.

GENERAL INFORMATION

The lanyard is a cord usually 122–152 cm (4–5 feet) in length when stretched out, with an element on one end made to be inserted into the switch and a snap on the other end for attaching to the operator. The lanyard is coiled to make its at-rest condition as short as possible to minimize the likelihood of lanyard entanglement with nearby objects. Its stretched-out length is made to minimize the likelihood of accidental activation should the operator choose to move around in an area close to the normal operator's position. If it is desired to have a shorter lanyard, wrap the lanyard around the operator's wrist or leg, or tie a knot in the lanyard.

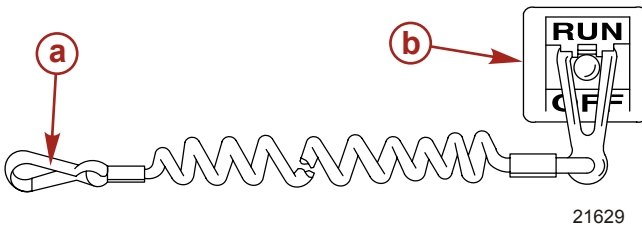

- a** - Lanyard cord
- b** - Lanyard stop switch

Read the following Safety Information before proceeding.

GENERAL INFORMATION

Important Safety Information: The purpose of a lanyard stop switch is to stop the engine when the operator moves far enough away from the operator's position to activate the switch. This would occur if the operator accidentally falls overboard or moves within the boat a sufficient distance from the operator's position. Falling overboard and accidental ejections are more likely to occur in certain types of boats such as low sided inflatables, bass boats, high performance boats, and light, sensitive handling fishing boats operated by a hand tiller. Falling overboard and accidental ejections are also likely to occur as a result of poor operating practices such as sitting on the back of the seat or gunwale at planing speeds, standing at planing speeds, sitting on elevated fishing boat decks, operating at planing speeds in shallow or obstacle infested waters, releasing your grip on a steering wheel or tiller handle that is pulling in one direction, drinking alcohol or consuming drugs, or daring high speed boat maneuvers.

While activation of the lanyard stop switch will stop the engine immediately, a boat will continue to coast for some distance depending upon the velocity and degree of any turn at shut down. However, the boat will not complete a full circle. While the boat is coasting, it can cause injury to anyone in the boat's path as seriously as the boat would when under power.

We strongly recommend that other occupants be instructed on proper starting and operating procedures should they be required to operate the engine in an emergency (if the operator is accidentally ejected).

WARNING

If the operator falls out of the boat, stop the engine immediately to reduce the possibility of serious injury or death from being struck by the boat. Always properly connect the operator to the stop switch using a lanyard.

GENERAL INFORMATION

WARNING

Avoid serious injury or death from deceleration forces resulting from accidental or unintended stop switch activation. The boat operator should never leave the operator's station without first disconnecting the stop switch lanyard from the operator.

Accidental or unintended activation of the switch during normal operation is also a possibility. This could cause any, or all, of the following potentially hazardous situations:

- Occupants could be thrown forward due to unexpected loss of forward motion - a particular concern for passengers in the front of the boat who could be ejected over the bow and possibly struck by the gearcase or propeller.
- Loss of power and directional control in heavy seas, strong current, or high winds.
- Loss of control when docking.

KEEP THE LANYARD STOP SWITCH AND LANYARD CORD IN GOOD OPERATING CONDITION

Before each use, check to ensure the lanyard stop switch works properly. Start the engine and stop it by pulling the lanyard cord. If the engine does not stop, have the switch repaired before operating the boat.

Before each use, visually inspect the lanyard cord to ensure it is in good working condition and that there are no breaks, cuts, or wear to the cord. Check that the clips on the ends of the cord are in good condition. Replace any damaged or worn lanyard cords.

GENERAL INFORMATION

Protecting People in the Water

WHILE YOU ARE CRUISING

It is very difficult for a person standing or floating in the water to take quick action to avoid a boat heading in his/her direction, even at slow speed.



Always slow down and exercise extreme caution any time you are boating in an area where there might be people in the water. Whenever a boat is moving (coasting) and the outboard gear shift is in neutral position, there is sufficient force by the water on the propeller to cause the propeller to rotate. This neutral propeller rotation can cause serious injury.

WHILE THE BOAT IS STATIONARY

WARNING

A spinning propeller, a moving boat, or any solid device attached to the boat can cause serious injury or death to swimmers. Stop the engine immediately whenever anyone in the water is near your boat.

Shift the outboard into neutral and shut off the engine before allowing people to swim or be in the water near your boat.

GENERAL INFORMATION

Passenger Safety Message - Pontoon Boats and Deck Boats

Whenever the boat is in motion, observe the location of all passengers. Do not allow any passengers to stand or use seats other than those designated for traveling faster than idle speed. A sudden reduction in boat speed, such as plunging into a large wave or wake, a sudden throttle reduction, or a sharp change of boat direction, could throw them over the front of the boat. Falling over the front of the boat between the two pontoons will position them to be run over by the outboard.

BOATS HAVING AN OPEN FRONT DECK

No one should ever be on the deck in front of the fence while the boat is in motion. Keep all passengers behind the front fence or enclosure.

Persons on the front deck could easily be thrown overboard or persons dangling their feet over the front edge could get their legs caught by a wave and pulled into the water.

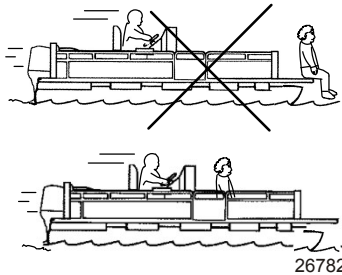

WARNING

Sitting or standing in an area of the boat not designed for passengers at speeds above idle can cause serious injury or death. Stay back from the front end of deck boats or raised platforms and remain seated while the boat is in motion.

GENERAL INFORMATION

BOATS WITH FRONT MOUNTED, RAISED PEDESTAL FISHING SEATS

Elevated fishing seats are not intended for use when the boat is traveling faster than idle or trolling speed. Sit only in seats designated for traveling at faster speeds.

Any unexpected, sudden reduction in boat speed could result in the elevated passenger falling over the front of the boat.

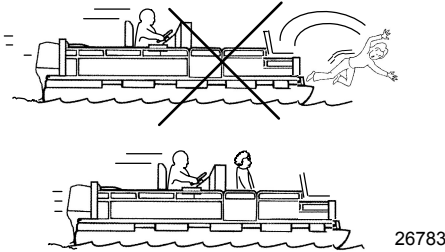

Wave and Wake Jumping

Operating recreational boats over waves and wake is a natural part of boating. However, when this activity is done with sufficient speed to force the boat hull partially or completely out of the water, certain hazards arise, particularly when the boat enters the water.

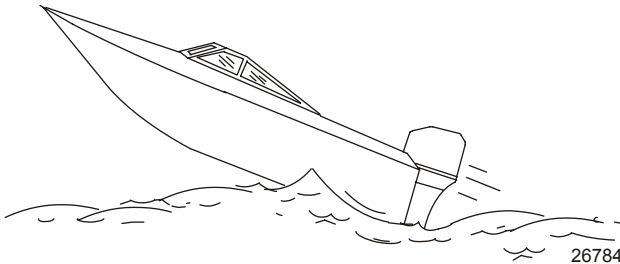

The primary concern is the boat changing direction while in the midst of the jump. In such case, the landing may cause the boat to veer violently in a new direction. Such a sharp change in direction can cause occupants to be thrown out of their seats, or out of the boat.

GENERAL INFORMATION

WARNING

Wave or wake jumping can cause serious injury or death from occupants being thrown within or out of the boat. Avoid wave or wake jumping whenever possible.

There is another less common hazardous result from allowing your boat to launch off a wave or wake. If the bow of your boat pitches down far enough while airborne, upon water contact it may penetrate under the water surface and submarine for an instant. This will bring the boat to a nearly instantaneous stop and can send the occupants flying forward. The boat may also steer sharply to one side.

Impact with Underwater Hazards

Reduce speed and proceed with caution whenever you drive a boat in shallow water areas, or in areas where you suspect underwater obstacles may exist which could be struck by the outboard or the boat bottom. **The most important thing you can do to help reduce injury or impact damage from striking a floating or underwater object is to control the boat speed. Under these conditions, boat speed should be kept to a minimum planing speed of 24 to 40 km/h (15 to 25 mph).**

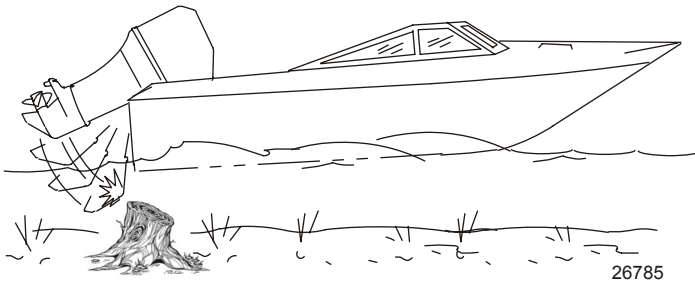

Striking a floating or underwater object could result in an infinite number of situations. Some of these situations could result in the following:

- Part of the outboard or the entire outboard could break loose and fly into the boat.

GENERAL INFORMATION

- The boat could move suddenly in a new direction. Such a sharp change in direction can cause occupants to be thrown out of their seats or out of the boat.
- A rapid reduction in speed. This will cause occupants to be thrown forward, or even out of the boat.
- Impact damage to the outboard and/or boat.

Keep in mind, the most important thing you can do to help reduce injury or impact damage during an impact is control the boat speed. Boat speed should be kept to a minimum planing speed when driving in waters known to have underwater obstacles.

After striking a submerged object, stop the engine as soon as possible and inspect it for any broken or loose parts. If damage is present or suspected, the outboard should be taken to an authorized dealer for a thorough inspection and necessary repair.

The boat should also be checked for any hull fractures, transom fractures, or water leaks.

Operating a damaged outboard could cause additional damage to other parts of the outboard, or could affect control of the boat. If continued running is necessary, do so at greatly reduced speeds.

WARNING

Operating a boat or engine with impact damage can result in product damage, serious injury, or death. If the vessel experiences any form of impact, have an authorized Mercury Marine dealer inspect and repair the vessel or power package.

SAFETY INSTRUCTIONS FOR HAND-TILLED OUTBOARDS

No person or cargo should occupy the area directly in front of the outboard while the boat is in motion. If an underwater obstacle is struck, the outboard will tilt up and could seriously injure anyone occupying this area.

GENERAL INFORMATION

Models with Clamp Screws:

Some outboards come with transom bracket clamp screws. The use of clamp bracket screws alone, is insufficient to properly and safely secure the outboard to the transom. Proper installation of the outboard includes bolting the engine to the boat through the transom. Refer to **Installation - Installing Outboard** for more complete installation information.

WARNING

Failure to correctly fasten the outboard could result in the outboard propelling off the boat transom resulting in property damage, serious injury, or death. Before operation, the outboard must be correctly installed with the required mounting hardware.

If an obstacle is struck at planing speed and the outboard is not securely fastened to the transom, it is possible the outboard could lift off the transom and land in the boat.

Exhaust Emissions

BE ALERT TO CARBON MONOXIDE POISONING

Carbon monoxide (CO) is a deadly gas that is present in the exhaust fumes of all internal combustion engines, including the engines that propel boats, and the generators that power boat accessories. By itself, CO is odorless, colorless, and tasteless, but if you can smell or taste engine exhaust, you are inhaling CO.

Early symptoms of carbon monoxide poisoning, which are similar to the symptoms of seasickness and intoxication, include headache, dizziness, drowsiness, and nausea.

GENERAL INFORMATION

WARNING

Inhaling engine exhaust gases can result in carbon monoxide poisoning, which can lead to unconsciousness, brain damage, or death. Avoid exposure to carbon monoxide.

Stay clear from exhaust areas when engine is running. Keep the boat well-ventilated while at rest or underway.

STAY CLEAR OF EXHAUST AREAS

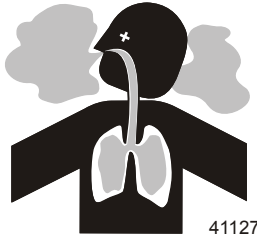

Engine exhaust gases contain harmful carbon monoxide. Avoid areas of concentrated engine exhaust gases. When engines are running, keep swimmers away from the boat, and do not sit, lie, or stand on swim platforms or boarding ladders. While underway, do not allow passengers to be positioned immediately behind the boat (platform dragging, teak/body surfing). This dangerous practice not only places a person in an area of high engine exhaust concentration, but also subjects them to the possibility of injury from the boat propeller.

GOOD VENTILATION

Ventilate the passenger area, open side curtains or forward hatches to remove fumes.

Example of desired air flow through the boat:

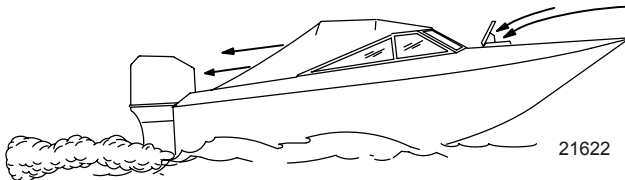

GENERAL INFORMATION

POOR VENTILATION

Under certain running and/or wind conditions, permanently enclosed or canvas enclosed cabins or cockpits with insufficient ventilation may draw in carbon monoxide. Install one or more carbon monoxide detectors in your boat.

Although the occurrence is rare, on a very calm day, swimmers and passengers in an open area of a stationary boat that contains, or is near, a running engine may be exposed to a hazardous level of carbon monoxide.

1. Examples of poor ventilation while the boat is stationary:

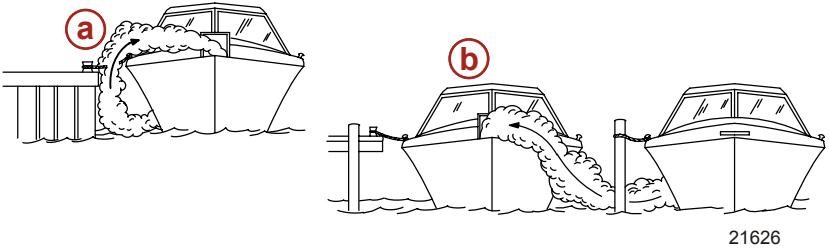

- a** - Operating the engine when the boat is moored in a confined space
- b** - Mooring close to another boat that has its engine operating

2. Examples of poor ventilation while the boat is moving:



- a** - Operating the boat with the trim angle of the bow too high
- b** - Operating the boat with no forward hatches open (station wagon effect)

GENERAL INFORMATION

Selecting Accessories for Your Outboard

Genuine Mercury Precision or Quicksilver Accessories have been specifically designed and tested for your outboard. These accessories are available from Mercury Marine dealers.

IMPORTANT: Check with your dealer before installing accessories. The misuse of approved accessories or the use of nonapproved accessories can damage the product.

Some accessories not manufactured or sold by Mercury Marine are not designed to be safely used with your outboard or outboard operating system. Acquire and read the installation, operation and maintenance manuals for all your selected accessories.

Safe Boating Recommendations

To safely enjoy the waterways, familiarize yourself with local and all other governmental boating regulations and restrictions and consider the following suggestions.

Know and obey all nautical rules and laws of the waterways.

- We recommend that all powerboat operators complete a boating safety course. In the U.S., the U.S. Coast Guard Auxiliary, the Power Squadron, the Red Cross, and your state or provincial boating law enforcement agency provide courses. For more information in the U.S., call the Boat U.S. Foundation at 1-800-336-BOAT (2628).

Perform safety checks and required maintenance.

- Follow a regular schedule and ensure that all repairs are properly made.

Check safety equipment onboard.

- Here are some suggestions of the types of safety equipment to carry when boating:
 - Approved fire extinguishers
 - Signal devices: flashlight, rockets or flares, flag, and whistle or horn
 - Tools necessary for minor repairs
 - Anchor and extra anchor line

GENERAL INFORMATION

- Manual bilge pump and extra drain plugs
- Drinking water
- Radio
- Paddle or oar
- Spare propeller, thrust hubs, and an appropriate wrench
- First aid kit and instructions
- Waterproof storage containers
- Spare operating equipment, batteries, bulbs, and fuses
- Compass and map or chart of the area
- Personal flotation device (one per person onboard)

Watch for signs of weather change and avoid foul weather and rough-sea boating.

Tell someone where you are going and when you expect to return.

Passenger boarding.

- Stop the engine whenever passengers are boarding, unloading, or are near the back (stern) of the boat. Shifting the drive unit into neutral is not sufficient.

Use personal flotation devices.

- Federal law requires that there be a U.S. Coast Guard-approved life jacket (personal flotation device), correctly sized and readily accessible for every person onboard, plus a throwable cushion or ring. We strongly advise that everyone wear a life jacket at all times while in the boat.

Prepare other boat operators.

- Instruct at least one person onboard in the basics of starting and operating the engine and boat handling in case the driver becomes disabled or falls overboard.

Do not overload your boat.

GENERAL INFORMATION

- Most boats are rated and certified for maximum load (weight) capacities (refer to your boat's capacity plate). Know your boat's operating and loading limitations. Know if your boat will float if it is full of water. When in doubt, contact your authorized Mercury Marine dealer or the boat manufacturer.

Ensure that everyone in the boat is properly seated.

- Do not allow anyone to sit or ride on any part of the boat that was not intended for such use. This includes the backs of seats, gunwales, transom, bow, decks, raised fishing seats, and any rotating fishing seat. Passengers should not sit or ride anywhere that sudden unexpected acceleration, sudden stopping, unexpected loss of boat control, or sudden boat movement could cause a person to be thrown overboard or into the boat. Ensure that all passengers have a proper seat and are in it before any boat movement.

Never operate a boat while under the influence of alcohol or drugs. It is the law.

- Alcohol or drugs can impair your judgment and greatly reduce your ability to react quickly.

Know your boating area and avoid hazardous locations.

Be alert.

- The operator of the boat is responsible by law to maintain a proper lookout by sight and hearing. The operator must have an unobstructed view particularly to the front. No passengers, load, or fishing seats should block the operator's view when the boat is above idle or planing transition speed. Watch out for others, the water, and your wake.

Never drive your boat directly behind a water skier.

- Your boat traveling at 40 km/h (25 mph) will overtake a fallen skier who is 61 m (200 ft) in front of you in five seconds.

Watch fallen skiers.

GENERAL INFORMATION

- When using your boat for waterskiing or similar activities, always keep a fallen or down skier on the operator's side of the boat while returning to attend to the skier. The operator should always have the down skier in sight and never back up to the skier or anyone in the water.

Report accidents.

- Boat operators are required by law to file a boating accident report with their state boating law enforcement agency when their boat is involved in certain boating accidents. A boating accident must be reported if 1) there is loss of life or probable loss of life, 2) there is personal injury requiring medical treatment beyond first aid, 3) there is damage to boats or other property where the damage value exceeds \$500.00, or 4) there is complete loss of the boat. Seek further assistance from local law enforcement.

Recording Serial Number

It is important to record this number for future reference. The serial number is located on the outboard as shown.

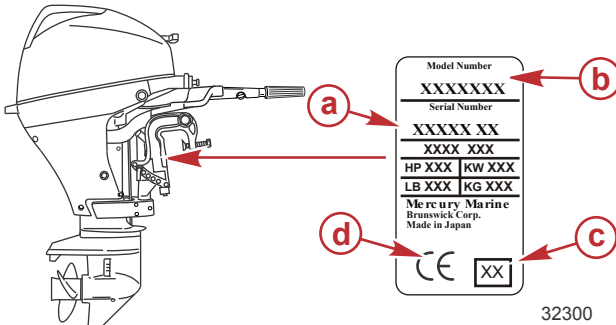

- a** - Serial number
- b** - Model designation
- c** - Year manufactured
- d** - Certified Europe Insignia (as applicable)

GENERAL INFORMATION

Specifications

Models	15/15 ProKicker	20
Power	11.0 kw (15 hp)	14.7 kw (20 hp)
Full throttle RPM range	5000–6000 RPM	5400–6100 RPM
Idle speed in forward gear	950 ± 50 RPM	
Number of cylinders	2	
Piston displacement	351 cc (21.4 cid)	
Cylinder bore	61.0 mm (2.40 in.)	
Stroke	60 mm (2.36 in.)	
Valve clearance (cold)		
Intake valve	0.13–0.17 mm (0.005–0.007 in.)	
Exhaust valve	0.18–0.22 mm (0.007–0.008 in.)	
Recommended spark plug	NGK DCPR6E	
Spark plug gap	0.8–0.9 mm (0.031–0.035 in.)	
Gear ratio	2.15:1	
Recommended gasoline	Refer to Fuel and Oil	
Recommended oil	Refer to Fuel and Oil	
Gearcase lubricant capacity	370 ml (12.5 fl oz)	
Engine oil capacity	1.0 liter (1.1 US qt)	
Emission control system	Engine modification (EM)	
Sound at drivers ear (ICOMIA 39-94) dBA	84.6	
Tiller handle vibration (ICOMIA 38-94) m/s ²	7.6	

TRANSPORTING

Carrying, Storing, and Transporting Your Outboard when Removed from Boat

IMPORTANT: Ensure the proper procedures are followed for transportation and storage of the outboard to avoid the possibility of oil leaks.

1. With the outboard still in the water, disconnect the remote fuel line and run the engine until it stops. This will drain fuel from the carburetor. Install the protector cap over the fuel connector.

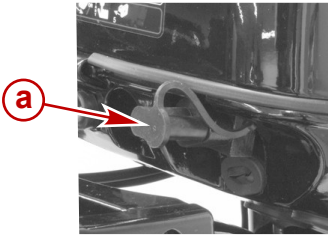

a - Protector cap

32122

2. Remove the outboard and hold it upright until the water is drained out.
3. Carry, transport, or store the outboard in any of the three positions shown. These positions will prevent oil from draining out of the crankcase.

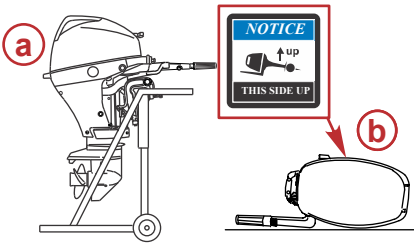

- a** - Upright position
b - Tiller handle down
c - Front side down

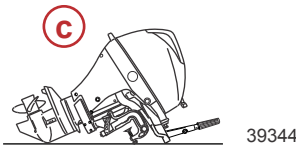

39344

TRANSPORTING

Transporting Portable Fuel Tanks

WARNING

Avoid serious injury or death from a gasoline fire or explosion. Follow the transporting instructions supplied with the portable fuel tank. Transport the fuel tank in a well ventilated area away from open flame or sparks.

MANUAL VENTING TYPE FUEL TANK

Close the fuel tank air vent when transporting tank. This will prevent escape of fuel or vapors from tank.

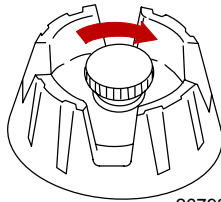

26793

AUTO-VENTING TYPE FUEL TANK

1. Disconnect the remote fuel line from tank. This will close the air vent and prevent escape of fuel or vapors from tank.
2. Install tether cap over the fuel line connector stem. This will protect the connector stem from being accidentally pushed-in, allowing fuel or vapor to escape.

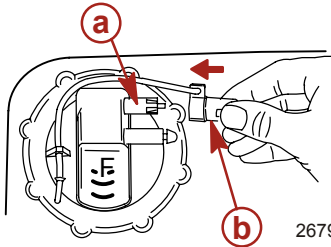

26794

a - Connector stem

b - Tether cap

Trailing Boat/Outboard

Trailer your boat with the outboard tilted down in a vertical operating position.

TRANSPORTING

If additional ground clearance is required, the outboard should be tilted up using an accessory outboard support device. Refer to your local dealer for recommendations. Additional clearance may be required for railroad crossings, driveways, and trailer bouncing.

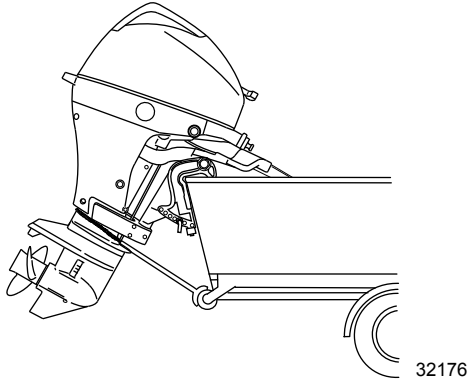

IMPORTANT: Do not rely on the power tilt system or the tilt support lever to maintain proper ground clearance for trailering. The outboard tilt support lever is not intended to support the outboard for trailering.

Shift the outboard to forward gear. This prevents the propeller from spinning freely.

FUEL AND OIL

Fuel Recommendations

IMPORTANT: Use of improper gasoline can damage your engine. Engine damage resulting from the use of improper gasoline is considered misuse of the engine, and damage caused thereby will not be covered under the limited warranty.

FUEL RATINGS

Mercury Marine engines will operate satisfactorily when using a major brand of unleaded gasoline meeting the following specifications:

USA and Canada - having a posted pump octane rating of 87 (R+M)/2 minimum. Premium gasoline (92 [R+M]/2 octane) is also acceptable. Do not use leaded gasoline.

Outside USA and Canada - having a posted pump octane rating of 90 RON minimum. Premium gasoline (98 RON) is also acceptable. If unleaded gasoline is not available, use a major brand of leaded gasoline.

USING REFORMULATED (OXYGENATED) GASOLINES (USA ONLY)

This type of gasoline is required in certain areas of the USA. The two types of oxygenates used in these fuels are alcohol (ethanol) or ether (MTBE or ETBE). If ethanol is the oxygenate that is used in the gasoline in your area, refer to **Gasolines Containing Alcohol**.

These reformulated gasolines are acceptable for use in your Mercury Marine engine.

GASOLINES CONTAINING ALCOHOL

If the gasoline in your area contains either methanol (methyl alcohol) or ethanol (ethyl alcohol), you should be aware of certain adverse effects that can occur. These adverse effects are more severe with methanol. Increasing the percentage of alcohol in the fuel can also worsen these adverse effects.

Some of these adverse effects are caused because the alcohol in the gasoline can absorb moisture from the air, resulting in a separation of the water/alcohol from the gasoline in the fuel tank.

FUEL AND OIL

The fuel system components on your Mercury Marine engine will withstand up to 10% alcohol content in the gasoline. We do not know what percentage your boat's fuel system will withstand. Contact your boat manufacturer for specific recommendations on the boat's fuel system components (fuel tanks, fuel lines, and fittings). Be aware that gasolines containing alcohol may cause increased:

- Corrosion of metal parts
- Deterioration of rubber or plastic parts
- Fuel permeation through rubber fuel lines
- Starting and operating difficulties

WARNING

Fuel leakage is a fire or explosion hazard, which can cause serious injury or death. Periodically inspect all fuel system components for leaks, softening, hardening, swelling, or corrosion, particularly after storage. Any sign of leakage or deterioration requires replacement before further engine operation.

Because of possible adverse effects of alcohol in gasoline, it is recommended that only alcohol-free gasoline be used where possible. If only fuel containing alcohol is available, or if the presence of alcohol is unknown, increased inspection frequency for leaks and abnormalities is required.

IMPORTANT: When operating a Mercury Marine engine on gasoline containing alcohol, storage of gasoline in the fuel tank for long periods should be avoided. Long periods of storage, common to boats, create unique problems. In cars, alcohol-blend fuels normally are consumed before they can absorb enough moisture to cause trouble, but boats often sit idle long enough for phase separation to take place. In addition, internal corrosion may take place during storage if alcohol has washed protective oil films from internal components.

Low Permeation Fuel Hose Requirement

Required for outboards manufactured for sale, sold, or offered for sale in the United States.

FUEL AND OIL

- The Environmental Protection Agency (EPA) requires that any outboard manufactured after January 1, 2009, must use low permeation fuel hose for the primary fuel hose connecting the fuel tank to the outboard.
- Low permeation hose is USCG Type B1-15 or Type A1-15, defined as not exceeding 15/gm²/24 h with CE 10 fuel at 23 °C as specified in SAE J 1527 - marine fuel hose.

EPA Pressurized Portable Fuel Tank Requirements

The Environmental Protection Agency (EPA) requires portable fuel systems that are produced after January 1, 2011, for use with outboard engines to remain fully sealed (pressurized) up to 34.4 kPa (5.0 psi). These tanks may contain the following:

- An air inlet that opens to allow air to enter as the fuel is drawn out of the tank.
- An air outlet that opens (vents) to the atmosphere if pressure exceeds 34.4 kPa (5.0 psi).

Fuel Demand Valve (FDV) Requirement

Whenever a pressurized fuel tank is used, a fuel demand valve is required to be installed in the fuel hose between the fuel tank and primer bulb. The fuel demand valve prevents pressurized fuel from entering the engine and causing a fuel system overflow or possible fuel spillage.

The fuel demand valve has a manual release. The manual release can be used (pushed in) to open (bypass) the valve in case of a fuel blockage in the valve.



- a** - Fuel demand valve - installed in the fuel hose between the fuel tank and primer bulb
- b** - Manual release
- c** - Vent/water drain holes

FUEL AND OIL

Mercury Marine's Pressurized Portable Fuel Tank

Mercury Marine has created a new portable pressurized fuel tank that meets the preceding EPA requirements. These fuel tanks are available as an accessory or are provided with certain portable outboard models.

SPECIAL FEATURES OF THE PORTABLE FUEL TANK

- The fuel tank has a two-way valve which allows air to enter the tank as the fuel is drawn to the engine, and also opens to vent to the atmosphere if internal pressure in the tank exceeds 34.4 kPa (5.0 psi). A hissing noise may be heard as the tank vents to the atmosphere. This is normal.
- The fuel tank includes a fuel demand valve that prevents pressurized fuel from entering the engine and causing a fuel system overflow or possible fuel spillage.
- When installing the fuel tank cap, turn the cap to the right until you hear a click. This signals that the fuel cap is fully seated. A built-in device prevents overtightening.
- The fuel tank has a manual vent screw which should be closed for transportation and open for operation and cap removal.

Since sealed fuel tanks are not vented, they will expand and contract as the fuel expands and contracts during heating and cooling cycles of the outside air. This is normal.

REMOVING THE FUEL CAP

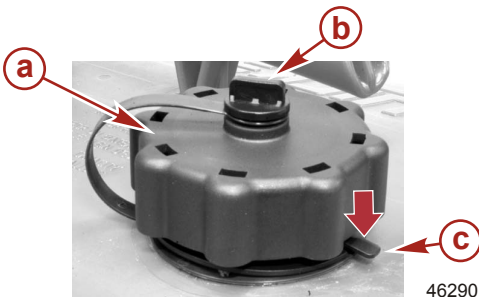

- a** - Fuel cap
- b** - Manual vent screw
- c** - Tab lock

IMPORTANT: Contents may be under pressure. Rotate the fuel cap 1/4 turn to relieve pressure before opening.

1. Open the manual vent screw on top of the fuel cap.

FUEL AND OIL

2. Turn the fuel cap until it contacts the tab lock.
3. Press down on the tab lock. Rotate the fuel cap 1/4 turn to relieve the pressure.
4. Press down on the tab lock again and remove the cap.

DIRECTIONS FOR USING THE PRESSURIZED PORTABLE FUEL TANK

1. When installing the fuel tank cap, turn the cap to the right until you hear a click. This signals that the fuel cap is fully seated. A built-in device prevents overtightening.
2. Open the manual vent screw on top of the cap for operation and cap removal. Close the manual vent screw for transportation.
3. For fuel hoses that have quick disconnects, disconnect the fuel line from the engine or fuel tank when not in use.
4. Follow **Filling Fuel Tank** instructions for fueling.

Filling Fuel Tank

WARNING

Avoid serious injury or death from a gasoline fire or explosion. Use caution when filling fuel tanks. Always stop the engine and do not smoke or allow open flames or sparks in the area while filling fuel tanks.

Fill the fuel tanks outdoors away from heat, sparks, and open flames.

Remove the portable fuel tanks from the boat to fill them.

Always stop the engine before filling the tanks.

Do not completely fill the fuel tanks. Leave approximately 10% of the tank volume unfilled. Fuel will expand in volume as its temperature rises and can leak under pressure if the tank is completely filled.

PORTABLE FUEL TANK PLACEMENT IN THE BOAT

Place the fuel tank in the boat so the vent is higher than the fuel level under normal boat operating conditions.

FUEL AND OIL

Engine Oil Recommendations

We recommend the use of Mercury or Quicksilver NMMA FC-W certified 10W-30 4-Stroke Outboard Oil for general, all-temperature use. If NMMA certified synthetic blend 25W-40 4-Stroke outboard oil is preferred, use Mercury or Quicksilver synthetic blend 4-Stroke Outboard Oil. If the recommended Mercury or Quicksilver NMMA FC-W certified outboard oils are not available, a major FC-W certified 4-stroke outboard oil may be used.

IMPORTANT: The use of detergent oils, multi-viscosity oils (other than Mercury or Quicksilver NMMA FC-W certified oil or a major brand NMMA FC-W certified oil), synthetic oils, low quality or oils that contain solid additives are not recommended.

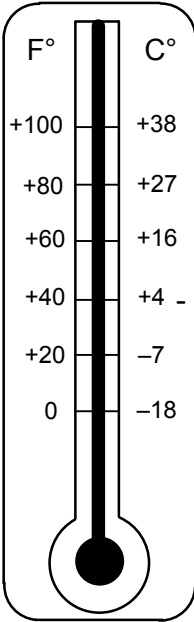

Recommended SAE viscosity for engine oil

- a** - NMMA FC-W certified 25W-40 4-stroke outboard oil may be used at temperatures above 4 °C (40 °F)
- b** - NMMA FC-W certified 10W-30 4-stroke outboard oil is recommended for use in all temperatures.

Checking Engine Oil

IMPORTANT: Do not overfill. For accurate readings, check oil only when engine is cold or after engine has not run for at least an hour.

1. Tilt the outboard to vertical operating position.

FUEL AND OIL

2. Remove the top cowl. Refer to **Maintenance - Cowl Removal and Installation**.
3. Pull out the dipstick. Wipe the dipstick end with a clean rag or towel and push it back in all the way.
4. Pull the dipstick back out again and observe the oil level. Oil should be in the operating range between the upper and lower hole.

IMPORTANT: Do not try to fill the oil level to the top of the operating range (upper hole). Oil level is correct as long as it appears in the operating range between the upper and lower hole.

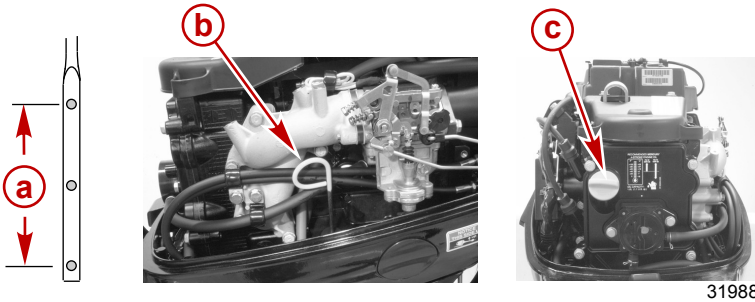

- a** - Oil level operating range
- b** - Dipstick
- c** - Oil fill cap

5. If the oil level is below the operating range (lower hole), remove the oil fill cap and add approximately 200 ml (7 oz.) of specified outboard motor oil. Allow a few minutes for the added oil to drain to the oil sump and check the dipstick. Repeat the process until oil level is in the operating range between the upper and lower holes. Do not try to fill to the upper end of the operation range (upper hole).

FUEL AND OIL

NOTE: Under certain conditions, the operating temperature of 4-stroke outboard engines may not get hot enough to evaporate the normal fuel and moisture that accumulate in the crankcase. These conditions include operating at idle for long periods, repeated short trips, slow speed or quick stop-and-go operation, and operating in cooler climates. This additional fuel and moisture that collects in the crankcase eventually ends up in the oil sump and will add to the total volume of oil that appears on the dipstick reading. This increase in oil volume is known as oil dilution. Outboard engines can typically handle large amounts of oil dilution without causing durability problems. However, to ensure extended life of the outboard engine, Mercury recommends that the oil and filter be changed regularly following the oil change interval and using the recommended oil quality. It is further recommended that if your outboard is operated frequently in the conditions described above, that more frequent oil change intervals be considered.

6. Push the dipstick back in all the way.
7. Install the oil fill cap hand-tight.
8. Install top cowl.

FEATURES AND CONTROLS

Tiller Handle Features

- Tiller handle - Handle can be tilted 180° for convenient handling during transportation and storage.

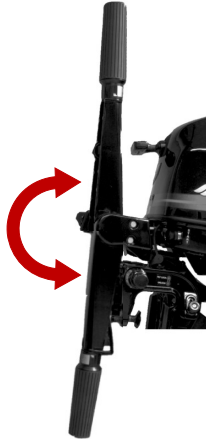

28535

- Tiller lock release lever - Push lever to move tiller handle from one position to another.

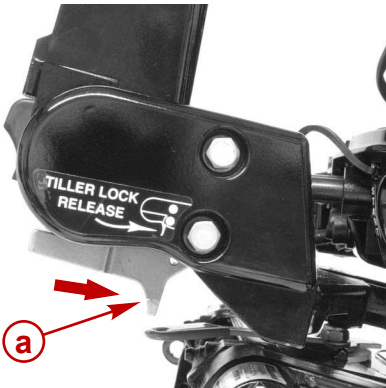

a - Tiller lock release lever

3274

FEATURES AND CONTROLS

- Tiller handle lock cap - Remove and retain the lock cap on the top of the tiller handle to lock in the up position. Push the tiller lock release lever to release the handle from the locked up position. Install the lock cap to prevent the tiller handle from locking in the up position.

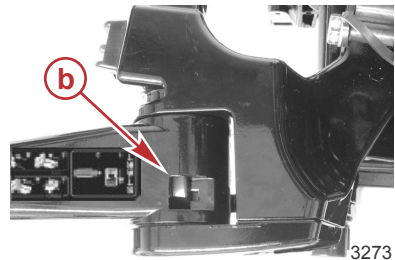
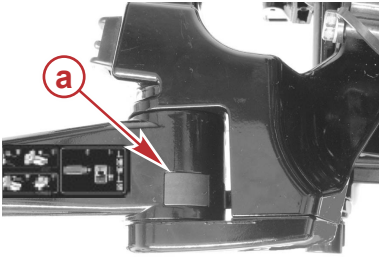

- a** - Lock cap
- b** - Locking mechanism

- Lanyard stop switch - Refer to **General Information - Lanyard Stop Switch**.

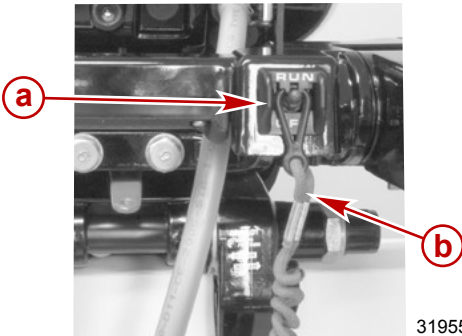

- a** - Lanyard stop switch
- b** - Lanyard

- Engine stop switch - Push in to stop the engine.



FEATURES AND CONTROLS

- Power tilt switch - Push to tilt the engine up/down.



- Throttle grip friction knob - Turn the friction knob to set and maintain the throttle at desired speed. Turn the knob clockwise to tighten friction or turn the knob counterclockwise to loosen friction.

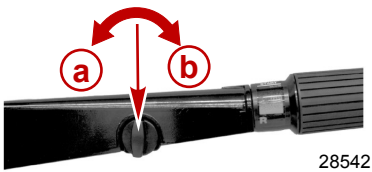

- a** - Loosen friction (counterclockwise)
- b** - Tighten friction (clockwise)

- Throttle only button - Pressing the button in while the outboard is in neutral disables the gear shift control of the tiller handle.

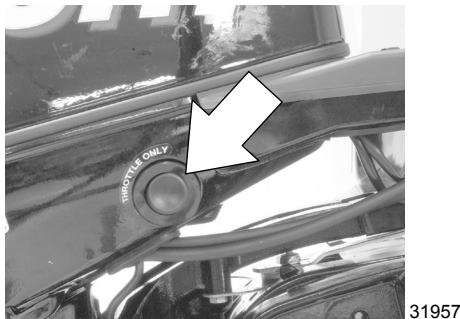

FEATURES AND CONTROLS

- Throttle grip - Controls engine speed and shifting. The outboard has three gear shift positions to provide operation: forward (F), neutral (N), and reverse (R).



- Choke/fast idle - Pull out when starting a cold engine.
- Fuel primer - Press in when starting a cold engine. Refer to **Operation - Starting the Engine**.
- Low oil pressure warning light - Warns the operator the engine has low oil pressure. When the low oil pressure light is on or is blinking, the engine will run rough and will not exceed 3000 RPM.
- Electric start button (electric start models) - Press button to start engine.

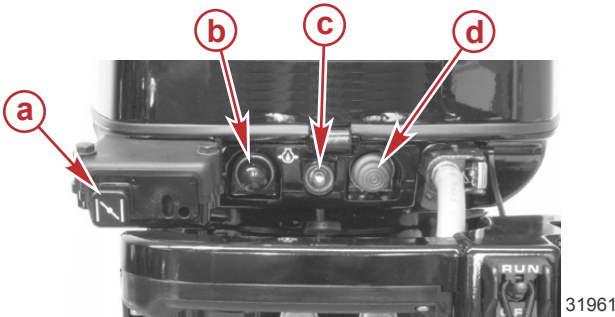

- a** - Choke/fast idle
- b** - Fuel primer
- c** - Low oil pressure warning light
- d** - Electric start button (electric start models)

FEATURES AND CONTROLS

Remote Control Features

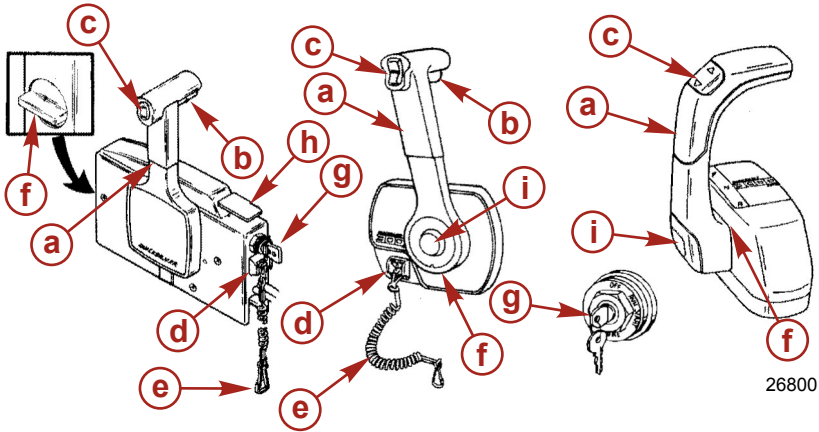

- a** - Control handle - forward, neutral, reverse
- b** - Neutral release lever
- c** - Power tilt switch (if equipped) - Refer to **Features and Controls - Power Tilt Features and Operation**
- d** - Lanyard stop switch - Refer to **General Information - Lanyard Stop Switch**
- e** - Lanyard - Refer to **General Information - Lanyard Stop Switch**
- f** - Throttle friction adjustment - Console controls require cover removal for adjustment
- g** - Ignition key switch - "OFF," "ON," "START"
- h** - Throttle only lever - Refer to **Operation - Starting the Engine**
- i** - Throttle only button - Refer to **Operation - Starting the Engine**

General Features

- Steering friction adjustment - Adjust this lever to achieve the desired steering friction (drag) on the tiller handle or steering wheel. Move the lever to the left to tighten, or move the lever to the right to loosen.

FEATURES AND CONTROLS

⚠ WARNING

Insufficient friction adjustment can cause serious injury or death due to loss of boat control. When setting the friction adjustment, maintain sufficient steering friction to prevent the outboard from steering into a full turn if the tiller handle or steering wheel is released.

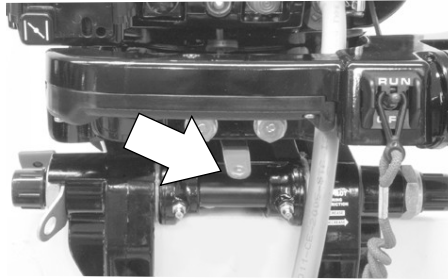

31965



Tiller handle models

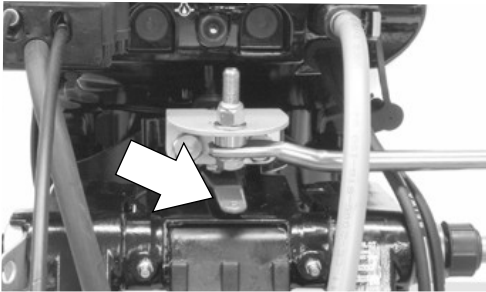

32190



Remote control models

a - Tighten

b - Loosen

FEATURES AND CONTROLS

- Fuel connector protector cap - Place over the fuel connector when the fuel hose is disconnected.

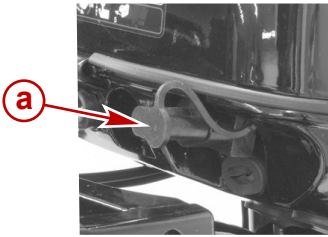

a - Fuel connector protector cap

32122

- Cooling water intakes - The outboard has two water intakes for cooling the engine, the primary water intake and the secondary water intake.

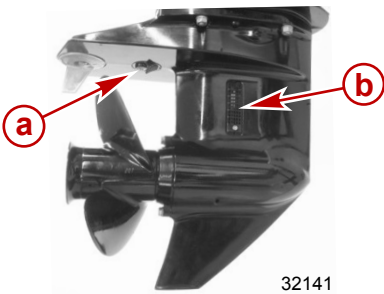

a - Secondary water intake
b - Primary water intake

32141

- Water pump indicator hole - Water spray from the hole indicates the water pump is pumping cooling water up to the engine.



31982

Manual Tilt Features and Operation

- Tilt lever - Allows the outboard to be locked into the shallow water drive position or the full up position. Refer to **Basic Tilting Operation**.

FEATURES AND CONTROLS

- Tilt pin - Set the vertical operating angle on the outboard. Refer to **Setting the Operation Angle of the Outboard**.

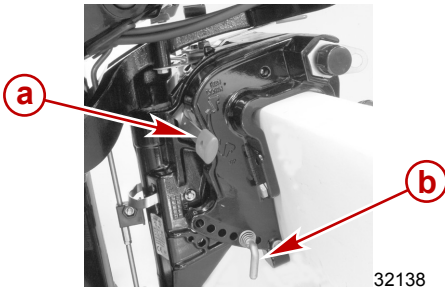

- a** - Tilt lever
- b** - Tilt pin

BASIC TILTING OPERATION

The tilt feature allows the operator to tilt the outboard to a higher tilt angle for operation in shallow water, or tilt the outboard to the full up position.

When running the outboard, keep the tilt lever in the release position. This allows the outboard to return to the running position if the outboard should hit an underwater obstacle and be lifted up.

Moving the tilt lever to the tilt position will allow the outboard to lock into the shallow water drive position or the full up position.

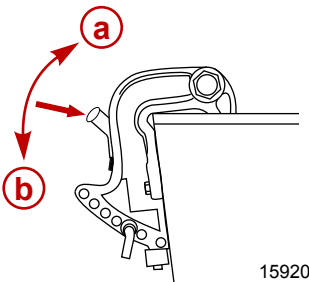

- a** - Release position
- b** - Tilt position

TILTING OUTBOARD TO FULL UP POSITION

1. Stop the engine.
2. Shift the outboard to forward gear position.
3. Position the tilt lever to the tilt position.

FEATURES AND CONTROLS

4. Take hold of the top cowl grip and tilt the outboard all the way up until it locks in place.

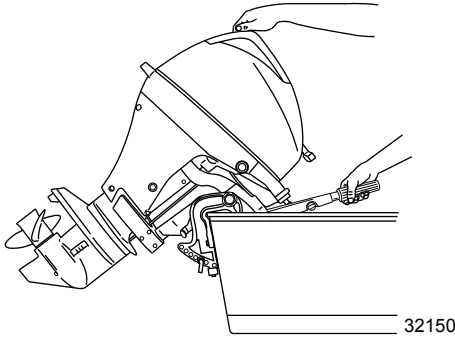

LOWERING OUTBOARD DOWN TO RUN POSITION

Position the tilt lever to the release position. Raise the outboard slightly to release it from its locked position and gently lower it.

SHALLOW WATER OPERATION

The shallow water drive position on the outboard allows you to position the outboard at a higher tilt angle to prevent hitting bottom.

IMPORTANT: Before tilting the outboard into the shallow water drive position, reduce the engine speed to idle and shift the engine into forward gear.

IMPORTANT: While in the shallow water drive position, do not operate the outboard in reverse. Operate the outboard at slow speed and keep the cooling water intake submerged.

1. Reduce the engine speed to idle.
2. Shift the engine into forward gear position.
3. Position the tilt lever to the tilt position.
4. Take hold of the top cowl grip and tilt up the outboard until it locks in the shallow water running position.

FEATURES AND CONTROLS

5. To release the outboard out of shallow water drive, position the tilt lever to the release position, slightly lift up the outboard, and gently lower it down.

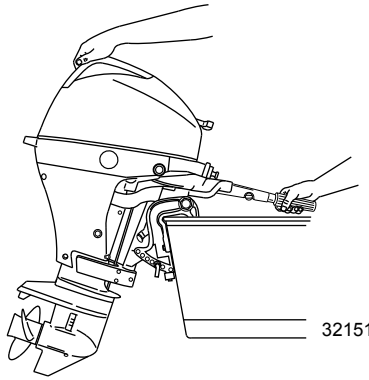

SETTING THE OPERATION ANGLE OF THE OUTBOARD

The vertical operating angle of your outboard is adjusted by changing the position of the tilt pin in the six adjustment holes provided. Proper adjustment allows the boat to run stable, achieve optimum performance, and minimize steering effort.

NOTE: Refer to the following lists when adjusting the operating angle of your outboard.

The tilt pin should be adjusted so the outboard is positioned to run perpendicular to the water when the boat is running at full speed. This allows the boat to be driven parallel to the water.

FEATURES AND CONTROLS

Arrange passengers and load in the boat so the weight is distributed evenly.

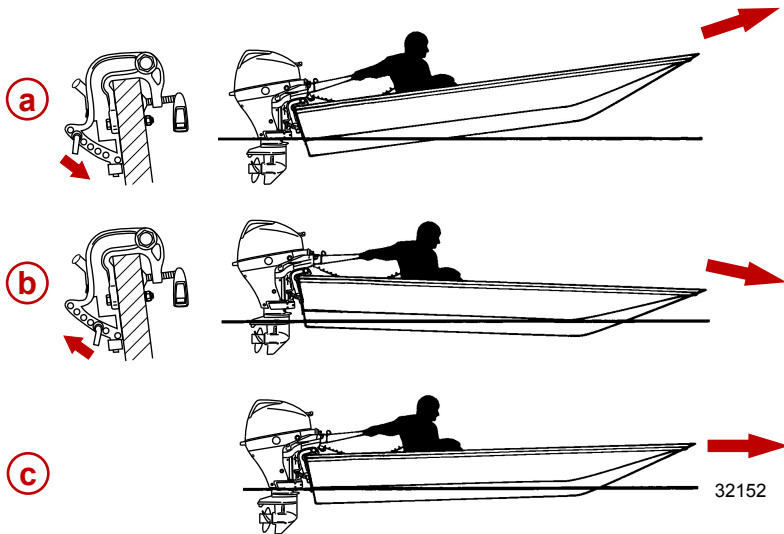

- a** - Too much angle (stern down - bow up)
- b** - Not enough angle (stern up - bow down)
- c** - Angle adjusted properly (bow slightly up)

Consider the following lists carefully when adjusting the operating angle of your outboard.

Adjusting the outboard close to the boat transom can:

- Lower the bow
- Result in quicker planing off, especially with a heavy load or a stern heavy boat
- Generally improve the ride in choppy water
- Increase steering torque or pull to the right (with the normal right hand rotation propeller)
- In excess, can lower the bow of some boats to a point where they begin to plow with their bow in the water while on plane. This can result in an unexpected turn in either direction (called bow steering or over-steering) if any turn is attempted, or if a significant wave is encountered.

FEATURES AND CONTROLS

Adjusting the outboard away from the boat transom can:

- Lift the bow out of the water
- Generally increase top speed
- Increase clearance over submerged objects or a shallow bottom
- Increase steering torque or pull to the left at a normal installation height (with the normal right hand rotation propeller)
- In excess, can cause boat porpoising (bouncing) or propeller ventilation

Power Tilt Features and Operation

POWER TILT

Models equipped with power tilt allows the operator to use the tilt switch to adjust the tilt position of the outboard from full down to full up.

This tilt system is designed to be adjusted when the engine speed is at idle speed or with the engine turned off.

At low idle speed, the outboard can be tilted up to permit shallow water operation.

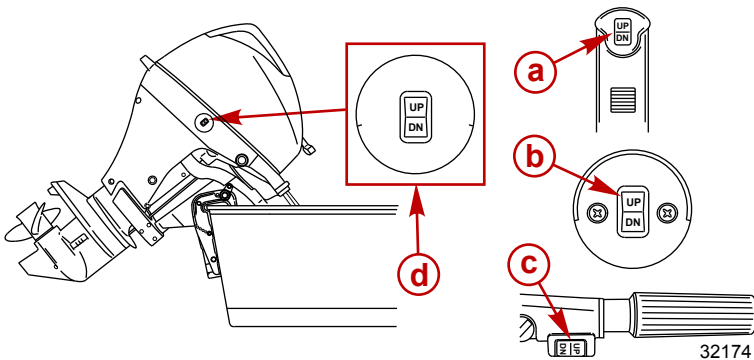

- a** - Remote control tilt switch
- b** - Panel mount tilt switch
- c** - Tiller handle tilt switch
- d** - Cowl mounted tilt switch

FEATURES AND CONTROLS

TILTING THE OUTBOARD TO FULL UP POSITION

To tilt the outboard, shut off the engine and press the tilt switch to the up position. The outboard will tilt up until the switch is released or it reaches its maximum tilt position.

1. Engage the tilt support lever by rotating the lever down.
2. Lower the outboard to rest on the tilt support lever.
3. Disengage the tilt support lever by slightly tilting up the outboard and releasing the tilt support bracket. Lower the outboard.

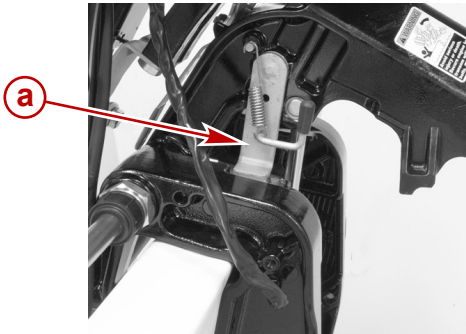

a - Tilt support lever

31919

PROKICKER CENTERING STRAPS FEATURE

ProKicker centering straps (if equipped) will center the outboard and prevent the outboard from turning while the outboard is tilted up.

The ProKicker centering straps will prevent the outboard from turning when tilted up. If using a steering tie bar to a second outboard, disconnect the steering tie bar to allow steering of the second outboard.

FEATURES AND CONTROLS

WARNING

Avoid injury or death from loss of steering control. ProKicker centering straps prevent the outboard from turning when tilted up. If using a steering tie bar to a second outboard, disconnect the steering tie bar to allow steering of the second outboard before operating the boat.

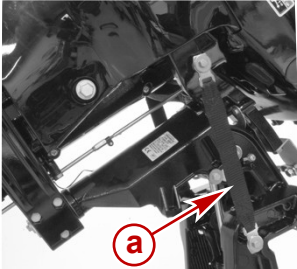

a - ProKicker centering straps

32201

SHALLOW WATER OPERATION

When operating your boat in shallow water, the outboard can be tilted up to a higher tilt angle. Reduce engine speed to idle for tilting. Operate the outboard at slow speed while tilted up for shallow water operation. Keep the cooling water intake holes submerged in the water and continue to check for water discharge from the water pump indicator hole.

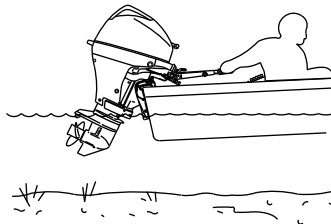

32193

MANUAL TILT RELEASE

If the outboard cannot be tilted using the power tilt switch, the outboard can be manually tilted.

NOTE: *The manual tilt release valve must be tightened before operating the outboard to prevent the outboard from tilting up during reverse operation.*

FEATURES AND CONTROLS

Turn out the manual tilt release valve three turns counterclockwise. This allows manual tilting of the outboard. Tilt the outboard to the desired position and tighten the manual tilt release valve.



TILT-IN STOP ADJUSTMENT

NOTE: *The outboard should be positioned against the tilt-in stop pins during operation.*

The adjustment of the tilt-in stop pins will set the vertical operating angle of your outboard. Proper adjustment allows the boat to run stable, achieve optimum performance, and minimize steering effort.

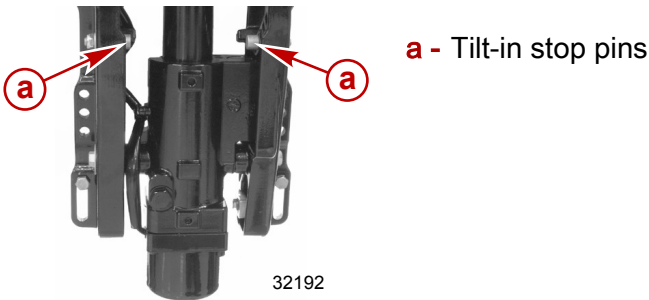

NOTE: *Refer to the following lists when adjusting the operating angle of your outboard.*

The tilt-in stop pins should be adjusted so the outboard is positioned to run perpendicular to the water when the boat is running at full speed. This allows the boat to be driven parallel to the water.

FEATURES AND CONTROLS

Arrange passengers and load in the boat so the weight is distributed evenly.

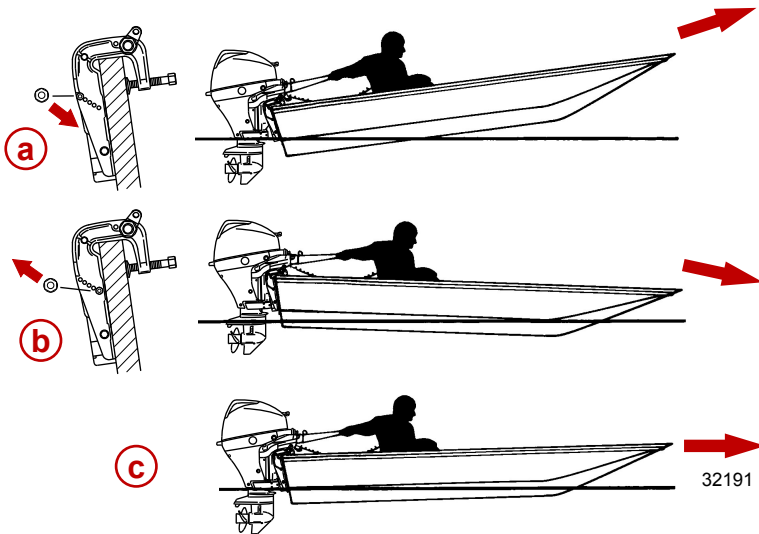

- a** - Too much angle (stern down - bow up)
- b** - Not enough angle (stern up - bow down)
- c** - Angle adjusted properly (bow slightly up)

Consider the following lists carefully when adjusting the operating angle of your outboard.

Adjusting the outboard close to the boat transom can:

- Lower the bow
- Result in quicker planing off, especially with a heavy load or a stern heavy boat
- Generally improve the ride in choppy water
- Increase steering torque or pull to the right (with the normal right hand rotation propeller)
- In excess, can lower the bow of some boats to a point where they begin to plow with their bow in the water while on plane. This can result in an unexpected turn in either direction (called bow steering or over-steering) if any turn is attempted, or if a significant wave is encountered.

FEATURES AND CONTROLS

Adjusting the outboard away from the boat transom can:

- Lift the bow out of the water
- Generally increase top speed
- Increase clearance over submerged objects or a shallow bottom
- Increase steering torque or pull to the left at a normal installation height (with the normal right hand rotation propeller)
- In excess, can cause boat porpoising (bouncing) or propeller ventilation

Warning System Features and Operation

LOW OIL PRESSURE WARNING SYSTEM TEST

At engine start-up, the low oil pressure warning light will turn on for 10 seconds as a normal system test.

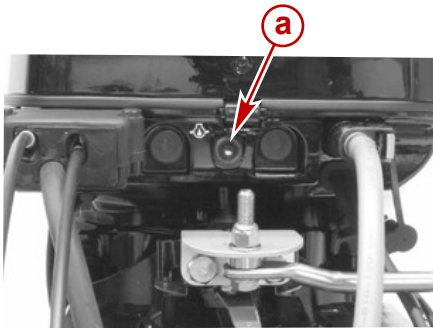

32189

a - Low oil pressure warning light

LOW OIL PRESSURE

The low oil pressure warning light will turn on if the oil pressure drops too low. First, stop the engine and check the oil level. Add oil if necessary. If the oil is at the recommended level and the warning horn stays on, consult your dealer. Engine speed will be limited to 2100 RPM, however, you should not continue to run the engine.

FEATURES AND CONTROLS

ENGINE OVERHEAT

Check for a steady stream flowing out of the water pump indicator hole. If no water is coming out of the water pump indicator hole or flow is intermittent, stop engine and check cooling water intake holes for obstruction. If no obstruction is found, this may indicate a blockage in the cooling system or a water pump problem. Have the outboard checked by your dealer. Operating the engine while overheated will cause engine damage.

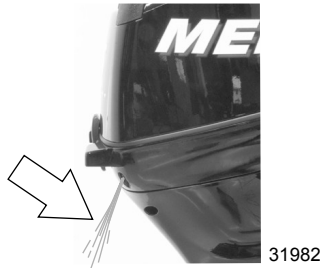

NOTE: *Should overheating occur and you are stranded, stop the engine and allow it to cool down. This will usually allow some additional low speed (idle) running time before the engine starts to overheat again.*

ENGINE OVERSPEED LIMITER

If engine speed exceeds 6400 RPM, the overspeed limiter will be activated. The engine timing will be momentarily retarded to prevent operation above this limit.

Some causes of engine overspeed are as follows:

- Propeller ventilation
- A propeller which has an incorrect pitch or diameter
- Propeller hub slippage
- Outboard mounted too high on the transom
- Tilting the outboard out beyond a vertical position
- Cavitation of the propeller due to rough water or obstruction in the boat hull

FEATURES AND CONTROLS

Trim Tab Adjustment

Propeller steering torque will cause the boat to pull in one direction. Steering torque results from the outboard not being tilted so the propeller shaft is parallel to the water surface. The trim tab can help compensate for this steering torque in many cases and can be adjusted within limits to reduce any unequal steering effort.

Operate your boat at normal cruising speed with the outboard set at the desired operating angle position. Turn your boat left and right and note the direction the boat turns more easily.

If adjustment is necessary, loosen the trim tab bolt and make small adjustments at a time. If the boat turns more easily to the left, move the trailing edge of trim tab to the left. If the boat turns more easily to the right, move the trailing edge of trim tab to the right. Tighten the bolt and retest.

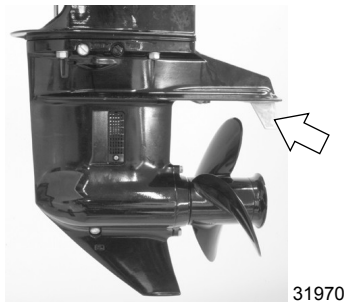

OPERATION

Prestarting Check List

- Operator knows safe navigation, boating, and operating procedures.
- An approved personal flotation device of suitable size for each person aboard and readily accessible (it is the law).
- A ring type life buoy or buoyant cushion designed to be thrown to a person in the water.
- Know your boats' maximum load capacity. Look at the boat capacity plate.
- Fuel supply OK.
- Arrange passengers and load in the boat so the weight is distributed evenly and everyone is seated in a proper seat.
- Tell someone where you are going and when you expect to return.
- It is illegal to operate a boat while under the influence of alcohol or drugs.
- Know the waters and area you will be boating; tides, currents, sand bars, rocks, and other hazards.
- Make inspection checks listed in **Maintenance - Inspection and Maintenance Schedule**.

Operating in Freezing Temperatures

When using your outboard or having your outboard moored in freezing or near freezing temperatures, keep the outboard tilted down at all times so the gearcase is submerged. This prevents the trapped water in the gearcase from freezing and causing possible damage to the water pump and other components.

If there is a chance of ice forming on the water, the outboard should be removed and drained completely of water. If ice should form at the water level inside the outboard driveshaft housing, it will block water flow to the engine causing possible damage.

OPERATION

Operating in Saltwater or Polluted Water

We recommend that you flush the internal water passages of your outboard with fresh water after each use in salt or polluted water. This will prevent a buildup of deposits from clogging the water passages. Refer to **Maintenance - Flushing the Cooling System**.

If you keep your boat moored in the water, always tilt the outboard so the gearcase is completely out of water (except in freezing temperatures) when not in use.

Wash the outboard exterior and flush out the exhaust outlet of the propeller and gearcase with fresh water after each use. Each month, spray Mercury Precision or Quicksilver Corrosion Guard on external metal surfaces. Do not spray on corrosion control anodes as this will reduce the effectiveness of the anodes.

Operating Outboard as an Auxiliary Engine

If the outboard is used as an auxiliary engine, stop the engine and tilt the outboard out of the water when using the main power source.

IMPORTANT: The outboard must be restrained from bouncing while operating the boat using the main power source. Bouncing can damage the outboard and boat transom.

Pre-Starting Instructions

1. Connect the remote fuel line to the outboard. Make sure the connector is snapped into place.

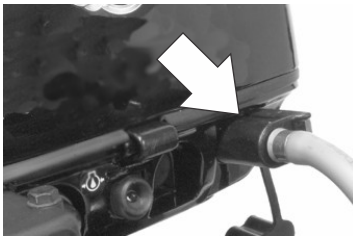

31976

OPERATION

2. Check the engine oil level.

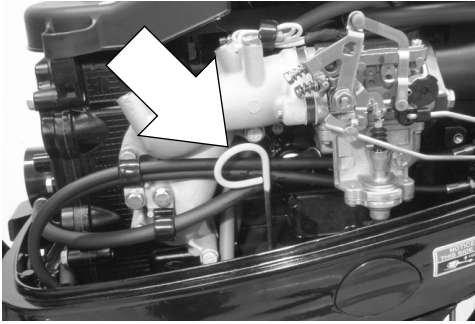

31977

NOTICE

Without sufficient cooling water, the engine, the water pump, and other components will overheat and suffer damage. Provide a sufficient supply of water to the water inlets during operation.

3. Make sure the cooling water intake is submerged.

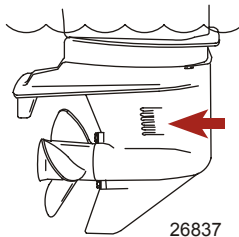

26837

4. Tiller handle models with manual or electric start, have a quick reference decal on the tiller handle that shows the sequence for starting the engine. Use this quick reference for cold or hot starting.



52379

Tiller handle starting sequence decal

OPERATION

Engine Break-in Procedure

IMPORTANT: Failure to follow the engine break-in procedures can result in poor performance throughout the life of the engine and can cause engine damage. Always follow break-in procedures.

1. For the first hour of operation, run the engine at varied throttle settings up to 2000 RPM or at approximately half throttle.
2. For the second hour of operation, run the engine at varied throttle settings up to 3000 RPM or at three-quarter throttle, and at full throttle for approximately one minute every ten minutes.
3. For the next eight hours of operation, avoid continuous operation at full throttle for more than five minutes at a time.

Starting the Engine - Tiller Handle Models

Before starting, read the **Pre-Starting Check List**, **Pre-Starting Instructions**, and **Engine Break-in Procedure** in the **Operation** section.

1. Open the fuel tank vent screw on manual venting type tanks.

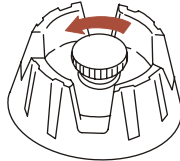

19748

2. Position the fuel line primer bulb so the arrow on the side of the bulb is pointing up. Squeeze the fuel line primer bulb several times until it feels firm.

IMPORTANT: To prevent engine flooding, do not squeeze the primer bulb after the engine has warmed up.

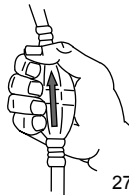

27348

OPERATION

3. Set the lanyard stop switch to the "RUN" position. Refer to **General Information - Lanyard Stop Switch**.



19791

4. Set the tiller handle gear shift to the neutral ("N") position.



5. **Cold engine** - If the engine is cold, press the fuel primer in twice and pull out the choke/fast idle knob for starting. Push in the choke/fast idle knob after engine starts to warm up.

NOTE: For initial start of a new engine or first start after a prolonged storage, the primer lines may have air in them. In this case, depress the fuel primer ten times rapidly.

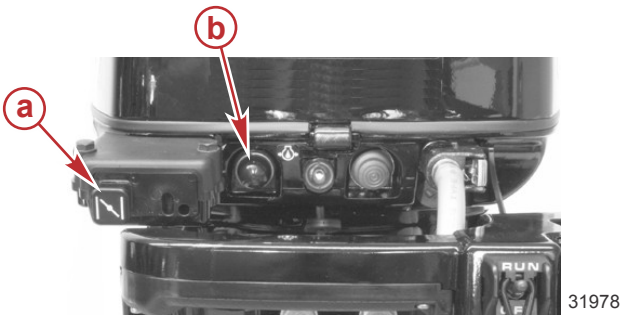

a - Choke/fast idle knob

b - Fuel primer

OPERATION

IMPORTANT: Avoid engine flooding - Do not press in the fuel primer if engine is warm. This will inject fuel into the engine and may cause a hard starting flooded condition.

IMPORTANT: Outboards with battery charging capabilities must not be operated with the battery cables disconnected from the battery. Damage to the charging system may result.

6. **Manual starting models** - Pull the starter rope slowly until you feel the starter engage, then pull rapidly to crank the engine. Allow rope to return slowly. Repeat until engine starts. After the engine has started, push in the choke/fast idle knob.

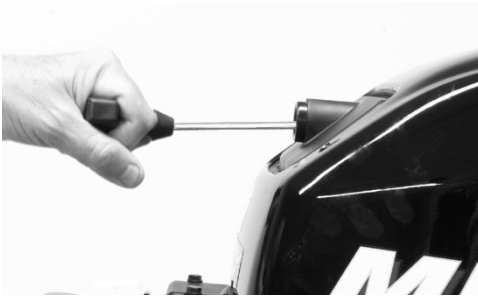

31954

7. **Electric starting models** - Push the starter button and crank the engine. Release button when the engine starts. Do not operate the starter motor continuously for longer than ten seconds at a time. If the engine fails to start, wait 30 seconds and try again.

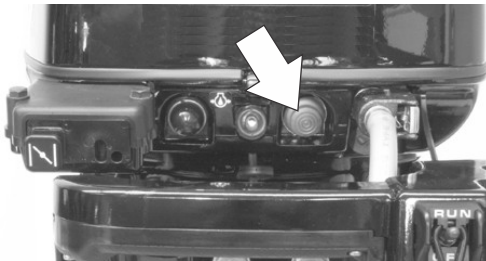

31979

OPERATION

- Flooded engine** - If the engine will not start, push in the throttle only button and advance the throttle grip to fast throttle speed. Push in the choke knob and start the engine. After the engine has started, immediately reduce throttle speed to idle.

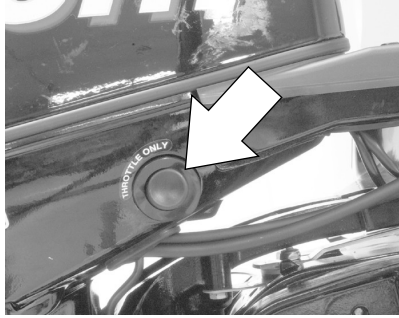

31957

- Check for the low oil pressure warning light to turn off. The low oil pressure warning light will turn on for ten seconds after the outboard starts as a normal system test. If the light should stay on, refer to **Features and Controls - Warning System**.

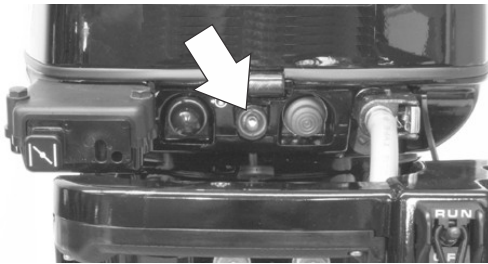

32208

OPERATION

10. Check for a steady stream of water flowing out of the water pump indicator hole.

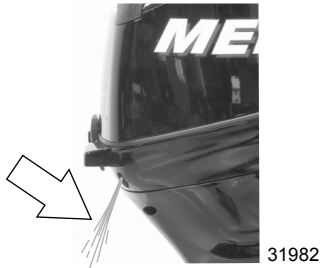

IMPORTANT: If no water is coming out of the water pump indicator hole, stop the engine and check the cooling water intake for obstruction. No obstruction may indicate a water pump failure or blockage in the cooling system. These conditions will cause the engine to overheat. Have the outboard checked by your dealer. Operating the engine while overheated will cause serious engine damage.

WARMING UP ENGINE

Before beginning operation, allow the engine to warm up at idling speed for three minutes.

Starting the Engine - Remote Control Models

Before starting, read the **Pre-Starting Check List**, **Pre-Starting Instructions**, and **Engine Break-in Procedure** in the **Operation** section.

1. Open the fuel tank vent screw in the filler cap on manual venting type tanks.

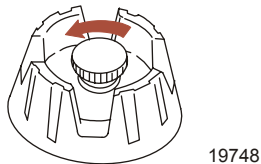

2. Position the fuel line primer bulb so the arrow on the side of the bulb is pointing up. Squeeze the fuel line primer bulb several times until it feels firm.

OPERATION

IMPORTANT: To prevent engine flooding, do not squeeze the primer bulb after the engine has warmed up.

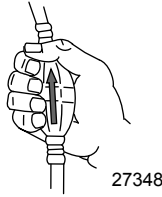

3. Set the lanyard stop switch to the "RUN" position. Refer to **General Information - Lanyard Stop Switch**.

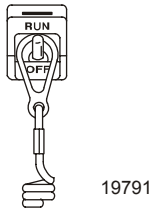

4. Set the remote control handle to the neutral position.
IMPORTANT: Avoid engine flooding - Do not advance the throttle while engine is not running. This will inject fuel into the engine and may cause a hard starting flooded condition.

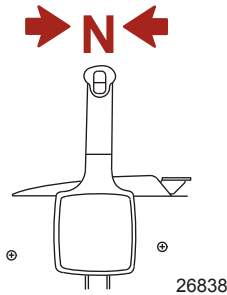

IMPORTANT: Outboards with battery charging capabilities must not be operated with battery cables disconnected from the battery. Damage to the charging system may result.

OPERATION

5. **Temperatures above 0 °C (32 °F)** - Do not use the throttle only feature on the remote control for initial starting. After starting the engine, you can slowly advance the throttle only feature, to increase idle speed until the engine is warmed up. Keep engine speed below 2000 RPM.

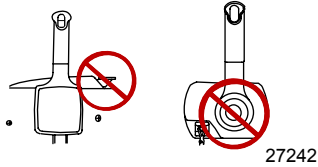

6. **Temperatures below 0 °C (32 °F)** - Use the throttle only feature on the remote control to open the throttle slightly for initial starting. After starting the engine, you can slowly advance the throttle only feature, to increase idle speed until the engine is warmed up. Keep engine speed below 2000 RPM.

NOTE: *If the engine fails to start after five attempts, pump the throttle twice by moving the throttle only feature to the full open position two times. Return the throttle only feature back so that the throttle is only opened slightly and retry starting the engine.*

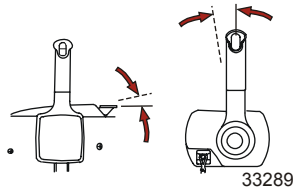

NOTE: *Starting flooded engine - Advance the throttle only feature and continue to crank the engine for starting.*

OPERATION

7. Turn the ignition key to the "START" position and start the engine. If the engine is cold, push in on the key to choke the engine while cranking. If the engine fails to start in ten seconds, wait 30 seconds and try again. If the engine begins to stall, choke (push the key in) until the engine is running smoothly.

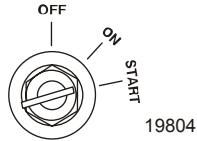

8. Check for the low oil pressure warning light to turn off. The low oil pressure warning light will turn on for ten seconds after the outboard starts as a normal system test. If the light should stay on, refer to **Features and Controls - Warning System**.

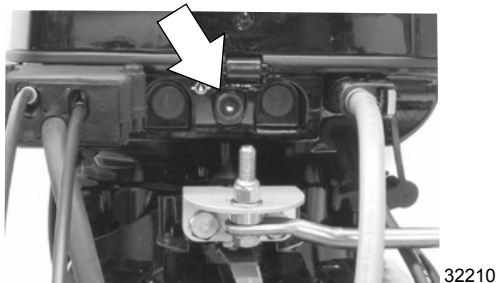

9. Check for a steady stream of water flowing out of the water pump indicator hole.

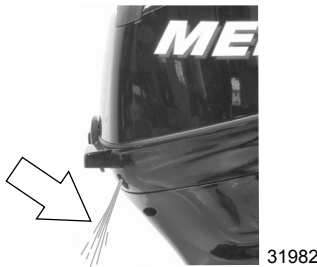

OPERATION

IMPORTANT: If no water is coming out of the water pump indicator hole, stop the engine and check the cooling water intake for obstruction. No obstruction may indicate a water pump failure or blockage in the cooling system. These conditions will cause the engine to overheat. Have the outboard checked by your dealer. Operating the engine while overheated will cause serious engine damage.

WARMING UP ENGINE

Before beginning operation, allow the engine to warm up at idling speed for three minutes.

Gear Shifting

IMPORTANT: Never shift the outboard into gear unless engine speed is at idle. Do not shift the outboard into reverse when the engine is not running.

- **Tiller handle models** - Your outboard has three gear shift positions to provide operation: forward (F), neutral (N), and reverse (R). When shifting, always stop at neutral position and allow the engine speed to return to idle.
- **Remote control models** - Your outboard has three gear shift positions to provide operation: forward (F), neutral (N), and reverse (R). When shifting, always stop at neutral position and allow the engine speed to return to idle.

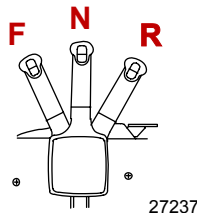

OPERATION

- Always shift the outboard into gear with a quick motion.
- After shifting the outboard into gear, advance the remote control lever or rotate the throttle grip (tiller handle) to increase speed.

Stopping the Engine

1. **Remote control models** - Reduce the engine speed and shift the outboard to the neutral position. Turn the ignition key to the "OFF" position.

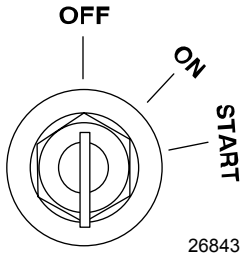

2. **Tiller handle models** - Reduce the engine speed and shift the outboard to the neutral position. Push in the engine stop button.

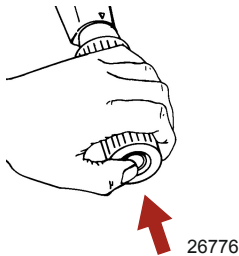

OPERATION

Emergency Starting

If the starter system fails, use the spare starter rope (provided) and follow this procedure.

⚠ WARNING

The neutral-speed-protection device is inoperative when starting the engine with the emergency starter rope. Set the engine speed at idle and the gear shift in neutral to prevent the outboard from starting in gear.

1. Shift the outboard into neutral.
2. Ensure the lanyard stop switch is in the run position.
3. Remove and retain the hardware securing the rewind starter. Remove the rewind starter and move it to the side.

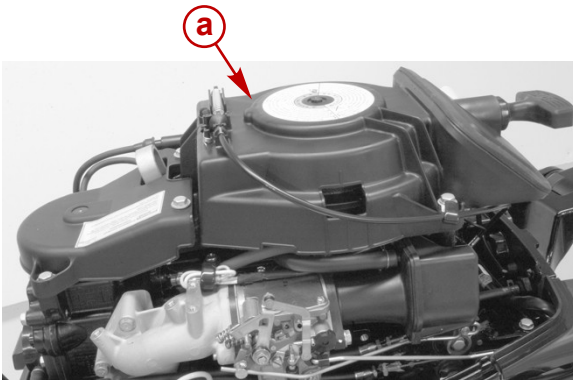

31984

a - Rewind starter

4. Remote control models - Ensure the key switch is in the "ON" position.

⚠ WARNING

High voltage is present when starting or operating the engine. Do not touch any ignition component, wiring, or spark plug lead when starting or operating the engine.

OPERATION

⚠ WARNING

The exposed moving flywheel can cause serious injury. Keep your hands, hair, clothing, tools, and other objects away from engine when starting or running the engine. Do not attempt to reinstall the rewind starter or top cowl when engine is running.

5. Refer to the appropriate starting procedure (cold or hot).
6. Place the starter rope knot into the flywheel notch and wind the rope clockwise around the flywheel.

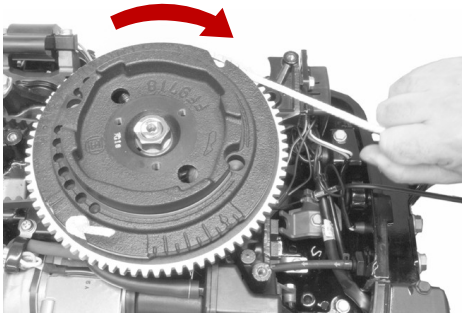

31985

7. Pull the starter rope quickly.

MAINTENANCE

Outboard Care

To keep your outboard in the best operating condition, it is important that your outboard receive the periodic inspections and maintenance listed in the **Inspection and Maintenance Schedule**. We urge you to keep it maintained properly to ensure the safety of you and your passengers, and retain its dependability.

Record maintenance performed in the **Maintenance Log** at the back of this book. Save all maintenance work orders and receipts.

SELECTING REPLACEMENT PARTS FOR YOUR OUTBOARD

We recommend using original Mercury Precision or Quicksilver replacement parts and Genuine Lubricants.

EPA Emission Regulations

All new outboards manufactured by Mercury Marine are certified to the United States Environmental Protection Agency, as conforming to the requirements of the regulations for the control of air pollution from new outboard motors. This certification is contingent on certain adjustments set to factory standards. For this reason, the factory procedure for servicing the product must be strictly followed and, wherever practicable, returned to the original intent of the design. **Maintenance, replacement, or repair of the emission control devices and systems may be performed by any marine spark ignition (SI) engine repair establishment or individual.**

MAINTENANCE

EMISSION CERTIFICATION LABEL

An emission certification label, showing emission levels and engine specifications directly related to emissions, is placed on the engine at time of manufacture.

The diagram shows a rectangular label with a black header and footer. The header contains the text "EMISSION CONTROL INFORMATION". The main body of the label is white and contains the following text: "THIS ENGINE CONFORMS TO [] CALIFORNIA AND U.S. EPA EMISSION REGULATIONS FOR SPARK IGNITION MARINE ENGINES. REFER TO OWNER'S MANUAL FOR REQUIRED MAINTENANCE SPECIFICATIONS AND ADJUSTMENTS. PLEASE PERFORM THE ENGINE MAINTENANCE CORRECTLY." Below this is a table of fields: "DISPLACEMENT: [] FAMILY: []", "FEL: HC+NOx= [] CO= [] HP: []", "LOW-PERM/HIGH-PERM: [] MAXIMUM POWER: []", and "TIMING: [] IDLE SPEED (IN GEAR): []". The footer contains the text "MERCURY MARINE". On the left side, there is a vertical column of months from JAN to JUN, and on the right side, a vertical column from JUL to DEC. At the top left and right corners, there are "20" and a small square box. Red circles with letters a through h are placed around the label, with arrows pointing to specific fields: 'a' points to the Displacement field, 'b' to the FEL field, 'c' to the Low-Perm/High-Perm field, 'd' to the Timing field, 'e' to the Family field, 'f' to the HP field, 'g' to the Maximum Power field, and 'h' to the Idle Speed field.

43058

- a** - Piston displacement
- b** - Maximum emission output for the engine family
- c** - Percent of fuel line permeation
- d** - Timing specification
- e** - Family number
- f** - Engine family description
- g** - Engine power - kilowatts
- h** - Idle speed

OWNER RESPONSIBILITY

The owner/operator is required to have routine engine maintenance performed to maintain emission levels within prescribed certification standards.

The owner/operator is not to modify the engine in any manner that would alter the horsepower or allow emission levels to exceed their predetermined factory specifications.

Inspection and Maintenance Schedule

BEFORE EACH USE

- Check the engine oil level. See **Fuel and Oil - Checking and Adding Engine Oil**.
- Check that lanyard stop switch stops the engine.

MAINTENANCE

- Visually inspect the fuel system for deterioration or leaks.
- Check the outboard for tightness on transom.
- Check the steering system for binding or loose components.
- Remote control models - Visually check the steering link rod fasteners for proper tightness. See **Steering Link Rod Fasteners**.
- Check the propeller blades for damage.

AFTER EACH USE

- Flush out the outboard cooling system if operating in salt or polluted water. See **Flushing the Cooling System**.
- Wash off all salt deposits and flush out the exhaust outlet of the propeller and gearcase with fresh water if operating in saltwater.

EVERY 100 HOURS OF USE OR ONCE YEARLY, WHICHEVER OCCURS FIRST

- Lubricate all lubrication points. Lubricate more frequently when used in saltwater. See **Lubrication Points**.
- Change the engine oil and replace the oil filter. The oil should be changed more often when the engine is operated under adverse conditions such as extended trolling. See **Changing Engine Oil**.
- Replace the spark plugs at first 100 hours or first year. After that, inspect the spark plugs every 100 hours or once yearly. Replace the spark plugs as needed. See **Spark Plug Inspection and Replacement**.
- Inspect thermostat visually for corrosion and broken spring. Make sure thermostat closes completely at room temperature.¹
- Check the fuel line filter for contaminants. See **Fuel System**.
- Check the corrosion control anodes. Check more frequently when used in saltwater. See **Corrosion Control Anode**.
- Check and adjust valve clearance, if necessary.¹
- Drain and replace the gearcase lubricant. See **Gearcase Lubrication**.

1. These items should be serviced by an authorized dealer.

MAINTENANCE

- Check the power tilt fluid. See **Checking Power Tilt Fluid**.
- Lubricate the splines on the driveshaft.¹
- Remote control models - Check the control cable adjustments.¹
- Inspect the timing belt. See **Timing Belt Inspection**.
- Check the tightness of bolts, nuts, and other fasteners.
- Check the cowl seals to make sure seals are intact and not damaged.
- Check the internal cowl sound reduction foam (if equipped) to make sure foam is intact and not damaged.
- Check that the intake silencer (if equipped) is in place.
- Check that the idle relief muffler (if equipped) is in place.
- Check for loose hose clamps and rubber boots (if equipped) on the air intake assembly.

EVERY 300 HOURS OF USE OR THREE YEARS

- Replace the water pump impeller (more often if overheating occurs or reduced water pressure is noted).¹

BEFORE PERIODS OF STORAGE

- Refer to Storage procedure. See **Storage** section.

Flushing the Cooling System

Flush the internal water passages of the outboard with fresh water after each use in salt, polluted, or muddy water. This will help prevent a buildup of deposits from clogging the internal water passages.

Use a Mercury Precision or Quicksilver accessory (or equivalent) flushing attachment.

IMPORTANT: The engine must be run during flushing in order to open the thermostat and circulate water through the water passages.

MAINTENANCE

⚠ WARNING

Rotating propellers can cause serious injury or death. Never operate the boat out of the water with a propeller installed. Before installing or removing a propeller, place the drive unit in neutral and engage the lanyard stop switch to prevent the engine from starting. Place a block of wood between the propeller blade and the anti-ventilation plate.

1. Remove the propeller. Refer to **Propeller Replacement**. Install the flushing attachment so the rubber cups fit tightly over the cooling water intake.

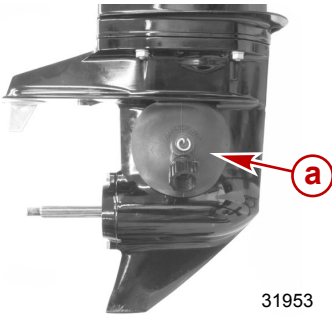

a - Flushing device

Flushing Device	91-44357Q 2
 <p>9192</p>	<p>Attaches to the water intakes; provides a fresh water connection when flushing the cooling system or operating the engine.</p>

MAINTENANCE

2. Attach a water hose to the flushing attachment. Turn on the water and adjust the flow so water is leaking around the rubber cups to ensure the engine receives an adequate supply of cooling water.

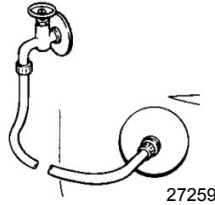

3. Start the engine and run it at idle speed in neutral shift position.

IMPORTANT: Do not run engine above idle when flushing.

4. Adjust water flow (if necessary) so excess water continues leaking out from around the rubber cups to ensure the engine is receiving an adequate supply of cooling water.

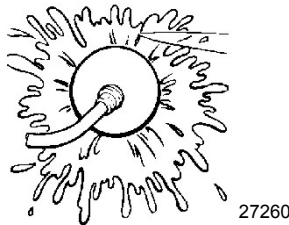

5. Check for a steady stream of water flowing out of the water pump indicator hole. Continue flushing the outboard for 3 to 5 minutes, carefully monitoring water supply at all times.
6. Stop the engine, turn off the water, and remove the flushing attachment. Install the propeller.

Top Cowl Removal and Installation

REMOVAL

1. Release the rear latch.

MAINTENANCE

2. Lift up the rear of the cowl and push it towards the front of the engine to clear the front hook.



INSTALLATION

1. Engage the front hook and position the cowl over the engine.
2. Lock the rear latch.

Battery Inspection

The battery should be inspected at periodic intervals to ensure proper engine starting capability.

IMPORTANT: Read the safety and maintenance instructions which accompany your battery.

1. Turn off the engine before servicing the battery.
2. Ensure the battery is secure against movement.
3. Battery cable terminals should be clean, tight, and correctly installed. Positive to positive and negative to negative.
4. Ensure the battery is equipped with a nonconductive shield to prevent accidental shorting of battery terminals.

Exterior Care

Your outboard is protected with a durable baked enamel finish. Clean and wax often using marine cleaners and waxes.

MAINTENANCE

Fuel System

WARNING

Fuel is flammable and explosive. Ensure that the key switch is off and the lanyard is positioned so that the engine cannot start. Do not smoke or allow sources of spark or open flame in the area while servicing. Keep the work area well ventilated and avoid prolonged exposure to vapors. Always check for leaks before attempting to start the engine, and wipe up any spilled fuel immediately.

Before servicing any part of the fuel system, stop the engine and disconnect the battery. Drain the fuel system completely. Use an approved container to collect and store fuel. Wipe up any spillage immediately. Material used to contain spillage must be disposed of in an approved receptacle. Any fuel system service must be performed in a well-ventilated area. Inspect any completed service work for sign of fuel leakage.

FUEL LINE INSPECTION

Visually inspect the fuel line and primer bulb for cracks, swelling, leaks, hardness, or other signs of deterioration or damage. If any of these conditions are found, the fuel line or primer bulb must be replaced.

FUEL LINE FILTER

Inspect the fuel line filter. If the filter appears to be contaminated, remove and replace.

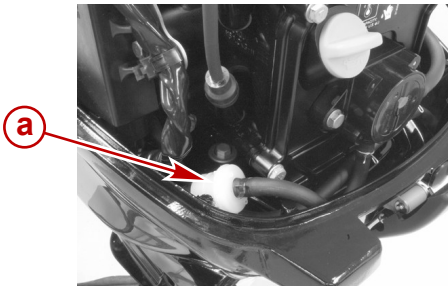

a - Fuel filter

31916

MAINTENANCE

IMPORTANT: Visually inspect for fuel leakage from the filter connections by squeezing the primer bulb until firm, forcing fuel into the filter.

Steering Link Rod Fasteners

IMPORTANT: The steering link rod that connects the steering cable to the engine must be fastened using the steering link rod fastening hardware supplied with engine. Never replace the locknuts (11-16147--3) with common nuts (non-locking) as they will work loose and vibrate off, freeing the link rod to disengage.

WARNING

Improper fasteners or improper installation procedures can result in loosening or disengagement of the steering link rod. This can cause a sudden, unexpected loss of boat control, resulting in serious injury or death due to occupants being thrown within or out of the boat. Always use required components and follow instructions and torque procedures.

Assemble the steering link rod to the steering cable with a flat washer and nylon insert locknut. Tighten locknut until it seats, then back nut off 1/4 turn.

MAINTENANCE

Assemble the steering link rod to the engine with bolt, locknut, spacer, and flat washers. Torque the locknut to specifications.

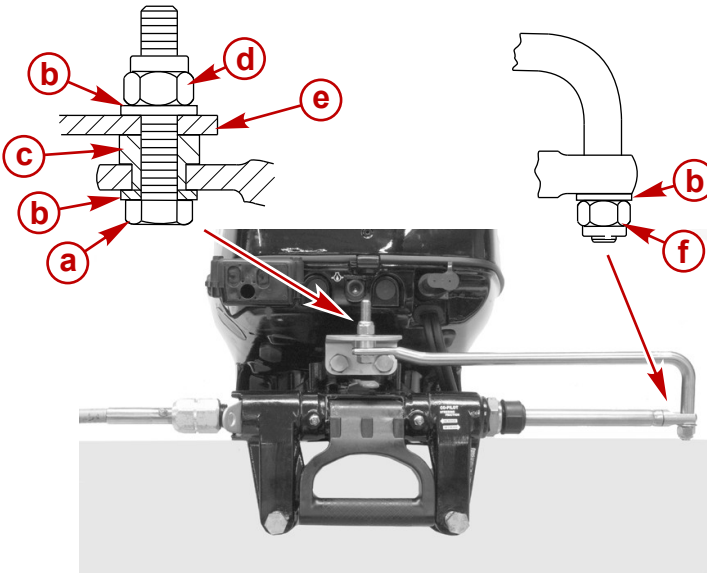

31917

- a** - Bolt (12-71970)
- b** - Flat washer
- c** - Spacer
- d** - Nylon insert locknut (11-16147--3)
- e** - Steering bracket
- f** - Nylon insert locknut (11-16147--3) (tighten until it seats, then back off 1/4 turn)

Description	Nm	lb-in.	lb-ft
Nylon insert locknut "d"	27	239	20
Nylon insert locknut "f"	Tighten until it seats, then back off 1/4 turn		

MAINTENANCE

Corrosion Control Anode

Your outboard has corrosion control anodes at three different locations. An anode helps protect the outboard against galvanic corrosion by sacrificing its metal to be slowly corroded instead of the outboard metals.

The anode requires periodic inspection especially in saltwater which will accelerate the erosion. To maintain this corrosion protection, always replace the anode before it is completely eroded. Never paint or apply a protective coating on the anode as this will reduce effectiveness of the anode.

POWER TILT MODELS

One anode is the trim tab and another anode is installed on the swivel bracket. Two anodes are also located on the transom brackets.

MANUAL TILT MODELS

One anode is the trim tab and another anode is installed on the swivel bracket. One anode is also located on the transom brackets.

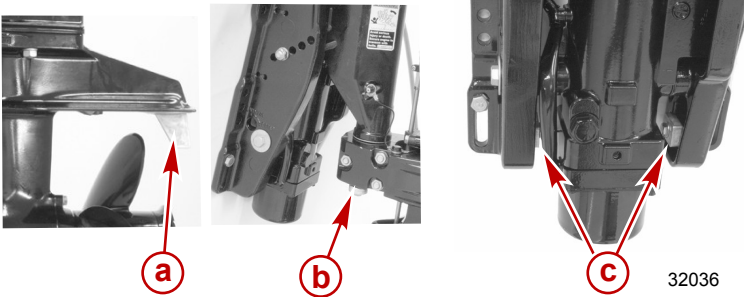

Power tilt models

MAINTENANCE

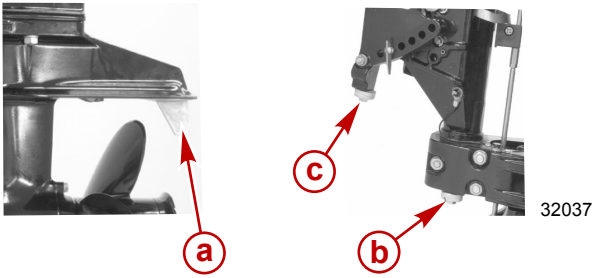

Manual tilt models

- a** - Trim tab
- b** - Swivel bracket anode
- c** - Transom bracket anode

Propeller Replacement

WARNING

Rotating propellers can cause serious injury or death. Never operate the boat out of the water with a propeller installed. Before installing or removing a propeller, place the drive unit in neutral and engage the lanyard stop switch to prevent the engine from starting. Place a block of wood between the propeller blade and the anti-ventilation plate.

1. Remove the spark plug leads to prevent the engine from starting.

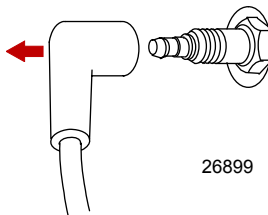

MAINTENANCE

2. Shift the outboard into neutral (N).

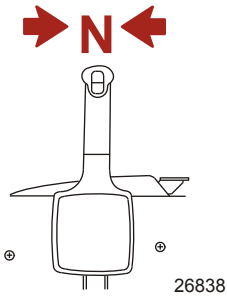

3. Straighten the cotter pin and pull it out using a pair of pliers.
4. Place a block of wood between the gearcase and the propeller to prevent rotation and remove the propeller nut.

MAINTENANCE

5. Pull the propeller straight off of the shaft. If the propeller is seized to the shaft and cannot be removed, have the propeller removed by an authorized dealer.

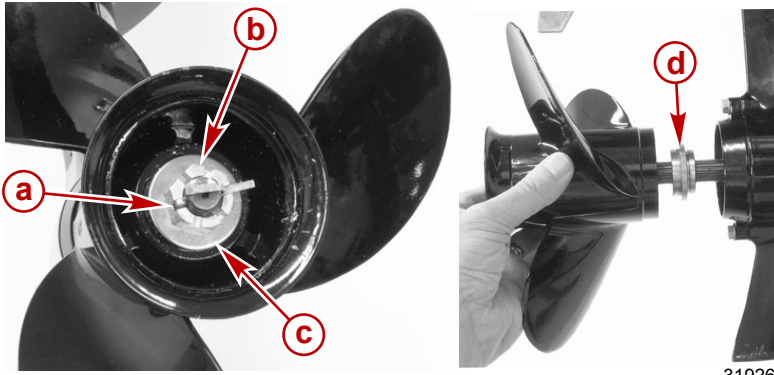

31926

- a** - Cotter pin
- b** - Nut
- c** - Rear thrust washer
- d** - Front thrust hub

IMPORTANT: To prevent the propeller hub from corroding and seizing to the propeller shaft (especially in saltwater), always apply a coat of the recommended lubricant to the entire propeller shaft at the recommended maintenance intervals and also each time the propeller is removed.

6. Coat the propeller shaft with Extreme Grease or 2-4-C with PTFE.



31927

MAINTENANCE

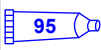
Tube Ref No.	Description	Where Used	Part No.
	Extreme Grease	Propeller shaft	8M0071842
	2-4-C with PTFE	Propeller shaft	92-802859A 1

- Install the front thrust hub onto the shaft so that the larger diameter end is facing the propeller.
- Install the propeller, rear thrust washer, and propeller nut onto the shaft.
- Place a block of wood between the gearcase and the propeller to prevent rotation and tighten the propeller nut to the specified torque.

NOTE: *If the propeller nut doesn't align with the propeller shaft hole after tightening, tighten the nut further to align with the hole.*

- Align the propeller nut with the propeller shaft hole. Insert a new cotter pin in the hole and bend the ends.

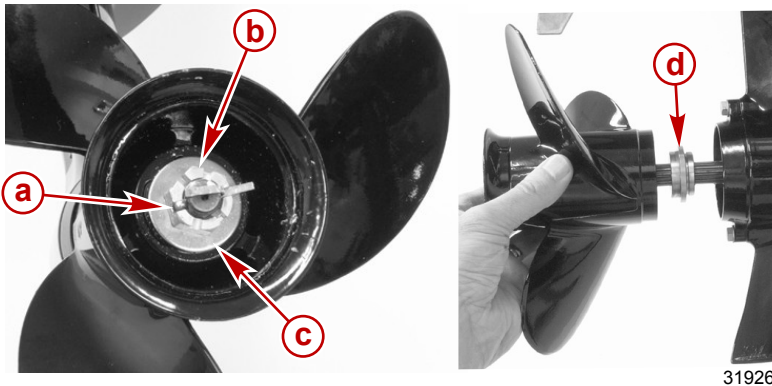

- a** - Cotter pin
- b** - Propeller nut
- c** - Rear thrust washer
- d** - Front thrust hub - Larger diameter end towards propeller

Description	Nm	lb-in.	lb-ft
Propeller nut	12	106	8

MAINTENANCE

Fuse Replacement - Electric Start Models

IMPORTANT: Always carry spare 20 amp fuses.

The voltage regulator circuit and the electric starting circuit are protected from overload by a 20 amp fuse. If the fuse is blown, try to locate and correct the cause of the overload. If the cause is not found, the fuse may blow again.

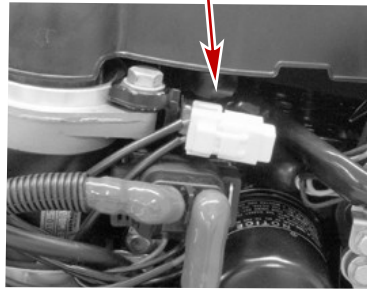
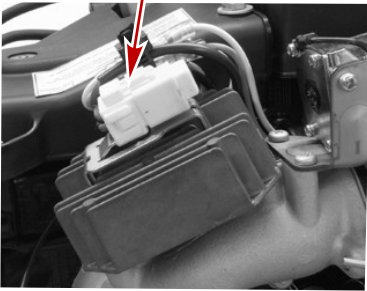
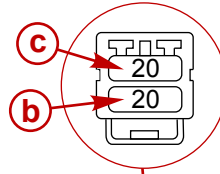
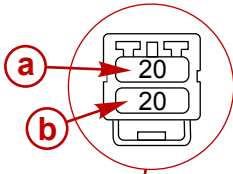

32119

- a** - Voltage regulator circuit - 20 amp fuse
- b** - Spare fuse
- c** - Electric starting circuit - 20 amp fuse

Open the fuse holder and look at the silver colored band inside the fuse. If band is broken, replace the fuse. Replace the fuse with a new fuse with the same rating.

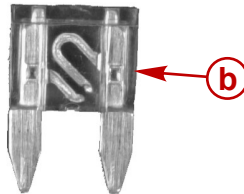
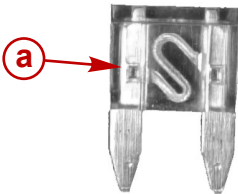

28619

Identifying a blown fuse

- a** - Good fuse
- b** - Blown fuse

MAINTENANCE

Spark Plug Inspection and Replacement

WARNING

Damaged spark plug boots may emit sparks that can ignite fuel vapors under the engine cowl, resulting in serious injury or death from a fire or explosion. To avoid damaging the spark plug boots, do not use any sharp object or metal tool to remove the spark plug boots.

1. Remove the spark plug boots. Twist the rubber boots slightly and pull off.

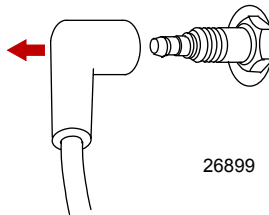

2. Remove the spark plugs to inspect. Replace the spark plug if electrode is worn or the insulator is rough, cracked, broken, blistered, or fouled.

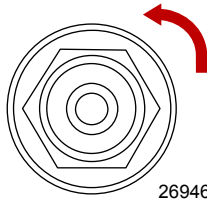

3. Set the spark plug gap to specification.

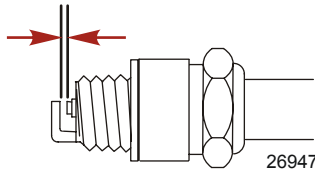

Spark Plug

Spark plug gap

0.9 mm (0.035 in.)

MAINTENANCE

4. Before installing the spark plugs, clean off any dirt on the spark plug seats. Install plugs finger-tight and then tighten 1/4 turn, or torque to specifications.

Description	Nm	lb. in.	lb. ft.
Spark plug	20		14

Timing Belt Inspection

Inspect the timing belt and have it replaced by an authorized dealer if any of the following conditions are found.

- Cracks in the back of the belt or in the base of the belt teeth
- Excessive wear at the roots of the cogs
- Rubber portion swollen by oil
- Belt surfaces roughened
- Signs of wear on edges or outer surfaces of belt

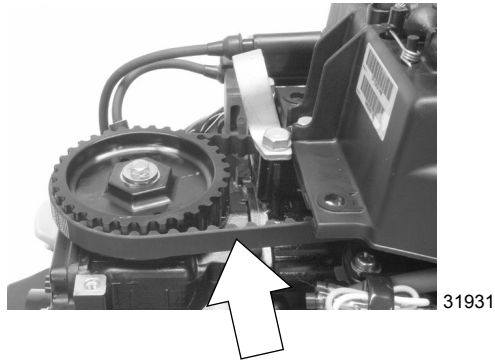

Changing Engine Oil

ENGINE OIL CAPACITY

Engine oil capacity is approximately 1.0 liter (1.1 U.S. quart).

OIL CHANGING PROCEDURE

1. Lock the outboard in the full tilt up position.
2. Position the outboard so the drain hole is facing downward.
3. Remove the drain plug and drain the engine oil into an appropriate container.

MAINTENANCE

IMPORTANT: Do not use a crankcase oil pump when changing the oil or engine damage may occur.

4. After the initial oil has been drained, temporarily install the drain plug. Disengage the tilt lock and lower the outboard. Wait a minute to allow the remaining oil that was trapped in the engine to return to the drain. Return outboard to the full tilt position and drain the remaining oil.
5. Lubricate the seal on the drain plug with oil and install. Tighten to the specified torque.

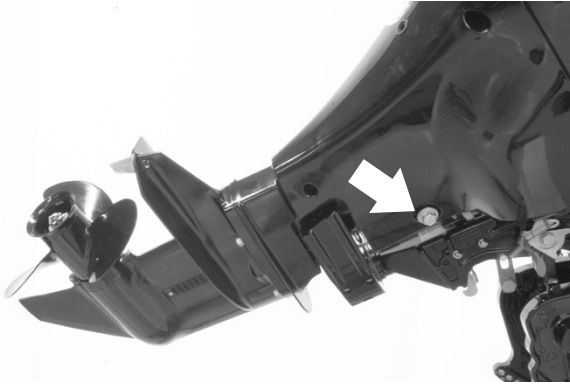

31922



4537

Description	Nm	lb. in.	lb. ft.
Drain plug	23.7	210	17

CHANGING OIL FILTER

1. Position the outboard in a level operating position.

MAINTENANCE

2. Electric start models - To gain clearance to the oil filter, remove the starter solenoid along with its rubber isolation mount from the metal plate that holds it.

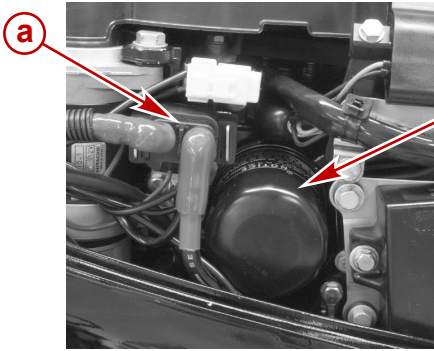

31995

Electric start model

- a - Starter solenoid
- b - Oil filter

3. Place a rag or towel below the oil filter to absorb any spilled oil.
4. Unscrew the old filter by turning the filter to the left.
5. Clean the mounting base. Apply a film of clean oil to the filter gasket. Do not use grease. Screw the new filter on until the gasket contacts the base, then tighten $3/4$ to 1 turn.
6. If the starter solenoid was removed, install the starter solenoid and rubber isolation mount to the metal plate.

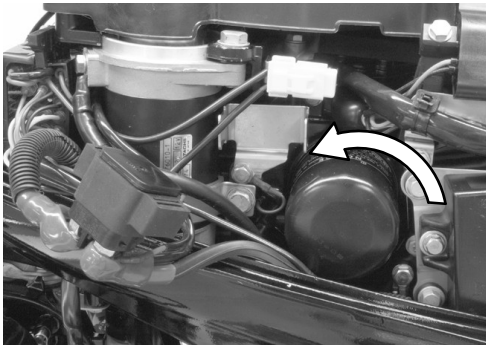

31993

OIL FILLING

IMPORTANT: Do not try to fill the oil level to the top of the operating range (upper hole). Oil level is correct as long as it appears in the operating range between the upper and lower hole.

MAINTENANCE

1. Position the outboard in a level operating position.
2. Remove the oil fill cap and add the recommended oil to the midpoint (middle hole) of the oil level operating range. Adding approximately 1.0 liter (1.1 U.S. quart) of oil will bring the oil level to the midpoint of the oil level range. Reinstall the oil fill cap.

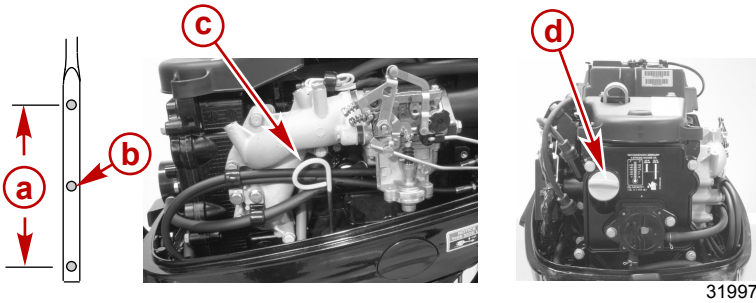



- a** - Oil level operating range
- b** - Midpoint
- c** - Dipstick
- d** - Oil fill cap

3. Idle engine for five minutes and check for leaks. Stop the engine and check the oil level on the dipstick. Add oil if necessary.

Lubrication Points

1. Lubricate the following with 2-4-C with PTFE or Extreme Grease.

Tube Ref No.	Description	Where Used	Part No.
	Extreme Grease	Swivel bracket, transom clamp screws, tilt tube, propeller shaft, steering cable grease	8M0071842
	2-4-C with PTFE	Swivel bracket, transom clamp screws, tilt tube, throttle/shift cables, steering cable grease fitting	92-802859A 1

MAINTENANCE

- Swivel bracket - Lubricate through fitting.

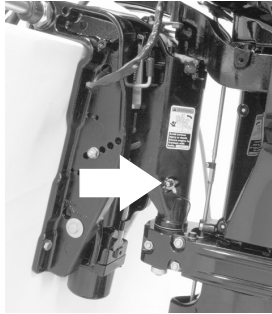

31934

- Transom clamp screws - Lubricate threads.
- Tilt tube - Lubricate through fittings.

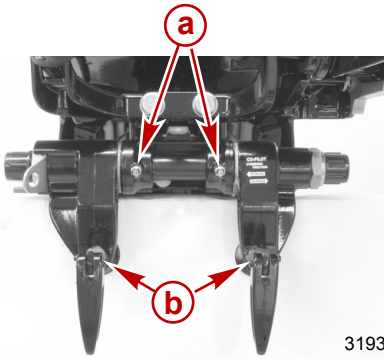

31936

- a** - Tilt tube - Lubrication fittings
- b** - Transom clamp screws

MAINTENANCE

- Steering cable lubrication fitting (if equipped) - Steer the outboard to fully retract the steering cable end into the outboard tilt tube. Lubricate the steering cable through the fitting.

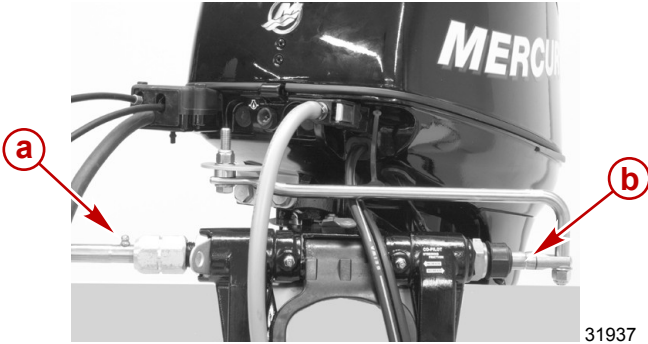

- a** - Steering cable lubrication fitting
- b** - Steering cable end

⚠ WARNING

Incorrect cable lubrication can cause hydraulic lock, leading to serious injury or death from loss of boat control. Completely retract the end of the steering cable before applying lubricant.

2. Lubricate the following with lightweight oil.
 - Steering link rod pivot points - Lubricate points.



3. Lubricate the following with Extreme Grease or 2-4-C with PTFE.

MAINTENANCE

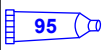
Tube Ref No.	Description	Where Used	Part No.
	Extreme Grease	Propeller shaft	8M0071842
	2-4-C with PTFE	Propeller shaft	92-802859A 1

- Propeller shaft - Refer to **Propeller Replacement** for removal and installation of the propeller. Coat the entire propeller shaft with lubricant to prevent the propeller hub from corroding to the shaft.



31927

Gearcase Lubrication

When adding or changing gearcase lubricant, visually check for the presence of water in the lubricant. If water is present, it may have settled to the bottom and will drain out prior to the lubricant, or it may be mixed with the lubricant, giving it a milky colored appearance. If water is noticed, have the gearcase checked by your dealer. Water in the lubricant may result in premature bearing failure or, in freezing temperatures, will turn to ice and damage the gearcase.

Remove the fill/drain plug and examine the lubricant draining from the gearcase for metal particles. A small amount of metal filings or fine metal particles indicates normal gear wear. An excessive amount of metal filings or larger particles (chips) may indicate abnormal gear wear and should be checked by an authorized dealer.

DRAINING GEARCASE

1. Place the outboard in a vertical operating position.
2. Place the drain pan below the outboard.

MAINTENANCE

3. Remove the fill/drain plug, vent plug, and drain the lubricant.

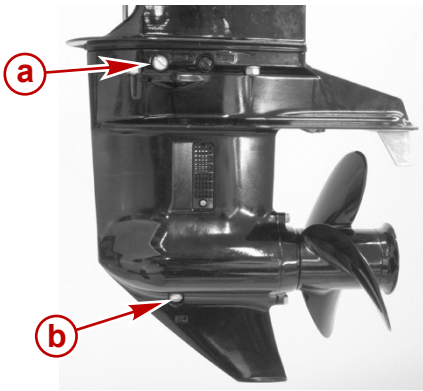

31932

- a** - Vent plug
- b** - Fill/drain plug

GEARCASE LUBRICANT CAPACITY

Approximately 370 ml (12.5 fl. oz.).

GEARCASE LUBRICANT RECOMMENDATION

Mercury or Quicksilver Premium or High Performance Gear Lubricant.

CHECKING LUBRICANT LEVEL AND REFILLING GEARCASE

1. Place the outboard in a vertical operating position.
2. Remove the vent plug from the vent hole.
3. Place the lubricant tube into the fill hole and add lubricant until it appears at the vent hole.

IMPORTANT: Replace the sealing washers with new sealing washers.

4. Stop adding lubricant. Install the vent plug and sealing washer before removing the lubricant tube.

MAINTENANCE

5. Remove the lubricant tube and install the cleaned fill/drain plug and new sealing washer.

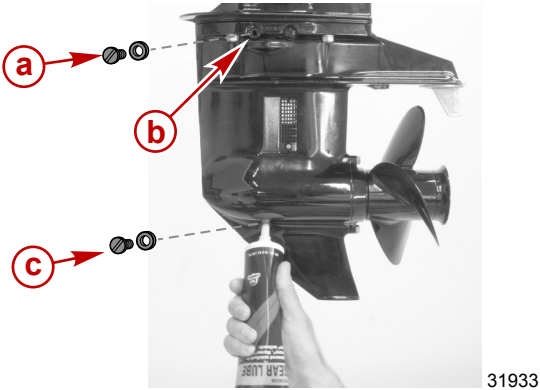

- a** - Vent plug and new sealing washer
- b** - Vent hole
- c** - Fill/drain plug and new sealing washer

Checking Power Tilt Fluid

1. Tilt the outboard to the full up position and engage the tilt support lever.

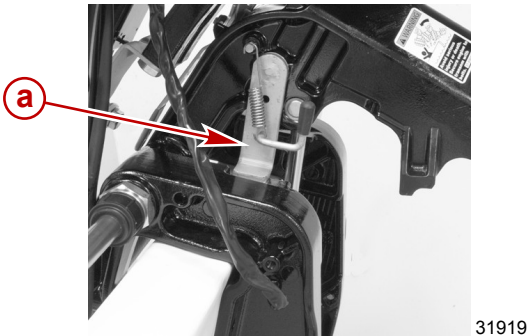

- a** - Tilt support lever

MAINTENANCE

2. Remove the fill cap and check the fluid level. The fluid level should be even with the bottom of the fill hole. Add Mercury or Quicksilver Power Trim and Steering Fluid. If not available, use automotive automatic transmission fluid (ATF).

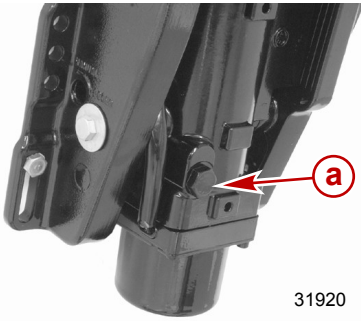

a - Fill cap

31920

Submerged Outboard

A submerged outboard will require service within a few hours by an authorized dealer once the outboard is recovered from the water. This immediate attention by a servicing dealer is necessary once the engine is exposed to the atmosphere to minimize internal corrosion damage to the engine.

STORAGE

Storage Preparation

The major consideration in preparing your outboard for storage is to protect it from rust, corrosion, and damage caused by freezing of trapped water.

The following storage procedures should be followed to prepare your outboard for out of season storage or prolonged storage (two months or longer).

NOTICE

Without sufficient cooling water, the engine, the water pump, and other components will overheat and suffer damage. Provide a sufficient supply of water to the water inlets during operation.

FUEL SYSTEM

IMPORTANT: Gasoline containing alcohol (ethanol or methanol) can cause a formation of acid during storage and can damage the fuel system. If the gasoline being used contains alcohol, it is advisable to drain as much of the remaining gasoline as possible from the fuel tank, remote fuel line, and engine fuel system.

Fill the fuel tank and engine fuel system with treated (stabilized) fuel to help prevent formation of varnish and gum. Proceed with the following instructions.

- Portable fuel tank - Pour the required amount of gasoline stabilizer (follow instructions on container) into fuel tank. Tip fuel tank back and forth to mix stabilizer with the fuel.
- Permanently installed fuel tank - Pour the required amount of gasoline stabilizer (follow instructions on container) into a separate container and mix with approximately 1 liter (1 U.S. quart) of gasoline. Pour this mixture into fuel tank.
- Place the outboard in water or connect flushing attachment for circulating cooling water. Run the engine for ten minutes to fill the engine fuel system.

STORAGE

Flushing Device	91-44357Q 2
 <p style="text-align: center;">9192</p>	<p>Attaches to the water intakes; provides a fresh water connection when flushing the cooling system or operating the engine.</p>

Protecting External Outboard Components

- Lubricate all outboard components listed in **Maintenance - Inspection and Maintenance Schedule**.
- Touch up any paint nicks. See your dealer for touch-up paint.
- Spray Quicksilver or Mercury Precision Lubricants Corrosion Guard on external metal surfaces (except corrosion control anodes).

Tube Ref No.	Description	Where Used	Part No.
	Corrosion Guard	External metal surfaces	92-802878 55

Protecting Internal Engine Components

- Remove the spark plugs and add approximately 30 ml (1 oz.) of engine oil or inject a five second spray of storage seal inside of each cylinder.
- Rotate the flywheel manually several times to distribute the oil in the cylinders. Install spark plugs.
- Change the engine oil.

Gearcase

- Drain and refill the gearcase lubricant (refer to **Gearcase Lubrication**).

STORAGE

Positioning Outboard for Storage

NOTICE

Storing the outboard in a tilted position can damage the outboard. Water trapped in the cooling passages or rain water collected in the propeller exhaust outlet in the gearcase can freeze. Store the outboard in the full down position.

- To prevent problems which can be caused by oil entering the cylinders from the sump, only store the outboard in one of the three positions shown.

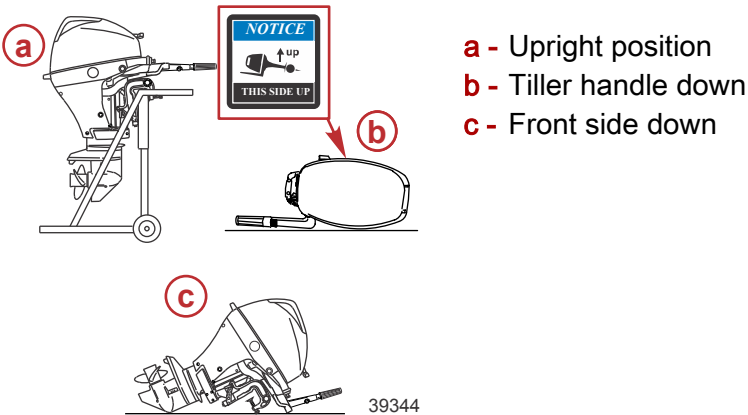

- Never carry, store, or transport the outboard in the two positions shown. Engine damage could result from oil draining out of the crankcase.

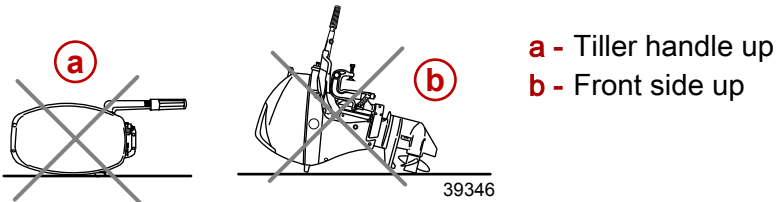

Battery Storage

- Follow the battery manufacturer's instructions for storage and charging.

STORAGE

- Remove the battery from the boat and check water level. Charge if necessary.
- Store the battery in a cool, dry place.
- Periodically check the water level and charge the battery during storage.

TROUBLESHOOTING

Starter Motor Will Not Crank the Engine (Electric Start Models)

POSSIBLE CAUSES

- Blown 20 amp fuse in the starting circuit. Refer to **Maintenance** section.
- Outboard is not shifted to neutral position.
- Weak battery or battery connections are loose or corroded.
- Ignition key switch/start button failure.
- Wiring or electrical connection faulty.
- Starter motor or starter solenoid failure.

Engine Will Not Start

POSSIBLE CAUSES

- Lanyard stop switch not in "RUN" position.
- Battery not fully charged.
- Incorrect starting procedure. Refer to **Operation** section.
- Old or contaminated fuel.
- Fuel is not reaching the engine.
 - Fuel tank is empty.
 - Fuel tank vent not open or restricted.
 - Fuel line is disconnected or kinked.
 - Primer bulb not squeezed.
 - Primer bulb check valve is faulty.
 - Fuel filter is obstructed. Refer to **Maintenance** section.
 - Fuel pump failure.
 - Fuel tank filter obstructed.
- Ignition system component failure.
- Spark plugs fouled or defective. Refer to **Maintenance** section.

Engine Runs Erratically

POSSIBLE CAUSES

- Low oil pressure. Check the oil level.

TROUBLESHOOTING

- Spark plugs fouled or defective. Refer to **Maintenance** section.
- Incorrect setup and adjustments.
- Fuel is being restricted to the engine.
 - a. Engine fuel filter is obstructed. Refer to **Maintenance** section.
 - b. Fuel tank filter obstructed.
 - c. Stuck anti-siphon valve located on permanently built in type fuel tanks.
 - d. Fuel line is kinked or pinched.
- Fuel pump failure.
- Ignition system component failure.

Performance Loss

POSSIBLE CAUSES

- Low oil pressure. Check the oil level.
- Throttle not fully open.
- Damaged or improper size propeller.
- Incorrect engine timing, adjustments, or setup.
- Boat overloaded or load improperly distributed.
- Excessive water in bilge.
- Boat bottom is dirty or damaged.

Battery Will Not Hold Charge

POSSIBLE CAUSES

- Battery connections are loose or corroded.
- Low electrolyte level in battery.
- Worn out or inefficient battery.
- Excessive use of electrical accessories.
- Defective rectifier, alternator, or voltage regulator.

OWNER SERVICE ASSISTANCE

Local Repair Service

Always return your outboard to your local authorized dealer should the need for service arise. Only he has the factory trained mechanics, knowledge, special tools, equipment, and genuine parts and accessories to properly service your engine should the need occur. He knows your engine best.

Service Away from Home

If you are away from your local dealer and the need arises for service, contact the nearest authorized dealer. Refer to the Yellow Pages of the telephone directory. If, for any reason, you cannot obtain service, contact the nearest Mercury Marine Service Office.

Parts and Accessories Inquiries

All inquiries concerning genuine replacement parts and accessories should be directed to your local authorized dealer. The dealer has the necessary information to order parts and accessories for you. When inquiring about parts and accessories, the dealer requires the model and serial number to order the correct parts.

Service Assistance

LOCAL REPAIR SERVICE

If you need service for your Mercury-outboard-powered boat, take it to your authorized dealer. Only authorized dealers specialize in Mercury products and have factory-trained mechanics, special tools and equipment, and genuine Quicksilver parts and accessories to properly service your engine.

NOTE: *Quicksilver parts and accessories are engineered and built by Mercury Marine specifically for your power package.*

OWNER SERVICE ASSISTANCE

SERVICE AWAY FROM HOME

If you are away from your local dealer and the need arises for service, contact the nearest authorized dealer. If, for any reason, you cannot obtain service, contact the nearest Regional Service Center. Outside the United States and Canada, contact the nearest Marine Power International Service Center.

STOLEN POWER PACKAGE

If your power package is stolen, immediately advise the local authorities and Mercury Marine of the model and serial numbers and to whom the recovery is to be reported. This information is maintained in a database at Mercury Marine to aid authorities and dealers in the recovery of stolen power packages.

ATTENTION REQUIRED AFTER SUBMERSION

1. Before recovery, contact an authorized Mercury dealer.
2. After recovery, immediate service by an authorized Mercury dealer is required to reduce the possibility of serious engine damage.

REPLACEMENT SERVICE PARTS

WARNING

Avoid fire or explosion hazard. Electrical, ignition, and fuel system components on Mercury Marine products comply with federal and international standards to minimize risk of fire or explosion. Do not use replacement electrical or fuel system components that do not comply with these standards. When servicing the electrical and fuel systems, properly install and tighten all components.

Marine engines are expected to operate at or near full throttle for most of their lives. They are also expected to operate in both fresh and saltwater environments. These conditions require numerous special parts.

OWNER SERVICE ASSISTANCE

PARTS AND ACCESSORIES INQUIRIES

Direct any inquiries concerning Quicksilver replacement parts and accessories to your local authorized dealer. The dealer has the necessary information to order parts and accessories for you if they are not in stock. Only authorized dealers can purchase genuine Quicksilver parts and accessories from the factory. Mercury Marine does not sell to unauthorized dealers or retail customers. When inquiring about parts and accessories, the dealer requires the **engine model** and **serial numbers** to order the correct parts.

RESOLVING A PROBLEM

Satisfaction with your Mercury product is important to your dealer and to us. If you ever have a problem, question or concern about your power package, contact your dealer or any authorized Mercury dealership. If you need additional assistance:

1. Talk with the dealership's sales manager or service manager. Contact the owner of the dealership if the sales manager and service manager have been unable to resolve the problem.
2. If your question, concern, or problem cannot be resolved by your dealership, please contact the Mercury Marine Service Office for assistance. Mercury Marine will work with you and your dealership to resolve all problems.

The following information will be needed by the Customer Service:

- Your name and address
- Your daytime telephone number
- The model and serial numbers of your power package
- The name and address of your dealership
- The nature of the problem

CONTACT INFORMATION FOR MERCURY MARINE CUSTOMER SERVICE

For assistance, call, fax, or write to the geographic office in your area. Please include your daytime telephone number with mail and fax correspondence.

OWNER SERVICE ASSISTANCE

United States, Canada		
Telephone	English +1 920 929 5040 Français +1 905 636 4751	Mercury Marine W6250 W. Pioneer Road P.O. Box 1939 Fond du Lac, WI 54936-1939
Fax	English +1 920 929 5893 Français +1 905 636 1704	
Website	www.mercurymarine.com	

Australia, Pacific		
Telephone	+61 3 9791 5822	Brunswick Asia Pacific Group 41-71 Bessemer Drive Dandenong South, Victoria 3175 Australia
Fax	+61 3 9706 7228	

Europe, Middle East, Africa		
Telephone	+32 87 32 32 11	Brunswick Marine Europe Parc Industriel de Petit-Rechain B-4800 Verviers, Belgium
Fax	+32 87 31 19 65	

Mexico, Central America, South America, Caribbean		
Telephone	+1 954 744 3500	Mercury Marine 11650 Interchange Circle North Miramar, FL 33025 U.S.A.
Fax	+1 954 744 3535	

Japan		
Telephone	+81 72 233 8888	Kisaka Co., Ltd. 4-130 Kannabecho, Sakai-ku Sakai-shi, Osaka 590-0984, Japan
Fax	+81 72 233 8833	

Asia, Singapore		
Telephone	+65 65466160	Brunswick Asia Pacific Group T/A Mercury Marine Singapore Pte Ltd 29 Loyang Drive Singapore, 508944
Fax	+65 65467789	

Ordering Literature

Before ordering literature, have the following information about your power package available:

OWNER SERVICE ASSISTANCE

Model		Serial Number	
Horsepower		Year	

UNITED STATES AND CANADA

For additional literature for your Mercury Marine power package, contact your nearest Mercury Marine dealer or contact:

Mercury Marine		
Telephone	Fax	Mail
(920) 929-5110 (USA only)	(920) 929-4894 (USA only)	Mercury Marine Attn: Publications Department P.O. Box 1939 Fond du Lac, WI 54935-1939

OUTSIDE THE UNITED STATES AND CANADA

Contact your nearest Mercury Marine authorized service center to order additional literature that is available for your particular power package.

Submit the following order form with payment to:	Mercury Marine Attn: Publications Department W6250 West Pioneer Road P.O. Box 1939 Fond du Lac, WI 54936-1939
Ship To: (Copy this form and print or type—This is your shipping label)	
Name	
Address	
City, State, Province	
ZIP or postal code	
Country	

Quantity	Item	Stock Number	Price	Total
			.	.
			.	.
			.	.
			.	.
			.	.
Total Due				.

ENGINE INSTALLATION

Boat Horsepower Capacity

WARNING

Exceeding the boat's maximum horsepower rating can cause serious injury or death. Overpowering the boat can affect boat control and flotation characteristics or break the transom. Do not install an engine that exceeds the boat's maximum power rating.

Do not overpower or overload your boat. Most boats will carry a required capacity plate indicating the maximum acceptable power and load as determined by the manufacturer following certain federal guidelines. If in doubt, contact your dealer or the boat manufacturer.

U.S. COAST GUARD CAPACITY	
MAXIMUM HORSEPOWER	XXX
MAXIMUM PERSON CAPACITY (POUNDS)	XXX
MAXIMUM WEIGHT CAPACITY	XXX

26777

Start in Gear Protection

WARNING

Starting the engine with the drive in gear can cause serious injury or death. Never operate a boat that does not have a neutral-safety-protection device.

The remote control connected to the outboard must be equipped with a start in neutral only protection device. This prevents the engine from starting in gear.

ENGINE INSTALLATION

Selecting Accessories for Your Outboard

Genuine Mercury Precision or Quicksilver Accessories have been specifically designed and tested for your outboard. These accessories are available from Mercury Marine dealers.

IMPORTANT: Check with your dealer before installing accessories. The misuse of approved accessories or the use of nonapproved accessories can damage the product.

Some accessories not manufactured or sold by Mercury Marine are not designed to be safely used with your outboard or outboard operating system. Acquire and read the installation, operation and maintenance manuals for all your selected accessories.

Low Permeation Fuel Hose Requirement

Required for outboards manufactured for sale, sold, or offered for sale in the United States.

- The Environmental Protection Agency (EPA) requires that any outboard manufactured after January 1, 2009, must use low permeation fuel hose for the primary fuel hose connecting the fuel tank to the outboard.
- Low permeation hose is USCG Type B1-15 or Type A1-15, defined as not exceeding $15/\text{gm}^2/24 \text{ h}$ with CE 10 fuel at $23 \text{ }^\circ\text{C}$ as specified in SAE J 1527 - marine fuel hose.

Lifting the Outboard

Use the lifting eye on the engine.



32072

ENGINE INSTALLATION

Installing Outboard

BOAT TRANSOM HEIGHT REQUIREMENT

Measure the transom height of your boat. The boat bottom should be aligned or be within 25 mm (1 in.) above the anti-ventilation plate of the outboard.

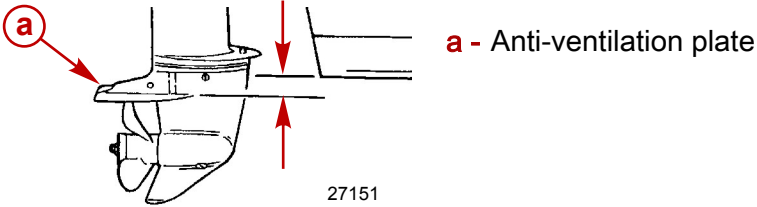

INSTALLING OUTBOARD ON TRANSOM

⚠ WARNING

Failure to correctly fasten the outboard could result in the outboard propelling off the boat transom resulting in property damage, serious injury, or death. Before operation, the outboard must be correctly installed with the required mounting hardware.

This product must be secured to the transom with the required mounting hardware. If the outboard strikes an under water object, the required mounting hardware prevents the outboard from propelling off the transom. A decal on the swivel bracket reminds the installer of the potential hazard.

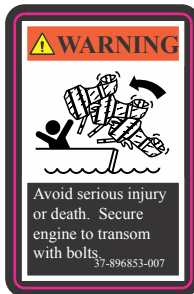

52375

ENGINE INSTALLATION

1. Place the outboard on the centerline of the transom.

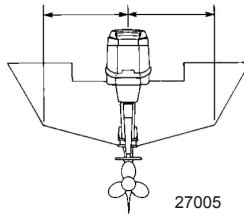

2. Tighten the transom bracket clamp screws.

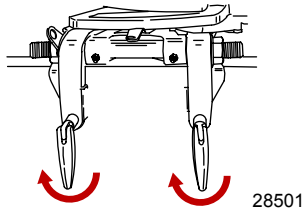

3. To prevent a loss of the outboard, secure the outboard to the transom with the two transom bracket clamp screws and two mounting bolts. Drill two 7.9 mm (5/16 in.) holes through the transom bracket mounting holes. Fasten with two bolts, flat washers, and locknuts. Use a marine waterproofing sealer in the holes and around the bolts to make the installation water tight. Tighten the bolts to the specified torque.

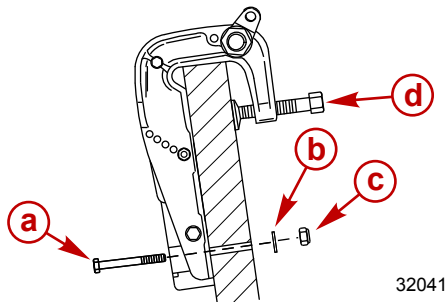

Power tilt models

ENGINE INSTALLATION

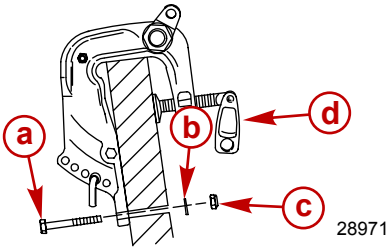

Manual tilt models

- a** - Bolt (2)
- b** - Washer (2)
- c** - Locknut (2)
- d** - Transom bracket clamp screw (2)

Description	Nm	lb-in.	lb-ft
Transom bracket mounting bolts	13.5		10

Steering Cable Installation

1. Lubricate the entire cable end with Mercury or Quicksilver 2-4-C with PTFE.

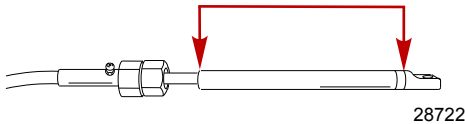

Tube Ref No.	Description	Where Used	Part No.
 95	2-4-C with PTFE	Steering cable end	92-802859A 1

2. Insert the steering cable into the tilt tube.

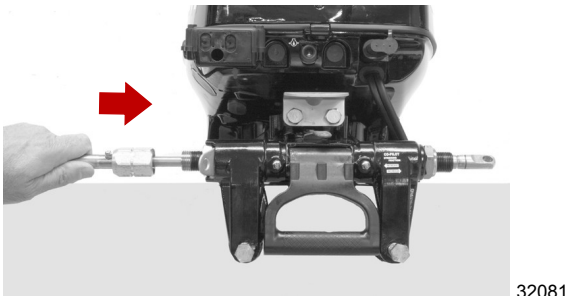

3. Tighten the steering cable nut to the specified torque.

ENGINE INSTALLATION

4. Thread the steering cable seal onto the end of the tilt tube.

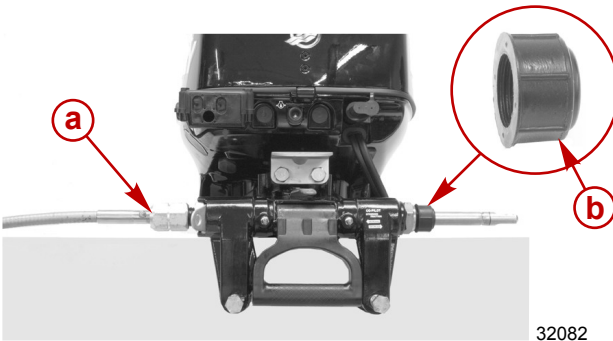

- a** - Steering cable nut
b - Steering cable seal

Description	Nm	lb-in.	lb-ft
Steering cable nut	47.5		35

Steering Link Rod Fasteners

IMPORTANT: The steering link rod that connects the steering cable to the engine must be fastened using the steering link rod fastening hardware supplied with engine. Never replace the locknuts (11-16147--3) with common nuts (non-locking) as they will work loose and vibrate off, freeing the link rod to disengage.

⚠ WARNING

Improper fasteners or improper installation procedures can result in loosening or disengagement of the steering link rod. This can cause a sudden, unexpected loss of boat control, resulting in serious injury or death due to occupants being thrown within or out of the boat. Always use required components and follow instructions and torque procedures.

Assemble the steering link rod to the steering cable with a flat washer and nylon insert locknut. Tighten locknut until it seats, then back nut off 1/4 turn.

ENGINE INSTALLATION

Assemble the steering link rod to the engine with bolt, locknut, spacer, and flat washers. Torque the locknut to specifications.

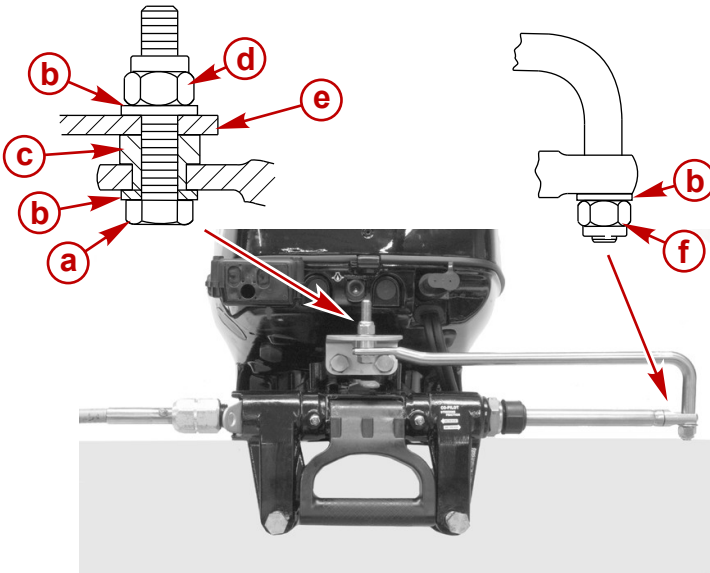

31917

- a** - Bolt (12-71970)
- b** - Flat washer
- c** - Spacer
- d** - Nylon insert locknut (11-16147--3)
- e** - Steering bracket
- f** - Nylon insert locknut (11-16147--3) (tighten until it seats, then back off 1/4 turn)

Description	Nm	lb-in.	lb-ft
Nylon insert locknut "d"	27	239	20
Nylon insert locknut "f"	Tighten until it seats, then back off 1/4 turn		

ENGINE INSTALLATION

Remote Wiring Harness and Control Cable Installation

REMOTE WIRE HARNESS CONNECTION

1. Remove the two bolts and remove the access cover.

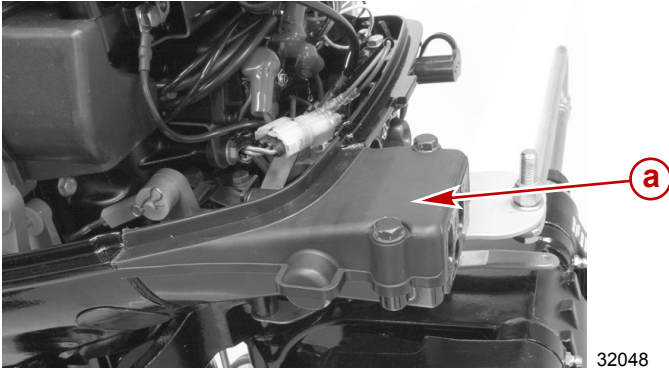

- a** - Access cover
2. Connect the remote harness to the engine harness connector.
 3. Route the remote wiring harness through the rubber grommet.

ENGINE INSTALLATION

4. Connect the 8 pin connector to the engine harness. If the outboard is equipped with power tilt, connect the power tilt wire connections.

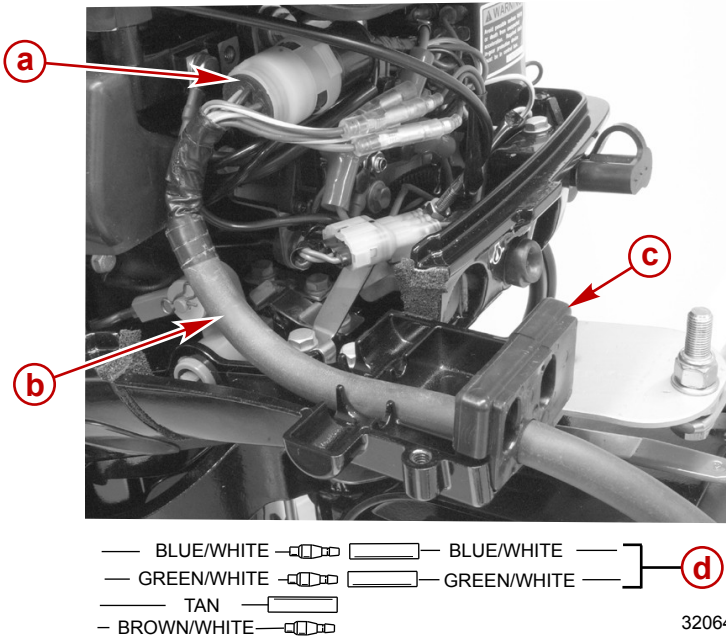

- a** - 8 pin connector
 - b** - Remote wiring harness
 - c** - Rubber grommet
 - d** - Power tilt wire connections
5. Route the remote wiring harness through the rubber grommet.
 6. Open up the clamp in the bottom cowl and position the remote wiring harness below the clamp. Connect the 8 pin connector to the engine harness. Push the clamp down and secure the remote wiring harness into the bottom cowl.

SHIFT CABLE INSTALLATION

Install the cables into the remote control following the instructions provided with the remote control.

ENGINE INSTALLATION

NOTE: The shift cable is the first cable to move when moving the control box out of neutral.

1. Locate the center point of the slack or lost motion that exists in the shift cable as follows:
 - a. Move the remote control handle from neutral into forward and advance the handle to full speed position. Slowly return the handle back to neutral. Place a mark ("a") on the cable next to the end guide.
 - b. Move the remote control handle from neutral into reverse and advance the handle to full speed position. Slowly return the handle back to neutral. Place a mark ("b") on the cable next to the end guide.
 - c. Make a center mark ("c"), midway between marks ("a" and "b"). Align the end guide with this center mark when installing cable to the engine.

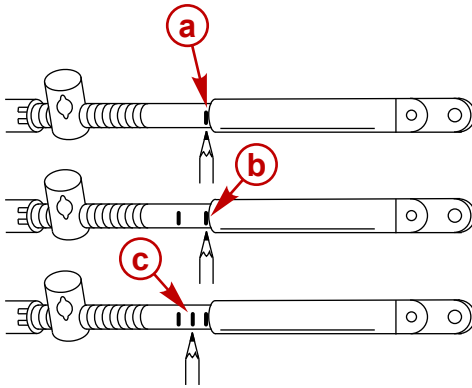

6098

2. Position the remote control handle into neutral.
3. Manually move the shift lever on the engine forward to gain clearance for attaching the cable.

ENGINE INSTALLATION

4. Attach the shift cable to the shift lever with a washer and cotter pin retainer.

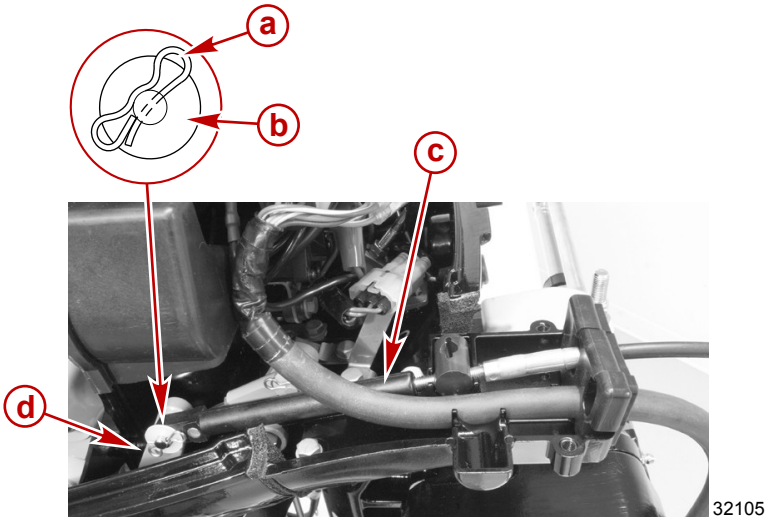

- a** - Cotter pin retainer
- b** - Flat washer
- c** - Shift cable
- d** - Shift lever

5. Manually shift the outboard into neutral (propeller will rotate freely).
6. Adjust the cable barrel so the center mark on the cable is aligned with the end guide when the cable barrel is placed in the barrel receptacle.

ENGINE INSTALLATION

7. Position the shift cable into the rubber grommet and place the cable barrel into the barrel receptacle.

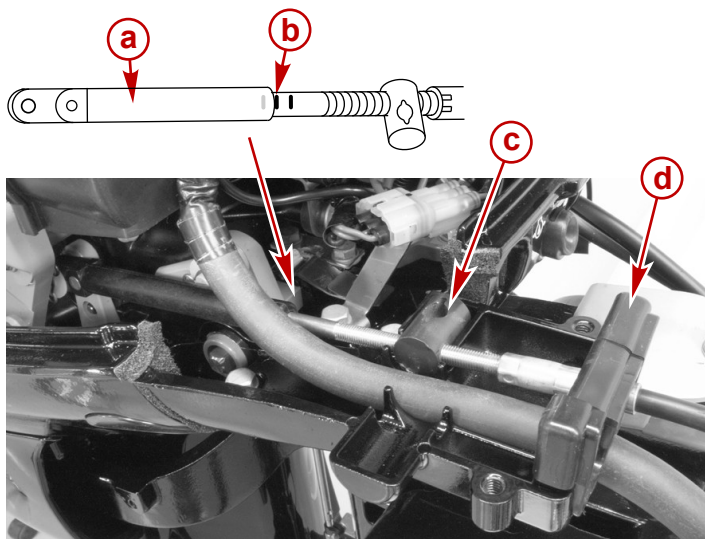

32068

- a** - End guide
- b** - Center mark
- c** - Cable barrel
- d** - Rubber grommet

8. Check shift cable adjustments as follows:
- a. Shift the remote control into forward. The propeller shaft should be locked in gear. If not, adjust the barrel closer to the cable guide.
 - b. Shift the remote control into reverse while turning the propeller. The propeller shaft should be locked in gear. If not, adjust the barrel away from the cable guide. Repeat steps a through c.
 - c. Shift the remote control back to neutral. The propeller shaft should turn freely without drag. If not, adjust the barrel closer to the cable guide. Repeat steps a through c.

ENGINE INSTALLATION

THROTTLE CABLE INSTALLATION

Install the cables into the remote control following the instructions provided with the remote control.

1. Position the remote control handle into full forward throttle position.
2. Attach the throttle cable end guide to the throttle lever with a washer and cotter pin retainer.
3. Adjust the cable barrel so that the installed throttle cable will hold the lever on the carburetor against the full throttle stop.
4. Position the throttle cable into the rubber grommet and place the cable barrel into the barrel receptacle.

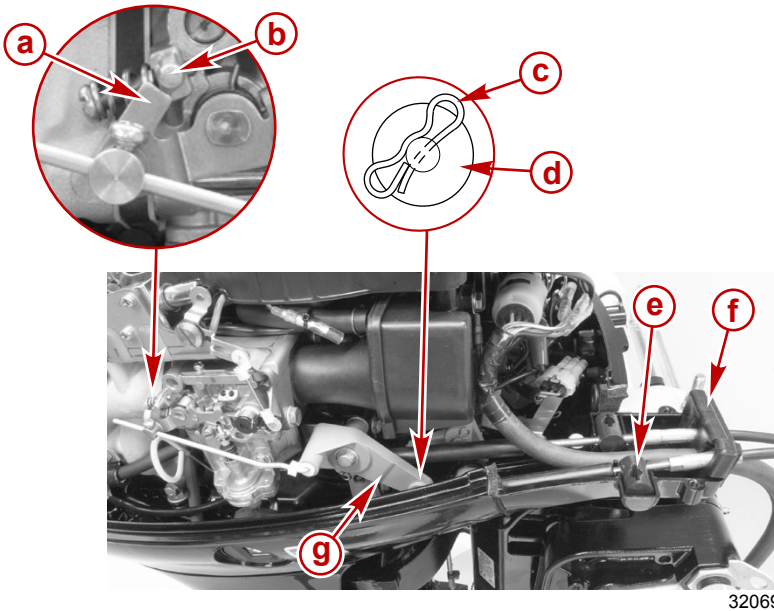

32069

- a** - Carburetor lever
- b** - Full throttle stop
- c** - Cotter pin retainer
- d** - Flat washer
- e** - Cable barrel
- f** - Rubber grommet
- g** - Throttle lever

ENGINE INSTALLATION

5. Install the access cover with two bolts. Tighten the bolts to the specified torque.

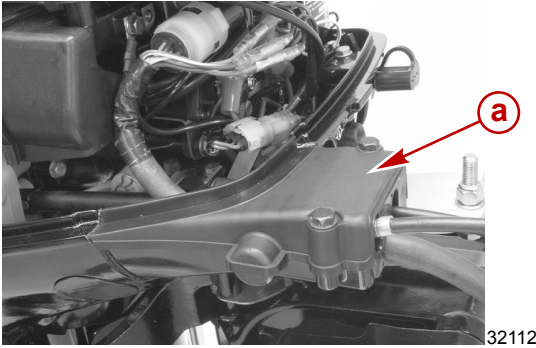

a - Access cover

Description	Nm	lb. in.	lb. ft.
Access cover bolt	6	53	

Battery Installation - Electric Start Models

MOUNTING BATTERY

Follow the battery manufacturer's instructions carefully. Mount battery in the boat so it is secured against movement, preferably in a battery box. Make sure battery is equipped with a nonconductive shield to prevent accidental shorting of battery terminals.

NOTE: *Electric starting outboards must have the battery cables connected to a battery whenever the engine is running, even if started manually, as damage to the charging system could result.*

Battery Connections

CONNECTING OUTBOARD BATTERY CABLES

First, connect the red battery cable to the (+) positive battery terminal and then connect the black battery cable to the (-) negative battery terminal.

ENGINE INSTALLATION

DISCONNECTING OUTBOARD BATTERY CABLES

First, disconnect the black battery cable from the (-) negative terminal and then disconnect the red battery cable from the (+) positive terminal.

