

## Thank You

for your purchase of one of the finest outboards available. You have made a sound investment in boating pleasure. Your outboard has been manufactured by Mercury Marine, a world leader in marine technology and outboard manufacturing since 1939. These years of experience have been committed to the goal of producing the finest quality products. This led to Mercury Marine's reputation for strict quality control, excellence, durability, lasting performance, and being the best at providing after the sale support.

Please read this manual carefully before operating your outboard. This manual has been prepared to assist you in the operation, safe use, and care of your outboard.

All of us at Mercury Marine took pride in building your outboard and wish you many years of happy and safe boating.

Again, thank you for your confidence in Mercury Marine.

## EPA Emissions Regulations

Outboards sold by Mercury Marine in the United States are certified to the United States Environmental Protection Agency as conforming to the requirements of the regulations for the control of air pollution from new outboard motors.

This certification is contingent on certain adjustments being set to factory standards. For this reason, the factory procedure for servicing the product must be strictly followed and, wherever practicable, returned to the original intent of the design. **Maintenance, replacement, or repair of the emission control devices and systems may be performed by any marine engine repair establishment or individual.**

Engines are labeled with an Emission Control Information decal as permanent evidence of EPA certification.

### WARNING

The engine exhaust from this product contains chemicals known to the state of California to cause cancer, birth defects or other reproductive harm.

## Warranty Message

The product you have purchased comes with a **limited warranty** from Mercury Marine, the terms of the warranty are set forth in the **Warranty Information** section of this manual. The warranty statement contains a description of what is covered, what is not covered, the duration of coverage, how to best obtain warranty coverage, **important disclaimers and limitations of damages**, and other related information. Please review this important information.

The description and specifications contained herein were in effect at the time this manual was approved for printing. Mercury Marine, whose policy is one of continued improvement, reserves the right to discontinue models at any time, to change specifications, designs, methods, or procedures without notice and without incurring obligation.

Mercury Marine, Fond du Lac, Wisconsin U.S.A.

Litho in U.S.A.

© 2011, Mercury Marine

Mercury, Mercury Marine, MerCruiser, Mercury MerCruiser, Mercury Racing, Mercury Precision Parts, Mercury Propellers, Mariner, Quicksilver, #1 On The Water, Alpha, Bravo, Pro Max, OptiMax, Sport-Jet, K-Planes, MerCathode, RideGuide, SmartCraft, Zero Effort, M with Waves logo, Mercury with Waves logo, and SmartCraft logo are all registered trademarks of Brunswick Corporation. Mercury Product Protection logo is a registered service mark of Brunswick Corporation.

## Mercury Premier Service

Mercury evaluates the service performance of its dealers and assigns its highest rating of "Mercury Premier" to those demonstrating an exceptional commitment to service.

### **Earning a Mercury Premier Service rating means a dealer:**

- Achieves a high 12 month service CSI (Customer Satisfaction Index) score for warranty service.
- Possesses all necessary service tools, test equipment, manuals, and parts books.
- Employs at least one Certified or Master technician.

- Provides timely service for all Mercury Marine customers.
- Offers extended service hours and mobile service, when appropriate.
- Uses, displays, and stocks adequate inventory of genuine Mercury Precision Parts.
- Offers a clean, neat shop with well organized tools and service literature.

**Declaration of Conformity 2.5, 3.5 hp - For Recreational Craft Propulsion Engines with the Requirements of Directive 94/25/EC as amended by 2003/44/EC**

**Name of engine manufacturer:** Tohatsu Marine Corporation (TMC) Mercury Marine Joint Venture  
**Address:** Shimodaira 4495-9  
**Town:** Komagane-City, Nagano      **Post Code:** 399-4101      **Country:** Japan

**Name of Authorized Representative:** Brunswick Marine in EMEA Inc.  
**Address:** Parc Industriel de Petit-Rechain  
**Town:** Verviers      **Post Code:** B-2800      **Country:** Belgium

**Name of Notified Body for exhaust emission assessment:** TUV SUD Group  
**Address:** Ridlerstrasse 65  
**Town:** Munich      **Post Code:** 80339      **Country:** Germany      **ID Number:** 0123

**Name of Notified Body for noise emission assessment:** TUV SUD Group  
**Address:** Ridlerstrasse 65  
**Town:** Munich      **Post Code:** 80339      **Country:** Germany      **ID Number:** 0123

<b>Conformity assessment module used for exhaust emissions:</b>	<input checked="" type="checkbox"/> B +C	<input type="checkbox"/> B +D	<input type="checkbox"/> B +E	<input type="checkbox"/> B +F	<input type="checkbox"/> G	<input type="checkbox"/> H
<b>or engine type approved according to:</b>	<input type="checkbox"/> Stage II of Directive 97/68/EC			<input type="checkbox"/> Directive 88/77/EC		
<b>Conformity assessment module used for noise emissions:</b>	<input type="checkbox"/> A	<input checked="" type="checkbox"/> Aa	<input type="checkbox"/> G	<input type="checkbox"/> H		
<b>Other Community Directives applied: Safety of Machinery Directive 98/37/EC; Electromagnetic Compatibility Directive 2004/108/EC</b>						

### Description of Engines and Essential Requirements

Engine Type	Fuel Type	Combustion Cycle
<input type="checkbox"/> z or sterndrive without integral exhaust	<input type="checkbox"/> Diesel	<input type="checkbox"/> 2 stroke
<input checked="" type="checkbox"/> Outboard engine	<input checked="" type="checkbox"/> Petrol	<input checked="" type="checkbox"/> 4 stroke

### Identification of Engines Covered by This Declaration of Conformity

Name of engine family	Unique engine identification number: starting serial number	EC Type-examination certificate or type-approval certificate number
2.5, 3.5 hp	OR333321	SB5 07 12 57840 005

Essential requirements	Standards	Other normative document/ method	Technical file	Please specify in more detail (* = mandatory standard)
<b>Annex 1.B—Exhaust Emissions</b>				
B.1 engine identification	<input type="checkbox"/>	<input type="checkbox"/>	<input checked="" type="checkbox"/>	
B.2 exhaust emission requirements	<input checked="" type="checkbox"/> *	<input type="checkbox"/>	<input type="checkbox"/>	* EN ISO 8178-1:1996
B.3 durability	<input type="checkbox"/>	<input type="checkbox"/>	<input checked="" type="checkbox"/>	
B.4 owner's manual	<input checked="" type="checkbox"/>	<input type="checkbox"/>	<input type="checkbox"/>	ISO 8665: 1995
<b>Annex 1.C—Noise Emissions</b>				
C.1 Noise emission levels	<input checked="" type="checkbox"/> *	<input type="checkbox"/>	<input type="checkbox"/>	EN ISO 14509
C.2 Owner's manual	<input type="checkbox"/>	<input checked="" type="checkbox"/>	<input type="checkbox"/>	Owner's manual

This declaration of conformity is issued under the sole responsibility of the manufacturer. I declare on behalf of the engine manufacturer that the engines mentioned preceding complies with all applicable essential requirements in the way specified.

**Name / function:**

Mark D. Schwabero, President,  
Mercury Outboard



**Date and place of issue:**

July 24, 2008  
Fond du Lac, Wisconsin, USA



---

## WARRANTY INFORMATION

---

Warranty Registration.....	1
Transfer of Warranty.....	2
Transfer of Mercury Product Protection (Extended Service Coverage) Plan United States and Canada.....	2
FourStroke Outboard Limited Warranty.....	3
FourStroke Outboard Limited Warranty.....	7
FourStroke Outboard Limited Warranty.....	11
3 Year Limited Warranty Against Corrosion.....	15
Warranty Coverage and Exclusions.....	18
U.S. EPA Emissions Limited Warranty.....	20
Emission Control System Components.....	20
California Emissions Limited Warranty.....	21
California Air Resources Board Explanation of Your California Emission Control Warranty Statement.....	25
Emission Certification Star Label.....	26

---

## GENERAL INFORMATION

---

Boater's Responsibilities.....	28
Before Operating Your Outboard.....	28
Boat Horsepower Capacity.....	29
Lanyard Stop Switch.....	29
Protecting People in the Water.....	32
Exhaust Emissions.....	32
Selecting Accessories for Your Outboard.....	34
Safe Boating Suggestions.....	35
Recording Serial Number.....	37
Specifications.....	37

---

## INSTALLATION

---

Installing the Outboard.....	39
------------------------------	----

---

## TRANSPORTING

---

Carrying, Storing, and Transporting the Outboard When Removed from Boat.....	40
Trailing the Boat.....	41

---

## FUEL AND OIL

---

Fuel Recommendations.....	42
Special Features of the Fuel Tank.....	44
Filling the Fuel Tank.....	45
Engine Oil Recommendations.....	45
Checking Engine Oil.....	46

---

## FEATURES AND CONTROLS

---

Features and Controls.....	48
Tilting Outboard.....	50
Setting the Operating Angle of the Outboard .....	51

---

## OPERATION

---

Prestarting Check List.....	52
Operating in Freezing Temperatures.....	52
Operating in Saltwater or Polluted Water.....	53
Engine Break-in Procedure.....	53
Starting the Engine.....	53
Gear Shifting.....	57
Reversing Boat.....	57
Stopping the Engine.....	58



---

## MAINTENANCE

---

Outboard Care.....	59
EPA Emission Regulations.....	59
Inspection and Maintenance Schedule.....	60
Flushing the Cooling System.....	62
Top Cowl Removal and Installation.....	63
Corrosion Control Anode.....	63
Exterior Care.....	64
Propeller Replacement.....	64
Spark Plug Inspection and Replacement.....	66
Lubrication Points.....	67
Changing Engine Oil .....	69
Gearcase Lubrication.....	70
Submerged Outboard.....	72

---

## STORAGE

---

Storage Preparation.....	73
Protecting External Outboard Components.....	73
Protecting Internal Engine Components.....	74
Gearcase.....	74
Positioning Outboard for Storage.....	74

---

## OWNER SERVICE ASSISTANCE

---

Local Repair Service.....	76
Service Away from Home.....	76
Parts and Accessories Inquiries.....	76
Service Assistance.....	76
Mercury Marine Service Offices.....	77

---

## MAINTENANCE LOG

---

Maintenance Log.....	79
----------------------	----



# WARRANTY INFORMATION

## Warranty Registration

### UNITED STATES AND CANADA

To be eligible for warranty coverage, the product must be registered with Mercury Marine.

At the time of sale, the selling dealer should complete the warranty registration and immediately submit it to Mercury Marine via MercNET, e-mail, or mail. Upon receipt of this warranty registration, Mercury Marine will record the registration.

A copy of the warranty registration should be provided to you by your selling dealer.

***NOTE:*** *Registration lists must be maintained by Mercury Marine and any dealer on marine products sold in the United States, should a safety recall notification under the Federal Safety Act be required.*

You may change your address at any time, including at time of warranty claim, by calling Mercury Marine or sending a letter or fax with your name, old address, new address, and engine serial number to Mercury Marine's warranty registration department.

Your dealer can also process this change of information.

Mercury Marine

Attn: Warranty Registration Department

W6250 W. Pioneer Road

P.O. Box 1939

Fond du Lac, WI 54936-1939

920-929-5054

Fax +1 920 929 5893

### OUTSIDE UNITED STATES AND CANADA

For products purchased outside the United States and Canada, contact the distributor in your country, or the Marine Power Service Center closest to you.

# WARRANTY INFORMATION

## Transfer of Warranty

### UNITED STATES AND CANADA

The limited warranty is transferable to a subsequent purchaser, but only for the remainder of the unused portion of the limited warranty. This will not apply to products used for commercial applications.

To transfer the warranty to the subsequent owner, send or fax a copy of the bill of sale or purchase agreement, new owner's name, address, and engine serial number to Mercury Marine's warranty registration department. In the United States and Canada, mail to:

Mercury Marine  
Attn: Warranty Registration Department  
W6250 W. Pioneer Road  
P.O. Box 1939  
Fond du Lac, WI 54936-1939  
920-929-5054  
Fax +1 920 929 5893

Upon processing the transfer of warranty, Mercury Marine will record the new owner's information.

There is no charge for this service.

### OUTSIDE THE UNITED STATES AND CANADA

For products purchased outside the United States and Canada, contact the distributor in your country, or the Marine Power Service Center closest to you.

## Transfer of Mercury Product Protection (Extended Service Coverage) Plan United States and Canada

The remaining coverage period of the Product Protection Plan is transferable to the subsequent purchaser of the engine within thirty (30) days from the date of sale. Contracts not transferred within thirty (30) days of the subsequent purchase will no longer be valid and the product will no longer be eligible for coverage under the terms of the contract.

# WARRANTY INFORMATION

To transfer the plan to the subsequent owner, contact Mercury Product Protection or an authorized dealer to receive a Request for Transfer form. Submit to Mercury Product Protection a receipt/bill of sale, a completed Request of Transfer form, and a check payable to Mercury Marine in the amount of \$50.00 (per engine) to cover the transfer fee.

Plan coverage is not transferable from one product to another product or for non-eligible applications.

The Certified Pre-Owned engine plans are not transferable.

For help or assistance, contact Mercury Product Protection Department at 1-888-427-5373 from 7:30 a.m. to 4:30 p.m. CST, Monday–Friday or email [mpp\\_support@mercmarine.com](mailto:mpp_support@mercmarine.com).

## FourStroke Outboard Limited Warranty

### UNITED STATES AND CANADA

*Outside the United States and Canada - Check with your local distributor.*

**WHAT IS COVERED:** Mercury Marine warrants its new products to be free of defects in material and workmanship during the period described below.

# WARRANTY INFORMATION

**DURATION OF COVERAGE:** This Limited Warranty provides coverage for three (3) years from the date the product is first sold to a recreational use retail purchaser, or the date on which the product is first put into service, whichever occurs first.

Commercial users of these products receive warranty coverage of one (1) year from the date of first retail sale, or one (1) year from the date on which the product was first put into service, whichever occurs first. Commercial use is defined as any work or employment related use of the product, or any use of the product which generates income, for any part of the warranty period, even if the product is only occasionally used for such purposes.

The repair or replacement of parts, or the performance of service under this warranty, does not extend the life of this warranty beyond its original expiration date. Unexpired warranty coverage can be transferred from one recreational use customer to a subsequent recreational use customer upon proper reregistration of the product. Unexpired warranty coverage cannot be transferred either to or from a commercial use customer.

Warranty coverage may be terminated for used repossessed product; or product purchased at auction, from a salvage yard, or from an insurance company.

**CONDITIONS THAT MUST BE MET IN ORDER TO OBTAIN WARRANTY COVERAGE:** Warranty coverage is available only to retail customers that purchase from a Dealer authorized by Mercury Marine to distribute the product in the country in which the sale occurred, and then only after the Mercury Marine specified predelivery inspection process is completed and documented. Warranty coverage becomes available upon proper registration of the product by the authorized dealer. Inaccurate warranty registration information regarding recreational use, or subsequent change of use from recreational to commercial (unless properly reregistered) may void the warranty at the sole discretion of Mercury Marine. Routine maintenance outlined in the Operation and Maintenance Manual must be timely performed in order to maintain warranty coverage. Mercury Marine reserves the right to make warranty coverage contingent upon proof of proper maintenance.

# WARRANTY INFORMATION

**WHAT MERCURY WILL DO:** Mercury's sole and exclusive obligation under this warranty is limited to, at our option, repairing a defective part, replacing such part or parts with new or Mercury Marine certified remanufactured parts, or refunding the purchase price of the Mercury product. Mercury reserves the right to improve or modify products from time to time without assuming an obligation to modify products previously manufactured.

**HOW TO OBTAIN WARRANTY COVERAGE:** The customer must provide Mercury with a reasonable opportunity to repair, and reasonable access to the product for warranty service. Warranty claims shall be made by delivering the product for inspection to a Mercury dealer authorized to service the product. If purchaser cannot deliver the product to such a dealer, written notice must be given to Mercury. We will then arrange for the inspection and any covered repair. Purchaser, in that case, shall pay for all related transportation charges and/or travel time. If the service provided is not covered by this warranty, purchaser shall pay for all related labor and material, and any other expenses associated with that service. Purchaser shall not, unless requested by Mercury, ship the product or parts of the product directly to Mercury. Proof of registered ownership must be presented to the dealer at the time warranty service is requested in order to obtain coverage.

# WARRANTY INFORMATION

**WHAT IS NOT COVERED:** This limited warranty does not cover routine maintenance items, tune-ups, adjustments, normal wear and tear, damage caused by abuse, abnormal use, use of a propeller or gear ratio that does not allow the engine to run in its recommended wide-open throttle RPM range (see the Operation and Maintenance Manual), operation of the product in a manner inconsistent with the recommended operation/duty cycle section of the Operation and Maintenance Manual, neglect, accident, submersion, improper installation (proper installation specifications and techniques are set forth in the installation instructions for the product), improper service, use of an accessory or part not manufactured or sold by us, jet pump impellers and liners, operation with fuels, oils, or lubricants which are not suitable for use with the product (see the Operation and Maintenance Manual), alteration or removal of parts, water entering the engine through the fuel intake, air intake or exhaust system, or damage to the product from insufficient cooling water caused by blockage of the cooling system by a foreign body, running the engine out of water, mounting the engine too high on the transom, or running the boat with the engine trimmed out too far. Use of the product for racing or other competitive activity, or operating with a racing type lower unit, at any point, even by a prior owner of the product, voids the warranty.

Expenses related to haul-out, launch, towing, storage, telephone, rental, inconvenience, slip fees, insurance coverage, loan payments, loss of time, loss of income, or any other type of incidental or consequential damages are not covered by this warranty. Also, expenses associated with the removal and/or replacement of boat partitions or material caused by boat design for access to the product are not covered by this warranty.

No individual or entity, including Mercury Marine authorized dealers, has been given authority by Mercury Marine to make any affirmation, representation, or warranty regarding the product, other than those contained in this limited warranty, and if made, shall not be enforceable against Mercury Marine.



# WARRANTY INFORMATION

For additional information regarding events and circumstances covered by this warranty, and those that are not, see the Warranty Coverage section of the Operation and Maintenance Manual, incorporated by reference into this warranty.

## DISCLAIMERS AND LIMITATIONS:

THE IMPLIED WARRANTIES OF MERCHANTABILITY AND FITNESS FOR A PARTICULAR PURPOSE ARE EXPRESSLY DISCLAIMED. TO THE EXTENT THAT THEY CANNOT BE DISCLAIMED, THE IMPLIED WARRANTIES ARE LIMITED IN DURATION TO THE LIFE OF THE EXPRESS WARRANTY. INCIDENTAL AND CONSEQUENTIAL DAMAGES ARE EXCLUDED FROM COVERAGE UNDER THIS WARRANTY. SOME STATES/COUNTRIES DO NOT ALLOW FOR THE DISCLAIMERS, LIMITATIONS AND EXCLUSIONS IDENTIFIED ABOVE, AS A RESULT, THEY MAY NOT APPLY TO YOU. THIS WARRANTY GIVES YOU SPECIFIC LEGAL RIGHTS, AND YOU MAY ALSO HAVE OTHER LEGAL RIGHTS WHICH VARY FROM STATE TO STATE AND COUNTRY TO COUNTRY.

## FourStroke Outboard Limited Warranty

### EUROPE AND CONFEDERATION OF INDEPENDENT STATES

Outside Europe and Confederation of Independent States - check with local distributor.

**WHAT IS COVERED:** Mercury Marine warrants its new products to be free of defects in material and workmanship during the period described below.

# WARRANTY INFORMATION

**DURATION OF COVERAGE:** This Limited Warranty provides coverage for two (2) years from the date the product is first sold to a recreational use retail purchaser, or the date on which the product is first put into service, whichever occurs first.

Commercial users of these products receive warranty coverage of one (1) year from the date of first retail sale, or one (1) year from the date in which the product was first put into service, whichever occurs first. Commercial use is defined as any work or employment related use of the product, or any use of the product which generates income, for any part of the warranty period, even if the product is only occasionally used for such purposes.

The repair or replacement of parts, or the performance of service under this warranty, does not extend the life of this warranty beyond its original expiration date. Unexpired warranty coverage can be transferred from one recreational use customer to a subsequent recreational use customer upon proper reregistration of the product. Unexpired warranty coverage cannot be transferred either to or from a commercial use customer.

Warranty coverage may be terminated for used or repossessed product; or product purchased at auction, from a salvage yard, or from an insurance company.

**CONDITIONS THAT MUST BE MET IN ORDER TO OBTAIN WARRANTY COVERAGE:** Warranty coverage is available only to retail customers that purchase from a Dealer authorized by Mercury Marine to distribute the product in the country in which the sale occurred, and then only after the Mercury Marine specified predelivery inspection process is completed and documented. Warranty coverage becomes available upon proper registration of the product by the authorized dealer. Routine maintenance outlined in the Operation and Maintenance Manual must be timely performed in order to maintain warranty coverage. Mercury Marine reserves the right to make future warranty coverage contingent on proof of proper maintenance.

# WARRANTY INFORMATION

**WHAT MERCURY WILL DO:** Mercury's sole and exclusive obligation under this warranty is limited to, at our option, repairing a defective part, replacing such part or parts with new or Mercury Marine certified remanufactured parts, or refunding the purchase price of the Mercury product. Mercury reserves the right to improve or modify products from time to time without assuming an obligation to modify products previously manufactured.

**HOW TO OBTAIN WARRANTY COVERAGE:** The customer must provide Mercury with a reasonable opportunity to repair, and reasonable access to the product for warranty service. Warranty claims shall be made by delivering the product for inspection to a Mercury dealer authorized to service the product. If purchaser cannot deliver the product to such a dealer, written notice must be given to Mercury. We will then arrange for the inspection and any covered repair. Purchaser in that case shall pay for all related transportation charges and/or travel time. If the service provided is not covered by this warranty, purchaser shall pay for all related labor and material, and any other expenses associated with that service. Purchaser shall not, unless requested by Mercury, ship the product or parts of the product directly to Mercury. Proof of registered ownership must be presented to the dealer at the time warranty service is requested in order to obtain coverage.

# WARRANTY INFORMATION

**WHAT IS NOT COVERED:** This limited warranty does not cover routine maintenance items, tune-ups, adjustments, normal wear and tear, damage caused by abuse, abnormal use, use of a propeller or gear ratio that does not allow the engine to run in its recommended wide-open throttle RPM range (see the Operation and Maintenance Manual), operation of the product in a manner inconsistent with the recommended operation/duty cycle section of the Operation and Maintenance Manual, neglect, accident, submersion, improper installation (proper installation specifications and techniques are set forth in the installation instructions for the product), improper service, use of an accessory or part not manufactured or sold by us, jet pump impellers and liners, operation with fuels, oils or lubricants which are not suitable for use with the product (see the Operation and Maintenance Manual), alteration or removal of parts, or water entering the engine through the fuel intake, air intake or exhaust system, or damage to the product from insufficient cooling water caused by blockage of the cooling system by a foreign body, running the engine out of water, mounting the engine too high on the transom, or running the boat with the engine trimmed out too far. Use of the product for racing or other competitive activity, or operating with a racing type lower unit, at any point, even by a prior owner of the product, voids the warranty.

Expenses related to haul out, launch, towing, storage, telephone, rental, inconvenience, slip fees, insurance coverage, loan payments, loss of time, loss of income, or any other type of incidental or consequential damages are not covered by this warranty. Also, expenses associated with the removal and/or replacement of boat partitions or material caused by boat design for access to the product are not covered by this warranty.

No individual or entity, including Mercury Marine authorized dealers, has been given authority by Mercury Marine to make any affirmation, representation or warranty regarding the product, other than those contained in this limited warranty, and if made, shall not be enforceable against Mercury Marine.

# WARRANTY INFORMATION

For additional information regarding events and circumstances covered by this warranty, and those that are not, see the Warranty Coverage section of the Operation and Maintenance Manual, incorporated by reference into this warranty.

## DISCLAIMERS AND LIMITATIONS:

THE IMPLIED WARRANTIES OF MERCHANTABILITY AND FITNESS FOR A PARTICULAR PURPOSE ARE EXPRESSLY DISCLAIMED. TO THE EXTENT THAT THEY CANNOT BE DISCLAIMED, THE IMPLIED WARRANTIES ARE LIMITED IN DURATION TO THE LIFE OF THE EXPRESS WARRANTY. INCIDENTAL AND CONSEQUENTIAL DAMAGES ARE EXCLUDED FROM COVERAGE UNDER THIS WARRANTY. SOME STATES/COUNTRIES DO NOT ALLOW FOR THE DISCLAIMERS, LIMITATIONS AND EXCLUSIONS IDENTIFIED ABOVE, AS A RESULT, THEY MAY NOT APPLY TO YOU. THIS WARRANTY GIVES YOU SPECIFIC LEGAL RIGHTS, AND YOU MAY ALSO HAVE OTHER LEGAL RIGHTS WHICH VARY FROM STATE TO STATE AND COUNTRY TO COUNTRY.

## FourStroke Outboard Limited Warranty

### MIDDLE-EAST AND AFRICA

**WHAT IS COVERED:** Mercury Marine warrants its new Outboard and Jet Products to be free of defects in material and workmanship during the period described below.

# WARRANTY INFORMATION

**DURATION OF COVERAGE:** This Limited Warranty provides coverage for one (1) year from the date the product is first sold to a recreational use retail purchaser, or the date on which the product is first put into service, whichever occurs first.

Commercial users of these products receive warranty coverage of one (1) years from the date of first retail sale, or one (1) year from the date on which the product was first put into service, whichever occurs first. Commercial use is defined as any work or employment related use of the product, or any use of the product which generates income, for any part of the warranty period, even if the product is only occasionally used for such purposes. The repair or replacement of parts, or the performance of service under this warranty, does not extend the life of this warranty beyond its original expiration date. Unexpired warranty coverage can be transferred from one recreational use customer to a subsequent recreational use customer upon proper reregistration of the product. Unexpired warranty coverage cannot be transferred either to or from a commercial use customer.

**CONDITIONS THAT MUST BE MET IN ORDER TO OBTAIN WARRANTY COVERAGE:** Warranty coverage is available only to retail customers that purchase from a Dealer authorized by Mercury Marine to distribute the product in the country in which the sale occurred, and then only after the Mercury Marine specified predelivery inspection process is completed and documented. Warranty coverage becomes available upon proper registration of the product by the authorized dealer. Routine maintenance outlined in the Operation and Maintenance Manual must be timely performed in order to maintain warranty coverage. Mercury Marine reserves the right to make warranty coverage contingent on proof of proper maintenance.

**WHAT MERCURY WILL DO:** Mercury's sole and exclusive obligation under this warranty is limited to, at our option, repairing a defective part, replacing such part or parts with new or Mercury Marine certified remanufactured parts, or refunding the purchase price of the Mercury product. Mercury reserves the right to improve or modify products from time to time without assuming an obligation to modify products previously manufactured.

# WARRANTY INFORMATION

**HOW TO OBTAIN WARRANTY COVERAGE:** The customer must provide Mercury with a reasonable opportunity to repair, and reasonable access to the product for warranty service. Warranty claims shall be made by delivering the product for inspection to a Mercury dealer authorized to service the product. If purchaser cannot deliver the product to such a dealer, written notice must be given to Mercury. We will then arrange for the inspection and any covered repair. Purchaser in that case shall pay for all related transportation charges and/or travel time. If the service provided is not covered by this warranty, purchaser shall pay for all related labor and material, and any other expenses associated with that service. Purchaser shall not, unless requested by Mercury, ship the product or parts of the product directly to Mercury. Proof of registered ownership must be presented to the dealer at the time warranty service is requested in order to obtain coverage.

**WHAT IS NOT COVERED:** This limited warranty does not cover routine maintenance items, tune-ups, adjustments, normal wear and tear, damage caused by abuse, abnormal use, use of a propeller or gear ratio that does not allow the engine to run in its recommended wide-open throttle RPM range (see the Operation and Maintenance Manual), operation of the product in a manner inconsistent with the recommended operation/duty cycle section of the Operation and Maintenance Manual, neglect, accident, submersion, improper installation (proper installation specifications and techniques are set forth in the installation instructions for the product), improper service, use of an accessory or part not manufactured or sold by us, jet pump impellers and liners, operation with fuels, oils or lubricants which are not suitable for use with the product (see the Operation and Maintenance Manual), alteration or removal of parts, or water entering the engine through the fuel intake, air intake or exhaust system, or damage to the product from insufficient cooling water caused by blockage of the cooling system by foreign body, running the engine out of water, mounting the engine too high on the transom, or running the boat with the engine trimmed out too far.

# WARRANTY INFORMATION

Use of the product for racing or other competitive activity, or operating with a racing type lower unit, at any point, even by a prior owner of the product, voids the warranty.

Expenses related to haul out, launch, towing, storage, telephone, rental, inconvenience, slip fees, insurance coverage, loan payments, loss of time, loss of income, or any other type of incidental or consequential damages are not covered by this warranty. Also, expenses associated with the removal and/or replacement of boat partitions or material caused by boat design for access to the product are not covered by this warranty.

No individual or entity, including Mercury Marine authorized dealers, has been given authority by Mercury Marine to make any affirmation, representation or warranty regarding the product, other than those contained in this limited warranty, and if made, shall not be enforceable against Mercury Marine.

For additional information regarding events and circumstances covered by this warranty, and those that are not, see the Warranty Coverage section of the Operation and Maintenance Manual, incorporated by reference into this warranty.

<b>DISCLAIMERS AND LIMITATIONS:</b>
<b>THE IMPLIED WARRANTIES OF MERCHANTABILITY AND FITNESS FOR A PARTICULAR PURPOSE ARE EXPRESSLY DISCLAIMED. TO THE EXTENT THAT THEY CANNOT BE DISCLAIMED, THE IMPLIED WARRANTIES ARE LIMITED IN DURATION TO THE LIFE OF THE EXPRESS WARRANTY. INCIDENTAL AND CONSEQUENTIAL DAMAGES ARE EXCLUDED FROM COVERAGE UNDER THIS WARRANTY. SOME STATES/COUNTRIES DO NOT ALLOW FOR THE DISCLAIMERS, LIMITATIONS AND EXCLUSIONS IDENTIFIED ABOVE, AS A RESULT, THEY MAY NOT APPLY TO YOU. THIS WARRANTY GIVES YOU SPECIFIC LEGAL RIGHTS, AND YOU MAY ALSO HAVE OTHER LEGAL RIGHTS WHICH VARY FROM STATE TO STATE AND COUNTRY TO COUNTRY.</b>



# WARRANTY INFORMATION

## 3 Year Limited Warranty Against Corrosion

**WHAT IS COVERED:** Mercury Marine warrants that each new Mercury, Mariner, Mercury Racing, Sport Jet, M<sup>2</sup> Jet Drive, Tracker by Mercury Marine Outboard, Mercury MerCruiser Inboard or Sterndrive Engine (Product) will not be rendered inoperative as a direct result of corrosion for the period of time described below.

**DURATION OF COVERAGE:** This limited corrosion warranty provides coverage for three (3) years from either the date the product is first sold, or the date on which the product is first put into service, whichever occurs first. The repair or replacement of parts, or the performance of service under this warranty, does not extend the life of this warranty beyond its original expiration date. Unexpired warranty coverage can be transferred to subsequent (noncommercial use) purchaser upon proper reregistration of the product.

**CONDITIONS THAT MUST BE MET IN ORDER TO OBTAIN WARRANTY COVERAGE:** Warranty coverage is available only to retail customers that purchase from a Dealer authorized by Mercury Marine to distribute the product in the country in which the sale occurred, and then only after the Mercury Marine specified predelivery inspection process is completed and documented. Warranty coverage becomes available upon proper registration of the product by the authorized dealer. Corrosion prevention devices specified in the Operation and Maintenance Manual must be in use on the boat, and routine maintenance outlined in the Operation and Maintenance Manual must be timely performed (including, without limitation, the replacement of sacrificial anodes, use of specified lubricants, and touch-up of nicks and scratches) in order to maintain warranty coverage. Mercury Marine reserves the right to make warranty coverage contingent upon proof of proper maintenance.

# WARRANTY INFORMATION

**WHAT MERCURY WILL DO:** Mercury's sole and exclusive obligation under this warranty is limited to, at our option, repairing a corroded part, replacing such part or parts with new or Mercury Marine certified remanufactured parts, or refunding the purchase price of the Mercury product. Mercury reserves the right to improve or modify products from time to time without assuming an obligation to modify products previously manufactured.

**HOW TO OBTAIN WARRANTY COVERAGE:** The customer must provide Mercury with a reasonable opportunity to repair, and reasonable access to the product for warranty service. Warranty claims shall be made by delivering the product for inspection to a Mercury dealer authorized to service the product. If purchaser cannot deliver the product to such a dealer, written notice must be given to Mercury. We will then arrange for the inspection and any covered repair. Purchaser, in that case, shall pay for all related transportation charges and/or travel time. If the service provided is not covered by this warranty, purchaser shall pay for all related labor and material, and any other expenses associated with that service. Purchaser shall not, unless requested by Mercury, ship the product or parts of the product directly to Mercury. Proof of registered ownership must be presented to the dealer at the time warranty service is requested in order to obtain coverage.

**WHAT IS NOT COVERED:** This limited warranty does not cover electrical system corrosion; corrosion resulting from damage, corrosion which causes purely cosmetic damage, abuse, or improper service; corrosion to accessories, instruments, steering systems; corrosion to factory installed jet drive unit; damage due to marine growth; product sold with less than a one year limited Product warranty; replacement parts (parts purchased by customer); products used in a commercial application. Commercial use is defined as any work or employment related use of the product, or any use of the product which generates income, for any part of the warranty period, even if the product is only occasionally used for such purposes.

## WARRANTY INFORMATION

Corrosion damage caused by stray electrical currents (onshore power connections, nearby boats, submerged metal) is not covered by this corrosion warranty and should be protected against by the use of a corrosion protection system, such as the Mercury Precision Parts or Quicksilver MerCathode system and/or Galvanic Isolator. Corrosion damage caused by improper application of copper base antifouling paints is also not covered by this limited warranty. If antifouling protection is required, Tri-Butyl-Tin-Adipate (TBTA) base antifouling paints are recommended on Outboard and MerCruiser boating applications. In areas where TBTA base paints are prohibited by law, copper base paints can be used on the hull and transom. Do not apply paint to the outboard or MerCruiser product. In addition, care must be taken to avoid an electrical interconnection between the warranted product and the paint. For MerCruiser product, an unpainted gap of at least 38 mm (1.5 in.) should be left around the transom assembly. Refer to the Operation and Maintenance Manual for additional details.

For additional information regarding events and circumstances covered by this warranty, and those that are not, see the Warranty Coverage section of the Operation and Maintenance Manual, incorporated by reference into this warranty.

### **DISCLAIMERS AND LIMITATIONS:**

**THE IMPLIED WARRANTIES OF MERCHANTABILITY AND FITNESS FOR A PARTICULAR PURPOSE ARE EXPRESSLY DISCLAIMED. TO THE EXTENT THAT THEY CANNOT BE DISCLAIMED, THE IMPLIED WARRANTIES ARE LIMITED IN DURATION TO THE LIFE OF THE EXPRESS WARRANTY. INCIDENTAL AND CONSEQUENTIAL DAMAGES ARE EXCLUDED FROM COVERAGE UNDER THIS WARRANTY. SOME STATES/COUNTRIES DO NOT ALLOW FOR THE DISCLAIMERS, LIMITATIONS AND EXCLUSIONS IDENTIFIED ABOVE, AS A RESULT, THEY MAY NOT APPLY TO YOU. THIS WARRANTY GIVES YOU SPECIFIC LEGAL RIGHTS, AND YOU MAY ALSO HAVE OTHER LEGAL RIGHTS WHICH VARY FROM STATE TO STATE AND COUNTRY TO COUNTRY.**

# WARRANTY INFORMATION

## Warranty Coverage and Exclusions

The purpose of this section is to help eliminate some of the more common misunderstandings regarding warranty coverage. The following information explains some of the types of services that are not covered by warranty. The provisions set forth following have been incorporated by reference into the Three Year Limited Warranty Against Corrosion Failure, the International Limited Outboard Warranty, and the United States and Canada Limited Outboard Warranty.

Keep in mind that warranty covers repairs that are needed within the warranty period because of defects in material and workmanship. Installation errors, accidents, normal wear, and a variety of other causes that affect the product are not covered.

Warranty is limited to defects in material or workmanship, but only when the consumer sale is made in the country to which distribution is authorized by us.

Should you have any questions concerning warranty coverage, contact your authorized dealer. They will be pleased to answer any questions that you may have.

### GENERAL EXCLUSIONS FROM WARRANTY

1. Minor adjustments and tune-ups, including checking, cleaning, or adjusting spark plugs, ignition components, carburetor settings, filters, belts, controls, and checking lubrication made in connection with normal services.
2. Factory installed jet drive units - Specific parts excluded from the warranty are: the jet drive impeller and jet drive liner damaged by impact or wear, and water damaged driveshaft bearings as a result of improper maintenance.
3. Damage caused by neglect, lack of maintenance, accident, abnormal operation, or improper installation or service.
4. Haul-out, launch, towing charges, removal and/or replacement of boat partitions or material because of boat design for necessary access to the product, all related transportation charges and/or travel time, etc. Reasonable access must be provided to the product for warranty service. Customer must deliver product to an authorized dealer.

# WARRANTY INFORMATION

5. Additional service work requested by customer other than that necessary to satisfy the warranty obligation.
6. Labor performed by other than an authorized dealer may be covered only under the following circumstances: when performed on emergency basis (providing there are no authorized dealers in the area who can perform the work required or have no facilities to haul-out, etc., and prior factory approval has been given to have the work performed at this facility).
7. All incidental and/or consequential damages (storage charges, telephone or rental charges of any type, inconvenience or loss of time or income) are the owner's responsibility.
8. Use of other than Mercury Precision or Quicksilver parts when making warranty repairs.
9. Oils, lubricants, or fluids changed as a matter of normal maintenance is customer's responsibility unless loss or contamination of same is caused by product failure that would be eligible for warranty consideration.
10. Participating in or preparing for racing or other competitive activity or operating with a racing type lower unit.
11. Engine noise does not necessarily indicate a serious engine problem. If diagnosis indicates a serious internal engine condition which could result in a failure, condition responsible for noise should be corrected under the warranty.
12. Lower unit and/or propeller damage caused by striking a submerged object is considered a marine hazard.
13. Water entering engine through the fuel intake, air intake, or exhaust system or submersion.
14. Failure of any parts caused by lack of cooling water, which results from starting motor out of water, foreign material blocking inlet holes, motor being mounted too high, or trimmed too far out.
15. Use of fuels and lubricants which are not suitable for use with or on the product. Refer to the **Maintenance** section.

# WARRANTY INFORMATION

16. Our limited warranty does not apply to any damage to our products caused by the installation or use of parts and accessories which are not manufactured or sold by us. Failures which are not related to the use of those parts or accessories are covered under warranty if they otherwise meet the terms of the limited warranty for that product.

## U.S. EPA Emissions Limited Warranty

Consistent with the obligations created by 40 CFR Part 1045, Subpart B, Mercury Marine provides a five year or 175 hours of engine use, whichever occurs first, to the retail customer, that the engine is designed, built, and equipped so as to conform at the time of sale with applicable regulations under section 213 of the Clean Air Act, and that the engine is free from defects in materials and workmanship which cause the engine to fail to conform with applicable regulations. This emission-related warranty covers all the components listed in the **Emission Control System Components**.

## Emission Control System Components

The EPA and California emission-related warranty covers all the following list of components:

### COMPONENTS OF THE EMISSIONS CONTROL SYSTEM:

1. Fuel metering system
  - a. Carburetor and internal parts (and/or pressure regulator or fuel injection system)
  - b. Cold start enrichment system
  - c. Intake valves
2. Air induction system
  - a. Intake manifold
  - b. Turbocharger or supercharger systems (where applicable)
3. Ignition system
  - a. Spark plugs
  - b. Magneto or electronic ignition system
  - c. Spark advance/retard system

# WARRANTY INFORMATION

- d. Ignition coil and/or control module
- e. Ignition wires
- 4. Lubrication system (4-Stroke engines excluded)
  - a. Oil pump and internal parts
  - b. Oil injectors
  - c. Oil meter
- 5. Exhaust system
  - a. Exhaust manifold
  - b. Exhaust valves
- 6. Miscellaneous items used in above systems
  - a. Hoses, clamps, fittings, tubing, sealing gaskets or devices, and mounting hardware
  - b. Pulleys, belts, and idlers
  - c. Vacuum, temperature, check and time sensitive valves and switches
  - d. Electronic controls

The emission-related warranty does not cover components whose failure would not increase an engine's emissions on any regulated pollutant.

## California Emissions Limited Warranty

The California Air Resources Board has promulgated air emission regulations for outboard engines. The regulations apply to all outboard engines sold to retail consumers in California, and which were manufactured for the 2001 model year and later. Mercury Marine, in compliance with those regulations, provides this limited warranty for the emission control systems (see the components listed in the **Emission Control System Components**), and further warrants that the outboard engine was designed, built, and equipped to conform with all applicable regulations adopted by the California Air Resources Board pursuant to its authority in Chapters 1 and 2, Part 5, Division 26 of the Health and Safety Code. For information regarding the limited warranty for the nonemission-related components of the outboard, please see the limited warranty statement for your outboard.

# WARRANTY INFORMATION

**WHAT IS COVERED:** Mercury Marine warrants the components of the emissions control systems (see the components listed in the **Emission Control System Components**) of its new, 2001 model year and later outboards, sold by a California dealer to retail customers residing in California, to be free from defects in material or workmanship, that cause the failure of a warranted part to be identical in all material respects to that part as described in the application of Mercury Marine for certification from the California Air Resources Board, for the period of time, and under the conditions, identified below. The cost to diagnose a warranty failure is covered under the warranty (if the warranty claim is approved). Damage to other engine components caused by the failure of a warranted part will also be repaired under warranty.

**DURATION OF COVERAGE:** This limited warranty provides coverage for the components of the emissions control systems of new, 2001 model year and later outboards, sold to retail customers in California for four (4) years from either the date the product is first sold, or first put into service, whichever occurs first, or the accumulation of 250 hours of engine operation (as determined by the engine's hour meter, if any). Emission-related normal maintenance items such as spark plugs and filters, that are on the warranted parts list, are warranted up to their first required replacement interval only. Refer to **Emission Control System Components and Maintenance Schedule**. The repair or replacement of parts, or the performance of service under this warranty, does not extend the life of this warranty beyond its original expiration date. Unexpired warranty coverage can be transferred to a subsequent purchaser. (See instructions on transfer of warranty.)



# WARRANTY INFORMATION

**HOW TO OBTAIN WARRANTY COVERAGE:** The customer must provide Mercury with a reasonable opportunity to repair and reasonable access to the product for warranty service. Warranty claims shall be made by delivering the product for inspection to a Mercury dealer authorized to service the product. If purchaser cannot deliver the product to such a dealer, please notify Mercury Marine and Mercury will then arrange for the inspection and any covered repair. Purchaser, in that case, shall pay for all related transportation charges and/or travel time. If the service provided is not covered by this warranty, purchaser shall pay for all related labor and material, and any other expenses associated with that service. Purchaser shall not, unless requested by Mercury, ship the product or parts of the product directly to Mercury.

**WHAT MERCURY WILL DO:** Mercury Marine's sole and exclusive obligation under this warranty is limited to, at our expense and at our option, repairing or replacing defective parts with new or Mercury Marine certified remanufactured parts, or refunding the purchase price of the Mercury product. Mercury reserves the right to improve or modify products from time to time without assuming an obligation to modify products previously manufactured.

**WHAT IS NOT COVERED:** This limited warranty does not cover routine maintenance items, tune-ups, adjustments, normal wear and tear, damage caused by abuse, abnormal use, use of a propeller or gear ratio that does not allow the engine to run in its recommended wide-open throttle RPM range (see **General Information - Specifications**), operation of the product in a manner inconsistent with the recommended operation procedures, neglect, accident, submersion, improper installation (proper installation specifications and techniques are set forth in the installation instructions for the product), improper service, jet pump impellers and liners, operation with fuels, oils, or lubricants which are not suitable for use with the product (see **Fuel and Oil**), alteration or removal of parts.

# WARRANTY INFORMATION

Expenses related to haul-out, launch, towing, storage, telephone, rental, inconvenience, slip fees, insurance coverage, loan payments, loss of time, loss of income, or any other type of incidental or consequential damages are not covered by this warranty. Also, expenses associated with the removal and/or replacement of boat partitions or material caused by boat design for access to the product are not covered by this warranty.

Nonwarranty maintenance, replacement, or repair of emission control devices and systems may be performed by any marine engine repair establishment or individual. The use of non-Mercury parts for nonwarranty maintenance or repairs will not be grounds for disallowing other warranty work. The use of add-on (as defined at section 1900 (b)(1) and (b)(10) of Title 13 of the California Code of Regulations) or modified parts not exempted by the California Air Resources Board may be grounds for disallowing a warranty claim, at the discretion of Mercury Marine. Failures of warranted parts caused by the use of a nonexempted add-on or modified part will not be covered.

## DISCLAIMERS AND LIMITATIONS

THE IMPLIED WARRANTIES OF MERCHANTABILITY AND FITNESS FOR A PARTICULAR PURPOSE ARE EXPRESSLY DISCLAIMED. TO THE EXTENT THAT THEY CANNOT BE DISCLAIMED, THE IMPLIED WARRANTIES ARE LIMITED IN DURATION TO THE LIFE OF THE EXPRESS WARRANTY. INCIDENTAL AND CONSEQUENTIAL DAMAGES ARE EXCLUDED FROM COVERAGE UNDER THIS WARRANTY. SOME STATES/COUNTRIES DO NOT ALLOW FOR THE DISCLAIMERS, LIMITATIONS AND EXCLUSIONS IDENTIFIED ABOVE, AS A RESULT, THEY MAY NOT APPLY TO YOU. THIS WARRANTY GIVES YOU SPECIFIC LEGAL RIGHTS, AND YOU MAY ALSO HAVE OTHER LEGAL RIGHTS WHICH VARY FROM STATE TO STATE AND COUNTRY TO COUNTRY.

If you have any questions regarding your warranty rights and responsibilities, you should contact Mercury Marine at 1-920-929-5040.

# WARRANTY INFORMATION

## California Air Resources Board Explanation of Your California Emission Control Warranty Statement

**YOUR WARRANTY RIGHTS AND OBLIGATIONS:** The California Air Resources Board is pleased to explain the emission control system warranty on your 2001 model year and later outboard engine. In California, new outboard engines must be designed, built, and equipped to meet the State's stringent anti-smog standards. Mercury Marine must warrant the emission control system on your outboard engine for the periods of time listed below, provided there has been no abuse, neglect, or improper maintenance of your outboard engine.

Your emission control system may include parts such as the carburetor or fuel injection system, the ignition system, and catalytic converter. Also included may be hoses, belts, connectors, and other emission-related assemblies.

Where a warrantable condition exists, Mercury Marine will repair your outboard engine at no cost to you, including diagnosis, parts, and labor.

**MANUFACTURER'S WARRANTY COVERAGE:** Select emission control parts from model year 2001 and later outboard engines are warranted for four (4) years, or for 250 hours of use, whichever occurs first. However, warranty coverage based on the hourly period is only permitted for outboard engines and personal watercraft equipped with appropriate hour meters or their equivalent. If any emission-related part on your engine is defective under warranty, the part will be repaired or replaced by Mercury Marine.

**OWNER'S WARRANTY RESPONSIBILITIES:** As the outboard engine owner, you are responsible for the performance of the required maintenance listed in the **Maintenance** section. Mercury Marine recommends that you retain all receipts covering maintenance on your outboard engine, but Mercury Marine cannot deny warranty solely for the lack of receipts or your failure to ensure the performance of all scheduled maintenance.

# WARRANTY INFORMATION

As the outboard engine owner, you should, however, be aware that Mercury Marine may deny you warranty coverage if your outboard engine or a part has failed due to abuse, neglect, improper maintenance, or unapproved modifications.

You are responsible for presenting your outboard to a Mercury dealer authorized to service the product as soon as a problem exists. The warranty repairs will be completed in a reasonable amount of time, not to exceed 30 days.

If you have any questions regarding your warranty rights and responsibilities, you should contact Mercury Marine at 1-920-929-5040.

## Emission Certification Star Label



Outboards are labeled on the cowl with one of the following star labels.

**The symbol for a cleaner marine engine means:**

**Cleaner air and water** - for a healthier lifestyle and environment.

**Better fuel economy** - burns up to 30–40 percent less gas and oil than conventional carbureted two-stroke engines, saving money and resources.

**Longer emission warranty** - protects consumer for worry-free operation.

 <p>The label features a black oval with a white star in the center. The word "LOW" is at the top, "EMISSION" is at the bottom, and "CALIFORNIA EMISSIONS STANDARDS" is written around the star. A small number "22531" is to the right.</p>	<p><b>One Star - Low Emission</b></p> <p>The One Star label identifies engines that meet the Air Resources Board's 2001 exhaust emissions standards. Engines meeting these standards have 75% lower emissions than conventional carbureted two-stroke engines. These engines are equivalent to the U.S. EPA's 2006 standards for marine engines.</p>
 <p>The label features a circular design with a white star in the center. The words "VERY LOW" are at the top, "EMISSION" is at the bottom, and "FOUR" is written across the star. A small number "42537" is to the right.</p>	<p><b>Two Stars - Very Low Emission</b></p> <p>The Two Star label identifies engines that meet the Air Resources Board's Personal Watercraft and Outboard marine engine 2004 exhaust emissions standards. Engines meeting these standards have 20% lower emissions than One Star - Low Emission engines.</p>

# WARRANTY INFORMATION



## Three Stars - Ultra Low Emission

The Three Star label identifies engines that meet the Air Resources Board's Personal Watercraft and Outboard marine engine 2008 exhaust emissions standards or the Sterndrive and Inboard marine engine 2003-2008 exhaust emission standards. Engines meeting these standards have 65% lower emissions than One Star - Low Emission engines.



## Four Stars - Super Ultra Low Emission

The Four Star label identifies engines that meet the Air Resources Board's Sterndrive and Inboard marine engine 2009 exhaust emission standards. Personal Watercraft and Outboard marine engines may also comply with these standards. Engines meeting these standards have 90% lower emissions than One Star - Low Emission engines.

# GENERAL INFORMATION

## Boater's Responsibilities

The operator (driver) is responsible for the correct and safe operation of the boat and safety of its occupants and general public. It is strongly recommended that each operator (driver) read and understand this entire manual before operating the outboard.

Be sure at least one additional person onboard is instructed in the basics of starting and operating the outboard and boat handling in case the driver is unable to operate the boat.

## Before Operating Your Outboard

Read this manual carefully. Learn how to operate your outboard properly. If you have any questions, contact your dealer.

Safety and operating information that is practiced, along with using good common sense, can help prevent personal injury and product damage.

This manual as well as safety labels posted on the outboard use the following safety alerts to draw your attention to special safety instructions that should be followed.

### **DANGER**

Indicates a hazardous situation which, if not avoided, will result in death or serious injury.

### **WARNING**

Indicates a hazardous situation which, if not avoided, could result in death or serious injury.

### **CAUTION**

Indicates a hazardous situation which, if not avoided, could result in minor or moderate injury.

### **NOTICE**

Indicates a situation which, if not avoided, could result in engine or major component failure.

# GENERAL INFORMATION

## Boat Horsepower Capacity

### WARNING

Exceeding the boat's maximum horsepower rating can cause serious injury or death. Overpowering the boat can affect boat control and flotation characteristics or break the transom. Do not install an engine that exceeds the boat's maximum power rating.

Do not overpower or overload your boat. Most boats will carry a required capacity plate indicating the maximum acceptable power and load as determined by the manufacturer following certain federal guidelines. If in doubt, contact your dealer or the boat manufacturer.

U.S. COAST GUARD CAPACITY	
MAXIMUM HORSEPOWER	XXX
MAXIMUM PERSON CAPACITY (POUNDS)	XXX
MAXIMUM WEIGHT CAPACITY	XXX

26777

## Lanyard Stop Switch

The purpose of a lanyard stop switch is to turn off the engine when the operator moves far enough away from the operator's position (as in accidental ejection from the operator's position) to activate the switch. Tiller handle outboards and some remote control units are equipped with a lanyard stop switch. A lanyard stop switch can be installed as an accessory - generally on the dashboard or side adjacent to the operator's position.

# GENERAL INFORMATION

The lanyard is a cord usually between 1220 and 1524 mm (4 and 5 feet) in length when stretched out, with an element on one end made to be inserted into the switch and a snap on the other end for attaching to the operator. The lanyard is coiled to make its at-rest condition as short as possible to minimize the likelihood of lanyard entanglement with nearby objects. Its stretched-out length is made to minimize the likelihood of accidental activation should the operator choose to move around in an area close to the normal operator's position. If it is desired to have a shorter lanyard, wrap the lanyard around the operator's wrist or leg, or tie a knot in the lanyard.

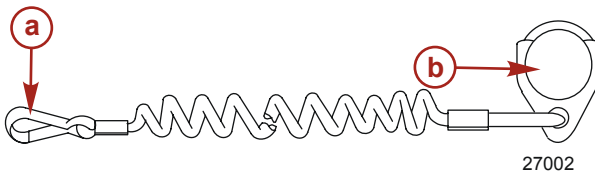

- a** - Lanyard cord
- b** - Lanyard stop switch

Read the following Safety Information before proceeding.

**Important Safety Information:** The purpose of a lanyard stop switch is to stop the engine when the operator moves far enough away from the operator's position to activate the switch. This would occur if the operator accidentally falls overboard or moves within the boat a sufficient distance from the operator's position. Falling overboard and accidental ejections are more likely to occur in certain types of boats such as low sided inflatables, bass boats, high performance boats, and light, sensitive handling fishing boats operated by a hand tiller. Falling overboard and accidental ejections are also likely to occur as a result of poor operating practices such as sitting on the back of the seat or gunwale at planing speeds, standing at planing speeds, sitting on elevated fishing boat decks, operating at planing speeds in shallow or obstacle infested waters, releasing your grip on a steering wheel or tiller handle that is pulling in one direction, drinking alcohol or consuming drugs, or daring, high speed boat maneuvers.



## GENERAL INFORMATION

While activation of the lanyard stop switch will stop the engine immediately, a boat will continue to coast for some distance depending upon the velocity and degree of any turn at shut down. However, the boat will not complete a full circle. While the boat is coasting, it can cause injury to anyone in the boat's path as seriously as the boat would when under power.

### WARNING

**If the operator falls out of the boat, stop the engine immediately to reduce the possibility of serious injury or death from being struck by the boat. Always properly connect the operator to the stop switch using a lanyard.**

We strongly recommend that other occupants be instructed on proper starting and operating procedures should they be required to operate the engine in an emergency (e.g. if the operator is accidentally ejected).

### WARNING

**Avoid serious injury or death from deceleration forces resulting from accidental or unintended stop switch activation. The boat operator should never leave the operator's station without first disconnecting the stop switch lanyard from the operator.**

Accidental or unintended activation of the switch during normal operation is also a possibility. This could cause any, or all, of the following potentially hazardous situations:

- Occupants could be thrown forward due to unexpected loss of forward motion - a particular concern for passengers in the front of the boat who could be ejected over the bow and possibly struck by the gearcase or propeller.
- Loss of power and directional control in heavy seas, strong current or high winds.
- Loss of control when docking.

# GENERAL INFORMATION

## Protecting People in the Water

### WHILE YOU ARE CRUISING

It is very difficult for a person standing or floating in the water to take quick action to avoid a boat heading in his/her direction, even at slow speed.



Always slow down and exercise extreme caution any time you are boating in an area where there might be people in the water.

Whenever a boat is moving (coasting) and the outboard gear shift is in neutral position, there is sufficient force by the water on the propeller to cause the propeller to rotate. This neutral propeller rotation can cause serious injury.

### WHILE BOAT IS STATIONARY

#### **WARNING**

A spinning propeller, a moving boat, or any solid device attached to the boat can cause serious injury or death to swimmers. Stop the engine immediately whenever anyone in the water is near your boat.

Shift outboard into neutral and shut off the engine before allowing people to swim or be in the water near your boat.

## Exhaust Emissions

### BE ALERT TO CARBON MONOXIDE POISONING

Carbon monoxide is present in the exhaust fumes of all internal combustion engines. This includes the outboards, sterndrives, and inboard engines that propel boats, as well as the generators that power various boat accessories. Carbon monoxide is a deadly gas that is odorless, colorless, and tasteless.

# GENERAL INFORMATION

Early symptoms of carbon monoxide poisoning which should not be confused with seasickness or intoxication, include headache, dizziness, drowsiness, and nausea.

## WARNING

Carbon monoxide poisoning can lead to unconsciousness, brain damage, or death. Keep the boat well ventilated while at rest or underway and avoid prolonged exposure to carbon monoxide.

### GOOD VENTILATION

Ventilate passenger area, open side curtains or forward hatches to remove fumes.

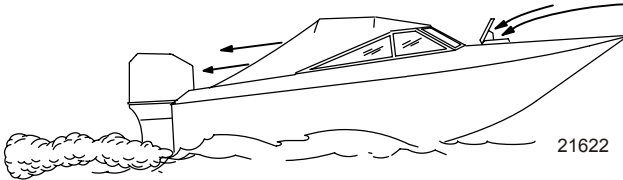

**Example of desired air flow through the boat**

### POOR VENTILATION

Under certain running and/or wind conditions, permanently enclosed or canvas enclosed cabins or cockpits with insufficient ventilation may draw in carbon monoxide. Install one or more carbon monoxide detectors in your boat.

Although the occurrence is rare, on a very calm day, swimmers and passengers in an enclosed area of a stationary boat that contains or is near a running engine may be exposed to a hazardous level of carbon monoxide.

# GENERAL INFORMATION

## WHILE BOAT IS STATIONARY

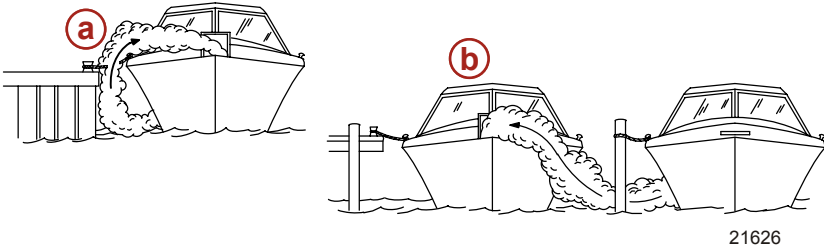

- a** - Running the engine when the boat is moored in a confined space
- b** - Mooring close to another boat that has its engine running

## WHILE BOAT IS MOVING



- a** - Running the boat with the trim angle of the bow too high
- b** - Running the boat with no forward hatches open

## Selecting Accessories for Your Outboard

Genuine Mercury Precision or Quicksilver Accessories have been specifically designed and tested for your outboard. These accessories are available from Mercury Marine dealers.

**IMPORTANT: Check with your dealer before installing accessories. The misuse of approved accessories or the use of nonapproved accessories can damage the product.**

Some accessories not manufactured or sold by Mercury Marine are not designed to be safely used with your outboard or outboard operating system. Acquire and read the installation, operation and maintenance manuals for all your selected accessories.

# GENERAL INFORMATION

## Safe Boating Suggestions

In order to safely enjoy the waterways, familiarize yourself with local and other governmental boating regulations and restrictions, and consider the following suggestions.

**Use flotation devices.** Have an approved personal flotation device of suitable size for each person aboard (it is the law) and have it readily accessible.

**Do not overload your boat.** Most boats are rated and certified for maximum load (weight) capacities (refer to your boat capacity plate). If in doubt, contact your dealer or the boat's manufacturer.

**Perform safety checks and required maintenance.** Follow a regular schedule and ensure that all repairs are properly made.

**Know and obey all nautical rules and laws of the waterways.**

Boat operators should complete a boating safety course. Courses are offered in the U.S.A. by 1) the U.S. Coast Guard Auxiliary, 2) the Power Squadron, 3) the Red Cross, and 4) your state boating law enforcement agency. Inquiries may be made to the Boating Hotline, 1-800-368-5647 or the Boat U.S. Foundation information number 1-800-336-BOAT.

**Make sure everyone in the boat is properly seated.** Do not allow anyone to sit or ride on any part of the boat that was not intended for such use. This includes the back of seats, gunwales, transom, bow, decks, raised fishing seats, any rotating fishing seat; or anywhere that an unexpected acceleration, sudden stopping, unexpected loss of boat control, or sudden boat movement could cause a person to be thrown overboard or into the boat.

**Never be under the influence of alcohol or drugs while boating (it is the law).** Alcohol or drug use impairs your judgment and greatly reduces your ability to react quickly.

**Prepare other boat operators.** Instruct at least one other person onboard in the basics of starting and operating the outboard, and boat handling, in case the driver becomes disabled or falls overboard.

**Passenger boarding.** Stop the engine whenever passengers are boarding, unloading, or are near the back (stern) of the boat. Just shifting the outboard into neutral is not sufficient.

## GENERAL INFORMATION

**Be alert.** The operator of the boat is responsible by law to maintain a proper lookout by sight and hearing. The operator must have an unobstructed view particularly to the front. No passengers, load, or fishing seats should block the operator's view when operating the boat above idle speed.

**Never drive your boat directly behind a water-skier in case the skier falls.** As an example, your boat traveling at 40 km/h (25 MPH) will overtake a fallen skier 61 m (200 ft) in front of you in 5 seconds.

**Watch fallen skiers.** When using your boat for waterskiing or similar activities, always keep a fallen or down skier on the operator's side of the boat while returning to assist the skier. The operator should always have the down skier in sight and never back up to the skier or anyone in the water.

**Report accidents.** Boat operators are required by law to file a Boating Accident Report with their state boating law enforcement agency when their boat is involved in certain boating accidents. A boating accident must be reported if 1) there is loss of life or probable loss of life, 2) there is personal injury requiring medical treatment beyond first aid, 3) there is damage to boats or other property where the damage value exceeds \$500.00, or 4) there is complete loss of the boat. Seek further assistance from local law enforcement.

# GENERAL INFORMATION

## Recording Serial Number

It is important to record this number for future reference. The serial number is located on the outboard as shown.

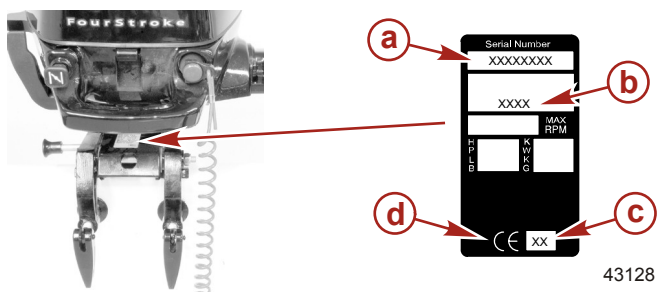

- a** - Serial number
- b** - Model designation
- c** - Year manufactured
- d** - Certified Europe Insignia (as applicable)

## Specifications

Models	2.5	3.5
Power	1.84 kw (2.5 hp)	2.57 kw (3.5 hp)
Full throttle RPM range	5000–6000	
Idle speed	1200 RPM in forward gear, 1300 RPM in neutral	
Number of cylinders	1	
Piston displacement	85.5 cc (5.21 cid)	
Cylinder bore	55 mm (2.16 in.)	
Piston stroke	36 mm (1.41 in.)	
Valve clearance (cold)		
Intake valve	0.06–0.14 mm (0.0024–0.0055 in.)	
Exhaust valve	0.11–0.19 mm (0.0043–0.0075 in.)	
Engine oil capacity	300 ml (10 fl oz)	
Recommended spark plug	NGK DCPR6E	
Spark plug gap	0.9 mm (0.035 in.)	
Gearcase lubricant capacity	180 ml (6.0 fl oz)	

# GENERAL INFORMATION

<b>Models</b>	<b>2.5</b>	<b>3.5</b>
Gear ratio	2.15:1	
Recommended gasoline	Refer to <b>Fuel and Oil</b>	
Recommended oil	Refer to <b>Fuel and Oil</b>	
Emission control system	Engine modification (EM)	
Sound at drivers ear (ICOMIA 39-94) bBA	79.8	
Tiller handle vibration (ICOMIA 38-94) m/s <sup>2</sup>	8.4	



# INSTALLATION

## Installing the Outboard

### BOAT TRANSOM HEIGHT REQUIREMENT

Measure the transom height of the boat. The anti-ventilation plate should be 25–50 mm (1–2 in.) below the bottom of the boat.

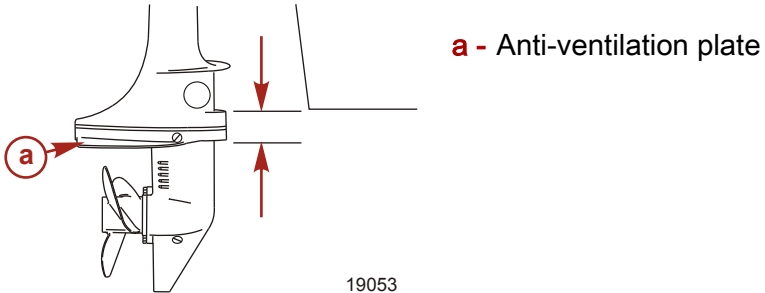

### INSTALLING THE OUTBOARD ON THE TRANSOM

1. Place the outboard on the centerline of the transom.

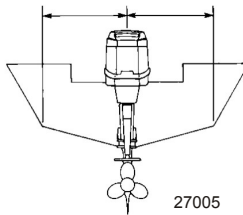

2. Tighten the transom clamp handles.

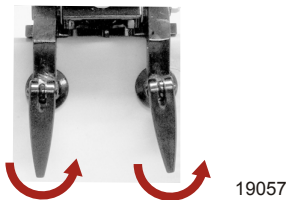

# TRANSPORTING

## Carrying, Storing, and Transporting the Outboard When Removed from Boat

With the outboard still in the water, close the fuel valve and run the engine until it stops. This will empty the fuel from the carburetor.

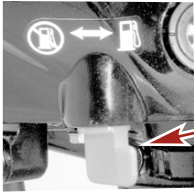

18843

- a** - Closed position
- b** - Open position
- c** - Fuel valve



Close the manual vent screw after the engine has stopped.

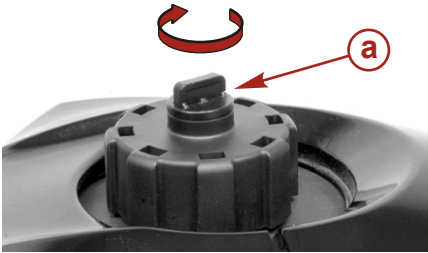

47362

- a** - Manual vent screw

Remove the outboard and hold it upright until the water is drained out. Keep the outboard in an upright position when carrying.

Carry, transport, or store the outboard only in the upright position, or with the tiller handle side facing up. These positions will prevent oil from draining out of the crankcase.

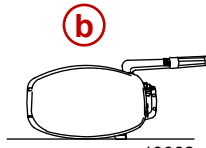
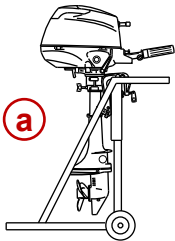

19062

- a** - Upright position
- b** - Tiller handle up position

# TRANSPORTING

Never carry, store, or transport the outboard in these positions. Engine damage could result from oil draining out of the crankcase.

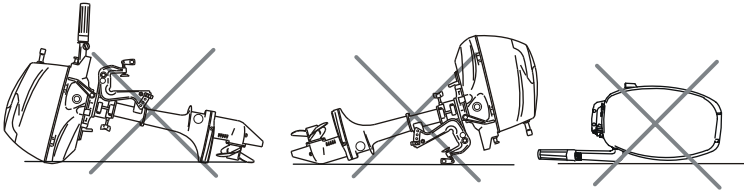

19063

## Trailing the Boat

**IMPORTANT:** The tilt lock mechanism is not intended to support the outboard in the tilted up position when trailing the boat. Use of the tilt lock mechanism could allow the outboard to bounce, and drop down causing damage to the outboard.

The boat should be trailed with the outboard tilted down (normal operating position).

If additional ground clearance is required, remove the outboard from the boat, and store securely. Additional clearance may be needed for railroad crossings, driveways, and trailer bouncing.

Set the gear shift into forward gear. This prevents the propeller from spinning freely.

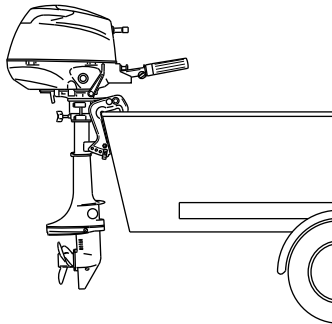

19049

# FUEL AND OIL

## Fuel Recommendations

**IMPORTANT:** Use of improper gasoline can damage your engine. Engine damage resulting from the use of improper gasoline is considered misuse of the engine, and damage caused thereby will not be covered under the limited warranty.

### FUEL RATINGS

Mercury Marine engines will operate satisfactorily when using a major brand of unleaded gasoline meeting the following specifications:

**USA and Canada** - having a posted pump Octane Rating of 87 (R+M)/2 minimum. Premium gasoline (92 [R+M]/2 Octane) is also acceptable. Do not use leaded gasoline.

**Outside USA and Canada** - having a posted pump Octane Rating of 90 RON minimum. Premium gasoline (98 RON) is also acceptable. If unleaded gasoline is not available, use a major brand of leaded gasoline.

### USING REFORMULATED (OXYGENATED) GASOLINES (USA ONLY)

This type of gasoline is required in certain areas of the USA. The 2 types of oxygenates used in these fuels are alcohol (ethanol) or ether (MTBE or ETBE). If ethanol is the oxygenate that is used in the gasoline in your area, refer to **Gasolines Containing Alcohol**.

These reformulated gasolines are acceptable for use in your Mercury Marine engine.

### GASOLINES CONTAINING ALCOHOL

If the gasoline in your area contains either methanol (methyl alcohol) or ethanol (ethyl alcohol), you should be aware of certain adverse effects that can occur. These adverse effects are more severe with methanol. Increasing the percentage of alcohol in the fuel can also worsen these adverse effects.

Some of these adverse effects are caused because the alcohol in the gasoline can absorb moisture from the air, resulting in a separation of the water/alcohol from the gasoline in the fuel tank.

# FUEL AND OIL

The fuel system components on your Mercury Marine engine will withstand up to 10% alcohol content in the gasoline. We do not know what percentage your boat's fuel system will withstand. Contact your boat manufacturer for specific recommendations on the boat's fuel system components (fuel tanks, fuel lines, and fittings). Be aware that gasolines containing alcohol may cause increased:

- Corrosion of metal parts
- Deterioration of rubber or plastic parts
- Fuel permeation through rubber fuel lines
- Starting and operating difficulties

## WARNING

**Fuel leakage is a fire or explosion hazard, which can cause serious injury or death. Periodically inspect all fuel system components for leaks, softening, hardening, swelling, or corrosion, particularly after storage. Any sign of leakage or deterioration requires replacement before further engine operation.**

Because of possible adverse effects of alcohol in gasoline, it is recommended that only alcohol-free gasoline be used where possible. If only fuel containing alcohol is available, or if the presence of alcohol is unknown, increased inspection frequency for leaks and abnormalities is required.

**IMPORTANT:** When operating a Mercury Marine engine on gasoline containing alcohol, storage of gasoline in the fuel tank for long periods should be avoided. Long periods of storage, common to boats, create unique problems. In cars, alcohol-blend fuels normally are consumed before they can absorb enough moisture to cause trouble, but boats often sit idle long enough for phase separation to take place. In addition, internal corrosion may take place during storage if alcohol has washed protective oil films from internal components.

# FUEL AND OIL

## Special Features of the Fuel Tank

The Environmental Protection Agency (EPA) will require the fuel tank on outboards produced after January 1, 2011 to remain fully sealed (pressurized) up to 24.1 kPa (3.5 psi).

The fuel cap has a two-way valve which allows air to enter the tank as the fuel is drawn to the engine, and also opens to vent to the atmosphere if internal pressure in the tank exceeds 24.1 kPa (3.5 psi). A hissing noise may be heard as the tank vents to the atmosphere. This is normal.

## REMOVING THE FUEL CAP

**IMPORTANT: Contents may be under pressure. Rotate the fuel cap 1/4 turn to relieve pressure before opening.**

1. Open the manual vent screw on top of the fuel cap.
2. Rotate the fuel cap 1/4 turn to relieve pressure and slowly open the cap.

## INSTALLING THE FUEL CAP

1. When installing the fuel cap, turn the cap to the right until you hear a click. This signals that the fuel cap is fully seated. A built-in device prevents overtightening.
2. Open the manual vent screw on top of the cap for operation and cap removal. Close the manual vent screw for transportation.

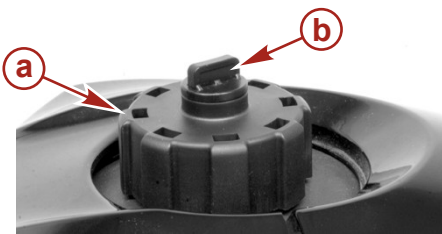

47368

- a** - Fuel cap  
**b** - Manual vent screw

# FUEL AND OIL

## Filling the Fuel Tank

### WARNING

**Avoid serious injury or death from a gasoline fire or explosion. Use caution when filling fuel tanks. Always stop the engine and do not smoke or allow open flames or sparks in the area while filling fuel tanks.**

Fill the fuel tank outdoors away from heat, sparks, and open flames.

Remove portable fuel tanks from the boat to refill them.

Always stop the engine before refilling the fuel tank.

Do not completely fill the fuel tank. Leave approximately 10% of the tank volume unfilled. Fuel will expand in volume as its temperature rises, and can leak under pressure if the fuel tank is completely filled.

## Engine Oil Recommendations

We recommend the use of Mercury or Quicksilver NMMA FC-W certified 10W-30 4-Stroke Outboard Oil for general, all-temperature use. If NMMA certified synthetic blend 25W-40 4-Stroke outboard oil is preferred, use Mercury or Quicksilver synthetic blend 4-Stroke Outboard Oil. If the recommended Mercury or Quicksilver NMMA FC-W certified outboard oils are not available, a major FC-W certified 4-stroke outboard oil may be used.

# FUEL AND OIL

**IMPORTANT:** The use of detergent oils, multi-viscosity oils (other than Mercury or Quicksilver NMMA FC-W certified oil or a major brand NMMA FC-W certified oil), synthetic oils, low quality or oils that contain solid additives are not recommended.

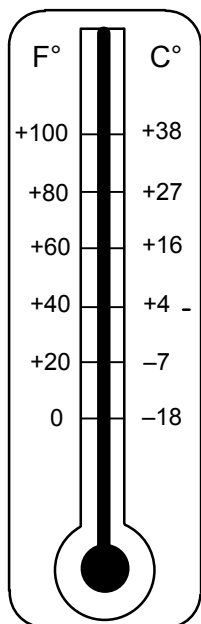

26795

## Recommended SAE viscosity for engine oil

- a** - NMMA FC-W certified 25W-40 4-stroke outboard oil may be used at temperatures above 4 °C (40 °F)
- b** - NMMA FC-W certified 10W-30 4-stroke outboard oil is recommended for use in all temperatures.

## Checking Engine Oil

**IMPORTANT:** Do not overfill. Be sure that the outboard is upright (not tilted) when checking oil.

1. Position the outboard so it is sitting level.
2. Verify the oil level through the oil level inspection window. If the oil level is down toward the lower level mark, remove the oil fill cap, and fill up to the upper level mark.

**NOTE:** If oil level is at the lower mark, add 100 ml (3 oz.) of oil.



# FUEL AND OIL

3. Reinstall the oil fill cap, and tighten securely.

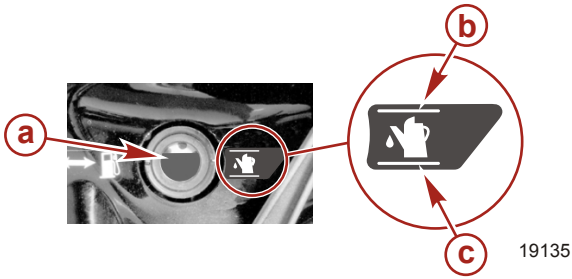

- a** - Oil level inspection window
- b** - Upper oil level
- c** - Lower oil level

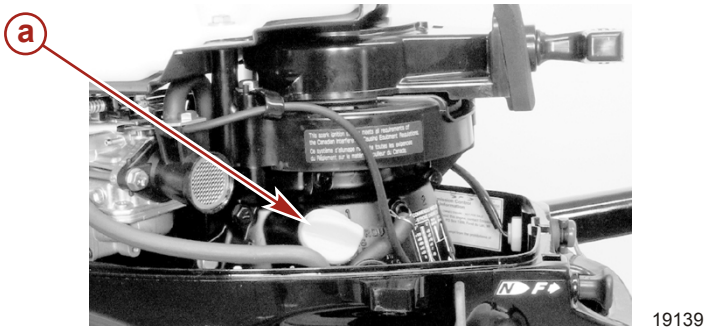

- a** - Oil fill cap

# FEATURES AND CONTROLS

## Features and Controls

Fuel shut off valve - Turn the valve to the close position to shut off the fuel flow to the engine. Turn the valve to the open position when starting the engine.

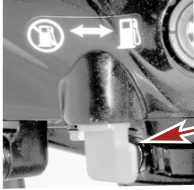

**c**

18843

- a** - Closed position
- b** - Open position
- c** - Fuel shut off valve



Choke knob - Pull completely out when starting a cold engine. Push halfway in as the engine is warming up. Push in completely after the engine is warmed up.

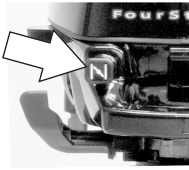

19088

Throttle grip friction knob - Use the friction knob to set the throttle grip at a desired speed. Turn the knob clockwise to tighten friction or turn counterclockwise to loosen friction.

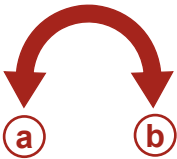

19096

- a** - Direction to loosen friction
- b** - Direction to tighten friction

# FEATURES AND CONTROLS

## ⚠ WARNING

Insufficient friction adjustment can cause serious injury or death due to loss of boat control. When setting the friction adjustment, maintain sufficient steering friction to prevent the outboard from steering into a full turn if the tiller handle or steering wheel is released.

Steering friction adjustment - Adjust this knob to achieve the desired steering friction (drag) on the tiller handle. Turn the knob clockwise to tighten friction and counterclockwise to loosen friction.

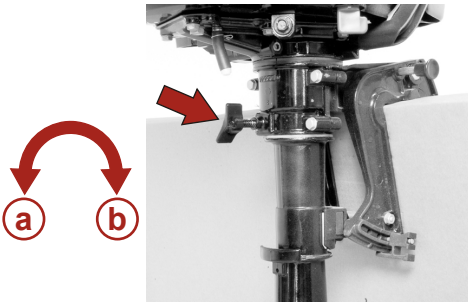

19100

- a** - Direction to loosen friction
- b** - Direction to tighten friction

Side handle gear shift - Controls gear shift. Place the gear shift into neutral position when starting the engine. F = forward gear, N = neutral position.

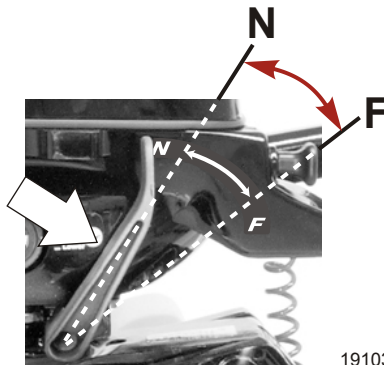

19103

# FEATURES AND CONTROLS

Engine stop switch/lanyard stop switch - Push in or pull lanyard to stop the engine. The engine will not start unless the lanyard is engaged with the stop switch.

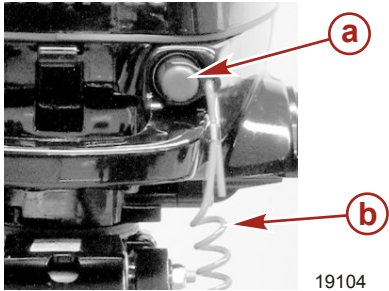

- a** - Engine stop switch/lanyard stop switch
- b** - Lanyard

Starter rope - Pulling the starter rope cranks the engine over for starting.

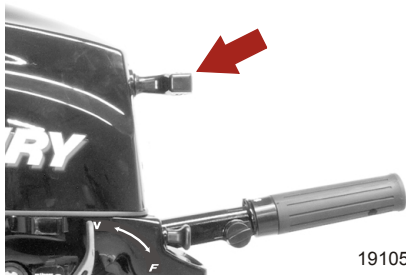

## Tilting Outboard

### TILTING TO FULL UP POSITION

1. Stop the engine.
2. Take hold of the top cowl grip, and raise outboard to the full up position.

# FEATURES AND CONTROLS

3. Push in the tilt support pin. Lower the outboard to rest on the tilt support pin.

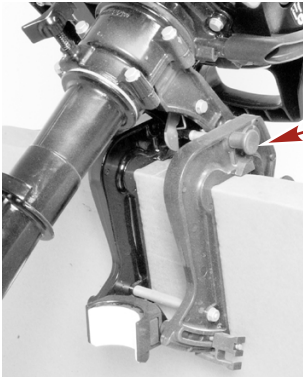

**a** - Tilt support pin

19051

## LOWERING TO RUN POSITION

Lift the outboard and pull out the tilt support pin. Lower the outboard.

## Setting the Operating Angle of the Outboard

The vertical operating angle of the outboard is adjusted by changing the position of the tilt pin in the adjustment holes provided. Proper adjustment allows the boat to achieve optimum performance, stability, and minimize steering effort.

The tilt pin should be adjusted so the outboard is positioned to run perpendicular to the water when the boat is running at full speed. This allows the boat to be driven parallel to the water.

Arrange passengers and load in the boat so the weight is distributed evenly.

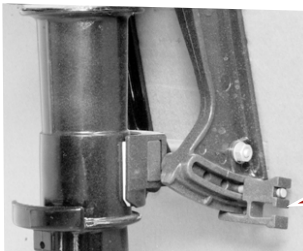

**a** - Tilt pin

19052

# OPERATION

## Prestarting Check List

- Operator knows safe navigation, boating, and operating procedures.
- An approved personal flotation device of suitable size for each person aboard and readily accessible (it is the law).
- A ring type life buoy or buoyant cushion designed to be thrown to a person in the water.
- Know your boats' maximum load capacity. Look at the boat capacity plate.
- Fuel supply OK.
- Arrange passengers and load in the boat so the weight is distributed evenly and everyone is seated in a proper seat.
- Tell someone where you are going and when you expect to return.
- It is illegal to operate a boat while under the influence of alcohol or drugs.
- Know the waters and area you will be boating; tides, currents, sand bars, rocks, and other hazards.
- Make inspection checks listed in **Maintenance - Inspection and Maintenance Schedule**.

## Operating in Freezing Temperatures

When using your outboard or having your outboard moored in freezing or near freezing temperatures, keep the outboard tilted down at all times so the gearcase is submerged. This prevents the trapped water in the gearcase from freezing and causing possible damage to the water pump and other components.

If there is a chance of ice forming on the water, the outboard should be removed and drained completely of water. If ice should form at the water level inside the outboard driveshaft housing, it will block water flow to the engine causing possible damage.

# OPERATION

## Operating in Saltwater or Polluted Water

We recommend that you flush the internal water passages of your outboard with fresh water after each use in salt or polluted water. This will prevent a buildup of deposits from clogging the water passages. Refer to **Maintenance - Flushing the Cooling System**.

If you keep your boat moored in the water, always tilt the outboard so the gearcase is completely out of water (except in freezing temperatures) when not in use.

Wash the outboard exterior and flush out the exhaust outlet of the propeller and gearcase with fresh water after each use. Each month, spray Mercury Precision or Quicksilver Corrosion Guard on external metal surfaces. Do not spray on corrosion control anodes as this will reduce the effectiveness of the anodes.

## Engine Break-in Procedure

**IMPORTANT: Failure to follow the engine break-in procedures can result in poor performance throughout the life of the engine and can cause engine damage. Always follow break-in procedures.**

1. For the first hour of operation, run the engine at varied throttle settings up to 2000 RPM or at approximately half throttle.
2. For the second hour of operation, run the engine at varied throttle settings up to 3000 RPM or at three-quarter throttle, and at full throttle for approximately one minute every ten minutes.
3. For the next eight hours of operation, avoid continuous operation at full throttle for more than five minutes at a time.

## Starting the Engine

Before starting, read the **Prestarting Check List** and **Engine Break-in Procedure** in the **Operation** section.

# OPERATION

## NOTICE

Without sufficient cooling water, the engine, the water pump, and other components will overheat and suffer damage. Provide a sufficient supply of water to the water inlets during operation.

1. Check the engine oil level. Place the outboard in a level position and check that the engine oil level is within the operating range.

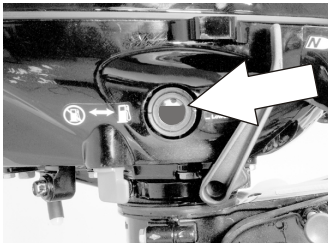

19160

2. Shift the outboard to the neutral (N) position.

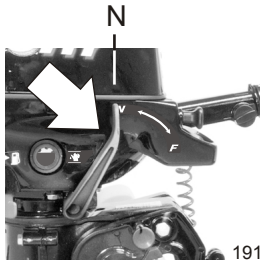

19170

3. Make sure the cooling water intake is submerged.

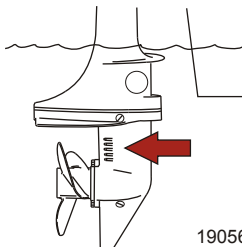

19056



# OPERATION

4. Open the manual vent screw on the fuel tank.

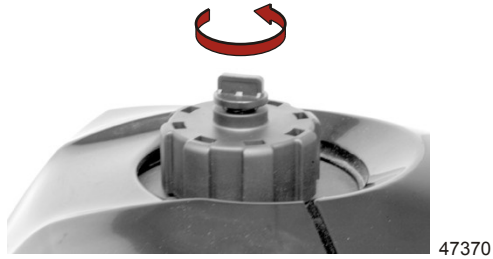

5. Move the fuel shut off valve to the open position.

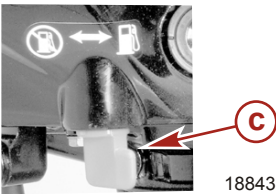

- a - Closed position
- b - Open position
- c - Fuel shut off valve



6. Attach the lanyard to the stop switch. Refer to **General Information - Lanyard Stop Switch**.

**NOTE:** The engine will not start unless the lanyard is engaged with the stop switch.

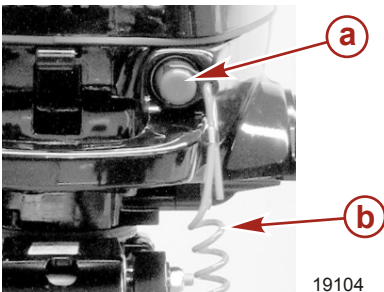

- a - Stop switch
- b - Lanyard

# OPERATION

7. If the engine is cold, set the throttle grip to the "START" position. If the engine is warm, set the throttle grip to the "RE-START" position.

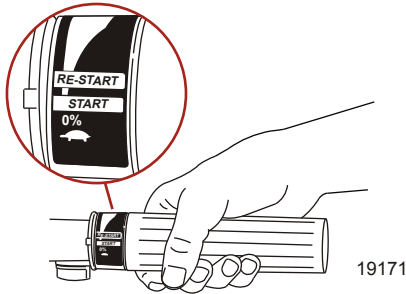

8. If the engine is cold, completely pull out the choke. Push in the choke halfway as the engine is warming up. Push in completely after the engine is warmed up.

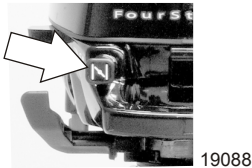

**NOTE:** Starting flooded engine - Push in the choke knob. Wait 30 seconds, then continue to crank the engine for starting.

9. Pull the starter rope slowly until you feel the starter engage, then pull rapidly to crank the engine. Allow the rope to return slowly. Repeat until the engine starts.



10. Check for a steady stream of water flowing out of the water pump indicator hole.

# OPERATION

**IMPORTANT:** If no water is coming out of the water pump indicator hole, stop the engine and check cooling water intake for obstruction. No obstruction may indicate a water pump failure, or blockage in the cooling system. These conditions will cause the engine to overheat. Have the outboard checked by a dealer. Operating the engine while overheated may cause serious engine damage.

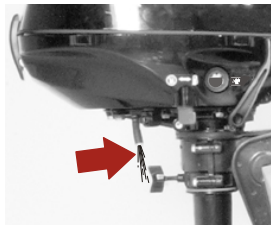

19246

## Gear Shifting

The outboard has two gear shift positions to provide operation: Forward (F), and Neutral (N).

Reduce throttle speed to idle speed.

Always shift the outboard into gear with a quick motion.

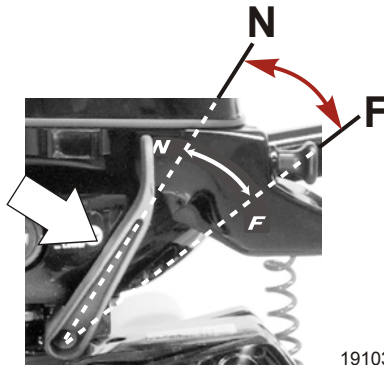

19103

## Reversing Boat

1. Move the throttle grip to the slow position.
2. To reverse direction, turn the outboard 180°. The tiller handle can be swung back for ease of operation.

# OPERATION

- Return the throttle grip to the slow position when turning the outboard back to forward direction.

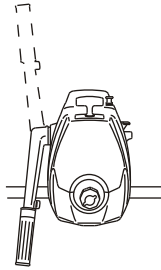

20272

## Stopping the Engine

Reduce engine speed and push in the stop switch or pull the lanyard.

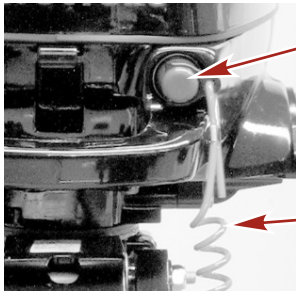

19104

- a** - Stop switch
- b** - Lanyard

# MAINTENANCE

## Outboard Care

To keep your outboard in the best operating condition, it is important that your outboard receive the periodic inspections and maintenance listed in the **Inspection and Maintenance Schedule**. We urge you to keep it maintained properly to ensure the safety of you and your passengers, and retain its dependability.

Record maintenance performed in the **Maintenance Log** at the back of this book. Save all maintenance work orders and receipts.

## SELECTING REPLACEMENT PARTS FOR YOUR OUTBOARD

We recommend using original Mercury Precision or Quicksilver replacement parts and Genuine Lubricants.

## EPA Emission Regulations

All new outboards manufactured by Mercury Marine are certified to the United States Environmental Protection Agency, as conforming to the requirements of the regulations for the control of air pollution from new outboard motors. This certification is contingent on certain adjustments set to factory standards. For this reason, the factory procedure for servicing the product must be strictly followed and, wherever practicable, returned to the original intent of the design. **Maintenance, replacement, or repair of the emission control devices and systems may be performed by any marine spark ignition (SI) engine repair establishment or individual.**

# MAINTENANCE

## EMISSION CERTIFICATION LABEL

An emission certification label, showing emission levels and engine specifications directly related to emissions, is placed on the engine at time of manufacture.

The image shows a rectangular label titled "EMISSION CONTROL INFORMATION". At the top, it states: "THIS ENGINE CONFORMS TO  CALIFORNIA AND U.S. EPA EMISSION REGULATIONS FOR SPARK IGNITION MARINE ENGINES. REFER TO OWNER'S MANUAL FOR REQUIRED MAINTENANCE SPECIFICATIONS AND ADJUSTMENTS. PLEASE PERFORM THE ENGINE MAINTENANCE CORRECTLY." Below this, there are several fields for engine specifications: "DISPLACEMENT:  FAMILY: ", "FEL: HC+NOx=  CO=  HP: ", "LOW-PERM/HIGH-PERM:  MAXIMUM POWER: ", and "TIMING:  IDLE SPEED (IN GEAR): ". At the bottom, the brand name "MERCURY MARINE" is printed. The label is flanked by a calendar grid with months from JAN to DEC. Red callout letters a through h point to specific fields: 'a' points to the displacement field, 'b' to the FEL field, 'c' to the Low-Perm/High-Perm field, 'd' to the timing field, 'e' to the family number field, 'f' to the family description field, 'g' to the maximum power field, and 'h' to the idle speed field.

43058

- a** - Piston displacement
- b** - Maximum emission output for the engine family
- c** - Percent of fuel line permeation
- d** - Timing specification
- e** - Family number
- f** - Engine family description
- g** - Engine power - kilowatts
- h** - Idle speed

## OWNER RESPONSIBILITY

The owner/operator is required to have routine engine maintenance performed to maintain emission levels within prescribed certification standards.

The owner/operator is not to modify the engine in any manner that would alter the horsepower or allow emission levels to exceed their predetermined factory specifications.

## Inspection and Maintenance Schedule

### BEFORE EACH USE

- Check the engine oil level. See **Fuel and Oil - Checking and Adding Engine Oil**.
- Visually inspect the fuel system for deterioration or leaks.

# MAINTENANCE

- Check outboard for tightness on transom.
- Check propeller blades for damage.

## AFTER EACH USE

- Flush out the outboard cooling system if operating in salt or polluted water. See **Flushing the Cooling System**.

## EVERY 100 HOURS OF USE OR ONCE YEARLY, WHICHEVER OCCURS FIRST

- Lubricate all lubrication points. Lubricate more frequently when used in saltwater. See **Lubrication Points**.
- Change engine oil. The oil should be changed more often when the engine is operated under adverse conditions such as extended trolling. See **Changing Engine Oil**.
- Replace spark plug at first 100 hours or first year. After that, inspect the spark plug every 100 hours or once yearly. Replace the spark plug as needed. See **Spark Plug Inspection and Replacement**.
- Drain and replace gearcase lubricant. See **Gearcase Lubrication**.
- Check corrosion control anode. Check more frequently when used in saltwater. See **Corrosion Control Anode**.
- Check and adjust valve clearance, if necessary.<sup>1</sup>
- Lubricate splines on the driveshaft.<sup>1</sup>
- Replace water pump impeller.<sup>1</sup>
- Check tightness of bolts, nuts, and other fasteners.
- Check cowl seals to make sure seals are intact and not damaged.
- Check internal cowl sound reduction foam (if equipped) to make sure foam is intact and not damaged.
- Check that the intake silencer (if equipped) is in place.
- Check that the idle relief muffler (if equipped) is in place.
- Check for loose hose clamps and rubber boots (if equipped) on the air intake assembly.

1. These items should be serviced by an authorized dealer.

# MAINTENANCE

## BEFORE PERIODS OF STORAGE

- Refer to Storage procedure. See **Storage** section.

## Flushing the Cooling System

Flush the internal water passages of the outboard with fresh water after each use in salt, polluted, or muddy water. This will help prevent a buildup of deposits from clogging the internal water passages.

Use a Mercury Precision or Quicksilver accessory (or equivalent) flushing attachment.

**NOTE:** Do not run the engine while flushing the cooling system.

1. Remove the plug and gasket.
2. Attach the hose coupling to the engine.
3. Attach a water hose to the hose coupling. Turn on the water gently and flush the cooling system for 3 to 5 minutes.
4. Turn the water off. Remove the hose coupling and reinstall the plug and gasket.

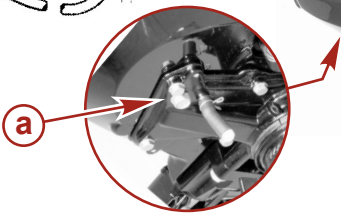
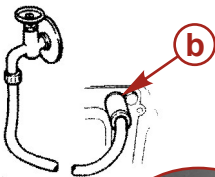

19132

**a** - Plug and gasket

**b** - Hose coupling



# MAINTENANCE

## Top Cowl Removal and Installation

### REMOVAL

1. Release the rear cowl latch.



2. Lift up the rear of the cowl and push it towards the front of the engine to clear the front hook.

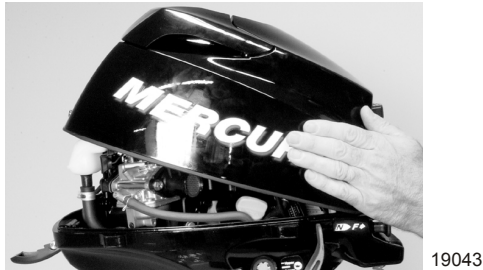

### INSTALLATION

1. Engage the front hook and position the cowl over the engine.
2. Lock the rear cowl latch.

### Corrosion Control Anode

Your outboard has a corrosion control anode installed on the gearcase. An anode helps protect the outboard against galvanic corrosion by sacrificing its metal to be slowly corroded instead of the outboard metals.

# MAINTENANCE

The anode requires periodic inspection especially in saltwater which will accelerate the erosion. To maintain this corrosion protection, always replace the anode before it is completely eroded. Never paint or apply a protective coating on the anode as this will reduce effectiveness of the anode.

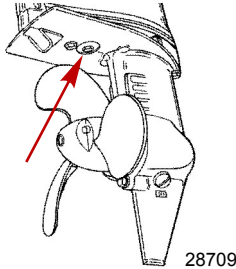

## Exterior Care

Your outboard is protected with a durable baked enamel finish. Clean and wax often using marine cleaners and waxes.

## Propeller Replacement

### WARNING

Rotating propellers can cause serious injury or death. Never operate the boat out of the water with a propeller installed. Before installing or removing a propeller, place the drive unit in neutral and engage the lanyard stop switch to prevent the engine from starting. Place a block of wood between the propeller blade and the anti-ventilation plate.

1. Remove the spark plug lead to prevent the engine from starting.

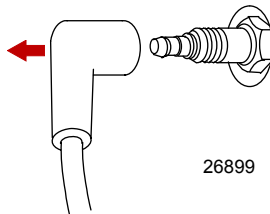

# MAINTENANCE

2. Move the gear shift lever into neutral.

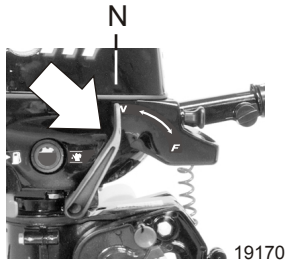

3. Straighten and remove the cotter pin.

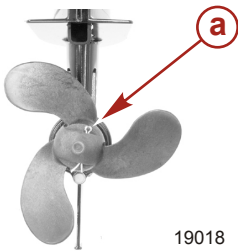

**a** - Cotter pin

4. Pull the propeller straight off the shaft. Retain the drive pin.  
If the propeller is seized to the shaft and cannot be removed, have the propeller removed by an authorized dealer.

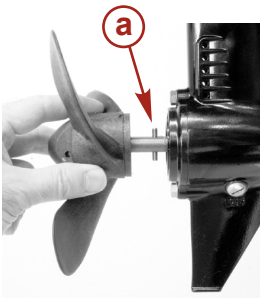

**a** - Drive pin

# MAINTENANCE

5. Insert the drive pin into the propeller shaft.

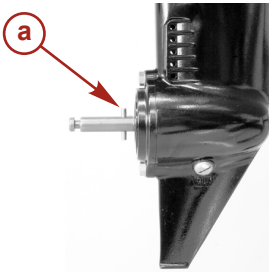

19023

**a** - Drive pin

6. Slide the propeller onto the shaft, making sure the slot in the propeller engages with the drive pin.
7. Install the cotter pin through the hole in the propeller and bend the cotter pin ends.

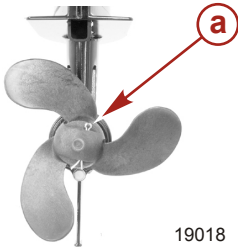

19018

**a** - Cotter pin

## Spark Plug Inspection and Replacement

### WARNING

Damaged spark plug boots may emit sparks which can ignite fuel vapors under the engine cowl, resulting in serious injury or death from a fire or explosion. To avoid damaging the spark plug boots, do not use any sharp object or metal tool to remove the spark plug boots.

# MAINTENANCE

1. Remove the spark plug boot. Twist the rubber boot slightly and pull off.

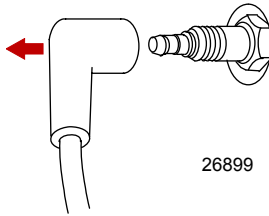

2. Remove the spark plug to inspect. Replace spark plug if electrode is worn or the insulator is rough, cracked, broken, blistered, or fouled.

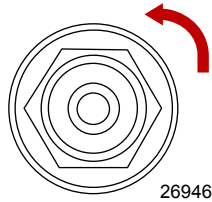

3. Set the spark plug gap to specification.

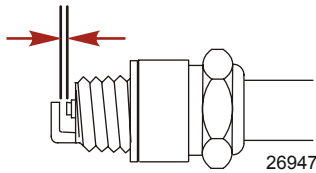

Spark Plug	
Spark plug gap	0.9 mm (0.035 in.)



4. Before installing spark plug, clean off any dirt on the spark plug seat. Install plug finger-tight, and then tighten 1/4 turn or torque to specifications.

Description	Nm	lb-in.	lb-ft
Spark plug	27		20

## Lubrication Points

Lubricate the following with Quicksilver or Mercury Precision Lubricants 2-4-C with PTFE or Special Lubricant 101.

# MAINTENANCE

Tube Ref No.	Description	Where Used	Part No.
 95	2-4-C with PTFE	Steering friction knob threads, swivel bracket bushing, tilt support pin, transom clamp screws	92-802859A 1
 34	Special Lubricant 101	Steering friction knob threads, swivel bracket bushing, tilt support pin, transom clamp screws	92-802865Q02

- Steering friction knob - lubricate threads.

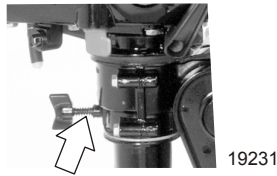

- Tilt support pin - lubricate pin
- Transom clamp screws - lubricate threads
- Tilt pivot point - lubricate with lightweight oil

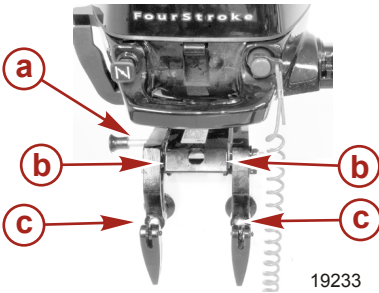

- a** - Tilt support pin
- b** - Tilt pivot point
- c** - Transom clamp screws

# MAINTENANCE

- Tiller handle rubber bushing - lubricate internal diameter with lightweight oil.

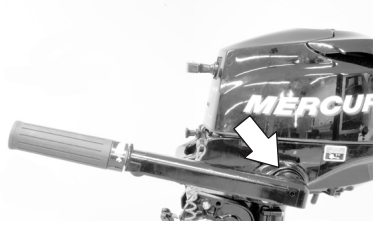

19234

- Swivel bracket - remove four bolts and rear cover and lubricate the inner nylon bushing.

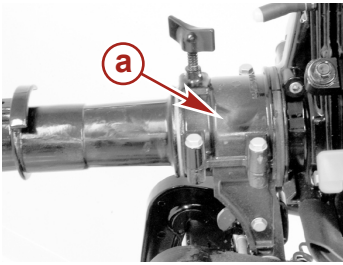

**a** - Rear cover

19240

## Changing Engine Oil

### ENGINE OIL CAPACITY

Engine oil capacity is approximately 300 ml (10 fl. oz.).

### OIL CHANGING PROCEDURE

1. Place outboard in an upright (not tilted) position.
2. Turn the outboard to gain access to the drain plug. Remove drain plug and drain engine oil into an appropriate container. Lubricate the seal on the drain plug with oil and reinstall.

# MAINTENANCE

**IMPORTANT:** Inspect oil for signs of contamination. Oil contaminated with water will have a milky color to it; oil contaminated with fuel will have a strong fuel smell. If contaminated oil is noticed, have the engine checked by your dealer.

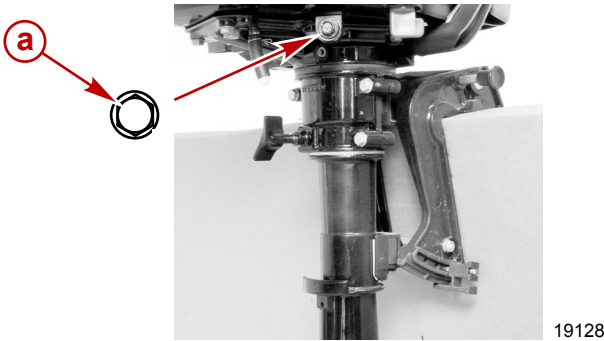

**a** - Drain plug

## OIL FILLING

**IMPORTANT:** Do not overfill. Be sure that the outboard is upright (not tilted) when checking oil.

Remove the oil fill cap and refill with 300 ml (10 fl. oz.) of oil. Reinstall the oil fill cap.

Idle engine for five minutes and check for leaks. Stop engine and check oil level. Add oil if necessary.

## Gearcase Lubrication

When adding or changing gearcase lubricant, visually check for the presence of water in the lubricant. If water is present, it may have settled to the bottom and will drain out prior to the lubricant, or it may be mixed with the lubricant, giving it a milky colored appearance. If water is noticed, have the gearcase checked by your dealer. Water in the lubricant may result in premature bearing failure or, in freezing temperatures, will turn to ice and damage the gearcase.



# MAINTENANCE

Examine the drained gearcase lubricant for metal particles. A small amount of metal particles indicates normal gear wear. An excessive amount of metal filings or larger particles (chips) may indicate abnormal gear wear and should be checked by an authorized dealer.

## DRAINING GEARCASE

1. Place the outboard in a vertical operating position.
2. Place drain pan below outboard.
3. Remove vent plug and fill/drain plug and drain lubricant.

**NOTE:** Replace the sealing washers with new washers.

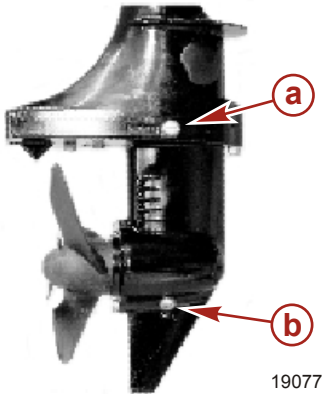

- a** - Vent plug
- b** - Fill/drain plug

19077

## GEARCASE LUBRICANT CAPACITY

Gearcase lubricant capacity is approximately 180 ml (6.0 fl oz).

## CHECKING LUBRICANT LEVEL AND REFILLING GEARCASE

1. Place the outboard in a vertical operating position.
2. Remove vent plug.

# MAINTENANCE

- Remove fill/drain plug. Place lubricant tube into the fill hole and add lubricant until it appears at the vent hole.

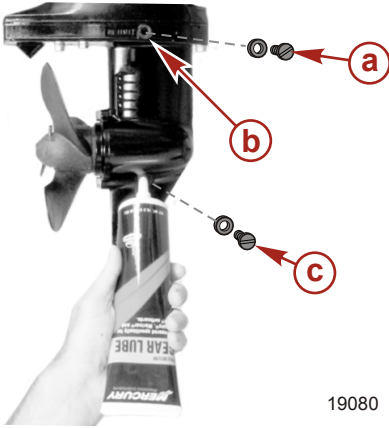

- a** - Vent plug and new sealing washer
- b** - Vent hole
- c** - Fill/drain plug and new sealing washer

19080

Tube Ref No.	Description	Where Used	Part No.
 82	Premium Gear Lubricant	Gearcase	92-858058K01

- Stop adding lubricant. Use new sealing washer and install the vent plug before removing the lubricant tube.
- Remove lubricant tube and reinstall cleaned fill/drain plug and new sealing washer.

## Submerged Outboard

A submerged outboard will require service within a few hours by an authorized dealer once the outboard is recovered from the water. This immediate attention by a servicing dealer is necessary once the engine is exposed to the atmosphere to minimize internal corrosion damage to the engine.

# STORAGE

## Storage Preparation

The major consideration in preparing your outboard for storage is to protect it from rust, corrosion, and damage caused by freezing of trapped water.

The following storage procedures should be followed to prepare your outboard for out of season storage or prolonged storage (two months or longer).

### *NOTICE*

Without sufficient cooling water, the engine, the water pump, and other components will overheat and suffer damage. Provide a sufficient supply of water to the water inlets during operation.

## FUEL SYSTEM

**IMPORTANT:** Gasoline containing alcohol (ethanol or methanol) can cause a formation of acid during storage and can damage the fuel system. If the gasoline being used contains alcohol, it is advisable to drain as much of the remaining gasoline as possible from the fuel tank, remote fuel line, and engine fuel system.

Fill the fuel tank and engine fuel system with treated (stabilized) fuel to help prevent formation of varnish and gum. Proceed with following instructions.

- Pour the required amount of gasoline stabilizer (follow instructions on container) into fuel tank. Tip fuel tank back and forth to mix stabilizer with the fuel.
- Place the outboard in water. Run the engine for five minutes to allow treated fuel to reach the carburetor.

## Protecting External Outboard Components

- Lubricate all outboard components listed in **Maintenance - Inspection and Maintenance Schedule**.
- Touch up any paint nicks. See your dealer for touch-up paint.
- Spray Quicksilver or Mercury Precision Lubricants Corrosion Guard on external metal surfaces (except corrosion control anodes).

# STORAGE

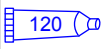
Tube Ref No.	Description	Where Used	Part No.
 120	Corrosion Guard	External metal surfaces	92-802878 55

## Protecting Internal Engine Components

- Remove the spark plug and inject a small amount of engine oil inside the cylinder.
- Rotate the flywheel manually several times to distribute the oil in the cylinder. Reinstall spark plug.
- Change the engine oil.

## Gearcase

- Drain and refill the gearcase lubricant (refer to **Gearcase Lubrication**).

## Positioning Outboard for Storage

### NOTICE

Storing the outboard in a tilted position can damage the outboard. Water trapped in the cooling passages or rain water collected in the propeller exhaust outlet in the gearcase can freeze. Store the outboard in the full down position.

1. Carry, transport, or store the outboard only in the following two positions. These positions will prevent oil from draining out of the crankcase.

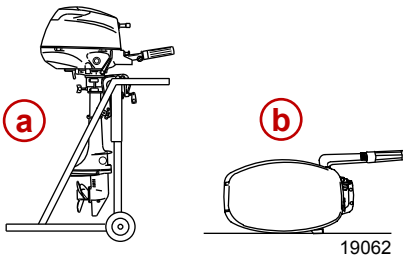

- a - Upright position
- b - Tiller handle up position

# STORAGE

2. Never carry, store, or transport the outboard in the positions shown below. Engine damage could result from oil draining out of the crankcase.

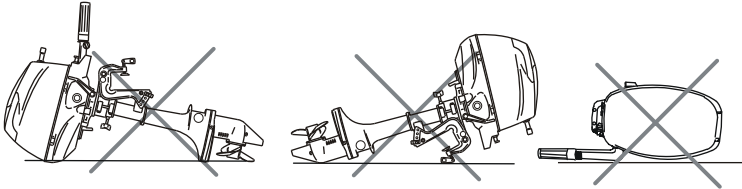

19063

# OWNER SERVICE ASSISTANCE

## Local Repair Service

Always return your outboard to your local authorized dealer should the need for service arise. Only he has the factory trained mechanics, knowledge, special tools, equipment, and genuine parts and accessories to properly service your engine should the need occur. He knows your engine best.

## Service Away from Home

If you are away from your local dealer and the need arises for service, contact the nearest authorized dealer. Refer to the Yellow Pages of the telephone directory. If, for any reason, you cannot obtain service, contact the nearest Mercury Marine Service Office.

## Parts and Accessories Inquiries

All inquiries concerning genuine replacement parts and accessories should be directed to your local authorized dealer. The dealer has the necessary information to order parts and accessories for you. When inquiring on parts and accessories, the dealer requires the model and serial number to order the correct parts.

## Service Assistance

Your satisfaction with your outboard product is very important to your dealer and to us. If you ever have a problem, question or concern about your outboard product, contact your dealer or any authorized Mercury Marine dealership. If additional assistance is required, take these steps.

1. Talk with the dealership's sales manager or service manager. If this has already been done, then contact the owner of the dealership.
2. Should you have a question, concern, or problem that cannot be resolved by your dealership, please contact Mercury Marine Service Office for assistance. Mercury Marine will work with you and your dealership to resolve all problems.

The following information will be needed by the service office:

# OWNER SERVICE ASSISTANCE

- Your name and address
- Daytime telephone number
- Model and serial number of your outboard
- The name and address of your dealership
- Nature of problem

## Mercury Marine Service Offices

For assistance, call, fax, or write. Please include your daytime telephone number with mail and fax correspondence.

<b>United States, Canada</b>		
Telephone	English - (920) 929-5040 Français - (905) 636-4751	Mercury Marine W6250 W. Pioneer Road P.O. Box 1939 Fond du Lac, WI 54936-1939
Fax	English - (920) 929-5893 Français - (905) 636-1704	
Website	www.mercurymarine.com	

<b>Australia, Pacific</b>		
Telephone	(61) (3) 9791-5822	Brunswick Asia Pacific Group 41-71 Bessemer Drive Dandenong South, Victoria 3175 Australia
Fax	(61) (3) 9706-7228	

<b>Europe, Middle East, Africa</b>		
Telephone	(32) (87) 32 • 32 • 11	Brunswick Marine Europe Parc Industriel de Petit-Rechain B-4800 Verviers, Belgium
Fax	(32) (87) 31 • 19 • 65	

<b>Mexico, Central America, South America, Caribbean</b>		
Telephone	(954) 744-3500	Mercury Marine 11650 Interchange Circle North Miramar, FL 33025 U.S.A.
Fax	(954) 744-3535	

<b>Japan</b>		
Telephone	072-233-8888	Kisaka Co., Ltd. 4-130 Kannabecho Sakai-shi Sakai-ku 5900984 Osaka, Japan
Fax	072-233-8833	

# OWNER SERVICE ASSISTANCE

Asia, Singapore		
Telephone	(65) 65466160	Brunswick Asia Pacific Group T/A Mercury Marine Singapore Pte Ltd 29 Loyang Drive Singapore, 508944
Fax	(65) 65467789	



# MAINTENANCE LOG

## Maintenance Log

Record all maintenance performed on your outboard here. Be sure to save all work orders and receipts.

Date	Maintenance Performed	Engine Hours