

## Thank You

for your purchase of one of the finest outboards available. You have made a sound investment in boating pleasure. Your outboard has been manufactured by Mercury Marine, a world leader in marine technology and outboard manufacturing since 1939. These years of experience have been committed to the goal of producing the finest quality products. This led to Mercury Marine's reputation for strict quality control, excellence, durability, lasting performance, and being the best at providing after the sale support.

Please read this manual carefully before operating your outboard. This manual has been prepared to assist you in the operation, safe use, and care of your outboard.

All of us at Mercury Marine took pride in building your outboard and wish you many years of happy and safe boating.

Again, thank you for your confidence in Mercury Marine.

## EPA Emissions Regulations

Outboards sold by Mercury Marine in the United States are certified to the United States Environmental Protection Agency as conforming to the requirements of the regulations for the control of air pollution from new outboard motors. This certification is contingent on certain adjustments being set to factory standards. For this reason, the factory procedure for servicing the product must be strictly followed and, wherever practicable, returned to the original intent of the design.

**Maintenance, replacement, or repair of the emission control devices and systems may be performed by any marine engine repair establishment or individual.**

Engines are labeled with an Emission Control Information decal as permanent evidence of EPA certification.

### WARNING

**The engine exhaust from this product contains chemicals known to the state of California to cause cancer, birth defects or other reproductive harm.**

## Warranty Message

The product you have purchased comes with a **limited warranty** from Mercury Marine, the terms of the warranty are set forth in the **Warranty Information** section of this manual. The warranty statement contains a description of what is covered, what is not covered, the duration of coverage, how to best obtain warranty coverage, **important disclaimers and limitations of damages**, and other related information. Please review this important information.

The description and specifications contained herein were in effect at the time this manual was approved for printing. Mercury Marine, whose policy is one of continued improvement, reserves the right to discontinue models at any time, to change specifications, designs, methods, or procedures without notice and without incurring obligation.

Mercury Marine, Fond du Lac, Wisconsin U.S.A.

Litho in U.S.A.

© 2011, Mercury Marine

Mercury, Mercury Marine, MerCruiser, Mercury MerCruiser, Mercury Racing, Mercury Precision Parts, Mercury Propellers, Mariner, Quicksilver, #1 On The Water, Alpha, Bravo, Pro Max, OptiMax, Sport-Jet, K-Planes, MerCathode, RideGuide, SmartCraft, Zero Effort, M with Waves logo, Mercury with Waves logo, and SmartCraft logo are all registered trademarks of Brunswick Corporation. Mercury Product Protection logo is a registered service mark of Brunswick Corporation.

## Mercury Premier Service

Mercury evaluates the service performance of its dealers and assigns its highest rating of "Mercury Premier" to those demonstrating an exceptional commitment to service.

### **Earning a Mercury Premier Service rating means a dealer:**

- Achieves a high 12 month service CSI (Customer Satisfaction Index) score for warranty service.
- Possesses all necessary service tools, test equipment, manuals, and parts books.
- Employs at least one Certified or Master technician.

- Provides timely service for all Mercury Marine customers.
- Offers extended service hours and mobile service, when appropriate.
- Uses, displays, and stocks adequate inventory of genuine Mercury Precision Parts.
- Offers a clean, neat shop with well organized tools and service literature.

**Declaration of Conformity 30/40/50/60 4-Stroke - For Recreational Craft Propulsion Engines with the Requirements of Directive 94/25/EC as amended by 2003/44/EC**

<b>Name of engine manufacturer:</b> Mercury Marine Technology Suzhou Co., Ltd.			
<b>Address:</b> No 200 Suhong Middle Road, Suzhou Industrial Park			
<b>Town:</b> Suzhou	<b>Post Code:</b> 215021	<b>Country:</b> CHINA	

<b>Name of Authorized Representative:</b> Brunswick Marine in EMEA Inc.			
<b>Address:</b> Parc Industriel de Petit-Rechain			
<b>Town:</b> Verviers	<b>Post Code:</b> 4800	<b>Country:</b> Belgium	

<b>Name of Notified Body for exhaust emission assessment:</b> Det Norske Veritas AS			
<b>Address:</b> Veritasveien 1			
<b>Town:</b> Hovik	<b>Post Code:</b> 1322	<b>Country:</b> Norway	<b>ID Number:</b> 0575

<b>Name of Notified Body for noise emission assessment:</b> Det Norske Veritas AS			
<b>Address:</b> Veritasveien 1			
<b>Town:</b> Hovik	<b>Post Code:</b> 1322	<b>Country:</b> Norway	<b>ID Number:</b> 0575

<b>Conformity assessment module used for exhaust emissions:</b>	<input type="checkbox"/> B+C	<input type="checkbox"/> B+D	<input type="checkbox"/> B+E	<input type="checkbox"/> B+F	<input type="checkbox"/> G	<input checked="" type="checkbox"/> H
<b>Conformity assessment module used for noise emissions:</b>	<input type="checkbox"/> A	<input type="checkbox"/> Aa	<input type="checkbox"/> G	<input checked="" type="checkbox"/> H		
<b>Other Community Directives applied: Safety of Machinery Directive 98/37/EC; Electromagnetic Compatibility Directive 2004/108/EC</b>						

## Description of Engines and Essential Requirements

Engine Type	Fuel Type	Combustion Cycle
<input type="checkbox"/> z or sterndrive with integral exhaust	<input type="checkbox"/> Diesel	<input type="checkbox"/> 2 stroke
<input checked="" type="checkbox"/> Outboard engine	<input checked="" type="checkbox"/> Petrol	<input checked="" type="checkbox"/> 4 stroke

## Identification of Engines Covered by This Declaration of Conformity

Name of engine family	Unique engine identification number: starting serial number	EC Module H certificate number
30, 40 hp 3 cylinder	OP401000, or 1C010000	RCD-H-2
40, 50, 60 hp 4 cylinder	OP401000, or 1C010000	RCD-H-2

Essential requirements	standards	other normative document/ method	technical file	Please specify in more detail (* = mandatory standard)
------------------------	-----------	----------------------------------	----------------	--

### Annex 1.B—Exhaust Emissions

B.1 engine identification	<input type="checkbox"/>	<input type="checkbox"/>	<input checked="" type="checkbox"/>	
B.2 exhaust emission requirements	<input checked="" type="checkbox"/> *	<input type="checkbox"/>	<input type="checkbox"/>	* EN ISO 8178-1:1996
B.3 durability	<input type="checkbox"/>	<input type="checkbox"/>	<input checked="" type="checkbox"/>	* EN ISO 8178-1:1996
B.4 owner's manual	<input checked="" type="checkbox"/>	<input type="checkbox"/>	<input type="checkbox"/>	EN ISO 8665: 1995

### Annex 1.C—Noise Emissions

C.1 Noise emission levels	<input checked="" type="checkbox"/> *	<input type="checkbox"/>	<input type="checkbox"/>	*EN ISO 14509
C.2 Owner's manual	<input type="checkbox"/>	<input checked="" type="checkbox"/>	<input type="checkbox"/>	Owner's manual

This declaration of conformity is issued under the sole responsibility of the manufacturer. I declare on behalf of the engine manufacturer that the engines mentioned preceding complies with all applicable essential requirements in the way specified.

**Name / function:**

Mark D. Schwabero, President, Mercury  
Outboard

A handwritten signature in black ink, reading "Mark D. Schwabero". The signature is written in a cursive style with a large, prominent initial 'M'.

**Date and place of issue:** July 24, 2008  
Fond du Lac, Wisconsin, USA



---

## WARRANTY INFORMATION

---

Warranty Registration.....	1
Transfer of Warranty.....	1
Transfer of Mercury Product Protection (Extended Service Coverage) Plan United States and Canada.....	2
FourStroke Outboard Limited Warranty.....	3
FourStroke Outboard Limited Warranty.....	6
FourStroke Outboard Limited Warranty.....	10
3 Year Limited Warranty Against Corrosion.....	13
Warranty Coverage and Exclusions.....	17
U.S. EPA Emissions Limited Warranty.....	19
Emission Control System Components.....	19
California Emissions Limited Warranty.....	20
California Air Resources Board Explanation of Your California Emission Control Warranty Statement.....	24
Emission Certification Star Label.....	25

---

## GENERAL INFORMATION

---

Boater's Responsibilities.....	27
Before Operating Your Outboard.....	27
Boat Horsepower Capacity.....	28
High-Speed and High-Performance Boat Operation.....	28
Outboard Remote Control Models .....	28
Remote Steering Notice.....	29
Lanyard Stop Switch.....	30
Protecting People in the Water.....	33
Passenger Safety Message - Pontoon Boats and Deck Boats..	34
Wave and Wake Jumping.....	35
Impact with Underwater Hazards.....	36
Safety Instructions for Hand-Tilled Outboards.....	37
Exhaust Emissions.....	38
Selecting Accessories for Your Outboard.....	41
Safe Boating Suggestions.....	41
Recording Serial Number.....	43
40/50/60 FourStroke Specifications.....	43
Component Identification.....	45

---

## TRANSPORTING

---

Trailing Boat/Outboard .....	46
Transporting Portable Fuel Tanks.....	47

---

## FUEL & OIL

---

Fuel Recommendations.....	48
Low Permeation Fuel Hose Requirement .....	50
Filling Fuel Tank.....	50
Engine Oil Recommendations.....	51
Checking and Adding Engine Oil.....	51



---

## FEATURES & CONTROLS

---

Remote Control Features.....	53
Warning System.....	54
Power Trim and Tilt.....	56
Throttle Grip Friction Adjustment - Tiller Handle Models.....	60
Steering Friction Adjustment - Tiller Handle Models.....	60
Trim Tab Adjustment.....	61

---

## OPERATION

---

Pre-Starting Check List.....	63
Operating in Freezing Temperatures.....	63
Operating in Saltwater or Polluted Water.....	63
Pre-Starting Instructions.....	64
Engine Break-in Procedure.....	65
Starting the Engine - Remote Control Models.....	65
Starting the Engine - Tiller Handle Models.....	68
Gear Shifting .....	71
Stopping the Engine .....	72
Emergency Starting .....	73

---

## MAINTENANCE

---

Outboard Care.....	75
EPA Emissions Regulations.....	75
Inspection and Maintenance Schedule.....	76
Flushing the Cooling System.....	78
Top Cowl Removal and Installation.....	80
Exterior Care.....	80
Battery Inspection .....	81
Fuel System.....	81
Steering Link Rod Fasteners.....	83
Corrosion Control Anode.....	84
Propeller Replacement - 87.3 mm(3-7/16 in.) Diameter Gearcase .....	85
Propeller Replacement - 108 mm(4-1/4 in.) Diameter Gearcase .....	88
Spark Plug Inspection and Replacement.....	92
Fuse Replacement.....	93
Timing Belt Inspection.....	94
Lubrication Points.....	95
Checking Power Trim Fluid.....	98
Changing Engine Oil .....	98
Gearcase Lubrication - For 87.3 mm(3-7/16 in.) Diameter Gearcase.....	100
Gearcase Lubrication - For 108 mm(4-1/4 in.) Diameter Gearcase .....	102
Submerged Outboard.....	104

---

## STORAGE

---

Storage Preparation.....	105
Protecting External Outboard Components.....	106
Protecting Internal Engine Components.....	106
Gearcase.....	106
Positioning Outboard for Storage.....	106
Battery Storage.....	107

---

## TROUBLESHOOTING

---

Starter Motor Will Not Crank the Engine (Electric Start Models)	108
Engine Will Not Start.....	108
Engine Runs Erratically.....	109
Performance Loss.....	109
Battery Will Not Hold Charge.....	109

---

## OWNER SERVICE ASSISTANCE

---

Local Repair Service.....	111
Service Away from Home.....	111
Parts and Accessories Inquiries.....	111
Service Assistance.....	111
Mercury Marine Service Offices.....	112

---

## OUTBOARD INSTALLATION

---

Installation Information.....	114
Fuel Hose Connection - Remote Control Models.....	124
Electrical Connections and Control Cable Installation.....	125
Propeller Installation.....	133
Trim Tab Adjustment.....	138
Trim-In Stop Adjustment - Power Trim Models.....	139

---

## MAINTENANCE LOG

---

Maintenance Log.....	140
----------------------	-----



# WARRANTY INFORMATION

## Warranty Registration

### UNITED STATES AND CANADA

To be eligible for warranty coverage, the product must be registered with Mercury Marine.

At the time of sale, the selling dealer should complete the warranty registration and immediately submit it to Mercury Marine via MercNET, e-mail, or mail. Upon receipt of this warranty registration, Mercury Marine will record the registration.

A copy of the warranty registration should be provided to you by your selling dealer.

***NOTE: Registration lists must be maintained by Mercury Marine and any dealer on marine products sold in the United States, should a safety recall notification under the Federal Safety Act be required.***

You may change your address at any time, including at time of warranty claim, by calling Mercury Marine or sending a letter or fax with your name, old address, new address, and engine serial number to Mercury Marine's warranty registration department. Your dealer can also process this change of information.

Mercury Marine

Attn: Warranty Registration Department

W6250 W. Pioneer Road

P.O. Box 1939

Fond du Lac, WI 54936-1939

920-929-5054

Fax +1 920 929 5893

### OUTSIDE UNITED STATES AND CANADA

For products purchased outside the United States and Canada, contact the distributor in your country, or the Marine Power Service Center closest to you.

## Transfer of Warranty

### UNITED STATES AND CANADA

The limited warranty is transferable to a subsequent purchaser, but only for the remainder of the unused portion of the limited warranty. This will not apply to products used for commercial applications.

# WARRANTY INFORMATION

To transfer the warranty to the subsequent owner, send or fax a copy of the bill of sale or purchase agreement, new owner's name, address, and engine serial number to Mercury Marine's warranty registration department. In the United States and Canada, mail to:

Mercury Marine  
Attn: Warranty Registration Department  
W6250 W. Pioneer Road  
P.O. Box 1939  
Fond du Lac, WI 54936-1939  
920-929-5054  
Fax +1 920 929 5893

Upon processing the transfer of warranty, Mercury Marine will record the new owner's information.

There is no charge for this service.

## **OUTSIDE THE UNITED STATES AND CANADA**

For products purchased outside the United States and Canada, contact the distributor in your country, or the Marine Power Service Center closest to you.

## **Transfer of Mercury Product Protection (Extended Service Coverage) Plan United States and Canada**

The remaining coverage period of the Product Protection Plan is transferable to the subsequent purchaser of the engine within thirty (30) days from the date of sale. Contracts not transferred within thirty (30) days of the subsequent purchase will no longer be valid and the product will no longer be eligible for coverage under the terms of the contract.

To transfer the plan to the subsequent owner, contact Mercury Product Protection or an authorized dealer to receive a Request for Transfer form. Submit to Mercury Product Protection a receipt/bill of sale, a completed Request of Transfer form, and a check payable to Mercury Marine in the amount of \$50.00 (per engine) to cover the transfer fee.

Plan coverage is not transferable from one product to another product or for non-eligible applications.

The Certified Pre-Owned engine plans are not transferable.

# WARRANTY INFORMATION

For help or assistance, contact Mercury Product Protection Department at 1-888-427-5373 from 7:30 a.m. to 4:30 p.m. CST, Monday–Friday or email [mpp\\_support@mercmarine.com](mailto:mpp_support@mercmarine.com).

## FourStroke Outboard Limited Warranty

### UNITED STATES AND CANADA

*Outside the United States and Canada - Check with your local distributor.*

**WHAT IS COVERED:** Mercury Marine warrants its new products to be free of defects in material and workmanship during the period described below.

**DURATION OF COVERAGE:** This Limited Warranty provides coverage for three (3) years from the date the product is first sold to a recreational use retail purchaser, or the date on which the product is first put into service, whichever occurs first. Commercial users of these products receive warranty coverage of one (1) year from the date of first retail sale, or one (1) year from the date on which the product was first put into service, whichever occurs first. Commercial use is defined as any work or employment related use of the product, or any use of the product which generates income, for any part of the warranty period, even if the product is only occasionally used for such purposes. The repair or replacement of parts, or the performance of service under this warranty, does not extend the life of this warranty beyond its original expiration date. Unexpired warranty coverage can be transferred from one recreational use customer to a subsequent recreational use customer upon proper reregistration of the product. Unexpired warranty coverage cannot be transferred either to or from a commercial use customer. Warranty coverage may be terminated for used repossessed product; or product purchased at auction, from a salvage yard, or from an insurance company.

# WARRANTY INFORMATION

## **CONDITIONS THAT MUST BE MET IN ORDER TO OBTAIN**

**WARRANTY COVERAGE:** Warranty coverage is available only to retail customers that purchase from a Dealer authorized by Mercury Marine to distribute the product in the country in which the sale occurred, and then only after the Mercury Marine specified pre-delivery inspection process is completed and documented. Warranty coverage becomes available upon proper registration of the product by the authorized dealer. Inaccurate warranty registration information regarding recreational use, or subsequent change of use from recreational to commercial (unless properly reregistered) may void the warranty at the sole discretion of Mercury Marine. Routine maintenance outlined in the Operation and Maintenance Manual must be timely performed in order to maintain warranty coverage. Mercury Marine reserves the right to make warranty coverage contingent upon proof of proper maintenance.

**WHAT MERCURY WILL DO:** Mercury's sole and exclusive obligation under this warranty is limited to, at our option, repairing a defective part, replacing such part or parts with new or Mercury Marine certified remanufactured parts, or refunding the purchase price of the Mercury product. Mercury reserves the right to improve or modify products from time to time without assuming an obligation to modify products previously manufactured.

**HOW TO OBTAIN WARRANTY COVERAGE:** The customer must provide Mercury with a reasonable opportunity to repair, and reasonable access to the product for warranty service. Warranty claims shall be made by delivering the product for inspection to a Mercury dealer authorized to service the product. If purchaser cannot deliver the product to such a dealer, written notice must be given to Mercury. We will then arrange for the inspection and any covered repair. Purchaser, in that case, shall pay for all related transportation charges and/or travel time. If the service provided is not covered by this warranty, purchaser shall pay for all related labor and material, and any other expenses associated with that service. Purchaser shall not, unless requested by Mercury, ship the product or parts of the product directly to Mercury. Proof of registered ownership must be presented to the dealer at the time warranty service is requested in order to obtain coverage.



## WARRANTY INFORMATION

**WHAT IS NOT COVERED:** This limited warranty does not cover routine maintenance items, tune-ups, adjustments, normal wear and tear, damage caused by abuse, abnormal use, use of a propeller or gear ratio that does not allow the engine to run in its recommended wide-open throttle RPM range (see the Operation and Maintenance Manual), operation of the product in a manner inconsistent with the recommended operation/duty cycle section of the Operation and Maintenance Manual, neglect, accident, submersion, improper installation (proper installation specifications and techniques are set forth in the installation instructions for the product), improper service, use of an accessory or part not manufactured or sold by us, jet pump impellers and liners, operation with fuels, oils, or lubricants which are not suitable for use with the product (see the Operation and Maintenance Manual), alteration or removal of parts, water entering the engine through the fuel intake, air intake or exhaust system, or damage to the product from insufficient cooling water caused by blockage of the cooling system by a foreign body, running the engine out of water, mounting the engine too high on the transom, or running the boat with the engine trimmed out too far. Use of the product for racing or other competitive activity, or operating with a racing type lower unit, at any point, even by a prior owner of the product, voids the warranty.

Expenses related to haul-out, launch, towing, storage, telephone, rental, inconvenience, slip fees, insurance coverage, loan payments, loss of time, loss of income, or any other type of incidental or consequential damages are not covered by this warranty. Also, expenses associated with the removal and/or replacement of boat partitions or material caused by boat design for access to the product are not covered by this warranty.

No individual or entity, including Mercury Marine authorized dealers, has been given authority by Mercury Marine to make any affirmation, representation, or warranty regarding the product, other than those contained in this limited warranty, and if made, shall not be enforceable against Mercury Marine.

# WARRANTY INFORMATION

For additional information regarding events and circumstances covered by this warranty, and those that are not, see the Warranty Coverage section of the Operation and Maintenance Manual, incorporated by reference into this warranty.

## DISCLAIMERS AND LIMITATIONS:

THE IMPLIED WARRANTIES OF MERCHANTABILITY AND FITNESS FOR A PARTICULAR PURPOSE ARE EXPRESSLY DISCLAIMED. TO THE EXTENT THAT THEY CANNOT BE DISCLAIMED, THE IMPLIED WARRANTIES ARE LIMITED IN DURATION TO THE LIFE OF THE EXPRESS WARRANTY. INCIDENTAL AND CONSEQUENTIAL DAMAGES ARE EXCLUDED FROM COVERAGE UNDER THIS WARRANTY. SOME STATES/COUNTRIES DO NOT ALLOW FOR THE DISCLAIMED, LIMITATIONS AND EXCLUSIONS IDENTIFIED ABOVE, AS A RESULT, THEY MAY NOT APPLY TO YOU. THIS WARRANTY GIVES YOU SPECIFIC LEGAL RIGHTS, AND YOU MAY ALSO HAVE OTHER LEGAL RIGHTS WHICH VARY FROM STATE TO STATE AND COUNTRY TO COUNTRY.

## FourStroke Outboard Limited Warranty

### EUROPE AND CONFEDERATION OF INDEPENDENT STATES

Outside Europe and Confederation of Independent States - check with local distributor.

**WHAT IS COVERED:** Mercury Marine warrants its new products to be free of defects in material and workmanship during the period described below.

# WARRANTY INFORMATION

**DURATION OF COVERAGE:** This Limited Warranty provides coverage for two (2) years from the date the product is first sold to a recreational use retail purchaser, or the date on which the product is first put into service, whichever occurs first. Commercial users of these products receive warranty coverage of one (1) year from the date of first retail sale, or one (1) year from the date in which the product was first put into service, whichever occurs first. Commercial use is defined as any work or employment related use of the product, or any use of the product which generates income, for any part of the warranty period, even if the product is only occasionally used for such purposes. The repair or replacement of parts, or the performance of service under this warranty, does not extend the life of this warranty beyond its original expiration date. Unexpired warranty coverage can be transferred from one recreational use customer to a subsequent recreational use customer upon proper reregistration of the product. Unexpired warranty coverage cannot be transferred either to or from a commercial use customer. Warranty coverage may be terminated for used or repossessed product; or product purchased at auction, from a salvage yard, or from an insurance company.

**CONDITIONS THAT MUST BE MET IN ORDER TO OBTAIN WARRANTY COVERAGE:** Warranty coverage is available only to retail customers that purchase from a Dealer authorized by Mercury Marine to distribute the product in the country in which the sale occurred, and then only after the Mercury Marine specified predelivery inspection process is completed and documented. Warranty coverage becomes available upon proper registration of the product by the authorized dealer. Routine maintenance outlined in the Operation and Maintenance Manual must be timely performed in order to maintain warranty coverage. Mercury Marine reserves the right to make future warranty coverage contingent on proof of proper maintenance.

# WARRANTY INFORMATION

**WHAT MERCURY WILL DO:** Mercury's sole and exclusive obligation under this warranty is limited to, at our option, repairing a defective part, replacing such part or parts with new or Mercury Marine certified remanufactured parts, or refunding the purchase price of the Mercury product. Mercury reserves the right to improve or modify products from time to time without assuming an obligation to modify products previously manufactured.

**HOW TO OBTAIN WARRANTY COVERAGE:** The customer must provide Mercury with a reasonable opportunity to repair, and reasonable access to the product for warranty service. Warranty claims shall be made by delivering the product for inspection to a Mercury dealer authorized to service the product. If purchaser cannot deliver the product to such a dealer, written notice must be given to Mercury. We will then arrange for the inspection and any covered repair. Purchaser in that case shall pay for all related transportation charges and/or travel time. If the service provided is not covered by this warranty, purchaser shall pay for all related labor and material, and any other expenses associated with that service. Purchaser shall not, unless requested by Mercury, ship the product or parts of the product directly to Mercury. Proof of registered ownership must be presented to the dealer at the time warranty service is requested in order to obtain coverage.

# WARRANTY INFORMATION

**WHAT IS NOT COVERED:** This limited warranty does not cover routine maintenance items, tune-ups, adjustments, normal wear and tear, damage caused by abuse, abnormal use, use of a propeller or gear ratio that does not allow the engine to run in its recommended wide-open throttle RPM range (see the Operation and Maintenance Manual), operation of the product in a manner inconsistent with the recommended operation/duty cycle section of the Operation and Maintenance Manual, neglect, accident, submersion, improper installation (proper installation specifications and techniques are set forth in the installation instructions for the product), improper service, use of an accessory or part not manufactured or sold by us, jet pump impellers and liners, operation with fuels, oils or lubricants which are not suitable for use with the product (see the Operation and Maintenance Manual), alteration or removal of parts, or water entering the engine through the fuel intake, air intake or exhaust system, or damage to the product from insufficient cooling water caused by blockage of the cooling system by a foreign body, running the engine out of water, mounting the engine too high on the transom, or running the boat with the engine trimmed out too far. Use of the product for racing or other competitive activity, or operating with a racing type lower unit, at any point, even by a prior owner of the product, voids the warranty.

Expenses related to haul out, launch, towing, storage, telephone, rental, inconvenience, slip fees, insurance coverage, loan payments, loss of time, loss of income, or any other type of incidental or consequential damages are not covered by this warranty. Also, expenses associated with the removal and/or replacement of boat partitions or material caused by boat design for access to the product are not covered by this warranty.

No individual or entity, including Mercury Marine authorized dealers, has been given authority by Mercury Marine to make any affirmation, representation or warranty regarding the product, other than those contained in this limited warranty, and if made, shall not be enforceable against Mercury Marine.

# WARRANTY INFORMATION

For additional information regarding events and circumstances covered by this warranty, and those that are not, see the Warranty Coverage section of the Operation and Maintenance Manual, incorporated by reference into this warranty.

## DISCLAIMERS AND LIMITATIONS:

THE IMPLIED WARRANTIES OF MERCHANTABILITY AND FITNESS FOR A PARTICULAR PURPOSE ARE EXPRESSLY DISCLAIMED. TO THE EXTENT THAT THEY CANNOT BE DISCLAIMED, THE IMPLIED WARRANTIES ARE LIMITED IN DURATION TO THE LIFE OF THE EXPRESS WARRANTY. INCIDENTAL AND CONSEQUENTIAL DAMAGES ARE EXCLUDED FROM COVERAGE UNDER THIS WARRANTY. SOME STATES/COUNTRIES DO NOT ALLOW FOR THE DISCLAIMERS, LIMITATIONS AND EXCLUSIONS IDENTIFIED ABOVE, AS A RESULT, THEY MAY NOT APPLY TO YOU. THIS WARRANTY GIVES YOU SPECIFIC LEGAL RIGHTS, AND YOU MAY ALSO HAVE OTHER LEGAL RIGHTS WHICH VARY FROM STATE TO STATE AND COUNTRY TO COUNTRY.

## FourStroke Outboard Limited Warranty

### MIDDLE-EAST AND AFRICA

**WHAT IS COVERED:** Mercury Marine warrants its new Outboard and Jet Products to be free of defects in material and workmanship during the period described below.

# WARRANTY INFORMATION

**DURATION OF COVERAGE:** This Limited Warranty provides coverage for one (1) year from the date the product is first sold to a recreational use retail purchaser, or the date on which the product is first put into service, whichever occurs first. Commercial users of these products receive warranty coverage of one (1) years from the date of first retail sale, or one (1) year from the date on which the product was first put into service, whichever occurs first. Commercial use is defined as any work or employment related use of the product, or any use of the product which generates income, for any part of the warranty period, even if the product is only occasionally used for such purposes. The repair or replacement of parts, or the performance of service under this warranty, does not extend the life of this warranty beyond its original expiration date. Unexpired warranty coverage can be transferred from one recreational use customer to a subsequent recreational use customer upon proper reregistration of the product. Unexpired warranty coverage cannot be transferred either to or from a commercial use customer.

**CONDITIONS THAT MUST BE MET IN ORDER TO OBTAIN WARRANTY COVERAGE:** Warranty coverage is available only to retail customers that purchase from a Dealer authorized by Mercury Marine to distribute the product in the country in which the sale occurred, and then only after the Mercury Marine specified predelivery inspection process is completed and documented. Warranty coverage becomes available upon proper registration of the product by the authorized dealer. Routine maintenance outlined in the Operation and Maintenance Manual must be timely performed in order to maintain warranty coverage. Mercury Marine reserves the right to make warranty coverage contingent on proof of proper maintenance.

**WHAT MERCURY WILL DO:** Mercury's sole and exclusive obligation under this warranty is limited to, at our option, repairing a defective part, replacing such part or parts with new or Mercury Marine certified remanufactured parts, or refunding the purchase price of the Mercury product. Mercury reserves the right to improve or modify products from time to time without assuming an obligation to modify products previously manufactured.

# WARRANTY INFORMATION

**HOW TO OBTAIN WARRANTY COVERAGE:** The customer must provide Mercury with a reasonable opportunity to repair, and reasonable access to the product for warranty service. Warranty claims shall be made by delivering the product for inspection to a Mercury dealer authorized to service the product. If purchaser cannot deliver the product to such a dealer, written notice must be given to Mercury. We will then arrange for the inspection and any covered repair. Purchaser in that case shall pay for all related transportation charges and/or travel time. If the service provided is not covered by this warranty, purchaser shall pay for all related labor and material, and any other expenses associated with that service. Purchaser shall not, unless requested by Mercury, ship the product or parts of the product directly to Mercury. Proof of registered ownership must be presented to the dealer at the time warranty service is requested in order to obtain coverage.

**WHAT IS NOT COVERED:** This limited warranty does not cover routine maintenance items, tune-ups, adjustments, normal wear and tear, damage caused by abuse, abnormal use, use of a propeller or gear ratio that does not allow the engine to run in its recommended wide-open throttle RPM range (see the Operation and Maintenance Manual), operation of the product in a manner inconsistent with the recommended operation/duty cycle section of the Operation and Maintenance Manual, neglect, accident, submersion, improper installation (proper installation specifications and techniques are set forth in the installation instructions for the product), improper service, use of an accessory or part not manufactured or sold by us, jet pump impellers and liners, operation with fuels, oils or lubricants which are not suitable for use with the product (see the Operation and Maintenance Manual), alteration or removal of parts, or water entering the engine through the fuel intake, air intake or exhaust system, or damage to the product from insufficient cooling water caused by blockage of the cooling system by foreign body, running the engine out of water, mounting the engine too high on the transom, or running the boat with the engine trimmed out too far.

Use of the product for racing or other competitive activity, or operating with a racing type lower unit, at any point, even by a prior owner of the product, voids the warranty.



# WARRANTY INFORMATION

Expenses related to haul out, launch, towing, storage, telephone, rental, inconvenience, slip fees, insurance coverage, loan payments, loss of time, loss of income, or any other type of incidental or consequential damages are not covered by this warranty. Also, expenses associated with the removal and/or replacement of boat partitions or material caused by boat design for access to the product are not covered by this warranty.

No individual or entity, including Mercury Marine authorized dealers, has been given authority by Mercury Marine to make any affirmation, representation or warranty regarding the product, other than those contained in this limited warranty, and if made, shall not be enforceable against Mercury Marine.

For additional information regarding events and circumstances covered by this warranty, and those that are not, see the Warranty Coverage section of the Operation and Maintenance Manual, incorporated by reference into this warranty.

## DISCLAIMERS AND LIMITATIONS:

THE IMPLIED WARRANTIES OF MERCHANTABILITY AND FITNESS FOR A PARTICULAR PURPOSE ARE EXPRESSLY DISCLAIMED. TO THE EXTENT THAT THEY CANNOT BE DISCLAIMED, THE IMPLIED WARRANTIES ARE LIMITED IN DURATION TO THE LIFE OF THE EXPRESS WARRANTY. INCIDENTAL AND CONSEQUENTIAL DAMAGES ARE EXCLUDED FROM COVERAGE UNDER THIS WARRANTY. SOME STATES/COUNTRIES DO NOT ALLOW FOR THE DISCLAIMERS, LIMITATIONS AND EXCLUSIONS IDENTIFIED ABOVE, AS A RESULT, THEY MAY NOT APPLY TO YOU. THIS WARRANTY GIVES YOU SPECIFIC LEGAL RIGHTS, AND YOU MAY ALSO HAVE OTHER LEGAL RIGHTS WHICH VARY FROM STATE TO STATE AND COUNTRY TO COUNTRY.

## 3 Year Limited Warranty Against Corrosion

**WHAT IS COVERED:** Mercury Marine warrants that each new Mercury, Mariner, Mercury Racing, Sport Jet, M<sup>2</sup> Jet Drive, Tracker by Mercury Marine Outboard, Mercury MerCruiser Inboard or Sterndrive Engine (Product) will not be rendered inoperative as a direct result of corrosion for the period of time described below.

# WARRANTY INFORMATION

**DURATION OF COVERAGE:** This limited corrosion warranty provides coverage for three (3) years from either the date the product is first sold, or the date on which the product is first put into service, whichever occurs first. The repair or replacement of parts, or the performance of service under this warranty, does not extend the life of this warranty beyond its original expiration date. Unexpired warranty coverage can be transferred to subsequent (noncommercial use) purchaser upon proper reregistration of the product.

**CONDITIONS THAT MUST BE MET IN ORDER TO OBTAIN WARRANTY COVERAGE:** Warranty coverage is available only to retail customers that purchase from a Dealer authorized by Mercury Marine to distribute the product in the country in which the sale occurred, and then only after the Mercury Marine specified predelivery inspection process is completed and documented. Warranty coverage becomes available upon proper registration of the product by the authorized dealer. Corrosion prevention devices specified in the Operation and Maintenance Manual must be in use on the boat, and routine maintenance outlined in the Operation and Maintenance Manual must be timely performed (including, without limitation, the replacement of sacrificial anodes, use of specified lubricants, and touch-up of nicks and scratches) in order to maintain warranty coverage. Mercury Marine reserves the right to make warranty coverage contingent upon proof of proper maintenance.

**WHAT MERCURY WILL DO:** Mercury's sole and exclusive obligation under this warranty is limited to, at our option, repairing a corroded part, replacing such part or parts with new or Mercury Marine certified remanufactured parts, or refunding the purchase price of the Mercury product. Mercury reserves the right to improve or modify products from time to time without assuming an obligation to modify products previously manufactured.

## WARRANTY INFORMATION

**HOW TO OBTAIN WARRANTY COVERAGE:** The customer must provide Mercury with a reasonable opportunity to repair, and reasonable access to the product for warranty service. Warranty claims shall be made by delivering the product for inspection to a Mercury dealer authorized to service the product. If purchaser cannot deliver the product to such a dealer, written notice must be given to Mercury. We will then arrange for the inspection and any covered repair. Purchaser, in that case, shall pay for all related transportation charges and/or travel time. If the service provided is not covered by this warranty, purchaser shall pay for all related labor and material, and any other expenses associated with that service. Purchaser shall not, unless requested by Mercury, ship the product or parts of the product directly to Mercury. Proof of registered ownership must be presented to the dealer at the time warranty service is requested in order to obtain coverage.

**WHAT IS NOT COVERED:** This limited warranty does not cover electrical system corrosion; corrosion resulting from damage, corrosion which causes purely cosmetic damage, abuse, or improper service; corrosion to accessories, instruments, steering systems; corrosion to factory installed jet drive unit; damage due to marine growth; product sold with less than a one year limited Product warranty; replacement parts (parts purchased by customer); products used in a commercial application. Commercial use is defined as any work or employment related use of the product, or any use of the product which generates income, for any part of the warranty period, even if the product is only occasionally used for such purposes.

## WARRANTY INFORMATION

Corrosion damage caused by stray electrical currents (onshore power connections, nearby boats, submerged metal) is not covered by this corrosion warranty and should be protected against by the use of a corrosion protection system, such as the Mercury Precision Parts or Quicksilver MerCathode system and/or Galvanic Isolator. Corrosion damage caused by improper application of copper base antifouling paints is also not covered by this limited warranty. If antifouling protection is required, Tri-Butyl-Tin-Adipate (TBTA) base antifouling paints are recommended on Outboard and MerCruiser boating applications. In areas where TBTA base paints are prohibited by law, copper base paints can be used on the hull and transom. Do not apply paint to the outboard or MerCruiser product. In addition, care must be taken to avoid an electrical interconnection between the warranted product and the paint. For MerCruiser product, an unpainted gap of at least 38 mm (1.5 in.) should be left around the transom assembly. Refer to the Operation and Maintenance Manual for additional details.

For additional information regarding events and circumstances covered by this warranty, and those that are not, see the Warranty Coverage section of the Operation and Maintenance Manual, incorporated by reference into this warranty.

### **DISCLAIMERS AND LIMITATIONS:**

**THE IMPLIED WARRANTIES OF MERCHANTABILITY AND FITNESS FOR A PARTICULAR PURPOSE ARE EXPRESSLY DISCLAIMED. TO THE EXTENT THAT THEY CANNOT BE DISCLAIMED, THE IMPLIED WARRANTIES ARE LIMITED IN DURATION TO THE LIFE OF THE EXPRESS WARRANTY. INCIDENTAL AND CONSEQUENTIAL DAMAGES ARE EXCLUDED FROM COVERAGE UNDER THIS WARRANTY. SOME STATES/COUNTRIES DO NOT ALLOW FOR THE DISCLAIMERS, LIMITATIONS AND EXCLUSIONS IDENTIFIED ABOVE, AS A RESULT, THEY MAY NOT APPLY TO YOU. THIS WARRANTY GIVES YOU SPECIFIC LEGAL RIGHTS, AND YOU MAY ALSO HAVE OTHER LEGAL RIGHTS WHICH VARY FROM STATE TO STATE AND COUNTRY TO COUNTRY.**

# WARRANTY INFORMATION

## Warranty Coverage and Exclusions

The purpose of this section is to help eliminate some of the more common misunderstandings regarding warranty coverage. The following information explains some of the types of services that are not covered by warranty. The provisions set forth following have been incorporated by reference into the Three Year Limited Warranty Against Corrosion Failure, the International Limited Outboard Warranty, and the United States and Canada Limited Outboard Warranty.

Keep in mind that warranty covers repairs that are needed within the warranty period because of defects in material and workmanship. Installation errors, accidents, normal wear, and a variety of other causes that affect the product are not covered.

Warranty is limited to defects in material or workmanship, but only when the consumer sale is made in the country to which distribution is authorized by us.

Should you have any questions concerning warranty coverage, contact your authorized dealer. They will be pleased to answer any questions that you may have.

## GENERAL EXCLUSIONS FROM WARRANTY

1. Minor adjustments and tune-ups, including checking, cleaning, or adjusting spark plugs, ignition components, carburetor settings, filters, belts, controls, and checking lubrication made in connection with normal services.
2. Factory installed jet drive units - Specific parts excluded from the warranty are: the jet drive impeller and jet drive liner damaged by impact or wear, and water damaged driveshaft bearings as a result of improper maintenance.
3. Damage caused by neglect, lack of maintenance, accident, abnormal operation, or improper installation or service.
4. Haul-out, launch, towing charges, removal and/or replacement of boat partitions or material because of boat design for necessary access to the product, all related transportation charges and/or travel time, etc. Reasonable access must be provided to the product for warranty service. Customer must deliver product to an authorized dealer.

# WARRANTY INFORMATION

5. Additional service work requested by customer other than that necessary to satisfy the warranty obligation.
6. Labor performed by other than an authorized dealer may be covered only under the following circumstances: when performed on emergency basis (providing there are no authorized dealers in the area who can perform the work required or have no facilities to haul-out, etc., and prior factory approval has been given to have the work performed at this facility).
7. All incidental and/or consequential damages (storage charges, telephone or rental charges of any type, inconvenience or loss of time or income) are the owner's responsibility.
8. Use of other than Mercury Precision or Quicksilver parts when making warranty repairs.
9. Oils, lubricants, or fluids changed as a matter of normal maintenance is customer's responsibility unless loss or contamination of same is caused by product failure that would be eligible for warranty consideration.
10. Participating in or preparing for racing or other competitive activity or operating with a racing type lower unit.
11. Engine noise does not necessarily indicate a serious engine problem. If diagnosis indicates a serious internal engine condition which could result in a failure, condition responsible for noise should be corrected under the warranty.
12. Lower unit and/or propeller damage caused by striking a submerged object is considered a marine hazard.
13. Water entering engine through the fuel intake, air intake, or exhaust system or submersion.
14. Failure of any parts caused by lack of cooling water, which results from starting motor out of water, foreign material blocking inlet holes, motor being mounted too high, or trimmed too far out.
15. Use of fuels and lubricants which are not suitable for use with or on the product. Refer to the **Maintenance** section.

# WARRANTY INFORMATION

16. Our limited warranty does not apply to any damage to our products caused by the installation or use of parts and accessories which are not manufactured or sold by us. Failures which are not related to the use of those parts or accessories are covered under warranty if they otherwise meet the terms of the limited warranty for that product.

## U.S. EPA Emissions Limited Warranty

Consistent with the obligations created by 40 CFR Part 1045, Subpart B, Mercury Marine provides a five year or 175 hours of engine use, whichever occurs first, to the retail customer, that the engine is designed, built, and equipped so as to conform at the time of sale with applicable regulations under section 213 of the Clean Air Act, and that the engine is free from defects in materials and workmanship which cause the engine to fail to conform with applicable regulations. This emission-related warranty covers all the components listed in the **Emission Control System Components**.

## Emission Control System Components

The EPA and California emission-related warranty covers all the following list of components:

### COMPONENTS OF THE EMISSIONS CONTROL SYSTEM:

1. Fuel metering system
  - a. Carburetor and internal parts (and/or pressure regulator or fuel injection system)
  - b. Cold start enrichment system
  - c. Intake valves
2. Air induction system
  - a. Intake manifold
  - b. Turbocharger or supercharger systems (where applicable)
3. Ignition system
  - a. Spark plugs
  - b. Magneto or electronic ignition system
  - c. Spark advance/retard system
  - d. Ignition coil and/or control module

# WARRANTY INFORMATION

- e. Ignition wires
- 4. Lubrication system (4-Stroke engines excluded)
  - a. Oil pump and internal parts
  - b. Oil injectors
  - c. Oil meter
- 5. Exhaust system
  - a. Exhaust manifold
  - b. Exhaust valves
- 6. Miscellaneous items used in above systems
  - a. Hoses, clamps, fittings, tubing, sealing gaskets or devices, and mounting hardware
  - b. Pulleys, belts, and idlers
  - c. Vacuum, temperature, check and time sensitive valves and switches
  - d. Electronic controls

The emission-related warranty does not cover components whose failure would not increase an engine's emissions on any regulated pollutant.

## California Emissions Limited Warranty

The California Air Resources Board has promulgated air emission regulations for outboard engines. The regulations apply to all outboard engines sold to retail consumers in California, and which were manufactured for the 2001 model year and later. Mercury Marine, in compliance with those regulations, provides this limited warranty for the emission control systems (see the components listed in the **Emission Control System Components**), and further warrants that the outboard engine was designed, built, and equipped to conform with all applicable regulations adopted by the California Air Resources Board pursuant to its authority in Chapters 1 and 2, Part 5, Division 26 of the Health and Safety Code. For information regarding the limited warranty for the nonemission-related components of the outboard, please see the limited warranty statement for your outboard.



## WARRANTY INFORMATION

**WHAT IS COVERED:** Mercury Marine warrants the components of the emissions control systems (see the components listed in the **Emission Control System Components**) of its new, 2001 model year and later outboards, sold by a California dealer to retail customers residing in California, to be free from defects in material or workmanship, that cause the failure of a warranted part to be identical in all material respects to that part as described in the application of Mercury Marine for certification from the California Air Resources Board, for the period of time, and under the conditions, identified below. The cost to diagnose a warranty failure is covered under the warranty (if the warranty claim is approved). Damage to other engine components caused by the failure of a warranted part will also be repaired under warranty.

**DURATION OF COVERAGE:** This limited warranty provides coverage for the components of the emissions control systems of new, 2001 model year and later outboards, sold to retail customers in California for four (4) years from either the date the product is first sold, or first put into service, whichever occurs first, or the accumulation of 250 hours of engine operation (as determined by the engine's hour meter, if any). Emission-related normal maintenance items such as spark plugs and filters, that are on the warranted parts list, are warranted up to their first required replacement interval only. Refer to **Emission Control System Components and Maintenance Schedule**. The repair or replacement of parts, or the performance of service under this warranty, does not extend the life of this warranty beyond its original expiration date. Unexpired warranty coverage can be transferred to a subsequent purchaser. (See instructions on transfer of warranty.)

# WARRANTY INFORMATION

**HOW TO OBTAIN WARRANTY COVERAGE:** The customer must provide Mercury with a reasonable opportunity to repair and reasonable access to the product for warranty service. Warranty claims shall be made by delivering the product for inspection to a Mercury dealer authorized to service the product. If purchaser cannot deliver the product to such a dealer, please notify Mercury Marine and Mercury will then arrange for the inspection and any covered repair. Purchaser, in that case, shall pay for all related transportation charges and/or travel time. If the service provided is not covered by this warranty, purchaser shall pay for all related labor and material, and any other expenses associated with that service. Purchaser shall not, unless requested by Mercury, ship the product or parts of the product directly to Mercury.

**WHAT MERCURY WILL DO:** Mercury Marine's sole and exclusive obligation under this warranty is limited to, at our expense and at our option, repairing or replacing defective parts with new or Mercury Marine certified remanufactured parts, or refunding the purchase price of the Mercury product. Mercury reserves the right to improve or modify products from time to time without assuming an obligation to modify products previously manufactured.

**WHAT IS NOT COVERED:** This limited warranty does not cover routine maintenance items, tune-ups, adjustments, normal wear and tear, damage caused by abuse, abnormal use, use of a propeller or gear ratio that does not allow the engine to run in its recommended wide-open throttle RPM range (see **General Information - Specifications**), operation of the product in a manner inconsistent with the recommended operation procedures, neglect, accident, submersion, improper installation (proper installation specifications and techniques are set forth in the installation instructions for the product), improper service, use of an accessory or part not manufactured or sold by us, jet pump impellers and liners, operation with fuels, oils, or lubricants which are not suitable for use with the product (see **Fuel and Oil**), alteration or removal of parts, or water entering the engine through the fuel intake, air intake or exhaust system. Use of the product for racing or other competitive activity, or operating with a racing type lower unit, at any point, even by a prior owner of the product, voids the warranty.

## WARRANTY INFORMATION

Expenses related to haul-out, launch, towing, storage, telephone, rental, inconvenience, slip fees, insurance coverage, loan payments, loss of time, loss of income, or any other type of incidental or consequential damages are not covered by this warranty. Also, expenses associated with the removal and/or replacement of boat partitions or material caused by boat design for access to the product are not covered by this warranty.

Nonwarranty maintenance, replacement, or repair of emission control devices and systems may be performed by any marine engine repair establishment or individual. The use of non-Mercury parts for nonwarranty maintenance or repairs will not be grounds for disallowing other warranty work. The use of add-on (as defined at section 1900 (b)(1) and (b)(10) of Title 13 of the California Code of Regulations) or modified parts not exempted by the California Air Resources Board may be grounds for disallowing a warranty claim, at the discretion of Mercury Marine. Failures of warranted parts caused by the use of a nonexempted add-on or modified part will not be covered.

### **DISCLAIMERS AND LIMITATIONS**

**THE IMPLIED WARRANTIES OF MERCHANTABILITY AND FITNESS FOR A PARTICULAR PURPOSE ARE EXPRESSLY DISCLAIMED. TO THE EXTENT THAT THEY CANNOT BE DISCLAIMED, THE IMPLIED WARRANTIES ARE LIMITED IN DURATION TO THE LIFE OF THE EXPRESS WARRANTY. INCIDENTAL AND CONSEQUENTIAL DAMAGES ARE EXCLUDED FROM COVERAGE UNDER THIS WARRANTY. SOME STATES/COUNTRIES DO NOT ALLOW FOR THE DISCLAIMERS, LIMITATIONS AND EXCLUSIONS IDENTIFIED ABOVE, AS A RESULT, THEY MAY NOT APPLY TO YOU. THIS WARRANTY GIVES YOU SPECIFIC LEGAL RIGHTS, AND YOU MAY ALSO HAVE OTHER LEGAL RIGHTS WHICH VARY FROM STATE TO STATE AND COUNTRY TO COUNTRY.**

If you have any questions regarding your warranty rights and responsibilities, you should contact Mercury Marine at 1-920-929-5040.

# WARRANTY INFORMATION

## California Air Resources Board Explanation of Your California Emission Control Warranty Statement

**YOUR WARRANTY RIGHTS AND OBLIGATIONS:** The California Air Resources Board is pleased to explain the emission control system warranty on your 2001 model year and later outboard engine. In California, new outboard engines must be designed, built, and equipped to meet the State's stringent anti-smog standards. Mercury Marine must warrant the emission control system on your outboard engine for the periods of time listed below, provided there has been no abuse, neglect, or improper maintenance of your outboard engine.

Your emission control system may include parts such as the carburetor or fuel injection system, the ignition system, and catalytic converter. Also included may be hoses, belts, connectors, and other emission-related assemblies.

Where a warrantable condition exists, Mercury Marine will repair your outboard engine at no cost to you, including diagnosis, parts, and labor.

**MANUFACTURER'S WARRANTY COVERAGE:** Select emission control parts from model year 2001 and later outboard engines are warranted for four (4) years, or for 250 hours of use, whichever occurs first. However, warranty coverage based on the hourly period is only permitted for outboard engines and personal watercraft equipped with appropriate hour meters or their equivalent. If any emission-related part on your engine is defective under warranty, the part will be repaired or replaced by Mercury Marine.

**OWNER'S WARRANTY RESPONSIBILITIES:** As the outboard engine owner, you are responsible for the performance of the required maintenance listed in the **Maintenance** section. Mercury Marine recommends that you retain all receipts covering maintenance on your outboard engine, but Mercury Marine cannot deny warranty solely for the lack of receipts or your failure to ensure the performance of all scheduled maintenance.

# WARRANTY INFORMATION

As the outboard engine owner, you should, however, be aware that Mercury Marine may deny you warranty coverage if your outboard engine or a part has failed due to abuse, neglect, improper maintenance, or unapproved modifications.

You are responsible for presenting your outboard to a Mercury dealer authorized to service the product as soon as a problem exists. The warranty repairs will be completed in a reasonable amount of time, not to exceed 30 days.

If you have any questions regarding your warranty rights and responsibilities, you should contact Mercury Marine at 1-920-929-5040.

## Emission Certification Star Label



Outboards are labeled on the cowl with one of the following star labels.

**The symbol for a cleaner marine engine means:**

**Cleaner air and water** - for a healthier lifestyle and environment.

**Better fuel economy** - burns up to 30–40 percent less gas and oil than conventional carbureted two-stroke engines, saving money and resources.

**Longer emission warranty** - protects consumer for worry-free operation.

 <p>The label features a five-pointed star with a hand holding a banner that says "EMISSION". The word "LOW" is at the top, and "CALIFORNIA EMISSION STANDARDS" is written in a curve above the star. The number "22531" is at the bottom right.</p>	<p><b>One Star - Low Emission</b></p> <p>The One Star label identifies engines that meet the Air Resources Board's 2001 exhaust emissions standards. Engines meeting these standards have 75% lower emissions than conventional carbureted two-stroke engines. These engines are equivalent to the U.S. EPA's 2006 standards for marine engines.</p>
 <p>The label features a five-pointed star with a hand holding a banner that says "EMISSION". The words "VERY LOW" are at the top, and "FOR" is written in a curve above the star. The number "42537" is at the bottom right.</p>	<p><b>Two Stars - Very Low Emission</b></p> <p>The Two Star label identifies engines that meet the Air Resources Board's Personal Watercraft and Outboard marine engine 2004 exhaust emissions standards. Engines meeting these standards have 20% lower emissions than One Star - Low Emission engines.</p>

# WARRANTY INFORMATION



42538

## Three Stars - Ultra Low Emission

The Three Star label identifies engines that meet the Air Resources Board's Personal Watercraft and Outboard marine engine 2008 exhaust emissions standards or the Sterndrive and Inboard marine engine 2003-2008 exhaust emission standards. Engines meeting these standards have 65% lower emissions than One Star - Low Emission engines.



42539

## Four Stars - Super Ultra Low Emission

The Four Star label identifies engines that meet the Air Resources Board's Sterndrive and Inboard marine engine 2009 exhaust emission standards. Personal Watercraft and Outboard marine engines may also comply with these standards. Engines meeting these standards have 90% lower emissions than One Star - Low Emission engines.

# GENERAL INFORMATION

## Boater's Responsibilities

The operator (driver) is responsible for the correct and safe operation of the boat and safety of its occupants and general public. It is strongly recommended that each operator (driver) read and understand this entire manual before operating the outboard.

Be sure at least one additional person onboard is instructed in the basics of starting and operating the outboard and boat handling in case the driver is unable to operate the boat.

## Before Operating Your Outboard

Read this manual carefully. Learn how to operate your outboard properly. If you have any questions, contact your dealer.

Safety and operating information that is practiced, along with using good common sense, can help prevent personal injury and product damage.

This manual as well as safety labels posted on the outboard use the following safety alerts to draw your attention to special safety instructions that should be followed.

### **DANGER**

Indicates a hazardous situation which, if not avoided, will result in death or serious injury.

### **WARNING**

Indicates a hazardous situation which, if not avoided, could result in death or serious injury.

### **CAUTION**

Indicates a hazardous situation which, if not avoided, could result in minor or moderate injury.

### **NOTICE**

Indicates a situation which, if not avoided, could result in engine or major component failure.

# GENERAL INFORMATION

## Boat Horsepower Capacity

### WARNING

Exceeding the boat's maximum horsepower rating can cause serious injury or death. Overpowering the boat can affect boat control and flotation characteristics or break the transom. Do not install an engine that exceeds the boat's maximum power rating.

Do not overpower or overload your boat. Most boats will carry a required capacity plate indicating the maximum acceptable power and load as determined by the manufacturer following certain federal guidelines. If in doubt, contact your dealer or the boat manufacturer.

U.S. COAST GUARD CAPACITY	
MAXIMUM HORSEPOWER	XXX
MAXIMUM PERSON CAPACITY (POUNDS)	XXX
MAXIMUM WEIGHT CAPACITY	XXX

26777

## High-Speed and High-Performance Boat Operation

If your outboard is to be used on a high-speed or high-performance boat with which you are unfamiliar, we recommend that you never operate it at its high speed capability without first requesting an initial orientation and familiarization demonstration ride with your dealer or an operator experienced with your boat/outboard combination. For additional information, obtain a copy of our **Hi-Performance Boat Operation** booklet from your dealer, distributor, or Mercury Marine.

## Outboard Remote Control Models

The remote control connected to your outboard must be equipped with a start in neutral only protection device. This prevents the engine from starting when the shift is actuated in any position other than neutral.



# GENERAL INFORMATION

## ⚠ WARNING

Starting the engine with the drive in gear can cause serious injury or death. Never operate a boat that does not have a neutral-safety-protection device.

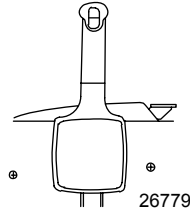

## Remote Steering Notice

The steering link rod that connects the steering cable to the engine must be fastened utilizing self-locking nuts. These self-locking nuts must never be replaced with common nuts (non-locking) as they will work loose and vibrate off, freeing the link rod to disengage.

## ⚠ WARNING

Improper fasteners or improper installation procedures can result in loosening or disengagement of the steering link rod. This can cause a sudden, unexpected loss of boat control, resulting in serious injury or death due to occupants being thrown within or out of the boat. Always use required components and follow instructions and torque procedures.

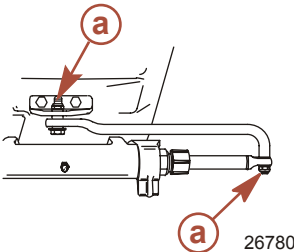

**a** - Self-locking nuts

# GENERAL INFORMATION

## Lanyard Stop Switch

The purpose of a lanyard stop switch is to turn off the engine when the operator moves far enough away from the operator's position (as in accidental ejection from the operator's position) to activate the switch. Tiller handle outboards and some remote control units are equipped with a lanyard stop switch. A lanyard stop switch can be installed as an accessory - generally on the dashboard or side adjacent to the operator's position.

The lanyard is a cord usually 122–152 cm (4–5 feet) in length when stretched out, with an element on one end made to be inserted into the switch and a snap on the other end for attaching to the operator. The lanyard is coiled to make its at-rest condition as short as possible to minimize the likelihood of lanyard entanglement with nearby objects. Its stretched-out length is made to minimize the likelihood of accidental activation should the operator choose to move around in an area close to the normal operator's position. If it is desired to have a shorter lanyard, wrap the lanyard around the operator's wrist or leg, or tie a knot in the lanyard.

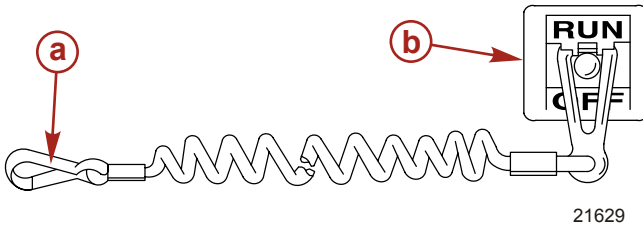

- a** - Lanyard cord
- b** - Lanyard stop switch

Read the following Safety Information before proceeding.

## GENERAL INFORMATION

**Important Safety Information:** The purpose of a lanyard stop switch is to stop the engine when the operator moves far enough away from the operator's position to activate the switch. This would occur if the operator accidentally falls overboard or moves within the boat a sufficient distance from the operator's position. Falling overboard and accidental ejections are more likely to occur in certain types of boats such as low sided inflatables, bass boats, high performance boats, and light, sensitive handling fishing boats operated by a hand tiller. Falling overboard and accidental ejections are also likely to occur as a result of poor operating practices such as sitting on the back of the seat or gunwale at planing speeds, standing at planing speeds, sitting on elevated fishing boat decks, operating at planing speeds in shallow or obstacle infested waters, releasing your grip on a steering wheel or tiller handle that is pulling in one direction, drinking alcohol or consuming drugs, or daring high speed boat maneuvers.

While activation of the lanyard stop switch will stop the engine immediately, a boat will continue to coast for some distance depending upon the velocity and degree of any turn at shut down. However, the boat will not complete a full circle. While the boat is coasting, it can cause injury to anyone in the boat's path as seriously as the boat would when under power.

We strongly recommend that other occupants be instructed on proper starting and operating procedures should they be required to operate the engine in an emergency (e.g. if the operator is accidentally ejected).

### **WARNING**

**If the operator falls out of the boat, stop the engine immediately to reduce the possibility of serious injury or death from being struck by the boat. Always properly connect the operator to the stop switch using a lanyard.**

## GENERAL INFORMATION

### WARNING

**Avoid serious injury or death from deceleration forces resulting from accidental or unintended stop switch activation. The boat operator should never leave the operator's station without first disconnecting the stop switch lanyard from the operator.**

Accidental or unintended activation of the switch during normal operation is also a possibility. This could cause any, or all, of the following potentially hazardous situations:

- Occupants could be thrown forward due to unexpected loss of forward motion - a particular concern for passengers in the front of the boat who could be ejected over the bow and possibly struck by the gearcase or propeller.
- Loss of power and directional control in heavy seas, strong current, or high winds.
- Loss of control when docking.

### **KEEP THE LANYARD STOP SWITCH AND LANYARD CORD IN GOOD OPERATING CONDITION**

Before each use, check to ensure the lanyard stop switch works properly. Start the engine and stop it by pulling the lanyard cord. If the engine does not stop, have the switch repaired before operating the boat.

Before each use, visually inspect the lanyard cord to ensure it is in good working condition and that there are no breaks, cuts, or wear to the cord. Check that the clips on the ends of the cord are in good condition. Replace any damaged or worn lanyard cords.

# GENERAL INFORMATION

## Protecting People in the Water

### WHILE YOU ARE CRUISING

It is very difficult for a person standing or floating in the water to take quick action to avoid a boat heading in his/her direction, even at slow speed.



Always slow down and exercise extreme caution any time you are boating in an area where there might be people in the water.

Whenever a boat is moving (coasting) and the outboard gear shift is in neutral position, there is sufficient force by the water on the propeller to cause the propeller to rotate. This neutral propeller rotation can cause serious injury.

### WHILE BOAT IS STATIONARY

#### WARNING

**A spinning propeller, a moving boat, or any solid device attached to the boat can cause serious injury or death to swimmers. Stop the engine immediately whenever anyone in the water is near your boat.**

Shift outboard into neutral and shut off the engine before allowing people to swim or be in the water near your boat.

# GENERAL INFORMATION

## Passenger Safety Message - Pontoon Boats and Deck Boats

Whenever the boat is in motion, observe the location of all passengers. Do not allow any passengers to stand or use seats other than those designated for traveling faster than idle speed. A sudden reduction in boat speed, such as plunging into a large wave or wake, a sudden throttle reduction, or a sharp change of boat direction, could throw them over the front of the boat. Falling over the front of the boat between the two pontoons will position them to be run over by the outboard.

### BOATS HAVING AN OPEN FRONT DECK

No one should ever be on the deck in front of the fence while the boat is in motion. Keep all passengers behind the front fence or enclosure.

Persons on the front deck could easily be thrown overboard or persons dangling their feet over the front edge could get their legs caught by a wave and pulled into the water.

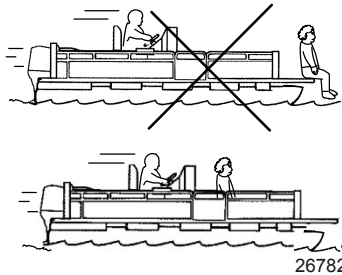

### WARNING

**Sitting or standing in an area of the boat not designed for passengers at speeds above idle can cause serious injury or death. Stay back from the front end of deck boats or raised platforms and remain seated while the boat is in motion.**

# GENERAL INFORMATION

## BOATS WITH FRONT MOUNTED, RAISED PEDESTAL FISHING SEATS

Elevated fishing seats are not intended for use when the boat is traveling faster than idle or trolling speed. Sit only in seats designated for traveling at faster speeds.

Any unexpected, sudden reduction in boat speed could result in the elevated passenger falling over the front of the boat.

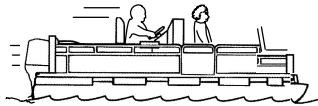
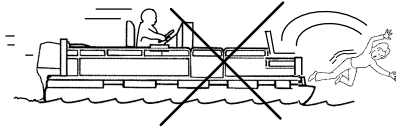

26783

## Wave and Wake Jumping

Operating recreational boats over waves and wake is a natural part of boating. However, when this activity is done with sufficient speed to force the boat hull partially or completely out of the water, certain hazards arise, particularly when the boat reenters the water.

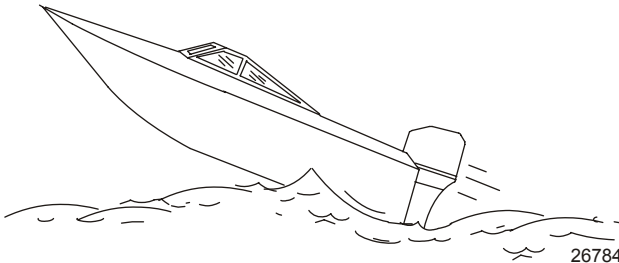

26784

The primary concern is the boat changing direction while in the midst of the jump. In such case, the landing may cause the boat to veer violently in a new direction. Such a sharp change in direction can cause occupants to be thrown out of their seats, or out of the boat.

## GENERAL INFORMATION

### WARNING

**Wave or wake jumping can cause serious injury or death from occupants being thrown within or out of the boat. Avoid wave or wake jumping whenever possible.**

There is another less common hazardous result from allowing your boat to launch off a wave or wake. If the bow of your boat pitches down far enough while airborne, upon water contact it may penetrate under the water surface and submarine for an instant. This will bring the boat to a nearly instantaneous stop and can send the occupants flying forward. The boat may also steer sharply to one side.

### Impact with Underwater Hazards

Reduce speed and proceed with caution whenever you drive a boat in shallow water areas, or in areas where you suspect underwater obstacles may exist which could be struck by the outboard or the boat bottom. **The most important thing you can do to help reduce injury or impact damage from striking a floating or underwater object is to control the boat speed. Under these conditions, boat speed should be kept to a minimum planing speed of 24 to 40 km/h (15 to 25 MPH).**

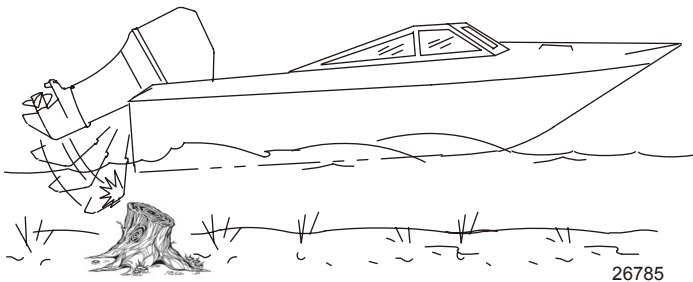

Striking a floating or underwater object could result in an infinite number of situations. Some of these situations could result in the following:

- Part of the outboard or the entire outboard could break loose and fly into the boat.



## GENERAL INFORMATION

- The boat could move suddenly in a new direction. Such a sharp change in direction can cause occupants to be thrown out of their seats or out of the boat.
- A rapid reduction in speed. This will cause occupants to be thrown forward, or even out of the boat.
- Impact damage to the outboard and/or boat.

Keep in mind, the most important thing you can do to help reduce injury or impact damage during an impact is control the boat speed. Boat speed should be kept to a minimum planing speed when driving in waters known to have underwater obstacles.

After striking a submerged object, stop the engine as soon as possible and inspect it for any broken or loose parts. If damage is present or suspected, the outboard should be taken to an authorized dealer for a thorough inspection and necessary repair.

The boat should also be checked for any hull fractures, transom fractures, or water leaks.

Operating a damaged outboard could cause additional damage to other parts of the outboard, or could affect control of the boat. If continued running is necessary, do so at greatly reduced speeds.

### **WARNING**

**Operating a boat or engine with impact damage can result in product damage, serious injury, or death. If the vessel experiences any form of impact, have an authorized Mercury Marine dealer inspect and repair the vessel or power package.**

## Safety Instructions for Hand-Tilled Outboards

No person or cargo should occupy the area directly in front of the outboard while the boat is in motion. If an underwater obstacle is struck, the outboard will tilt up and could seriously injure anyone occupying this area.

# GENERAL INFORMATION

## MODELS WITH CLAMP SCREWS:

Some outboards come with transom bracket clamp screws. The use of clamp bracket screws alone, is insufficient to properly and safely secure the outboard to the transom. Proper installation of the outboard includes bolting the engine to the boat through the transom. Refer to **Installation - Installing Outboard** for more complete installation information.

### **WARNING**

**Failure to correctly fasten the outboard could result in the outboard propelling off the boat transom resulting in property damage, serious injury, or death. Before operation, the outboard must be correctly installed with the required mounting hardware. Do not accelerate above idle speed in water that may contain underwater obstacles if the outboard is not attached to the transom correctly.**

If an obstacle is struck at planing speed and the outboard is not securely fastened to the transom, it is possible the outboard could lift off the transom and land in the boat.

## Exhaust Emissions

### BE ALERT TO CARBON MONOXIDE POISONING

Carbon monoxide (CO) is a deadly gas that is present in the exhaust fumes of all internal combustion engines, including the engines that propel boats, and the generators that power boat accessories. By itself, CO is odorless, colorless, and tasteless, but if you can smell or taste engine exhaust, you are inhaling CO.

Early symptoms of carbon monoxide poisoning, which are similar to the symptoms of seasickness and intoxication, include headache, dizziness, drowsiness, and nausea.

# GENERAL INFORMATION

## WARNING

Inhaling engine exhaust gases can result in carbon monoxide poisoning, which can lead to unconsciousness, brain damage, or death. Avoid exposure to carbon monoxide.

Stay clear from exhaust areas when engine is running. Keep the boat well-ventilated while at rest or underway.

### STAY CLEAR OF EXHAUST AREAS

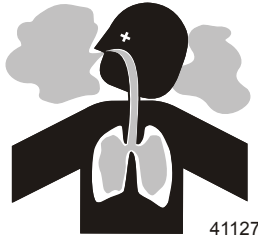

Engine exhaust gases contain harmful carbon monoxide. Avoid areas of concentrated engine exhaust gases. When engines are running, keep swimmers away from the boat, and do not sit, lie, or stand on swim platforms or boarding ladders. While underway, do not allow passengers to be positioned immediately behind the boat (platform dragging, teak/body surfing). This dangerous practice not only places a person in an area of high engine exhaust concentration, but also subjects them to the possibility of injury from the boat propeller.

### GOOD VENTILATION

Ventilate the passenger area, open side curtains or forward hatches to remove fumes.

Example of desired air flow through the boat:

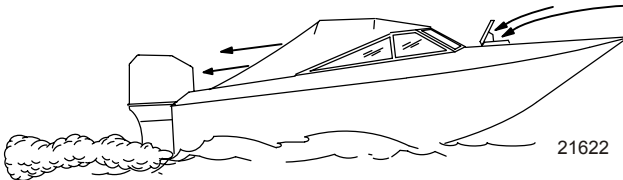

# GENERAL INFORMATION

## POOR VENTILATION

Under certain running and/or wind conditions, permanently enclosed or canvas enclosed cabins or cockpits with insufficient ventilation may draw in carbon monoxide. Install one or more carbon monoxide detectors in your boat.

Although the occurrence is rare, on a very calm day, swimmers and passengers in an open area of a stationary boat that contains, or is near, a running engine may be exposed to a hazardous level of carbon monoxide.

### 1. Examples of poor ventilation while the boat is stationary:

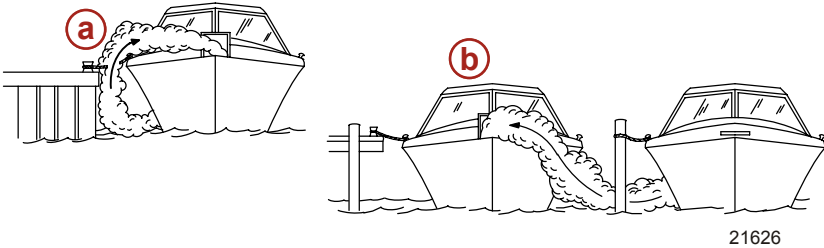

- a** - Operating the engine when the boat is moored in a confined space
- b** - Mooring close to another boat that has its engine operating

### 2. Examples of poor ventilation while the boat is moving:



- a** - Operating the boat with the trim angle of the bow too high
- b** - Operating the boat with no forward hatches open (station wagon effect)

# GENERAL INFORMATION

## Selecting Accessories for Your Outboard

Genuine Mercury Precision or Quicksilver Accessories have been specifically designed and tested for your outboard. These accessories are available from Mercury Marine dealers.

**IMPORTANT: Check with your dealer before installing accessories. The misuse of approved accessories or the use of nonapproved accessories can damage the product.**

Some accessories not manufactured or sold by Mercury Marine are not designed to be safely used with your outboard or outboard operating system. Acquire and read the installation, operation and maintenance manuals for all your selected accessories.

## Safe Boating Suggestions

In order to safely enjoy the waterways, familiarize yourself with local and other governmental boating regulations and restrictions, and consider the following suggestions.

**Use flotation devices.** Have an approved personal flotation device of suitable size for each person aboard (it is the law) and have it readily accessible.

**Do not overload your boat.** Most boats are rated and certified for maximum load (weight) capacities (refer to your boat capacity plate). If in doubt, contact your dealer or the boat's manufacturer.

**Perform safety checks and required maintenance.** Follow a regular schedule and ensure that all repairs are properly made.

**Know and obey all nautical rules and laws of the waterways.** Boat operators should complete a boating safety course. Courses are offered in the U.S.A. by 1) the U.S. Coast Guard Auxiliary, 2) the Power Squadron, 3) the Red Cross, and 4) your state boating law enforcement agency. Inquiries may be made to the Boating Hotline, 1-800-368-5647 or the Boat U.S. Foundation information number 1-800-336-BOAT.

## GENERAL INFORMATION

**Make sure everyone in the boat is properly seated.** Do not allow anyone to sit or ride on any part of the boat that was not intended for such use. This includes the back of seats, gunwales, transom, bow, decks, raised fishing seats, any rotating fishing seat; or anywhere that an unexpected acceleration, sudden stopping, unexpected loss of boat control, or sudden boat movement could cause a person to be thrown overboard or into the boat.

**Never be under the influence of alcohol or drugs while boating (it is the law).** Alcohol or drug use impairs your judgment and greatly reduces your ability to react quickly.

**Prepare other boat operators.** Instruct at least one other person onboard in the basics of starting and operating the outboard, and boat handling, in case the driver becomes disabled or falls overboard.

**Passenger boarding.** Stop the engine whenever passengers are boarding, unloading, or are near the back (stern) of the boat. Just shifting the outboard into neutral is not sufficient.

**Be alert.** The operator of the boat is responsible by law to maintain a proper lookout by sight and hearing. The operator must have an unobstructed view particularly to the front. No passengers, load, or fishing seats should block the operator's view when operating the boat above idle speed.

**Never drive your boat directly behind a water-skier in case the skier falls.** As an example, your boat traveling at 40 km/h (25 MPH) will overtake a fallen skier 61 m (200 ft) in front of you in 5 seconds.

**Watch fallen skiers.** When using your boat for waterskiing or similar activities, always keep a fallen or down skier on the operator's side of the boat while returning to assist the skier. The operator should always have the down skier in sight and never back up to the skier or anyone in the water.

# GENERAL INFORMATION

**Report accidents.** Boat operators are required by law to file a Boating Accident Report with their state boating law enforcement agency when their boat is involved in certain boating accidents. A boating accident must be reported if 1) there is loss of life or probable loss of life, 2) there is personal injury requiring medical treatment beyond first aid, 3) there is damage to boats or other property where the damage value exceeds \$500.00, or 4) there is complete loss of the boat. Seek further assistance from local law enforcement.

## Recording Serial Number

It is important to record this number for future reference. The serial number is located on the outboard as shown.

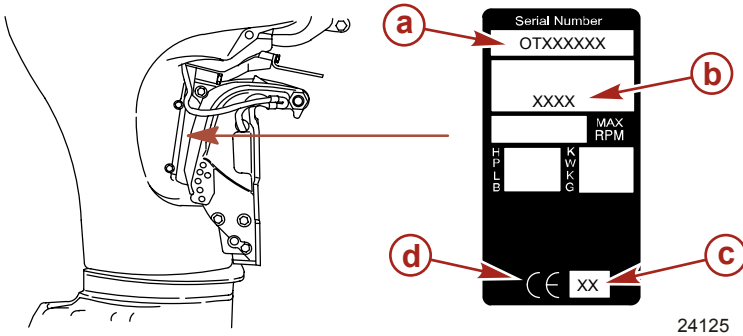

- a** - Serial number
- b** - Model designation
- c** - Year manufactured
- d** - Certified Europe Insignia (as applicable)

## 40/50/60 FourStroke Specifications

Models	40	50	60
Horsepower	40	50	60
Kilowatts	29.4	36.8	44.1
Full throttle RPM range	5500–6000 RPM		
Number of cylinders	4		
Idle speed in forward gear	Controlled by ECM		

# GENERAL INFORMATION

Models	40	50	60
Piston displacement	995 cc (60.8 in <sup>3</sup> )		
Cylinder bore	65 mm (2.559 in.)		
Stroke	75 mm (2.953 in.)		
Valve clearance (cold)			
Intake valve	0.15–0.25 mm (0.006–0.010 in.)		
Exhaust valve	0.25–0.35 mm (0.010–0.014 in.)		
Recommended spark plug	Champion RA8HC		
Spark plug gap	1.0 mm (0.040 in.)		
Gear ratio			
83 mm (3-1/4 in.) diameter gearcase	1.83:1		
108 mm (4-1/4 in.) diameter gearcase	2.31:1		
Recommended gasoline	Refer to <b>Fuel and Oil</b>		
Recommended oil	Refer to <b>Fuel and Oil</b>		
Gearcase lubricant capacity			
83 mm (3-1/4 in.) diameter gearcase	340 ml (11.5 fl oz)		
108 mm (4-1/4 in.) diameter gearcase	710 ml (24.0 fl oz)		
Engine oil capacity	3.0 liter (3 US qt)		
Battery rating			
Operation above 0 °C (32 °F)	465 marine cranking amps (MCA) or 350 cold cranking amps (CCA)		
Operation below 0 °C (32 °F)	1000 marine cranking amps (MCA) or 750 cold cranking amps (CCA)		
Ampere hours (Ah)	70–100		
Emission control system	Electronic engine control (EC)		
Sound at drivers ear (ICOMIA 39-94) dBA	81.1		
Tiller handle vibration (ICOMIA 38-94) m/s <sup>2</sup>	3.3		



# GENERAL INFORMATION

## Component Identification

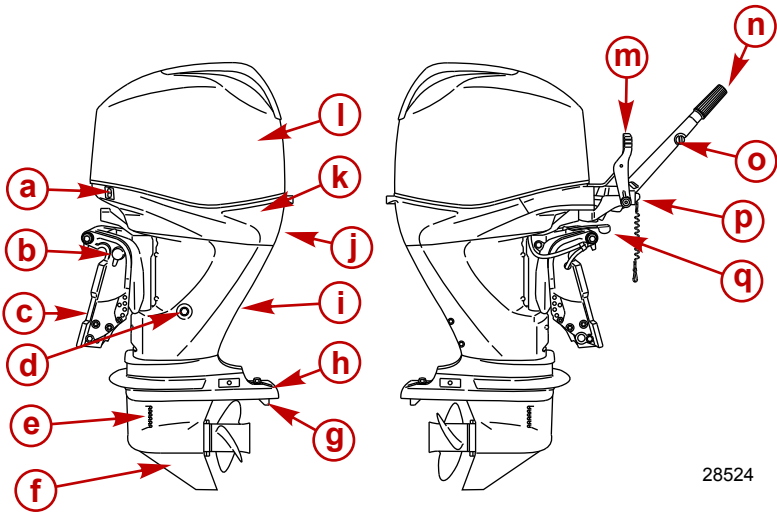

28524

- a** - Auxiliary tilt switch
- b** - Tilt support knob
- c** - Transom brackets
- d** - Oil drain plug
- e** - Primary cooling water intake
- f** - Gearcase
- g** - Trim tab
- h** - Anti-ventilation plate
- i** - Driveshaft housing
- j** - Water pump indicator hole
- k** - Bottom cowl
- l** - Top cowl
- m** - Shift handle
- n** - Engine stop switch
- o** - Throttle friction adjustment knob
- p** - Lanyard stop switch
- q** - Steering friction adjustment lever (tiller handle models)

# TRANSPORTING

## Trailing Boat/Outboard

Trailer your boat with the outboard tilted down in a vertical operating position.

If additional ground clearance is required, the outboard should be tilted up using an accessory outboard support device. Refer to your local dealer for recommendations. Additional clearance may be required for railroad crossings, driveways, and trailer bouncing.

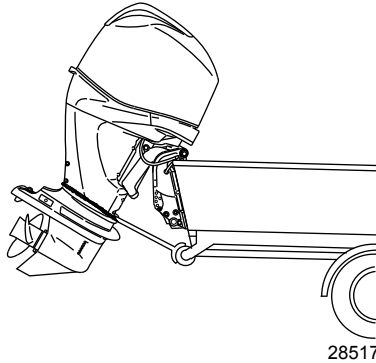

28517

**IMPORTANT:** Do not rely on the power trim/tilt system or tilt support lever to maintain proper ground clearance for trailering. The outboard tilt support lever is not intended to support the outboard for trailering.

# TRANSPORTING

## Transporting Portable Fuel Tanks

### WARNING

Avoid serious injury or death from a gasoline fire or explosion. Follow the transporting instructions supplied with the portable fuel tank. Transport the fuel tank in a well ventilated area away from open flame or sparks.

### MANUAL VENTING TYPE FUEL TANK

Close fuel tank air vent when transporting tank. This will prevent escape of fuel or vapors from tank.

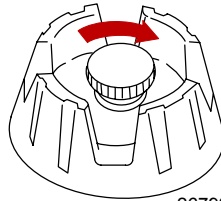

26793

### AUTO-VENTING TYPE FUEL TANK

1. Disconnect the remote fuel line from tank. This will close the air vent and prevent escape of fuel or vapors from tank.
2. Install tether cap over the fuel line connector stem. This will protect the connector stem from being accidentally pushed-in, allowing fuel or vapor to escape.

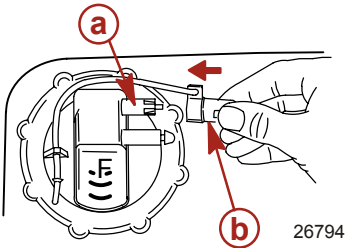

**a** - Connector stem

**b** - Tether cap

26794

# FUEL & OIL

## Fuel Recommendations

**IMPORTANT:** Use of improper gasoline can damage your engine. Engine damage resulting from the use of improper gasoline is considered misuse of the engine, and damage caused thereby will not be covered under the limited warranty.

### FUEL RATINGS

Mercury Marine engines will operate satisfactorily when using a major brand of unleaded gasoline meeting the following specifications:

**USA and Canada** - having a posted pump Octane Rating of 87 (R+M)/2 minimum. Premium gasoline (92 [R+M]/2 Octane) is also acceptable. Do not use leaded gasoline.

**Outside USA and Canada** - having a posted pump Octane Rating of 90 RON minimum. Premium gasoline (98 RON) is also acceptable. If unleaded gasoline is not available, use a major brand of leaded gasoline.

### USING REFORMULATED (OXYGENATED) GASOLINES (USA ONLY)

This type of gasoline is required in certain areas of the USA. The 2 types of oxygenates used in these fuels are alcohol (ethanol) or ether (MTBE or ETBE). If ethanol is the oxygenate that is used in the gasoline in your area, refer to **Gasolines Containing Alcohol**.

These reformulated gasolines are acceptable for use in your Mercury Marine engine.

### GASOLINES CONTAINING ALCOHOL

If the gasoline in your area contains either methanol (methyl alcohol) or ethanol (ethyl alcohol), you should be aware of certain adverse effects that can occur. These adverse effects are more severe with methanol. Increasing the percentage of alcohol in the fuel can also worsen these adverse effects.

Some of these adverse effects are caused because the alcohol in the gasoline can absorb moisture from the air, resulting in a separation of the water/alcohol from the gasoline in the fuel tank.

## FUEL & OIL

The fuel system components on your Mercury Marine engine will withstand up to 10% alcohol content in the gasoline. We do not know what percentage your boat's fuel system will withstand. Contact your boat manufacturer for specific recommendations on the boat's fuel system components (fuel tanks, fuel lines, and fittings). Be aware that gasolines containing alcohol may cause increased:

- Corrosion of metal parts
- Deterioration of rubber or plastic parts
- Fuel permeation through rubber fuel lines
- Starting and operating difficulties

### WARNING

**Fuel leakage is a fire or explosion hazard, which can cause serious injury or death. Periodically inspect all fuel system components for leaks, softening, hardening, swelling, or corrosion, particularly after storage. Any sign of leakage or deterioration requires replacement before further engine operation.**

Because of possible adverse effects of alcohol in gasoline, it is recommended that only alcohol-free gasoline be used where possible. If only fuel containing alcohol is available, or if the presence of alcohol is unknown, increased inspection frequency for leaks and abnormalities is required.

**IMPORTANT:** When operating a Mercury Marine engine on gasoline containing alcohol, storage of gasoline in the fuel tank for long periods should be avoided. Long periods of storage, common to boats, create unique problems. In cars, alcohol-blend fuels normally are consumed before they can absorb enough moisture to cause trouble, but boats often sit idle long enough for phase separation to take place. In addition, internal corrosion may take place during storage if alcohol has washed protective oil films from internal components.

# FUEL & OIL

## Low Permeation Fuel Hose Requirement

Required for outboards manufactured for sale, sold, or offered for sale in the United States.

- The Environmental Protection Agency (EPA) requires that any outboard manufactured after January 1, 2009 must use low permeation fuel hose for the primary fuel hose connecting the fuel tank to the outboard.
- Low permeation hose is USCG Type B1-15 or Type A1-15, defined as not exceeding  $15/\text{gm}^2/24 \text{ h}$  with CE 10 fuel at  $23 \text{ }^\circ\text{C}$  as specified in SAE J 1527 - marine fuel hose.

## Filling Fuel Tank

### WARNING

**Avoid serious injury or death from a gasoline fire or explosion. Use caution when filling fuel tanks. Always stop the engine and do not smoke or allow open flames or sparks in the area while filling fuel tanks.**

Fill fuel tanks outdoors away from heat, sparks, and open flames. Remove portable fuel tanks from boat to refill them.

Always stop engine before refilling tanks.

Do not completely fill the fuel tanks. Leave approximately 10% of the tank volume unfilled. Fuel will expand in volume as its temperature rises and can leak under pressure if the tank is completely filled.

## PORTABLE FUEL TANK PLACEMENT IN THE BOAT

Place the fuel tank in the boat so the vent is higher than the fuel level under normal boat operating conditions.

# FUEL & OIL

## Engine Oil Recommendations

We recommend the use of Mercury or Quicksilver NMMA FC-W certified synthetic blend 25W-40 4-Stroke Outboard Oil for general, all-temperature use. If SAE 10W-30 oil is preferred, use Mercury or Quicksilver NMMA FC-W certified 10W-30 4-Stroke Outboard Oil. If the recommended Mercury or Quicksilver NMMA FC-W certified outboard oils are not available, a major brand of NMMA FC-W certified 4-stroke outboard oil of similar viscosity may be used.

When operating in temperatures above 4 °C (40 °F), we encourage the use of NMMA FC-W certified synthetic blend 25W-40 4-Stroke Outboard Oil.

**IMPORTANT:** The use of nondetergent oils, multi-viscosity oils (other than Mercury or Quicksilver NMMA FC-W certified oil or a major brand NMMA FC-W certified oil), synthetic oils, low quality oils, or oils that contain solid additives are not recommended.

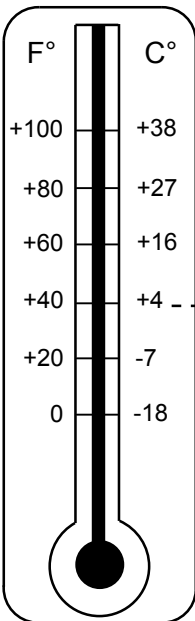

11583

### Recommended SAE viscosity for engine oil

- a** - NMMA FC- W certified 10W-30 outboard oil may be used at temperatures below 4 °C (40 °F)
- b** - NMMA FC-W certified synthetic blend 25W-40 outboard oil may be used in all temperatures

## Checking and Adding Engine Oil

**IMPORTANT:** Do not overfill. Be sure that the outboard is upright (not tilted) when checking oil.

# FUEL & OIL

1. Turn the engine off. Have the outboard in a level operating position. Remove the top cowl.
2. Flip the handle up and pull out the dipstick. Wipe it with a clean rag or towel and push it back in all the way.
3. Pull the dipstick back out again and observe the oil level. If the oil level is low, remove the oil filler cap and fill to (but not over) the upper oil level with the recommended oil.

**IMPORTANT: Inspect oil for signs of contamination. Oil contaminated with water will have a milky color to it; oil contaminated with fuel will have a strong fuel smell. If contaminated oil is noticed, have the engine checked by your dealer.**

4. Push the dipstick back in all the way, then flip the handle down to lock the dipstick in place. Reinstall the oil filler cap and hand tighten securely.

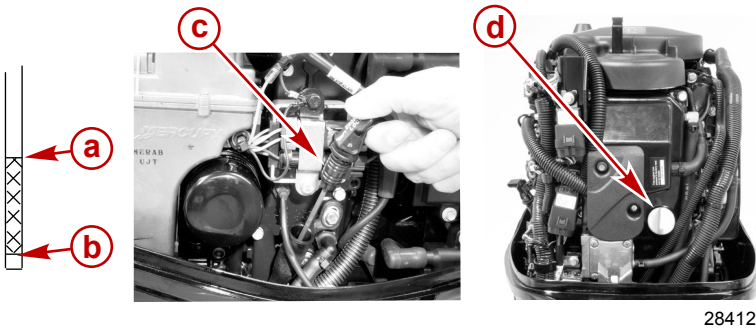

28412

- a - Full mark
- b - Add mark
- c - Dipstick
- d - Oil filler cap



# FEATURES & CONTROLS

## Remote Control Features

Your boat may be equipped with one of the Mercury Precision or Quicksilver remote controls shown. If not, consult your dealer for a description of the functions and operations of the remote control.

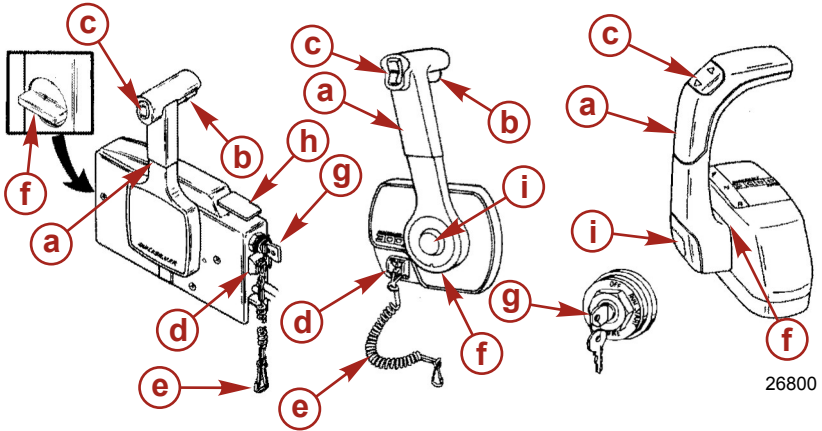

- a** - Control handle - forward, neutral, reverse
- b** - Neutral release lever
- c** - Trim/tilt switch (if equipped) - Refer to **Features and Controls - Power Trim and Tilt**
- d** - Lanyard stop switch - Refer to **General Information - Lanyard Stop Switch**
- e** - Lanyard - Refer to **General Information - Lanyard Stop Switch**
- f** - Throttle friction adjustment - Console controls require cover removal for adjustment
- g** - Ignition key switch - "OFF," "ON," "START"
- h** - Fast idle lever - Refer to **Operation - Starting the Engine**
- i** - Throttle only button - Refer to **Operation - Starting the Engine**

# FEATURES & CONTROLS

## Warning System

### WARNING HORN SIGNALS

The outboard warning system incorporates a warning horn inside the boat. Remote control models will have the warning horn located inside the remote control or connected to the ignition key switch. Tiller handle models will have the warning horn located in the ignition key panel.

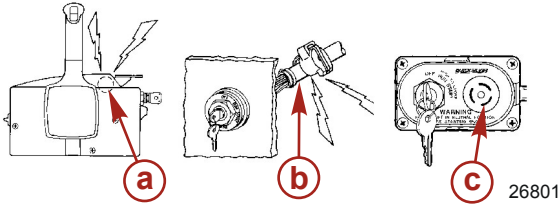

- a** - Horn inside remote control
- b** - Horn connected to ignition key switch
- c** - Horn in ignition key panel

There are two types of warning horns to alert the operator of an active problem within the engine's operating system.

1. **Continuous six second beep:** Indicates a critical engine condition. Depending on the condition, the Engine Guardian System may engage and protect the engine by limiting its power. You should return to port immediately and contact your servicing dealer.
2. **Intermittent short beeps for six seconds:** Indicates a noncritical engine condition. This condition does not require immediate attention. You may continue using your boat, however, depending on the nature of the problem, the engine's power may be limited by the Engine Guardian System (see Engine Guardian System following) to protect the engine. You should contact your servicing dealer at your earliest convenience.

## FEATURES & CONTROLS

It is important to note that in either of the above scenarios, the horn will only sound one time. If you key the engine off and restart it, the horn will sound again, one time, if the fault is still present. For visual display of the specific engine functions and additional engine data, refer to SmartCraft Product information, following.

The operator is able to correct a couple engine problems indicated by the warning horn. These conditions are as follows:

- Cooling system (water pressure or engine temperature) problem. The warning horn will sound Intermittent short beeps for six seconds. Stop the engine and check the water intake holes in the gearcase for obstruction.
- Low oil pressure problem. The warning horn will sound a continuous six second beep. Stop the engine and check for low engine oil level. Refer to **Fuel and Oil – Checking and Adding Engine Oil**.

### ENGINE GUARDIAN SYSTEM

The Engine Guardian System monitors the critical sensors on the engine for any early indications of problems. Engine Guardian is functional whenever your engine is operating, so you never have to be concerned about whether or not you are protected. The system will respond to a problem by sounding the warning horn for six seconds and/or reducing engine power in order to provide engine protection.

If the Guardian System has been activated, reduce throttle speed. The problem will need to be identified and corrected, if possible. The system must be reset before the engine will operate at higher speeds. Moving the throttle lever back to the idle position will reset the system.

### SMARTCRAFT PRODUCT

A Mercury SmartCraft System instrument package can be purchased for this outboard. A few of the functions the instrument package will display are engine RPM, coolant temperature, oil pressure, water pressure, battery voltage, fuel consumption, and engine operating hours.

# FEATURES & CONTROLS

The SmartCraft Instrument package will also aid in Engine Guardian diagnostics. The SmartCraft Instrument package will display critical engine alarm data and potential problems.

## Power Trim and Tilt

Your outboard has a trim/tilt control called power trim. This enables the operator to easily adjust the position of the outboard by pressing the trim switch. Moving the outboard in closer to the boat transom is called trimming in or down. Moving the outboard further away from the boat transom is called trimming out or up. The term trim generally refers to the adjustment of the outboard within the first 20° range of travel. This is the range used while operating your boat on plane. The term tilt is generally used when referring to adjusting the outboard further up out of the water. With the engine turned off, the outboard can be tilted out of the water. At low idle speed, the outboard can also be tilted up past the trim range to permit, for example, shallow water operation.

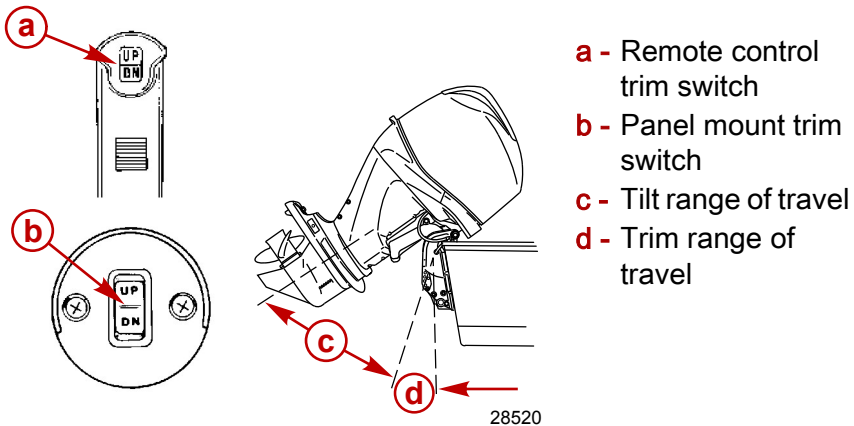

## POWER TRIM OPERATION

With most boats, operating around the middle of the trim range will give satisfactory results. However, to take full advantage of the trimming capability there may be times when you choose to trim your outboard all the way in or out. Along with an improvement in some performance aspects comes a greater responsibility for the operator, and this is being aware of some potential control hazards.

# FEATURES & CONTROLS

The most significant control hazard is a pull or torque that is felt on the steering wheel or tiller handle. This steering torque results from the outboard trimmed so that the propeller shaft is not parallel to the water surface.

## WARNING

**Trimming the outboard beyond a neutral steering condition may result in a pull on the steering wheel or tiller handle and loss of boat control. Maintain control of the boat if trimming beyond a neutral steering condition.**

Consider the following lists carefully.

Trimming in or down can:

- Lower the bow
- Result in quicker planing off, especially with a heavy load or a stern heavy boat
- Generally improve the ride in choppy water
- Increase steering torque or pull to the right (with the normal right hand rotation propeller)
- In excess, can lower the bow of some boats to a point where they begin to plow with their bow in the water while on plane. This can result in an unexpected turn in either direction (called bow steering or oversteering) if any turn is attempted, or if a significant wave is encountered.

## WARNING

**Operating the boat at high speeds with the outboard trimmed too far under can create excessive bow steer, resulting in the operator losing control of the boat. Install the trim limit pin in a position that prevents excessive trim under and operate the boat in a safe manner.**

- In rare circumstances, the owner may decide to limit the trim in. This is accomplished by repositioning the tilt stop pins into the desired adjustment holes in the transom brackets.

Trimming out or up can:

- Lift the bow higher out of the water

# FEATURES & CONTROLS

- Generally increase top speed
- Increase clearance over submerged objects or a shallow bottom
- Increase steering torque or pull to the left at a normal installation height (with the normal right hand rotation propeller)
- In excess, can cause boat porpoising (bouncing) or propeller ventilation
- Cause engine overheating if any cooling water intake holes are above the waterline

## TILTING OPERATION

To tilt outboard, shut off the engine and press the trim/tilt switch or auxiliary tilt switch to the up position. The outboard will tilt up until the switch is released or it reaches its maximum tilt position.

1. Press the knob in and rotate it to engage the tilt support lever.
2. Lower outboard to rest on the tilt support lever.
3. To disengage the tilt support lever, raise the outboard off the support lever and rotate the lever down. Lower the outboard.

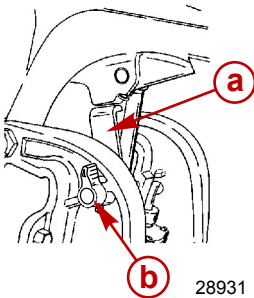

**a** - Tilt support lever

**b** - Knob

## MANUAL TILTING

If the outboard cannot be tilted using the power trim/tilt switch, the outboard can be manually tilted.

# FEATURES & CONTROLS

1. Turn out the manual tilt release valve three turns counterclockwise. This allows manual tilting of the outboard. Tilt the outboard to the desired position and tighten the manual tilt release valve.

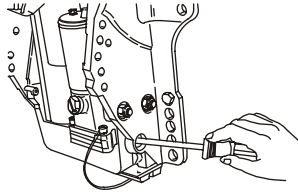

26809

**NOTE:** The manual tilt release valve must be tightened before operating the outboard to prevent the outboard from tilting up during reverse operation.

## AUXILIARY TILT SWITCH

The auxiliary tilt switch can be used to tilt the outboard up or down using the power trim system.

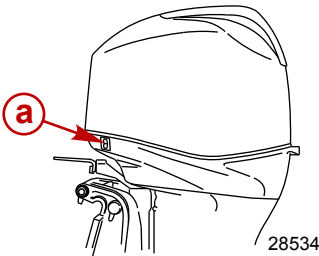

**a** - Auxiliary tilt switch

28534

## SHALLOW WATER OPERATION

When operating the boat in shallow water, the outboard can be tilted beyond the maximum trim range to prevent hitting bottom.

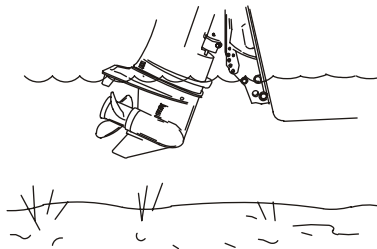

26803

# FEATURES & CONTROLS

1. Reduce engine speed below 2000 RPM.
2. Tilt outboard up, keeping the water intake holes submerged at all times.
3. Operate the engine at slow speed only. If engine speed exceeds 2000 RPM, the outboard will automatically return down to the maximum trim range.

## Throttle Grip Friction Adjustment - Tiller Handle Models

Throttle grip friction knob - Turn friction knob to set and maintain the throttle at desired speed. Turn knob clockwise to tighten friction and turn knob counterclockwise to loosen friction.

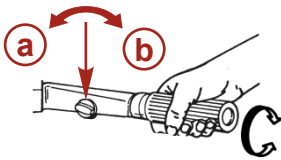

- a - Loosen friction
- b - Tighten friction

19807

## Steering Friction Adjustment - Tiller Handle Models

**NOTE:** Steering friction adjustment is only provided on models with tiller handles.

Adjust this lever to achieve the desired steering friction (drag) on the tiller handle. Move lever to the left to tighten friction or move to the right to loosen friction.

**NOTE:** To maintain proper adjustment, the locknut located on top of the steering friction lever pivot shaft can be tightened.

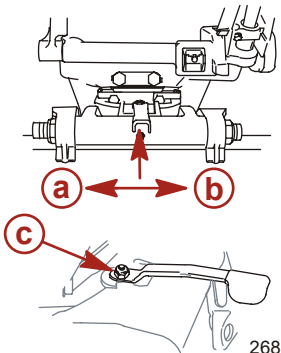

- a - Tighten friction
- b - Loosen friction
- c - Locknut

26811



# FEATURES & CONTROLS

## ⚠ WARNING

Insufficient friction adjustment can cause serious injury or death due to loss of boat control. When setting the friction adjustment, maintain sufficient steering friction to prevent the outboard from steering into a full turn if the tiller handle is released.

## Trim Tab Adjustment

Propeller steering torque will cause your boat to pull in one direction. This steering torque is a normal result from your outboard not trimmed with the propeller shaft parallel to the water surface. The trim tab can help to compensate for this steering torque in many cases and can be adjusted within limits to reduce any unequal steering effort.

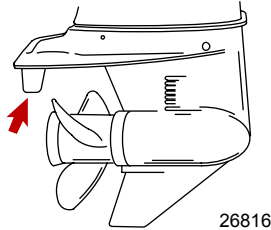

**NOTE:** Trim tab adjustment will have little effect reducing steering torque if the outboard is installed with the anti-ventilation plate approximately 50 mm (2 in.) or more above the boat bottom.

## MODELS WITHOUT POWER TRIM

Operate your boat at normal cruising speed trimmed to desired position by installing the tilt pin in the desired tilt pin hole. Turn your boat left and right and note the direction the boat turns more easily. If adjustment is necessary, loosen trim tab bolt and make small adjustments at a time. If the boat turns more easily to the left, move the trailing edge of trim tab to the left. If the boat turns more easily to the right, move the trailing edge of trim tab to the right. Retighten bolt and retest.

# FEATURES & CONTROLS

## MODELS WITH POWER TRIM

Operate your boat at normal cruising speed, trimmed to desired position. Turn your boat left and right and note the direction the boat turns more easily.

If adjustment is necessary, loosen trim tab bolt and make small adjustments at a time. If the boat turns more easily to the left, move the trailing edge of trim tab to the left. If the boat turns more easily to the right, move the trailing edge of trim tab to the right. Retighten bolt and retest.

# OPERATION

## Pre-Starting Check List

- Operator knows safe navigation, boating, and operating procedures.
- An approved personal flotation device of suitable size for each person aboard and readily accessible (it is the law).
- A ring type life buoy or buoyant cushion designed to be thrown to a person in the water.
- Know your boats' maximum load capacity. Look at the boat capacity plate.
- Fuel supply OK.
- Arrange passengers and load in the boat so the weight is distributed evenly and everyone is seated in a proper seat.
- Tell someone where you are going and when you expect to return.
- It is illegal to operate a boat while under the influence of alcohol or drugs.
- Know the waters and area you will be boating; tides, currents, sand bars, rocks, and other hazards.
- Make inspection checks listed in **Maintenance - Inspection and Maintenance Schedule**.

## Operating in Freezing Temperatures

When using your outboard or having your outboard moored in freezing or near freezing temperatures, keep the outboard tilted down at all times so the gearcase is submerged. This prevents the trapped water in the gearcase from freezing and causing possible damage to the water pump and other components.

If there is a chance of ice forming on the water, the outboard should be removed and drained completely of water. If ice should form at the water level inside the outboard driveshaft housing, it will block water flow to the engine causing possible damage.

## Operating in Saltwater or Polluted Water

We recommend that you flush the internal water passages of your outboard with fresh water after each use in salt or polluted water. This will prevent a buildup of deposits from clogging the water passages. Refer to **Maintenance - Flushing the Cooling System**.

# OPERATION

If you keep your boat moored in the water, always tilt the outboard so the gearcase is completely out of water (except in freezing temperatures) when not in use.

Wash the outboard exterior and flush out the exhaust outlet of the propeller and gearcase with fresh water after each use. Each month, spray Mercury Precision or Quicksilver Corrosion Guard on external metal surfaces. Do not spray on corrosion control anodes as this will reduce the effectiveness of the anodes.

## Pre-Starting Instructions

1. Check the engine oil level.

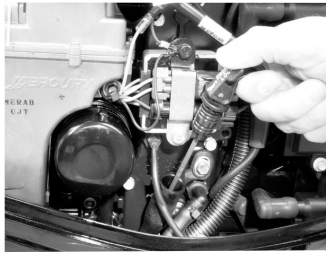

28525

2. Make sure the cooling water intake is submerged.

### *NOTICE*

Without sufficient cooling water, the engine, the water pump, and other components will overheat and suffer damage. Provide a sufficient supply of water to the water inlets during operation.

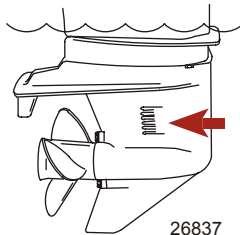

26837

# OPERATION

## Engine Break-in Procedure

**IMPORTANT:** Failure to follow the engine break-in procedures can result in poor performance throughout the life of the engine and can cause engine damage. Always follow break-in procedures.

1. For the first hour of operation, run the engine at varied throttle settings up to 3500 RPM or at approximately half throttle.
2. For the second hour of operation, run the engine at varied throttle settings up to 4500 RPM or at three-quarter throttle, and during this period of time, run it at full throttle for approximately one minute every ten minutes.
3. For the next eight hours of operation, avoid continuous operation at full throttle for more than five minutes at a time.

## Starting the Engine - Remote Control Models

Before starting, read the **Pre-Starting Check List**, special operating instructions, and **Engine Break-in Procedure** in the **Operation** section.

### *NOTICE*

Without sufficient cooling water, the engine, the water pump, and other components will overheat and suffer damage. Provide a sufficient supply of water to the water inlets during operation.

1. Open fuel tank vent screw (in filler cap) on manual venting type fuel tanks.

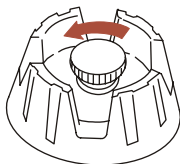

19748

# OPERATION

2. Position the fuel line primer bulb so the arrow on the side of the bulb is pointing up. Squeeze the fuel line primer bulb several times until it feels firm.

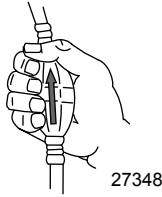

3. Set the lanyard stop switch to "RUN" position. Refer to **General Information - Lanyard Stop Switch**.

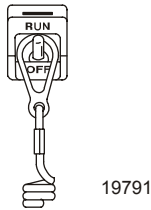

4. Shift outboard to neutral ("N") position.

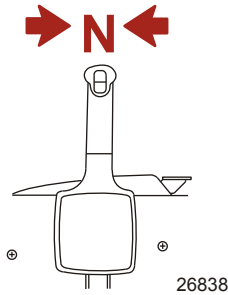

# OPERATION

5. Move the throttle-only lever to the fully closed position or press the throttle-only button.

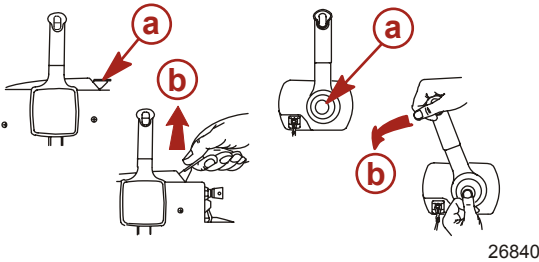

**a** - Fully closed position

**b** - Maximum fast idle speed position

6. Starting a flooded engine - Advance the throttle-only lever or control handle to the maximum throttle-only position and continue to crank the engine for starting. Immediately reduce engine speed after engine starts.
7. Turn ignition key to the "START" position. If the engine fails to start in ten seconds, return the key to the "ON" position, wait 30 seconds and try again.

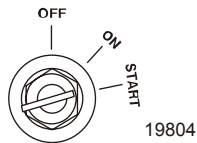

8. After engine starts, check for a steady stream of water flowing out of the water pump indicator hole.

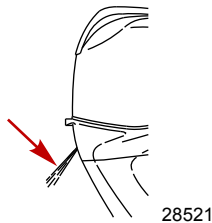

# OPERATION

**IMPORTANT:** If no water is coming out of the water pump indicator hole, stop engine and check cooling water intake for obstruction. No obstruction may indicate a water pump failure or blockage in the cooling system. These conditions will cause the engine to overheat. Have the outboard checked by your dealer. Operating the engine while overheated will cause engine damage.

## WARMING UP ENGINE

Before beginning operation, allow the engine to warm up at idling speed for three minutes.

## Starting the Engine - Tiller Handle Models

Before starting, read the **Pre-Starting Check List**, special operating instructions, and **Engine Break-in Procedure** in the **Operation** section.

### NOTICE

Without sufficient cooling water, the engine, the water pump, and other components will overheat and suffer damage. Provide a sufficient supply of water to the water inlets during operation.

1. Open fuel tank vent screw (in filler cap) on manual venting type fuel tanks.

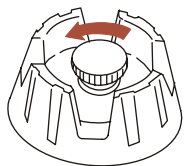

19748

2. Connect the remote fuel line to the outboard. Make sure the connector is snapped into place.

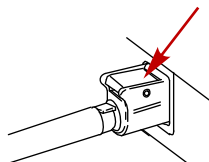

28526



# OPERATION

3. Position the fuel line primer bulb so the arrow on the side of the bulb is pointing up. Squeeze the fuel line primer bulb several times until it feels firm.

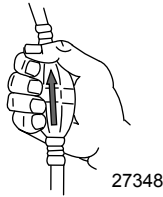

4. Set the lanyard stop switch to "RUN" position. Refer to **General Information - Lanyard Stop Switch**.

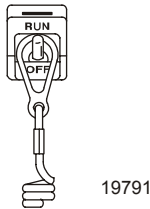

5. Shift outboard to neutral ("N") position.

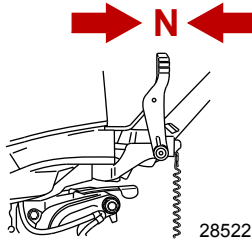

6. Set the throttle grip to start position.

# OPERATION

7. Starting a flooded engine - Set the throttle grip to half-way position.

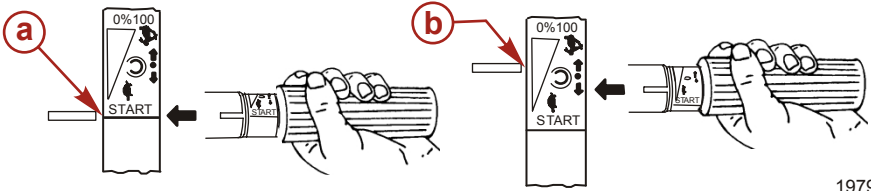

19799

- a** - Start position
- b** - Half-way position

8. Turn the ignition key to the "START" position. If the engine fails to start in ten seconds, return the key to the "ON" position, wait 30 seconds and try again.

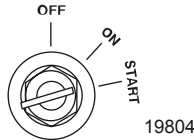

19804

## ⚠ WARNING

Rapid acceleration can result in serious injury or death from being thrown within or out of the boat. Decrease engine speed before shifting into gear.

9. Check for a steady stream of water flowing out of the water pump indicator hole.

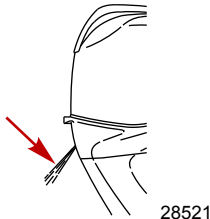

28521

# OPERATION

**IMPORTANT:** If no water is coming out of the water pump indicator hole, stop engine and check cooling water intake for obstruction. No obstruction may indicate a water pump failure or blockage in the cooling system. These conditions will cause the engine to overheat. Have the outboard checked by your dealer. Operating the engine while overheated may cause serious engine damage.

## WARMING UP ENGINE

Before beginning operation, allow the engine to warm up at idling speed for three minutes.

## Gear Shifting

**IMPORTANT:** Observe the following:

- Never shift outboard into gear unless engine speed is at idle.
- Do not shift outboard into reverse when the engine is not running.
- Your outboard has three gear shift positions to provide operation: forward, neutral (out of gear), and reverse.

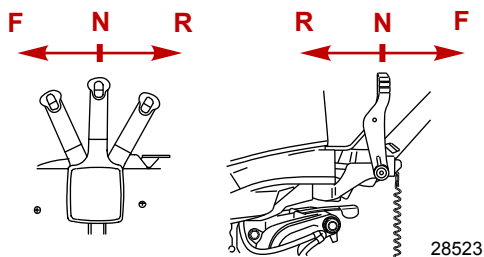

- Remote control models - When shifting, always stop at the neutral position and allow the engine speed to return to idle.

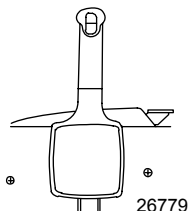

# OPERATION

- Tiller handle models - Reduce the engine speed to idle before shifting.



- Always shift the outboard into gear with a quick motion.
- After shifting the outboard into gear, advance the remote control lever or rotate the throttle grip (tiller handle) to increase speed.

## Stopping the Engine

1. **Remote control models** - Reduce engine speed and shift outboard to neutral position. Turn ignition key to "OFF" position.

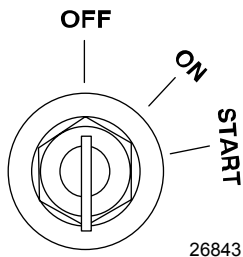

2. **Tiller handle models** - Reduce engine speed and shift outboard to neutral position. Push in the engine stop button or turn ignition key to "OFF" position.

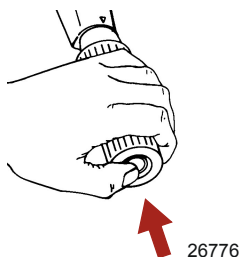

# OPERATION

## Emergency Starting

If the starter system fails, use the spare starter rope (provided) and follow procedure.

**NOTE:** *EFI models - Engine must have a fully charged battery to start the engine.*

1. Remove flywheel cover or manual starter assembly.

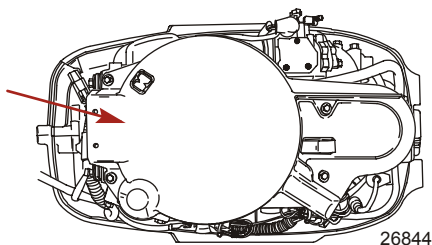

2. Shift outboard to neutral ("N") position.

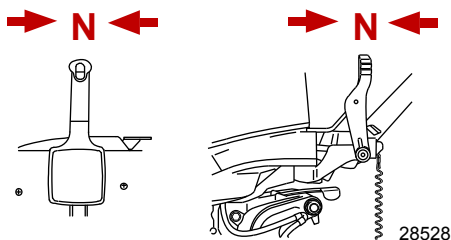

### WARNING

The neutral-speed-protection device is inoperative when starting the engine with the emergency starter rope. Set the engine speed at idle and the gear shift in neutral to prevent the outboard from starting in gear.

3. Electric start models - Turn the ignition key to "ON" position.

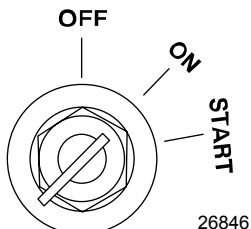

# OPERATION

## ⚠ WARNING

High voltage is present any time the key is turned on, especially when starting or operating the engine. Do not touch ignition components or metal test probes and stay clear of spark plug leads when performing live tests.

## ⚠ WARNING

The exposed moving flywheel can cause serious injury. Keep your hands, hair, clothing, tools, and other objects away from engine when starting or running the engine. Do not attempt to reinstall the flywheel cover or top cowl when engine is running.

4. Place the starter rope knot into the flywheel notch and wind the rope clockwise around the flywheel.
5. Pull the starter rope to start the engine.

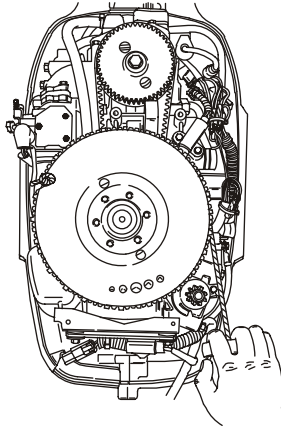

26848

# MAINTENANCE

## Outboard Care

To keep your outboard in the best operating condition, it is important that your outboard receive the periodic inspections and maintenance listed in the **Inspection and Maintenance Schedule**. We urge you to keep it maintained properly to ensure the safety of you and your passengers, and retain its dependability. Record maintenance performed in the **Maintenance Log** at the back of this book. Save all maintenance work orders and receipts.

## SELECTING REPLACEMENT PARTS FOR YOUR OUTBOARD

We recommend using original Mercury Precision or Quicksilver replacement parts and Genuine Lubricants.

## EPA Emissions Regulations

All new outboards manufactured by Mercury Marine are certified to the United States Environmental Protection Agency, as conforming to the requirements of the regulations for the control of air pollution from new outboard motors. This certification is contingent on certain adjustments set to factory standards. For this reason, the factory procedure for servicing the product must be strictly followed and, wherever practicable, returned to the original intent of the design. **Maintenance, replacement, or repair of the emission control devices and systems may be performed by any marine spark ignition (SI) engine repair establishment or individual.**

# MAINTENANCE

## EMISSION CERTIFICATION LABEL

An emission certification label, showing emission levels and engine specifications directly related to emissions, is placed on the engine at the time of manufacture.

The diagram shows a rectangular emission certification label for a Mercury engine. The label is divided into several sections. At the top left is the Mercury logo. To its right is the heading "EMISSION CONTROL INFORMATION". Below this, the text reads: "THIS ENGINE CONFORMS TO [ ] CALIFORNIA AND U.S. EPA EMISSION REGULATIONS FOR SPARK IGNITION MARINE ENGINES". The next line says: "REFER TO OWNERS MANUAL FOR REQUIRED MAINTENANCE, SPECIFICATIONS, AND ADJUSTMENTS". The label is divided into two columns. The left column contains: "IDLE SPEED (in gear): [ ]", "[ ] hp", "[ ] kw", and "SPARK PLUG: [ ]". The right column contains: "FAMILY: [ ]", "HC+NOx:FEL: [ ] g/kWh", "CO FEL: [ ] g/kWh", "GAP: [ ]", and "LOW PERM/HIGH PERM: [ ]". Ten red circles with letters a through j are placed around the label, with arrows pointing to specific fields: a points to the idle speed field, b to the hp field, c to the piston displacement field (implied by the arrow pointing to the hp field), d to the kw field, e to the date of manufacture field (implied by the arrow pointing to the hp field), f to the family number field, g to the HC+NOx emission limit field, h to the CO emission limit field, i to the spark plug and gap field, and j to the fuel line permeation field. The number "43210" is printed at the bottom right of the label.

- a - Idle speed
- b - Engine horsepower
- c - Piston displacement
- d - Engine power - kilowatts
- e - Date of manufacture
- f - Family number
- g - Regulated emission limit for the engine family
- h - Regulated emission limit for the engine family
- i - Recommended spark plug and gap
- j - Percent of fuel line permeation

## OWNER RESPONSIBILITY

The owner/operator is required to have routine engine maintenance performed to maintain emission levels within prescribed certification standards.

The owner/operator is not to modify the engine in any manner that would alter the horsepower or allow emission levels to exceed their predetermined factory specifications.

## Inspection and Maintenance Schedule

### BEFORE EACH USE

- Check engine oil level. See **Fuel & Oil - Checking and Adding Engine Oil**.



# MAINTENANCE

- Check that lanyard stop switch stops the engine.
- Visually inspect the fuel system for deterioration or leaks.
- Inspect the outboard for tightness to the boat transom. If any looseness of the outboard or mounting fasteners exist, retighten the outboard mounting fasteners. When looking for signs of looseness, look for loss of outboard transom bracket material or paint caused by movement between the outboard mounting fasteners and the outboard transom brackets. Also look for signs of movement between the outboard transom brackets and the boat transom.
- Check steering system for binding or loose components.
- Visually check steering link rod fasteners for proper tightness. See **Steering Link Rod Fasteners**.
- Check propeller blades for damage.

## AFTER EACH USE

- Flush out the outboard cooling system if operating in salt or polluted water. See **Flushing the Cooling System**.
- Wash off all salt deposits and flush out the exhaust outlet of the propeller and gearcase with fresh water if operating in saltwater.

## EVERY 100 HOURS OF USE OR ONCE YEARLY, WHICHEVER OCCURS FIRST

- Lubricate all lubrication points. Lubricate more frequently when used in saltwater. See **Lubrication Points**.
- Change engine oil and replace the oil filter. The oil should be changed more often when the engine is operated under adverse conditions such as extended trolling. See **Changing Engine Oil**.
- Inspect thermostat visually for corrosion and broken spring. Make sure thermostat closes completely at room temperature.<sup>1</sup>
- Check engine fuel filter for contaminants. See **Fuel System**.
- Check engine timing setup.<sup>1</sup>

1. These items should be serviced by an authorized dealer.

# MAINTENANCE

- Check corrosion control anodes. Check more frequently when used in saltwater. See **Corrosion Control Anodes**.
- Drain and replace gearcase lubricant. See **Gearcase Lubrication**.
- Lubricate splines on the driveshaft.<sup>1</sup>
- Check power trim fluid. See **Checking Power Trim Fluid**.
- Inspect battery. See **Battery Inspection**.
- Check control cable adjustments.<sup>1</sup>
- Inspect timing belt. See **Timing Belt Inspection**.
- Check tightness of bolts, nuts, and other fasteners.
- Check cowl seals to make sure seals are intact and not damaged.
- Check internal cowl sound reduction foam (if equipped) to make sure foam is intact and not damaged.
- Check that the intake silencer (if equipped) is in place.
- Check that the idle relief muffler (if equipped) is in place.
- Check for loose hose clamps and rubber boots (if equipped) on the air intake assembly.

## EVERY 300 HOURS OF USE OR THREE YEARS

- Replace spark plugs at first 300 hours or third year. After that, inspect spark plugs every 300 hours or three years. Replace spark plugs as needed. See **Spark Plug Inspection and Replacement**.
- Replace water pump impeller (more often if overheating occurs or reduced water pressure is noted).<sup>1</sup>
- Check and adjust valve clearance, if necessary.<sup>1</sup>

## BEFORE PERIODS OF STORAGE

- Refer to storage procedure. See **Storage** section.

## Flushing the Cooling System

Flush the internal water passages of the outboard with fresh water after each use in salt, polluted, or muddy water. This will help prevent a buildup of deposits from clogging the internal water passages.

# MAINTENANCE

**IMPORTANT:** The engine must be run during flushing in order to open the thermostat and circulate water through the water passages.

## WARNING

Rotating propellers can cause serious injury or death. Never operate the boat out of the water with a propeller installed. Before installing or removing a propeller, place the drive unit in neutral and engage the lanyard stop switch to prevent the engine from starting. Place a block of wood between the propeller blade and the anti-ventilation plate.

1. Place the outboard in either the operating position (vertical) or in a tilted position.
2. Remove the propeller. Refer to **Propeller Replacement**.
3. Thread a water hose into the rear fitting. Partially open the water tap (1/2 maximum). Do not open the water tap all the way as this allows a high pressure flow of water.

**IMPORTANT:** Do not run engine above idle when flushing.

4. Shift the outboard into neutral. Start the engine and flush the cooling system for at least five minutes. Keep the engine speed at idle.
5. Stop the engine. Turn off the water and remove the hose. Reinstall the propeller.

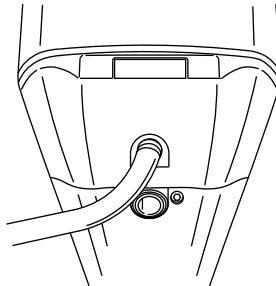

28518

# MAINTENANCE

## Top Cowl Removal and Installation

### REMOVAL

1. Pull out the rear lock lever and remove the top cowl.



28439

### INSTALLATION

1. Lower the top cowl over the engine.
2. Bring the front of the cowl down first and engage the front hook. Lower the cowl into its seated position and apply downward pressure to the back of the cowl to lock it in place. Gently pull up on the back of cowl to make sure it is securely fastened.



28445

## Exterior Care

Your outboard is protected with a durable baked enamel finish. Clean and wax often using marine cleaners and waxes.

# MAINTENANCE

## Battery Inspection

The battery should be inspected at periodic intervals to ensure proper engine starting capability.

**IMPORTANT: Read the safety and maintenance instructions which accompany your battery.**

1. Turn off the engine before servicing the battery.
2. Ensure the battery is secure against movement.
3. Battery cable terminals should be clean, tight, and correctly installed. Positive to positive and negative to negative.
4. Ensure the battery is equipped with a nonconductive shield to prevent accidental shorting of battery terminals.

## Fuel System

### WARNING

**Fuel is flammable and explosive. Ensure that the key switch is off and the lanyard is positioned so that the engine cannot start. Do not smoke or allow sources of spark or open flame in the area while servicing. Keep the work area well ventilated and avoid prolonged exposure to vapors. Always check for leaks before attempting to start the engine, and wipe up any spilled fuel immediately.**

Before servicing any part of the fuel system, stop the engine and disconnect the battery. Drain the fuel system completely. Use an approved container to collect and store the fuel. Wipe up any spillage immediately. Material used to contain spillage must be disposed of in an approved receptacle. Any fuel system service must be performed in a well-ventilated area. Inspect any completed service work for sign of fuel leakage.

### FUEL LINE INSPECTION

Visually inspect the fuel line and primer bulb for cracks, swelling, leaks, hardness, or other signs of deterioration or damage. If any of these conditions are found, the fuel line or primer bulb must be replaced.

# MAINTENANCE

## ENGINE FUEL FILTER

Check the fuel filter for water accumulation or sediment. If water is in the fuel, remove the sight bowl and drain the water. If the filter appears to be contaminated, remove and replace.

### REMOVAL

1. Read the preceding fuel system servicing information and warning.
2. Pull out the filter assembly from the mount. Hold onto the cover to prevent it from turning and remove the sight bowl. Empty contents into an approved container.
3. Inspect the filter element. If replacement is necessary, replace the filter assembly.

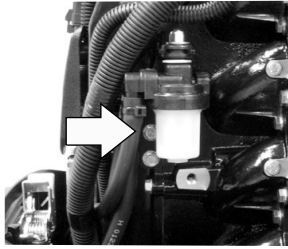
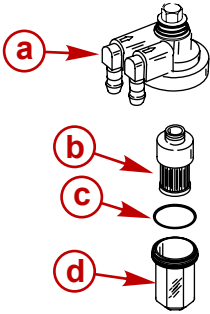

28414

- a - Cover
- b - Filter element
- c - O-ring seal
- d - Sight bowl

### INSTALLATION

**IMPORTANT:** Visually inspect for fuel leakage from the filter by squeezing the primer bulb until firm, forcing fuel into the filter.

1. Push the filter element into the cover.
2. Place the O-ring seal into its proper position on the sight bowl and screw the sight bowl hand-tight into the cover.
3. Push the filter assembly back into the mount.

# MAINTENANCE

## Steering Link Rod Fasteners

**IMPORTANT:** The steering link rod that connects the steering cable to the engine must be fastened using special washer head bolt ("e" - Part Number 10-856680) and self-locking nylon insert locknuts ("b" and "d" - Part Number 11-826709113). These locknuts must never be replaced with common nuts (nonlocking) as they will work loose and vibrate off, freeing the link rod to disengage.

### WARNING

Improper fasteners or improper installation procedures can result in loosening or disengagement of the steering link rod. This can cause a sudden, unexpected loss of boat control, resulting in serious injury or death due to occupants being thrown within or out of the boat. Always use required components and follow instructions and torque procedures.

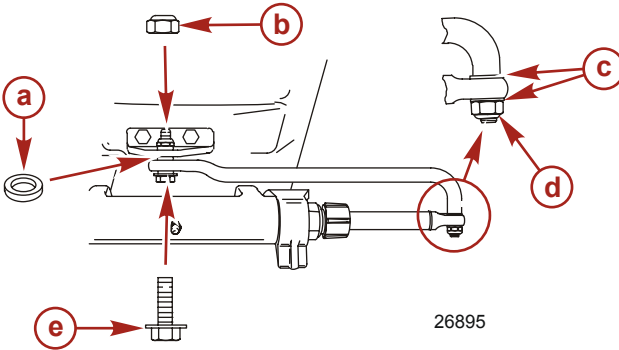

- a** - Spacer (12-71970)
- b** - Nylon insert locknut (11-826709113)
- c** - Flat washer (2)
- d** - Nylon insert locknut (11-826709113)
- e** - Special washer head bolt (10-856680)

Description	Nm	lb-in.	lb-ft
Nylon insert locknut "b"	27		20

# MAINTENANCE

Description	Nm	lb-in.	lb-ft
Nylon insert locknut "d"	Tighten until it seats, then back off 1/4 turn		
Special washer head bolt	27		20

Assemble steering link rod to steering cable with two flat washers and nylon insert locknut. Tighten locknut until it seats, then back nut off 1/4 turn.

Assemble steering link rod to engine with special washer head bolt, locknut, and spacer. First torque bolt, then locknut to specification.

## Corrosion Control Anode

The outboard has corrosion control anodes at different locations. An anode helps protect the outboard against galvanic corrosion by sacrificing its metal to be slowly corroded instead of the outboard metals.

Each anode requires periodic inspection, especially in saltwater which will accelerate the erosion. To maintain this corrosion protection, always replace the anode before it is completely eroded. Never paint or apply a protective coating on the anode, as this will reduce effectiveness of the anode.

This model has an anode installed on each side of the gearcase and one on the bottom of the transom bracket assembly.

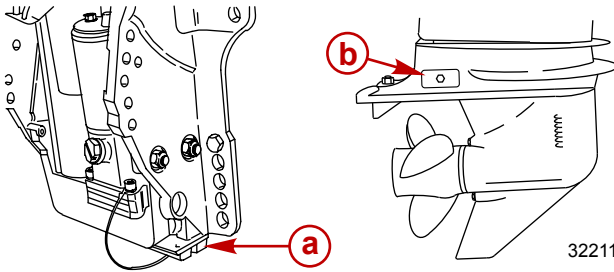

- a** - Anode on transom bracket assembly
- b** - Gearcase anodes



# MAINTENANCE

## Propeller Replacement - 87.3 mm (3-7/16 in.) Diameter Gearcase

### WARNING

Rotating the propeller shaft may cause the engine to crank over and start. To prevent this type of accidental engine starting and possible serious injury caused from being struck by a rotating propeller, always turn the ignition key or lanyard stop switch to the "OFF" position and remove the spark plug leads from the spark plugs while servicing.

1. Shift the outboard to the neutral ("N") position.

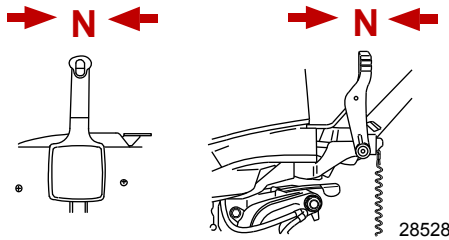

2. Remove the spark plug leads to prevent engine from starting.

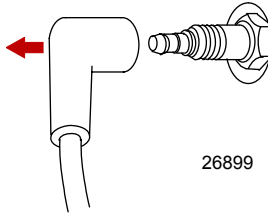

3. Straighten the bent tabs on the propeller nut retainer.

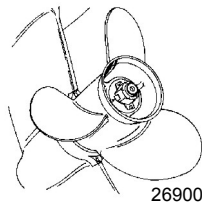

4. Place a block of wood between the gearcase and propeller to keep the propeller from turning. Remove the propeller nut.

# MAINTENANCE

- Pull the propeller straight off the shaft. If the propeller is seized to the shaft and cannot be removed, have the propeller removed by an authorized dealer.

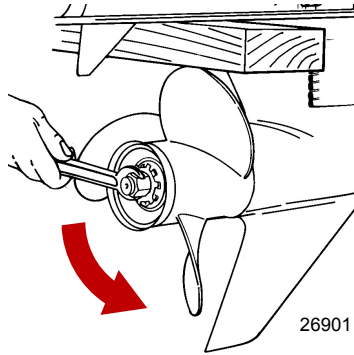

- Coat the propeller shaft with Quicksilver or Mercury Precision Lubricants Anti-Corrosion Grease or 2-4-C with Teflon.

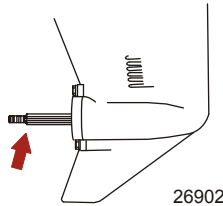

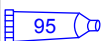
Tube Ref No.	Description	Where Used	Part No.
 94	Anti-Corrosion Grease	Propeller shaft	92-802867Q 1
 95	2-4-C with Teflon	Propeller shaft	92-802859A 1

**IMPORTANT:** To prevent the propeller hub from corroding and seizing to the propeller shaft (especially in saltwater), always apply a coat of the recommended lubricant to the entire propeller shaft at the recommended maintenance intervals, and each time the propeller is removed.

# MAINTENANCE

7. Flo-Torq I drive hub propellers - Install the forward thrust hub, propeller, propeller nut retainer, and propeller nut onto the shaft.

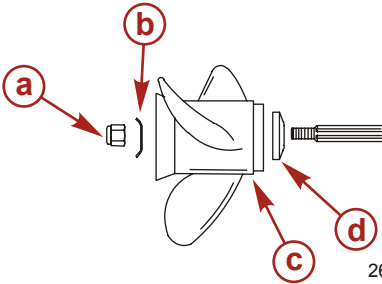

26903

- a** - Propeller nut
- b** - Propeller nut retainer
- c** - Propeller
- d** - Forward thrust hub

8. Flo-Torq II drive hub propellers - Install the forward thrust hub, propeller, replaceable drive sleeve, rear thrust hub, propeller nut retainer, and propeller nut onto the shaft.

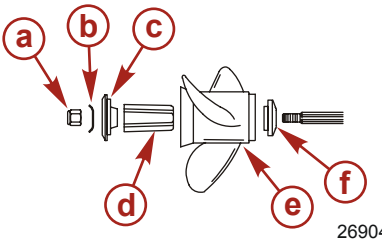

26904

- a** - Propeller nut
- b** - Propeller nut retainer
- c** - Rear thrust hub
- d** - Replaceable drive sleeve
- e** - Propeller
- f** - Forward thrust hub

9. Place the propeller nut retainer over the pins. Place a block of wood between the gearcase and the propeller and tighten the propeller nut to the specified torque.

Description	Nm	lb. in.	lb. ft.
Propeller nut	75		55

# MAINTENANCE

10. Align the flat sides of the propeller nut with the tabs on the propeller nut retainer. Secure the propeller nut by bending the tabs up and against the flats on the propeller nut.

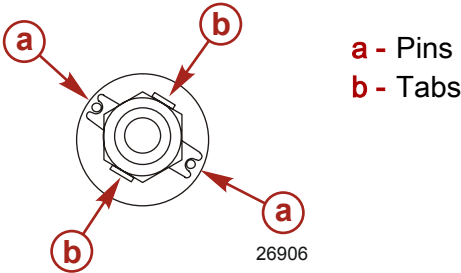

11. Reinstall the spark plug leads.

## Propeller Replacement - 108 mm (4-1/4 in.) Diameter Gearcase

### WARNING

Rotating the propeller shaft may cause the engine to crank over and start. To prevent this type of accidental engine starting and possible serious injury caused from being struck by a rotating propeller, always turn the ignition key or lanyard stop switch to the "OFF" position and remove the spark plug leads from the spark plugs while servicing.

1. Shift the outboard to the neutral ("N") position.

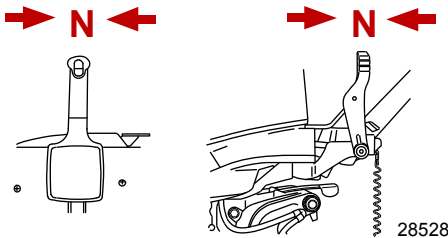

# MAINTENANCE

2. Remove the spark plug leads to prevent the engine from starting.

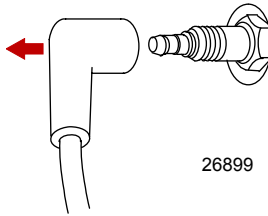

3. Straighten the bent tabs on the propeller nut retainer.

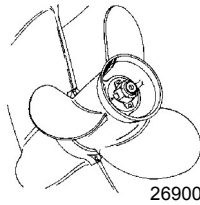

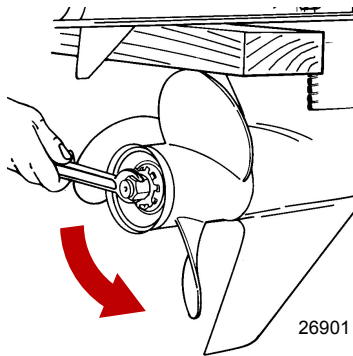

4. Place a block of wood between gearcase and propeller to keep the propeller from turning. Remove the propeller nut.
5. Pull the propeller straight off the shaft. If the propeller is seized to the shaft and cannot be removed, have the propeller removed by an authorized dealer.

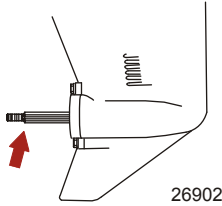

# MAINTENANCE

6. Coat the propeller shaft with Quicksilver or Mercury Precision Lubricants Anti-Corrosion Grease or 2-4-C with Teflon.



Tube Ref No.	Description	Where Used	Part No.
 94	Anti-Corrosion Grease	Propeller shaft	92-802867Q 1
 95	2-4-C with Teflon	Propeller shaft	92-802859A 1

**IMPORTANT:** To prevent the propeller hub from corroding and seizing to the propeller shaft (especially in saltwater), always apply a coat of the recommended lubricant to the entire propeller shaft at the recommended maintenance intervals, and each time the propeller is removed.

7. Flo-Torq I drive hub propellers - Install the thrust washer, propeller, continuity washer, thrust hub, propeller nut retainer, and propeller nut onto the shaft.

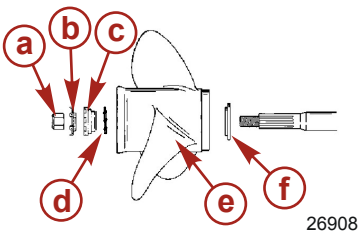

- a** - Propeller nut
- b** - Propeller nut retainer
- c** - Thrust hub
- d** - Continuity washer
- e** - Propeller
- f** - Thrust washer

# MAINTENANCE

8. Flo-Torq II drive hub propellers - Install the forward thrust hub, replaceable drive sleeve, propeller, thrust hub, propeller nut retainer, and propeller nut onto the shaft.

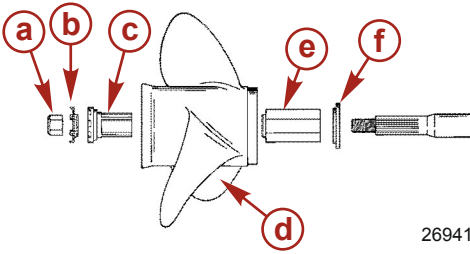

26941

- a** - Propeller nut
- b** - Propeller nut retainer
- c** - Thrust hub
- d** - Propeller
- e** - Replaceable drive sleeve
- f** - Forward thrust hub

**NOTE:** We recommend the installation of a Flo-Torq III drive hub propeller for stainless steel applications.

9. Flo-Torq III drive hub propellers - Install the forward thrust hub, replaceable drive sleeve, propeller, rear thrust hub, propeller nut retainer, and propeller nut onto the shaft.

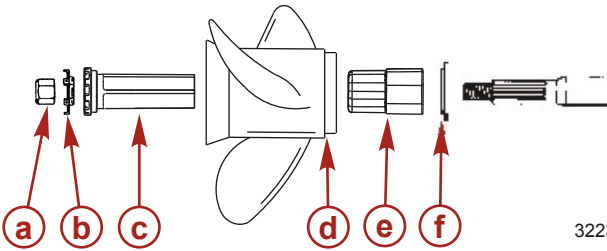

3223

- a** - Propeller nut
- b** - Propeller nut retainer
- c** - Rear thrust hub
- d** - Propeller
- e** - Replaceable drive sleeve
- f** - Forward thrust hub

10. Place a block of wood between the gearcase and propeller and torque the propeller nut to the specified torque.

Description	Nm	lb. in.	lb. ft.
Propeller nut	75		55

# MAINTENANCE

11. Secure the propeller nut by bending three of the tabs into the thrust hub grooves.

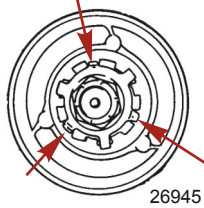

## Spark Plug Inspection and Replacement

### WARNING

Damaged spark plug boots may emit sparks which can ignite fuel vapors under the engine cowl, resulting in serious injury or death from a fire or explosion. To avoid damaging the spark plug boots, do not use any sharp object or metal tool to remove the spark plug boots.

1. Remove the spark plug boots. Twist the rubber boots slightly and pull off.

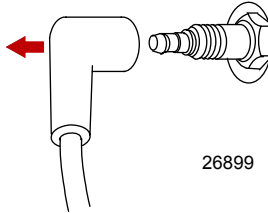

2. Remove the spark plugs to inspect. Replace spark plug if electrode is worn or the insulator is rough, cracked, broken, blistered, or fouled.

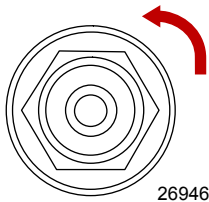



# MAINTENANCE

3. Set the spark plug gap to specification.

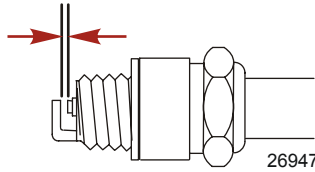

Spark Plug	
Spark plug gap	1.0 mm (0.040 in.)

4. Before installing spark plugs, clean off any dirt on the spark plug seats. Install plugs finger-tight, and then tighten 1/4 turn or torque to specifications.

Description	Nm	lb-in.	lb-ft
Spark plug	27		20

## Fuse Replacement

**IMPORTANT: Always carry spare 20 amp fuses.**

The electrical wiring circuits on the outboard are protected from overload by fuses in the wiring. If a fuse is blown, try to locate and correct the cause of the overload. If the cause is not found, the fuse may blow again.

# MAINTENANCE

Open the fuse holder and look at the silver colored band inside the fuse. If the band is broken, replace the fuse. Replace fuse with a new fuse with the same rating.

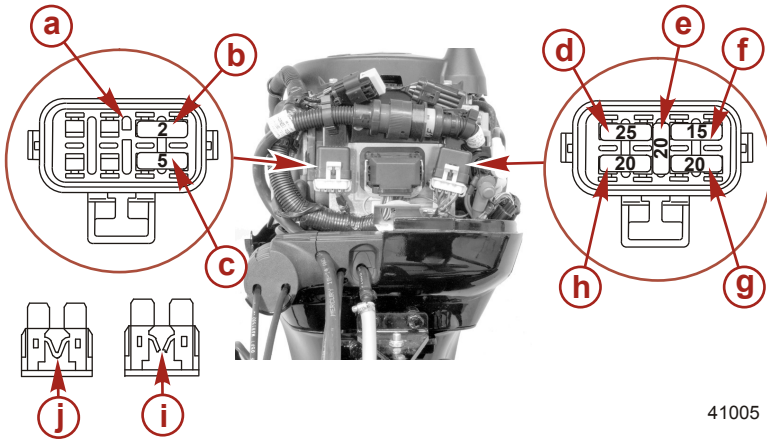

41005

- a** - Spare fuse slot
- b** - Diagnostic circuit 4 pin connector - 2 amp fuse
- c** - SmartCraft data bus circuit - 5 amp fuse
- d** - Main circuit - 25 amp fuse
- e** - Spare 20 amp fuse
- f** - Main relay/accessories - 15 amp fuse
- g** - Ignition coil circuit - 20 amp fuse
- h** - Fuel pump/idle air control/fuel injector circuits - 20 amp fuse
- i** - Blown fuse
- j** - Good fuse

## Timing Belt Inspection

1. Inspect the timing belt and have it replaced by an authorized dealer if any of the following conditions are found.
  - a. Cracks in the back of the belt or in the base of the belt teeth.
  - b. Excessive wear at the roots of the cogs.
  - c. Rubber portion swollen by oil.
  - d. Belt surfaces roughened.

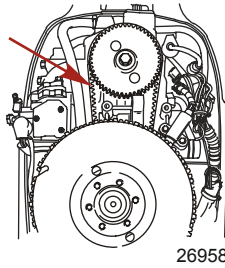

# MAINTENANCE

e. Signs of wear on edges or outer surfaces of belt.





## Lubrication Points

1. Lubricate the following with Quicksilver or Mercury Precision Lubricants Anti-Corrosion Grease or 2-4-C with Teflon.

Tube Ref No.	Description	Where Used	Part No.
 94	Anti-Corrosion Grease	Propeller shaft	92-802867Q 1
 95	2-4-C with Teflon	Propeller shaft	92-802859A 1

2. Lubricate the following with Quicksilver or Mercury Precision Lubricants 2-4-C with Teflon or Special Lubricant 101.

Tube Ref No.	Description	Where Used	Part No.
 95	2-4-C with Teflon	Tilt support lever, swivel bracket, tilt tube, steering cable grease fitting	92-802859A 1
 34	Special Lubricant 101	Tilt support lever, swivel bracket, tilt tube, co-pilot shaft, steering cable grease fitting	92-802865Q02

- Tilt support lever - Lubricate through fitting.

# MAINTENANCE

- Swivel bracket - Lubricate through fitting.

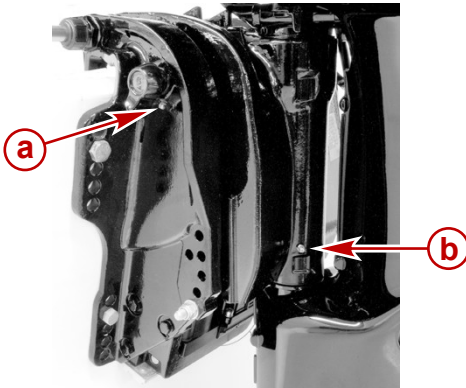

- a** - Tilt support lever
- b** - Swivel bracket

28466

- Tilt tube - Lubricate through fitting.

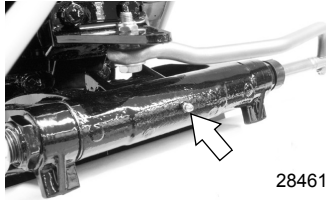

28461

- Co-pilot shaft (tiller handle models) - Lubricate through fitting. Move the steering friction lever back and forth while lubricating.

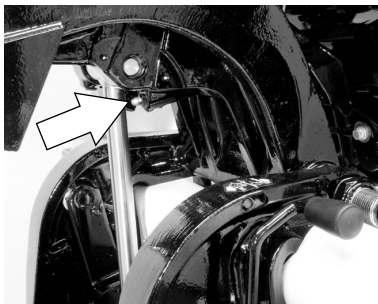

28823

# MAINTENANCE

## ⚠ WARNING

Incorrect cable lubrication can cause hydraulic lock, leading to serious injury or death from loss of boat control. Completely retract the end of the steering cable before applying lubricant.

- Steering cable grease fitting (if equipped) - Rotate steering wheel to fully retract the steering cable end into the outboard tilt tube. Lubricate through fitting.

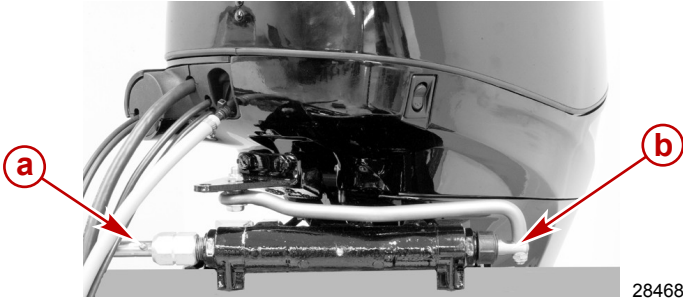

**a** - Fitting

**b** - Steering cable end

### 3. Lubricate the following with lightweight oil.

- Steering link rod pivot points - Lubricate points.

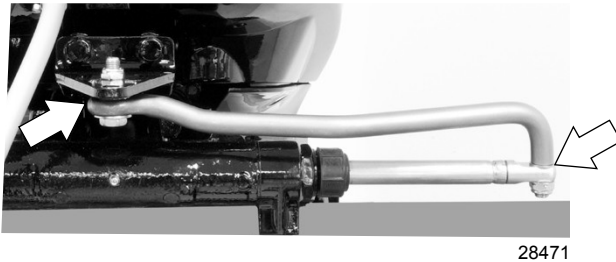

# MAINTENANCE

## Checking Power Trim Fluid

1. Tilt the outboard to the full up position and engage the tilt support lock.

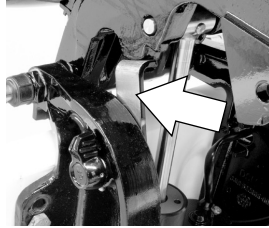

28474

2. Remove the fill cap and check the fluid level. The fluid level should be even with the bottom of the fill hole. Add Quicksilver or Mercury Precision Lubricants Power Trim and Steering Fluid. If not available, use automotive automatic transmission fluid (ATF).

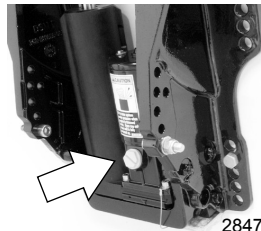

28476

Tube Ref No.	Description	Where Used	Part No.
 114	Power Trim and Steering Fluid	Power trim reservoir	92-858074K01

## Changing Engine Oil

### ENGINE OIL CAPACITY

	Capacity	Fluid Type
Engine oil	3.0 Liter (3 U.S. Quarts)	Mercury Precision Parts or Quicksilver Synthetic Blend 25W-40 4-Stroke Outboard Oil
		Mercury Precision Parts or Quicksilver 10W-30 4-Stroke Outboard Oil

# MAINTENANCE

## OIL CHANGING PROCEDURE

1. Tilt the outboard up to the trailer position.
2. Turn the outboard so the drain hole is facing downward.  
Remove the drain plug and drain the engine oil into an appropriate container. Lubricate the seal on the drain plug with oil and reinstall.

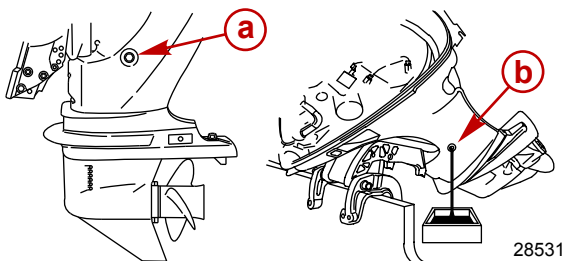

**a** - Drain plug

**b** - Drain hole

## CHANGING OIL FILTER

1. Place a rag or towel below the oil filter to absorb any spilled oil.
2. Unscrew the old filter by turning the filter to the left.
3. Clean the mounting base. Apply a film of clean oil to the filter gasket. Do not use grease. Screw the new filter on until the gasket contacts the base, then tighten  $3/4$  to 1 turn.

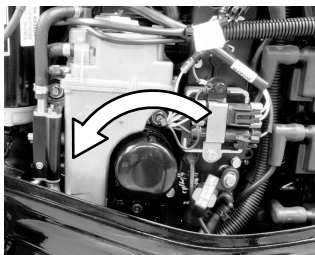

## OIL FILLING

1. Remove the oil fill cap and add oil to the proper operating level.

# MAINTENANCE

2. Idle the engine for five minutes and check for leaks. Stop the engine and check the oil level on the dipstick. Add oil if necessary.

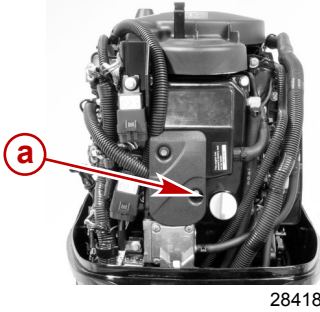

**a** - Oil fill cap

## Gearcase Lubrication - For 87.3 mm (3-7/16 in.) Diameter Gearcase

When adding or changing gearcase lubricant, visually check for the presence of water in the lubricant. If water is present, it may have settled to the bottom and will drain out prior to the lubricant, or it may be mixed with the lubricant, giving it a milky colored appearance. If water is noticed, have the gearcase checked by your dealer. Water in the lubricant may result in premature bearing failure or, in freezing temperatures, will turn to ice and damage the gearcase.

Examine the drained gearcase lubricant for metal particles. A small amount of fine metal particles indicates normal gear wear. An excessive amount of metal filings or larger particles (chips) may indicate abnormal gear wear and should be checked by an authorized dealer.

## DRAINING GEARCASE

1. Place the outboard in a vertical operating position.
2. Place a drain pan below the outboard.



# MAINTENANCE

3. Remove the vent plug and fill/drain plug and drain the lubricant.

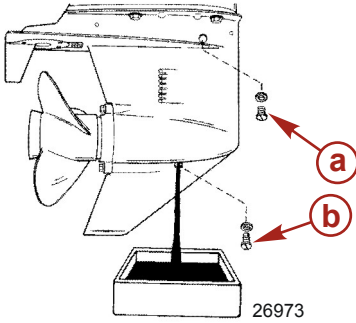

- a - Vent plug
- b - Fill/drain plug

## GEARCASE LUBRICANT CAPACITY

Gearcase lubricant capacity is approximately 340 ml (11.5 fl oz).

## CHECKING GEARCASE LUBRICANT LEVEL AND REFILLING GEARCASE

1. Place the outboard in a vertical operating position.
2. Remove the vent plug.
3. Place the lubricant tube into the fill hole and add lubricant until it appears at the vent hole.

**IMPORTANT: Replace sealing washers if damaged.**

4. Stop adding lubricant. Install the vent plug and sealing washer before removing the lubricant tube.

# MAINTENANCE

5. Remove the lubricant tube and install a cleaned fill/drain plug and sealing washer.

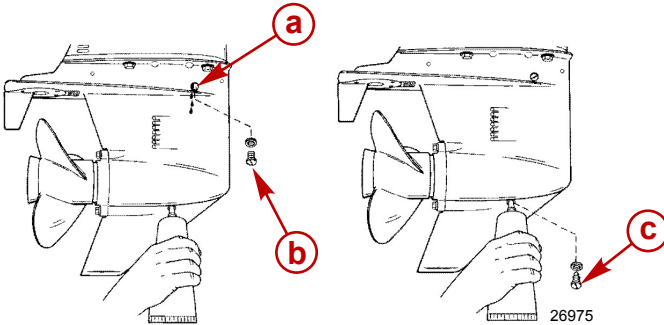

- a - Vent hole
- b - Vent plug
- c - Fill/drain plug

## Gearcase Lubrication - For 108 mm (4-1/4 in.) Diameter Gearcase

When adding or changing gearcase lubricant, visually check for the presence of water in the lubricant. If water is present, it may have settled to the bottom and will drain out prior to the lubricant, or it may be mixed with the lubricant, giving it a milky colored appearance. If water is noticed, have the gearcase checked by your dealer. Water in the lubricant may result in premature bearing failure or, in freezing temperatures, will turn to ice and damage the gearcase.

Examine the drained gearcase lubricant for metal particles. A small amount of fine metal particles indicates normal gear wear. An excessive amount of metal filings or larger particles (chips) may indicate abnormal gear wear and should be checked by an authorized dealer.

### DRAINING GEARCASE

1. Place the outboard in a vertical operating position.
2. Place a drain pan below the outboard.

# MAINTENANCE

3. Remove the vent plugs and fill/drain plug and drain the lubricant.

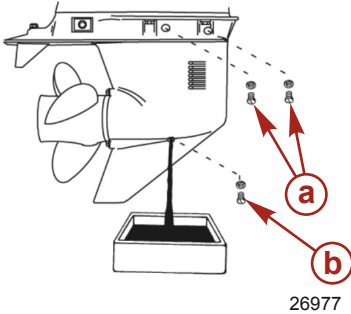

- a - Vent plugs
- b - Fill/drain plug

## GEARCASE LUBRICANT CAPACITY

Gearcase lubricant capacity is approximately 710 ml (24 fl oz).

## CHECKING LUBRICANT LEVEL AND FILLING GEARCASE

1. Place the outboard in a vertical operating position.
2. Remove the front vent plug and rear vent plug.
3. Place the lubricant tube into the fill hole and add lubricant until it appears at the front vent hole. At this time install the front vent plug and sealing washer.
4. Continue adding lubricant until it appears at the rear vent hole.
5. Stop adding lubricant. Install the rear vent plug and sealing washer before removing the lubricant tube.

# MAINTENANCE

6. Remove the lubricant tube and install a cleaned fill/drain plug and sealing washer.

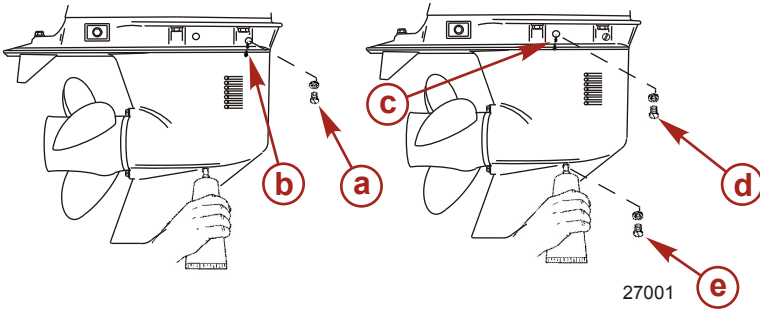

- a** - Front vent plug
- b** - Front vent hole
- c** - Rear vent hole
- d** - Rear vent plug
- e** - Fill/drain plug and sealing washer

## Submerged Outboard

A submerged outboard will require service within a few hours by an authorized dealer once the outboard is recovered from the water. This immediate attention by a servicing dealer is necessary once the engine is exposed to the atmosphere to minimize internal corrosion damage to the engine.

# STORAGE

## Storage Preparation

The major consideration in preparing your outboard for storage is to protect it from rust, corrosion, and damage caused by freezing of trapped water.

The following storage procedures should be followed to prepare your outboard for out of season storage or prolonged storage (two months or longer).

### *NOTICE*

Without sufficient cooling water, the engine, the water pump, and other components will overheat and suffer damage. Provide a sufficient supply of water to the water inlets during operation.

## FUEL SYSTEM

**IMPORTANT:** Gasoline containing alcohol (ethanol or methanol) can cause a formation of acid during storage and can damage the fuel system. If the gasoline being used contains alcohol, it is advisable to drain as much of the remaining gasoline as possible from the fuel tank, remote fuel line, and engine fuel system.

Fill the fuel tank and engine fuel system with treated (stabilized) fuel to help prevent formation of varnish and gum. Proceed with following instructions.

- Portable fuel tank - Pour the required amount of gasoline stabilizer (follow instructions on container) into fuel tank. Tip fuel tank back and forth to mix stabilizer with the fuel.
- Permanently installed fuel tank - Pour the required amount of gasoline stabilizer (follow instructions on container) into a separate container and mix with approximately one liter (one quart) of gasoline. Pour this mixture into fuel tank.
- Remove the fuel filter sight bowl and empty contents in a suitable container. Refer to **Maintenance - Fuel System** for removal and installation of filter. Add 3 cc (1/2 tsp.) of gasoline stabilizer into the fuel filter sight bowl and reinstall.
- Place the outboard in water or connect flushing attachment for circulating cooling water. Run the engine for 15 minutes to fill the engine fuel system.

# STORAGE

## Protecting External Outboard Components

- Lubricate all outboard components listed in **Maintenance - Inspection and Maintenance Schedule**.
- Touch up any paint nicks. See your dealer for touch-up paint.
- Spray Quicksilver or Mercury Precision Lubricants Corrosion Guard on external metal surfaces (except corrosion control anodes).

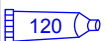
Tube Ref No.	Description	Where Used	Part No.
 120	Corrosion Guard	External metal surfaces	92-802878 55

## Protecting Internal Engine Components

- Remove the spark plugs and add approximately 30 ml (1 oz.) of engine oil or inject a five second spray of storage seal into each spark plug hole.
- Rotate the flywheel manually several times to distribute the oil in the cylinders. Reinstall spark plugs.
- Change the engine oil.

## Gearcase

- Drain and refill the gearcase lubricant (refer to **Gearcase Lubrication**).

## Positioning Outboard for Storage

Store outboard in an upright (vertical) position to allow water to drain out of the outboard.

### *NOTICE*

Storing the outboard in a tilted position can damage the outboard. Water trapped in the cooling passages or rain water collected in the propeller exhaust outlet in the gearcase can freeze. Store the outboard in the full down position.

# STORAGE

## Battery Storage

- Follow the battery manufacturer's instructions for storage and recharging.
- Remove the battery from the boat and check water level. Recharge if necessary.
- Store the battery in a cool, dry place.
- Periodically check the water level and recharge the battery during storage.

# TROUBLESHOOTING

## Starter Motor Will Not Crank the Engine (Electric Start Models)

### POSSIBLE CAUSES

- Blown fuse in the starting circuit. Refer to **Maintenance** section.
- Outboard is not shifted to neutral position.
- Weak battery or battery connections are loose or corroded.
- Ignition key switch failure.
- Wiring or electrical connection faulty.
- Starter motor or starter solenoid failure.

## Engine Will Not Start

### POSSIBLE CAUSES

- Lanyard stop switch not in "RUN" position.
- Incorrect starting procedure. Refer to **Operation** section.
- Old or contaminated gasoline.
- Engine flooded. Refer to **Operation** section.
- Fuel is not reaching the engine.
  - a. Fuel tank is empty.
  - b. Fuel tank vent not open or restricted.
  - c. Fuel line is disconnected or kinked.
  - d. Primer bulb not squeezed.
  - e. Primer bulb check valve is faulty.
  - f. Fuel filter is obstructed. Refer to **Maintenance** section.
  - g. Fuel pump failure.
  - h. Fuel tank filter obstructed.
- Blown fuse. Refer to **Maintenance** section.
- Ignition system component failure.
- Spark plugs fouled or defective. Refer to **Maintenance** section.



# TROUBLESHOOTING

## Engine Runs Erratically

### POSSIBLE CAUSES

- Guardian System activated. Refer to **Features & Controls - Warning System**.
- Spark plugs fouled or defective. Refer to **Maintenance** section.
- Incorrect setup and adjustments.
- Fuel is being restricted to the engine.
  - a. Engine fuel filter is obstructed. Refer to **Maintenance** section.
  - b. Fuel tank filter obstructed.
  - c. Stuck anti-siphon valve located on permanently built-in type fuel tanks.
  - d. Fuel line is kinked or pinched.
- Fuel pump failure.
- Ignition system component failure.
- Fuel injection component failure (EFI Models).

## Performance Loss

### POSSIBLE CAUSES

- Engine Guardian System activated. Refer to **Features & Controls - Warning System**.
- Throttle not fully open.
- Damaged or improper size propeller.
- Incorrect engine timing, adjustments, or setup.
- Boat overloaded or load improperly distributed.
- Excessive water in bilge.
- Boat bottom is dirty or damaged.

## Battery Will Not Hold Charge

### POSSIBLE CAUSES

- Battery connections are loose or corroded.
- Low electrolyte level in battery.
- Worn out or inefficient battery.

# TROUBLESHOOTING

- Excessive use of electrical accessories.
- Defective rectifier, alternator, or voltage regulator.

# OWNER SERVICE ASSISTANCE

## Local Repair Service

Always return your outboard to your local authorized dealer should the need for service arise. Only he has the factory trained mechanics, knowledge, special tools, equipment, and genuine parts and accessories to properly service your engine should the need occur. He knows your engine best.

## Service Away from Home

If you are away from your local dealer and the need arises for service, contact the nearest authorized dealer. Refer to the Yellow Pages of the telephone directory. If, for any reason, you cannot obtain service, contact the nearest Mercury Marine Service Office.

## Parts and Accessories Inquiries

All inquiries concerning genuine replacement parts and accessories should be directed to your local authorized dealer. The dealer has the necessary information to order parts and accessories for you. When inquiring on parts and accessories, the dealer requires the model and serial number to order the correct parts.

## Service Assistance

Your satisfaction with your outboard product is very important to your dealer and to us. If you ever have a problem, question or concern about your outboard product, contact your dealer or any authorized Mercury Marine dealership. If additional assistance is required, take these steps.

1. Talk with the dealership's sales manager or service manager. If this has already been done, then contact the owner of the dealership.
2. Should you have a question, concern, or problem that cannot be resolved by your dealership, please contact Mercury Marine Service Office for assistance. Mercury Marine will work with you and your dealership to resolve all problems.

The following information will be needed by the service office:

- Your name and address
- Daytime telephone number

# OWNER SERVICE ASSISTANCE

- Model and serial number of your outboard
- The name and address of your dealership
- Nature of problem

## Mercury Marine Service Offices

For assistance, call, fax, or write. Please include your daytime telephone number with mail and fax correspondence.

<b>United States, Canada</b>		
Telephone	English - (920) 929-5040 Français - (905) 636-4751	Mercury Marine W6250 W. Pioneer Road P.O. Box 1939 Fond du Lac, WI 54936-1939
Fax	English - (920) 929-5893 Français - (905) 636-1704	
Website	www.mercurymarine.com	

<b>Australia, Pacific</b>		
Telephone	(61) (3) 9791-5822	Brunswick Asia Pacific Group 132-140 Frankston Road Dandenong, Victoria 3164 Australia
Fax	(61) (3) 9706-7228	

<b>Europe, Middle East, Africa</b>		
Telephone	(32) (87) 32 • 32 • 11	Brunswick Marine Europe Parc Industriel de Petit-Rechain B-4800 Verviers, Belgium
Fax	(32) (87) 31 • 19 • 65	

<b>Mexico, Central America, South America, Caribbean</b>		
Telephone	(954) 744-3500	Mercury Marine 11650 Interchange Circle North Miramar, FL 33025 U.S.A.
Fax	(954) 744-3535	

<b>Japan</b>		
Telephone	072-233-8888	Kisaka Co., Ltd. 4-130 Kannabecho Sakai-shi Sakai-ku 5900984 Osaka, Japan
Fax	072-233-8833	

## OWNER SERVICE ASSISTANCE

<b>Asia, Singapore</b>		
Telephone	(65) 65466160	Brunswick Asia Pacific Group T/A Mercury Marine Singapore Pte Ltd 29 Loyang Drive Singapore, 508944
Fax	(65) 65467789	

# OUTBOARD INSTALLATION

## Installation Information

### BOAT HORSEPOWER CAPACITY

#### WARNING

Exceeding the boat's maximum horsepower rating can cause serious injury or death. Overpowering the boat can affect boat control and flotation characteristics or break the transom. Do not install an engine that exceeds the boat's maximum power rating.

Do not overpower or overload your boat. Most boats will carry a required capacity plate indicating the maximum acceptable power and load as determined by the manufacturer following certain federal guidelines. If in doubt, contact your dealer or the boat manufacturer.

U.S. COAST GUARD CAPACITY	
MAXIMUM HORSEPOWER	XXX
MAXIMUM PERSON CAPACITY (POUNDS)	XXX
MAXIMUM WEIGHT CAPACITY	XXX

26777

### START IN GEAR PROTECTION

#### WARNING

Starting the engine with the drive in gear can cause serious injury or death. Never operate a boat that does not have a neutral-safety-protection device.

The remote control connected to the outboard must be equipped with a start in neutral only protection device. This prevents the engine from starting in gear.

# OUTBOARD INSTALLATION

## SELECTING ACCESSORIES FOR YOUR OUTBOARD

Genuine Mercury Precision or Quicksilver Accessories have been specifically designed and tested for your outboard. These accessories are available from Mercury Marine dealers.

**IMPORTANT: Check with your dealer before installing accessories. The misuse of approved accessories or the use of nonapproved accessories can damage the product.**

Some accessories not manufactured or sold by Mercury Marine are not designed to be safely used with your outboard or outboard operating system. Acquire and read the installation, operation and maintenance manuals for all your selected accessories.

## LOW PERMEATION FUEL HOSE REQUIREMENT

Required for outboards manufactured for sale, sold, or offered for sale in the United States.

- The Environmental Protection Agency (EPA) requires that any outboard manufactured after January 1, 2009 must use low permeation fuel hose for the primary fuel hose connecting the fuel tank to the outboard.
- Low permeation hose is USCG Type B1-15 or Type A1-15, defined as not exceeding  $15/\text{gm}^2/24 \text{ h}$  with CE 10 fuel at  $23^\circ\text{C}$  as specified in SAE J 1527 - marine fuel hose.

## ELECTRIC FUEL PUMP

If an electric fuel pump is used, the fuel pressure must not exceed 27.58 kPa (4 psi) at the engine. If necessary, install a pressure regulator to regulate the pressure.

# OUTBOARD INSTALLATION

## INSTALLATION SPECIFICATIONS

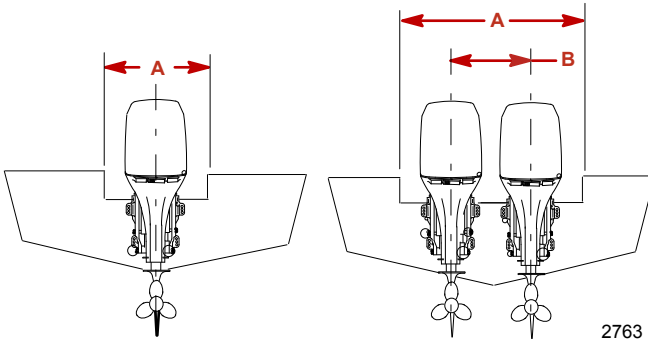

- a** - Minimum transom opening
- b** - Engine centerline for dual engines

Minimum Transom Opening	
Single engine (remote)	48.3 cm (19 in.)
Single engine (tiller)	76.2 cm (30 in.)
Dual engines	101.6 cm (40 in.)

Engine Centerline	
Minimum	66 cm (26 in.)



# OUTBOARD INSTALLATION

## LIFTING OUTBOARD

Use the lifting eye on the engine.



28510

## INSTALLING OUTBOARD

### Drilling Outboard Mounting Holes

1. Mark four mounting holes on the transom using the transom drill fixture.

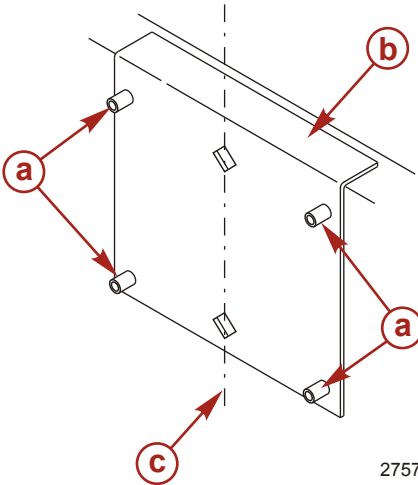

- a** - Drill guide holes
- b** - Transom drilling fixture
- c** - Transom centerline

2757

# OUTBOARD INSTALLATION

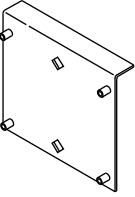
Transom Drilling Fixture	91-98234A2
 5489	Aids in engine installation by acting as a template for engine mounting holes.

2. Drill four 13.5 mm (17/32 in.) mounting holes.

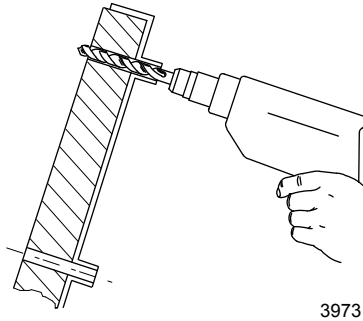

## Checking Boat Transom Construction

**IMPORTANT:** Determine the strength of the boat transom. The outboard mounting locknuts and bolts should be able to hold 75 Nm (55 lb-ft) of torque without the boat transom yielding or cracking. If the boat transom yields or cracks under this torque, the construction of the transom may not be adequate. The boat transom must be strengthened or the load carrying area increased.

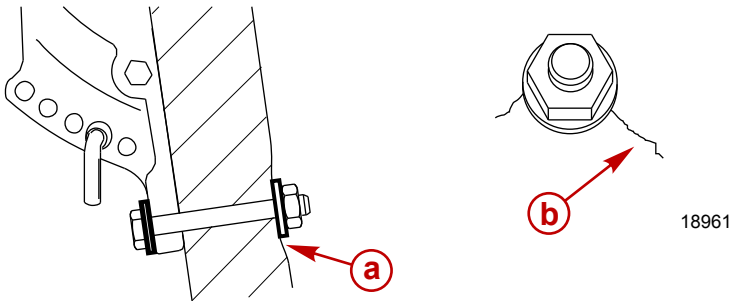

**a** - Transom yielding under bolt torque

**b** - Transom cracking under bolt torque

# OUTBOARD INSTALLATION

When first determining transom strength, use a dial torque wrench. If the bolt or nut continues to turn without the torque reading on the dial increasing, it is an indication that the transom is yielding. The load area can be increased by using a larger washer or a transom reinforcement plate.

**NOTE:** *The inside holes on the transom reinforcement plate are for the lower transom bolts and the outside holes are for the upper transom bolts.*

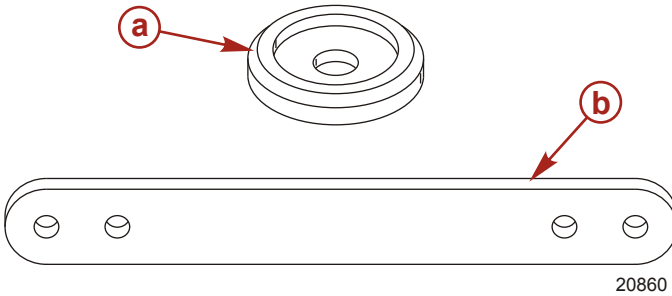

- a** - Large transom washer
- b** - Transom reinforcement plate

Description	Part Number
Large transom washer	67-896392
Transom reinforcement plate	67-896305

## Fastening the Outboard to the Transom

1. Install the outboard so that the anti-ventilation plate is in-line or within 25 mm (1 in.) below the bottom of the boat.

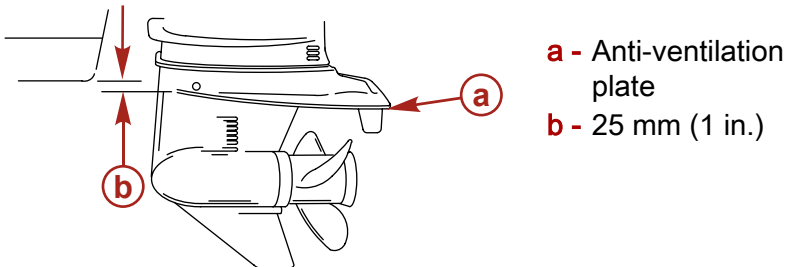

- a** - Anti-ventilation plate
- b** - 25 mm (1 in.)

8045

2. Apply marine sealer to the shanks of bolts, not the threads.

# OUTBOARD INSTALLATION

- Fasten the outboard with the provided mounting hardware.  
Tighten the locknuts to the specified torque.

**NOTE:** For a more accurate torque, turn/tighten the mounting locknuts rather than turning the mounting bolts.

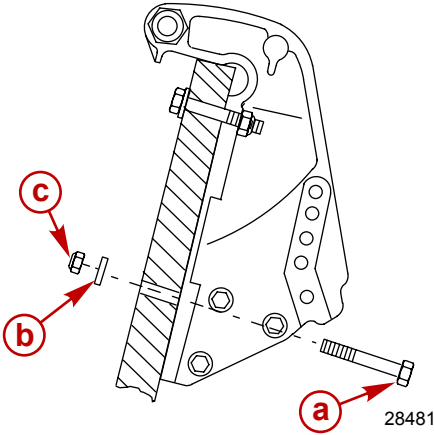



- a - 1/2 in. diameter bolt (4)
- b - Flat washer (4)
- c - Locknut (4)

Description	Nm	lb. in.	lb. ft.
Outboard mounting locknuts and bolts	75		55

## STEERING CABLE - STARBOARD SIDE ROUTED CABLE

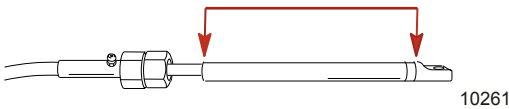
- Lubricate the entire cable end.



Tube Ref No.	Description	Where Used	Part No.
 95	2-4-C Marine Lubricant with Teflon	Steering cable end	92-802859A 1

# OUTBOARD INSTALLATION

2. Insert the steering cable into the tilt tube.



28507

3. Tighten the nut to the specified torque.



29506

Description	Nm	lb. in.	lb. ft.
Nut	47.5		35

## STEERING CABLE SEAL

1. Mark tilt tube 6.4 mm (0.25 in.) from end. Install seal components.

# OUTBOARD INSTALLATION

2. Thread cap to the mark.

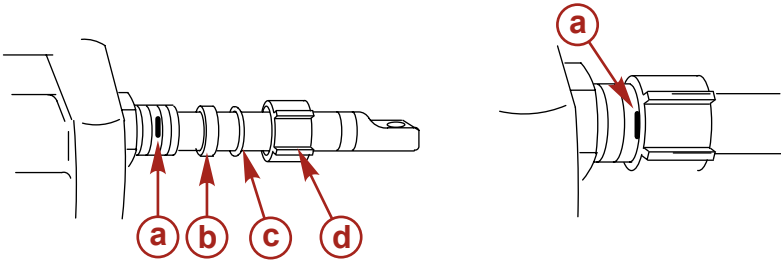

8041

- a** - 6.4 mm (1/4 in.)
- b** - Plastic spacer
- c** - O-ring seal
- d** - Cap

## STEERING LINK ROD FASTENERS

**IMPORTANT:** The steering link rod that connects the steering cable to the engine must be fastened using special washer head bolt ("a" - Part Number 10-856680) and self-locking nylon insert locknuts ("b" & "e" - Part Number 11-826709113). These locknuts must never be replaced with common nuts (non-locking) as they will work loose and vibrate off, freeing the link rod to disengage.

# OUTBOARD INSTALLATION

## ⚠ WARNING

Improper fasteners or improper installation procedures can result in loosening or disengagement of the steering link rod. This can cause a sudden, unexpected loss of boat control, resulting in serious injury or death due to occupants being thrown within or out of the boat. Always use required components and follow instructions and torque procedures.

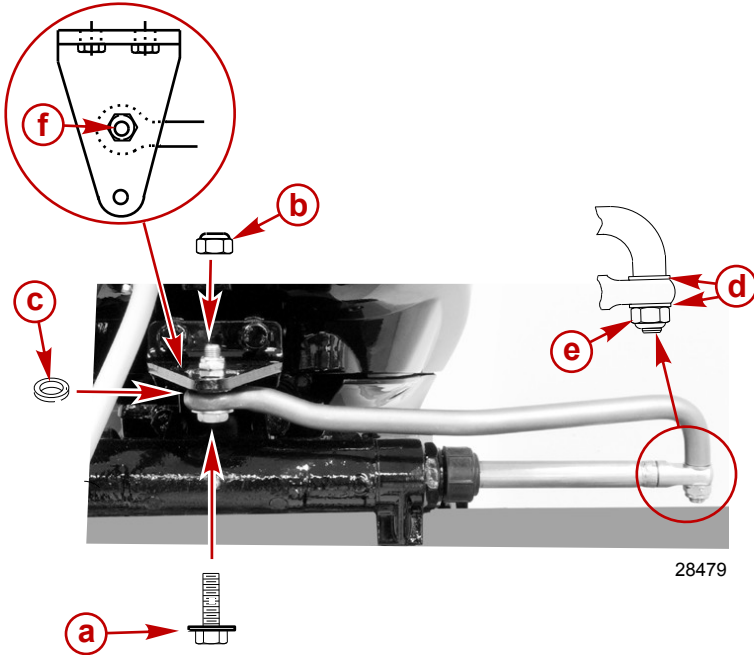

28479

- a** - Special washer head bolt (10-856680)
- b** - Nylon insert locknut (11-826709113)
- c** - Spacer (12-71970)
- d** - Flat washer (2)
- e** - Nylon insert locknut (11-826709113)
- f** - Use middle hole - steer outboard to the side to gain hole access

Description	Nm	lb. in.	lb. ft.
Special washer head bolt	27		20

# OUTBOARD INSTALLATION

Description	Nm	lb. in.	lb. ft.
Nylon insert locknut "b"	27		20
Nylon insert locknut "e"	Tighten until it seats, then back off 1/4 turn		

Assemble steering link rod to steering cable with two flat washers and nylon insert locknut. Tighten locknut until it seats, then back nut off 1/4 turn.

Assemble steering link rod to engine with special washer head bolt, locknut and spacer. First torque bolt, then torque locknut to specifications.

## Fuel Hose Connection - Remote Control Models

### REMOTE FUEL HOSE SIZE

Minimum fuel hose inside diameter (ID) is 8 mm (5/16 in.). Use a separate fuel hose/fuel tank pickup for each engine.

### FUEL HOSE CONNECTION

Fasten the remote fuel hose to the fitting with a metal hose clamp or the plastic type hose clamp that is provided with the outboard.

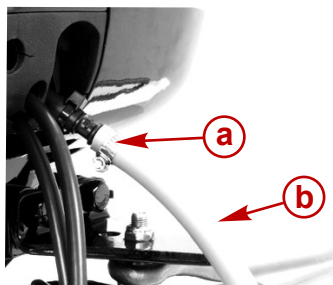

28511

- a** - Hose clamp
- b** - Remote fuel hose



# OUTBOARD INSTALLATION

## Electrical Connections and Control Cable Installation

### REMOTE WIRING HARNESS

Remove the access cover.

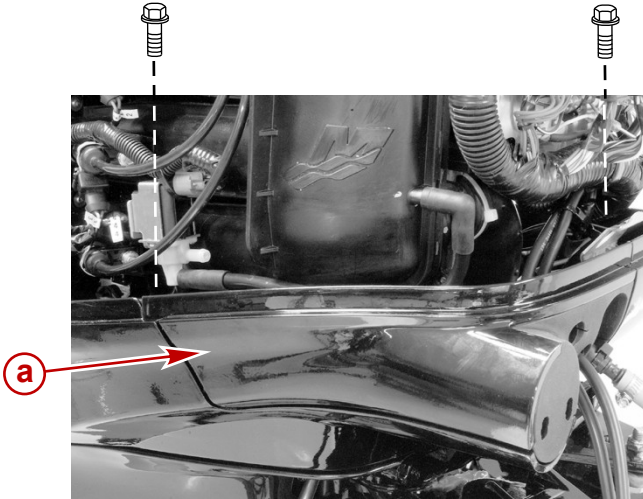

28505

**a** - Access cover

Route the remote wiring harness through the rubber grommet.

# OUTBOARD INSTALLATION

Connect the 14 pin connector to the engine harness and fasten the harness with the retainer.

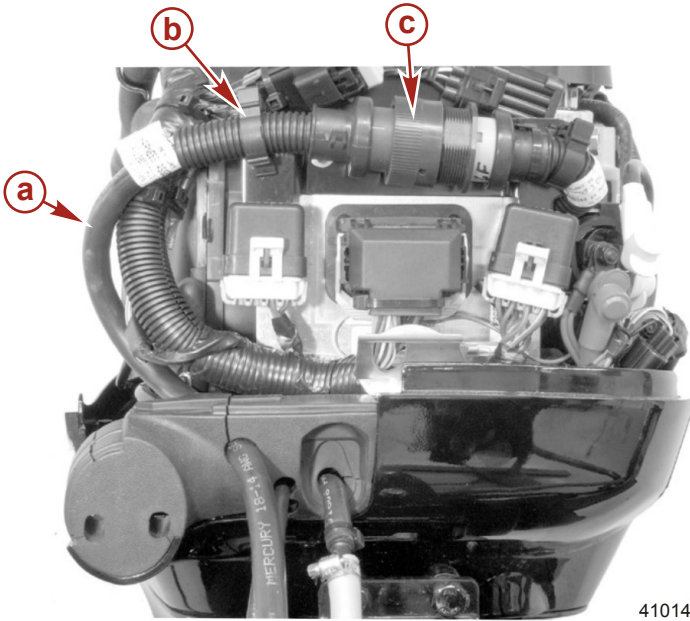

41014

- a** - Remote wiring harness
- b** - Retainer
- c** - 14 pin connector

## BATTERY CABLE CONNECTIONS

Single Outboard

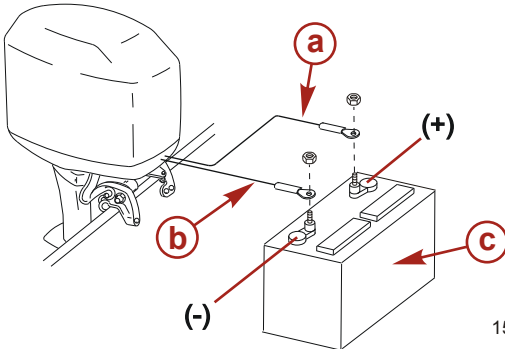

- a** - Red sleeve - Positive (+)
- b** - Black sleeve - Negative (-)
- c** - Cranking battery

15496

# OUTBOARD INSTALLATION

## Dual Outboards

Connect a common ground cable (wire size same as engine battery cables) between negative (-) terminals on starting batteries.

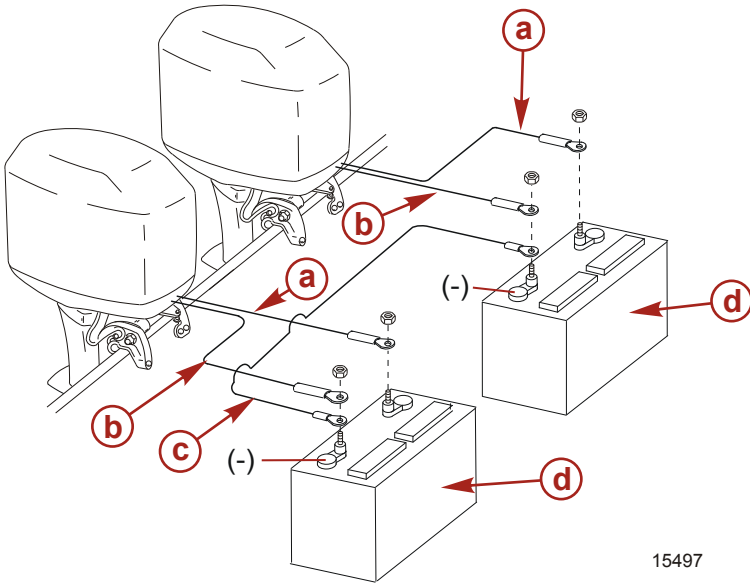

- a** - Red sleeve - Positive (+)
- b** - Black sleeve - Negative (-)
- c** - Ground cable
- d** - Cranking battery

## SHIFT CABLE INSTALLATION

Install the cables into the remote control following the instructions provided with the remote control.

1. Locate the center point of the slack or lost motion that exists in the shift cable as follows:
  - a. Move the remote control handle from neutral into forward and advance the handle to full speed position. Slowly return the handle back to neutral. Place a mark ("a") on the cable next to the cable end guide.

# OUTBOARD INSTALLATION

- b. Move the remote control handle from neutral into reverse and advance the handle to full speed position. Slowly return the handle back to neutral. Place a mark ("b") on the cable next to the cable end guide.
- c. Make a center mark ("c"), midway between marks ("a" and "b"). Align the cable end guide with this center mark when installing cable to the engine.

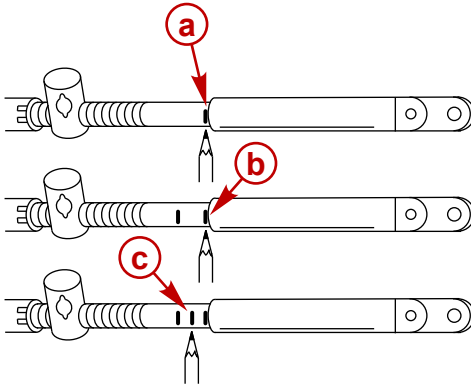

6098

2. Manually shift the outboard into neutral. The propeller will rotate freely.
3. Position the remote control handle into neutral.

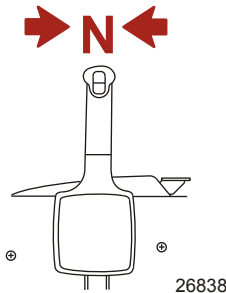

26838

# OUTBOARD INSTALLATION

4. Fit the shift cable through the rubber grommet.

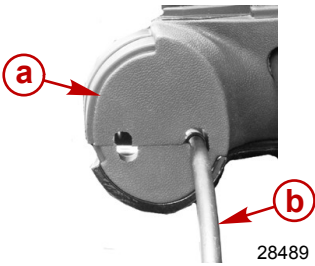

- a** - Rubber grommet
- b** - Shift cable

5. Attach the shift cable to the shift lever with a bow tie clip retainer.
6. Adjust the cable barrel so the center mark on the cable is aligned with the end guide when the cable barrel is placed in the barrel receptacle.

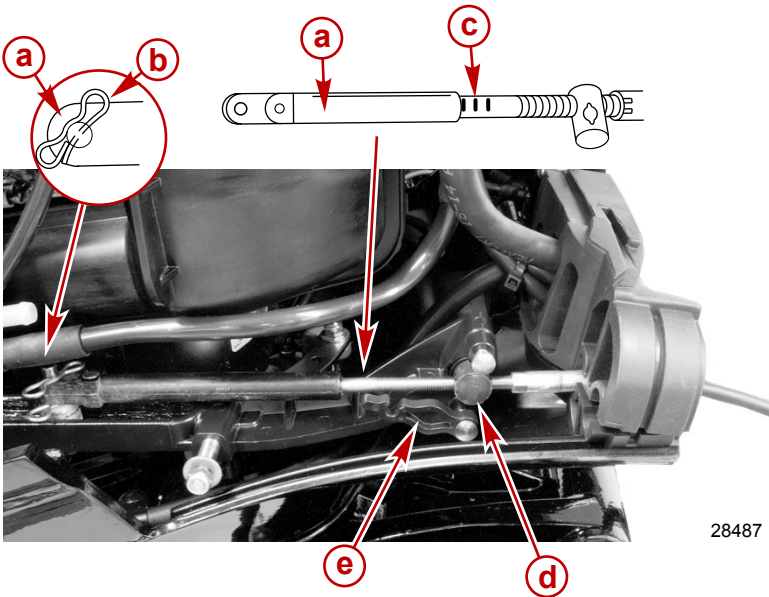

- a** - Cable end guide
- b** - Bow tie clip retainer
- c** - Center mark
- d** - Cable barrel
- e** - Barrel latch

# OUTBOARD INSTALLATION

7. Place the cable barrel into the barrel receptacle.
8. Lock barrel in place with the barrel latch.

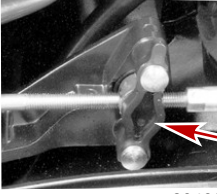

**a** - Barrel latch

9. Check shift cable adjustments as follows:
  - a. Shift remote control into forward. The propeller shaft should be locked in gear. If not, adjust the barrel closer to the cable end guide.
  - b. Shift remote control into reverse while turning propeller. The propeller shaft should be locked in gear. If not, adjust the barrel away from the cable end guide. Repeat steps a through c.
  - c. Shift remote control back to neutral. The propeller shaft should turn freely without drag. If not, adjust the barrel closer to the cable end guide. Repeat steps a through c.

## THROTTLE CABLE INSTALLATION

Install the cables into the remote control following the instructions provided with the remote control.

1. Position the remote control into neutral.

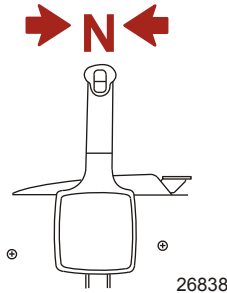

## OUTBOARD INSTALLATION

2. Fit the throttle cable through the rubber grommet.

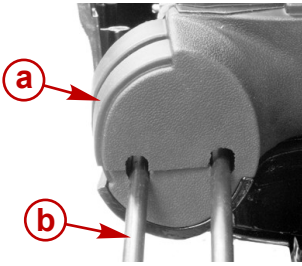

- a** - Rubber grommet
- b** - Throttle cable

28491

3. Attach the throttle cable to the throttle lever with a bow tie clip retainer.
4. Adjust cable barrel until the barrel slips onto the mounting stud.

# OUTBOARD INSTALLATION

5. Fasten the throttle cable to the mounting stud with a flat washer and locknut. Tighten the locknut to the specified torque.

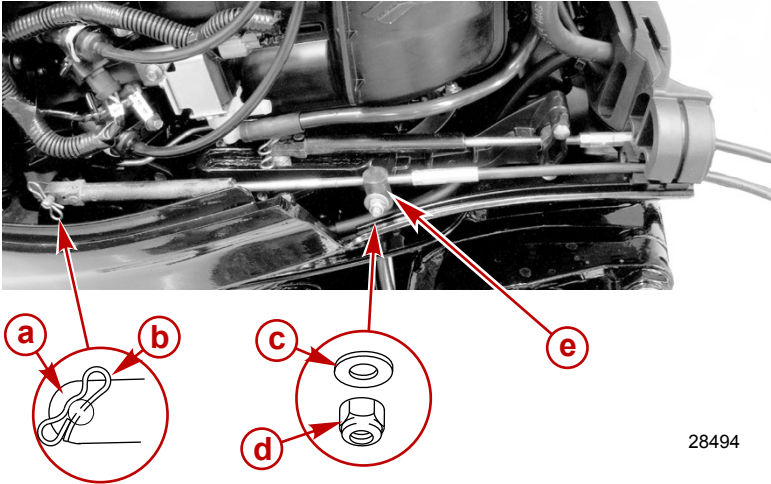

28494

- a** - Cable end guide
- b** - Bow tie clip retainer
- c** - Flat washer
- d** - Locknut
- e** - Cable barrel

Description	Nm	lb-in.	lb-ft
Throttle cable locknut	6	53	



# OUTBOARD INSTALLATION

6. Install the access cover with two bolts. Tighten the bolts to the specified torque.

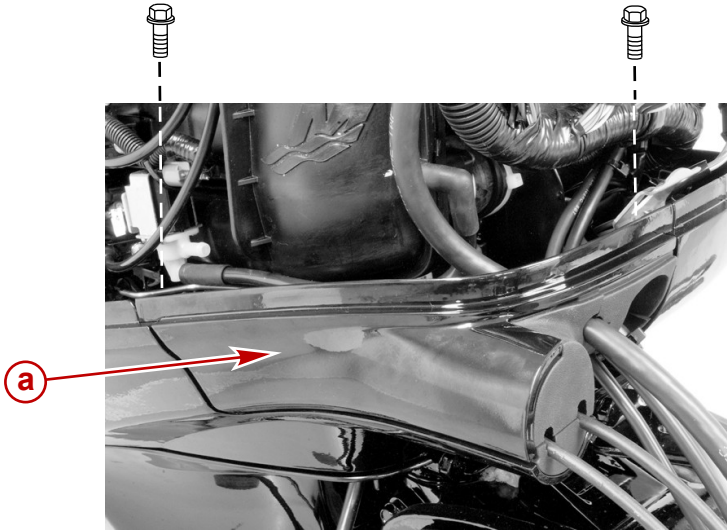

**a** - Access cover

Description	Nm	lb-in.	lb-ft
Access cover bolt	10	89	

## Propeller Installation

### PROPELLER INSTALLATION - 108 MM (4-1/4 IN.) DIAMETER GEARCASE

#### **⚠ WARNING**

Rotating propellers can cause serious injury or death. Never operate the boat out of the water with a propeller installed. Before installing or removing a propeller, place the drive unit in neutral and engage the lanyard stop switch to prevent the engine from starting. Place a block of wood between the propeller blade and the anti-ventilation plate.

# OUTBOARD INSTALLATION

1. Coat the propeller shaft with Quicksilver or Mercury Precision Lubricants Anti-Corrosion Grease or 2-4-C Marine Lubricant with Teflon.

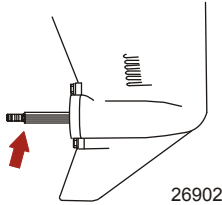

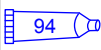
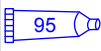
Tube Ref No.	Description	Where Used	Part No.
 94	Anti-Corrosion Grease	Propeller shaft	92-802867Q 1
 95	2-4-C Marine Lubricant with Teflon	Propeller shaft	92-802859A 1

**IMPORTANT:** To prevent the propeller hub from corroding and seizing to the propeller shaft (especially in saltwater), always apply a coat of the recommended lubricant to the entire propeller shaft at the recommended maintenance intervals, and also each time the propeller is removed.

2. Flo-Torq I drive hub propellers - Install thrust washer, propeller, continuity washer, thrust hub, propeller nut retainer, and propeller nut onto the shaft.

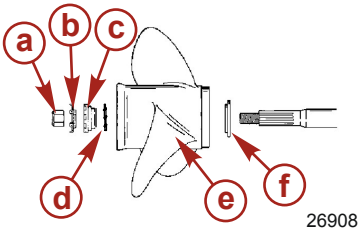

- a** - Propeller nut
- b** - Propeller nut retainer
- c** - Thrust hub
- d** - Continuity washer
- e** - Propeller
- f** - Thrust washer

# OUTBOARD INSTALLATION

3. Flo-Torq II drive hub propellers - Install forward thrust hub, replaceable drive sleeve, propeller, thrust hub, propeller nut retainer, and propeller nut onto the shaft.

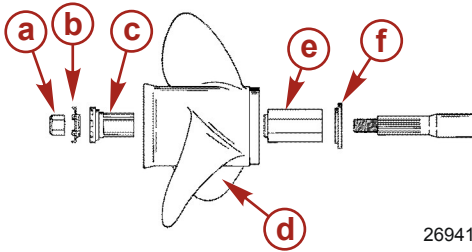

26941

- a** - Propeller nut
- b** - Propeller nut retainer
- c** - Thrust hub
- d** - Propeller
- e** - Replaceable drive sleeve
- f** - Forward thrust hub

**NOTE:** *Stainless steel applications - Installation of a Flo-Torq III drive hub propeller is recommended.*

4. Flo-Torq III drive hub propellers - Install forward thrust hub, replaceable drive sleeve, propeller, rear thrust hub, propeller nut retainer, and propeller nut onto the shaft.

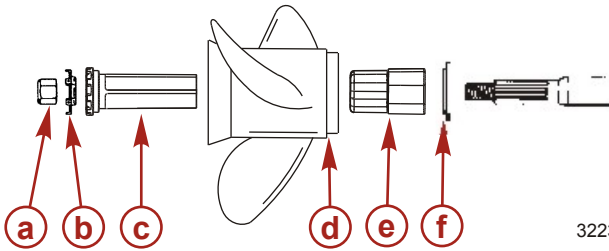

3223

- a** - Propeller nut
- b** - Propeller nut retainer
- c** - Rear thrust hub
- d** - Propeller
- e** - Replaceable drive sleeve
- f** - Forward thrust hub

5. Place a block of wood between gearcase and propeller and torque propeller nut to specifications.

Description	Nm	lb. in.	lb. ft.
Propeller nut	75		55

## OUTBOARD INSTALLATION

- Secure propeller nut by bending three of the tabs into the thrust hub grooves.

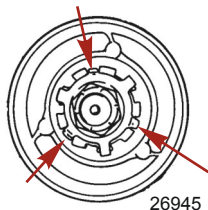



### PROPELLER INSTALLATION - 87.3 MM (3-7/16 IN.) DIAMETER GEARCASE

#### **⚠ WARNING**

Rotating propellers can cause serious injury or death. Never operate the boat out of the water with a propeller installed. Before installing or removing a propeller, place the drive unit in neutral and engage the lanyard stop switch to prevent the engine from starting. Place a block of wood between the propeller blade and the anti-ventilation plate.

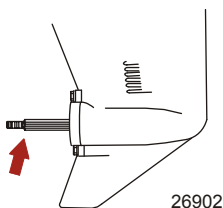
- Coat the propeller shaft with Quicksilver or Mercury Precision Lubricants Anti-Corrosion Grease or 2-4-C Marine Lubricant with Teflon.



Tube Ref No.	Description	Where Used	Part No.
 94	Anti-Corrosion Grease	Propeller shaft	92-802867Q 1
 95	2-4-C Marine Lubricant with Teflon	Propeller shaft	92-802859A 1

# OUTBOARD INSTALLATION

**IMPORTANT:** To prevent the propeller hub from corroding and seizing to the propeller shaft (especially in saltwater), always apply a coat of the recommended lubricant to the entire propeller shaft at the recommended maintenance intervals, and also each time the propeller is removed.

- Flo-Torq I drive hub propellers - Install forward thrust hub, propeller, propeller nut retainer, and propeller nut onto the shaft.

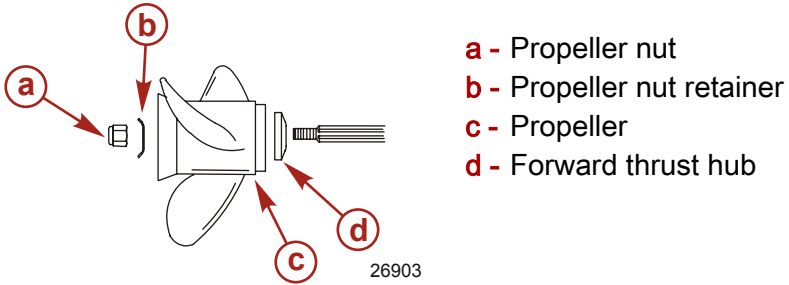

- Flo-Torq II drive hub propellers - Install forward thrust hub, propeller, replaceable drive sleeve, rear thrust hub, propeller nut retainer, and propeller nut onto the shaft.

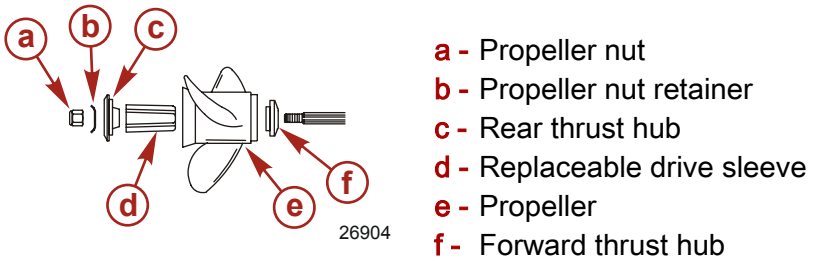

- Place propeller nut retainer over pins. Place a block of wood between gearcase and propeller and tighten propeller nut to specifications.

Description	Nm	lb. in.	lb. ft.
Propeller nut	75		55

## OUTBOARD INSTALLATION

- Align flat sides of the propeller nut with tabs on the propeller nut retainer. Secure propeller nut by bending tabs up and against the flats on the propeller nut.

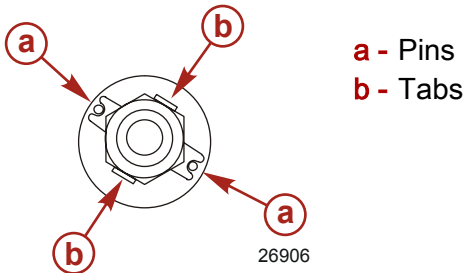

- Reinstall spark plug leads.

### Trim Tab Adjustment

Propeller steering torque will cause your boat to pull in one direction. This steering torque is a normal thing that results from your outboard not being trimmed so the propeller shaft is parallel to the water surface. The trim tab can help compensate for this steering torque in many cases and can be adjusted within limits to reduce any unequal steering effort.

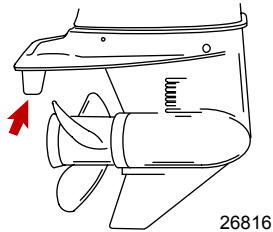

**NOTE:** Trim tab adjustment will have little effect reducing steering torque if the outboard is installed with the anti-ventilation plate approximately 50 mm (2 inches) or more above the boat bottom.

Operate your boat at normal cruising speed, trimmed to the desired position. Turn your boat left and right and note the direction the boat turns more easily.

# OUTBOARD INSTALLATION

If adjustment is necessary, loosen trim tab bolt and make small adjustments at a time. If the boat turns more easily to the left, move the trailing edge of trim tab to the left. If the boat turns more easily to the right, move the trailing edge of trim tab to the right. Retighten bolt and retest.

## Trim-In Stop Adjustment - Power Trim Models

If an adjustment is required to the trim-in stop, reposition the tilt stop pins in the desired holes. Tighten the tilt stop pins to the specified torque.

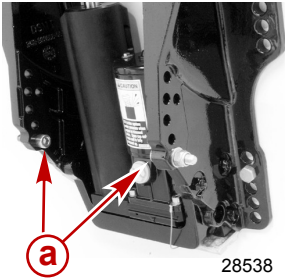

**a** - Tilt stop pins

Description	Nm	lb-in.	lb-ft
Tilt stop pins	24.4		18

# MAINTENANCE LOG

## Maintenance Log

Record all maintenance performed on your outboard here. Be sure to save all work orders and receipts.

Date	Maintenance Performed	Engine Hours