

## Thank You

for your purchase of one of the finest outboards available. You have made a sound investment in boating pleasure. Your outboard has been manufactured by Mercury Marine, a world leader in marine technology and outboard manufacturing since 1939. These years of experience have been committed to the goal of producing the finest quality products. This led to Mercury Marine's reputation for strict quality control, excellence, durability, lasting performance, and being the best at providing after the sale support.

Please read this manual carefully before operating your outboard. This manual has been prepared to assist you in the operation, safe use, and care of your outboard.

All of us at Mercury Marine took pride in building your outboard and wish you many years of happy and safe boating.

Again, thank you for your confidence in Mercury Marine.

## EPA Emissions Regulations

Outboards sold by Mercury Marine in the United States are certified to the United States Environmental Protection Agency as conforming to the requirements of the regulations for the control of air pollution from new outboard motors. This certification is contingent on certain adjustments being set to factory standards. For this reason, the factory procedure for servicing the product must be strictly followed and, wherever practicable, returned to the original intent of the design. **Maintenance, replacement, or repair of the emission control devices and systems may be performed by any marine engine repair establishment or individual.**

Engines are labeled with an Emission Control Information decal as permanent evidence of EPA certification.

### WARNING

The engine exhaust from this product contains chemicals known to the state of California to cause cancer, birth defects or other reproductive harm.

## Warranty Message

The product you have purchased comes with a **limited warranty** from Mercury Marine, the terms of the warranty are set forth in the **Warranty Information** section of this manual. The warranty statement contains a description of what is covered, what is not covered, the duration of coverage, how to best obtain warranty coverage, **important disclaimers and limitations of damages**, and other related information. Please review this important information.

The description and specifications contained herein were in effect at the time this manual was approved for printing. Mercury Marine, whose policy is one of continued improvement, reserves the right to discontinue models at any time, to change specifications, designs, methods, or procedures without notice and without incurring obligation.

Mercury Marine, Fond du Lac, Wisconsin U.S.A.

Litho in U.S.A.

© 2011, Mercury Marine

Mercury, Mercury Marine, MerCruiser, Mercury MerCruiser, Mercury Racing, Mercury Precision Parts, Mercury Propellers, Mariner, Quicksilver, #1 On The Water, Alpha, Bravo, Pro Max, OptiMax, Sport-Jet, K-Planes, MerCathode, RideGuide, SmartCraft, Zero Effort, M with Waves logo, Mercury with Waves logo, and SmartCraft logo are all registered trademarks of Brunswick Corporation. Mercury Product Protection logo is a registered service mark of Brunswick Corporation.

## Mercury Premier Service

Mercury evaluates the service performance of its dealers and assigns its highest rating of "Mercury Premier" to those demonstrating an exceptional commitment to service.

### **Earning a Mercury Premier Service rating means a dealer:**

- Achieves a high 12 month service CSI (Customer Satisfaction Index) score for warranty service.
- Possesses all necessary service tools, test equipment, manuals, and parts books.
- Employs at least one Certified or Master technician.

- Provides timely service for all Mercury Marine customers.
- Offers extended service hours and mobile service, when appropriate.
- Uses, displays, and stocks adequate inventory of genuine Mercury Precision Parts.
- Offers a clean, neat shop with well organized tools and service literature.

**Declaration of Conformity - For Recreational Craft Propulsion Engines with the Requirements of Directive 94/25/EC as amended by 2003/44/EC**

<b>Name of engine manufacturer:</b> Tohatsu Marine Corporation (TMC) Mercury Marine Joint Venture			
<b>Address:</b> Shimodaira 4495-9			
<b>Town:</b> Komagane-City, Nagano	<b>Post Code:</b> 399-4101	<b>Country:</b> Japan	

<b>Name of Authorized Representative:</b> Brunswick Marine in EMEA Inc.			
<b>Address:</b> Parc Industriel de Petit-Rechain			
<b>Town:</b> Verviers	<b>Post Code:</b> B-2800	<b>Country:</b> Belgium	

<b>Name of Notified Body for exhaust emission assessment:</b> TUV SUD Group			
<b>Address:</b> Ridlerstrasse 65			
<b>Town:</b> Munich	<b>Post Code:</b> 80339	<b>Country:</b> Germany	<b>ID Number:</b> 0123

<b>Name of Notified Body for noise emission assessment:</b> International Marine Certification Institute			
<b>Address:</b> Rue Abbe Cuypers 3			
<b>Town:</b> Bruxelles	<b>Post Code:</b> B-1040	<b>Country:</b> Belgium	<b>ID Number:</b> 0609

<b>Conformity assessment module used for exhaust emissions:</b>	<input checked="" type="checkbox"/> B +C	<input type="checkbox"/> B +D	<input type="checkbox"/> B +E	<input type="checkbox"/> B +F	<input type="checkbox"/> G	<input type="checkbox"/> H
<b>or engine type approved according to:</b>	<input type="checkbox"/> Stage II of Directive 97/68/EC			<input type="checkbox"/> Directive 88/77/EC		
<b>Conformity assessment module used for noise emissions:</b>	<input type="checkbox"/> A	<input checked="" type="checkbox"/> Aa	<input type="checkbox"/> G	<input type="checkbox"/> H		
<b>Other Community Directives applied: Safety of Machinery Directive 98/37/EC; Electromagnetic Compatibility Directive 2004/108/EC</b>						

### Description of Engines and Essential Requirements

<b>Engine Type</b>	<b>Fuel Type</b>	<b>Combustion Cycle</b>
<input type="checkbox"/> z or sterndrive without integral exhaust	<input type="checkbox"/> Diesel	<input type="checkbox"/> 2 stroke
<input checked="" type="checkbox"/> Outboard engine	<input checked="" type="checkbox"/> Petrol	<input checked="" type="checkbox"/> 4 stroke

### Identification of Engines Covered by This Declaration of Conformity

Name of engine family	Unique engine identification number: starting serial number	EC Type-examination certificate or type-approval certificate number
15, 20 hp	0R335220	SB5 07 12 57840 027
25, 30 hp EFI	0R336045	SB5 05 10 57840 003



Essential requirements	Standards	Other normative document/ method	Technical file	Please specify in more detail (* = mandatory standard)
<b>Annex 1.B—Exhaust Emissions</b>				
B.1 engine identification	<input type="checkbox"/>	<input type="checkbox"/>	<input checked="" type="checkbox"/>	
B.2 exhaust emission requirements	<input checked="" type="checkbox"/> *	<input type="checkbox"/>	<input type="checkbox"/>	* EN ISO 8178-1:1996
B.3 durability	<input type="checkbox"/>	<input type="checkbox"/>	<input checked="" type="checkbox"/>	
B.4 owner's manual	<input checked="" type="checkbox"/>	<input type="checkbox"/>	<input type="checkbox"/>	ISO 8665: 1995
<b>Annex 1.C—Noise Emissions</b>				
C.1 Noise emission levels	<input checked="" type="checkbox"/> *	<input type="checkbox"/>	<input type="checkbox"/>	EN ISO 14509
C.2 Owner's manual	<input type="checkbox"/>	<input checked="" type="checkbox"/>	<input type="checkbox"/>	Owner's manual

This declaration of conformity is issued under the sole responsibility of the manufacturer. I declare on behalf of the engine manufacturer that the engines mentioned preceding complies with all applicable essential requirements in the way specified.

**Name / function:**

Mark D. Schwabero, President,  
Mercury Outboard



**Date and place of issue:**

July 24, 2008  
Fond du Lac, Wisconsin, USA



---

## WARRANTY INFORMATION

---

Warranty Registration.....	1
Transfer of Warranty.....	2
FourStroke Outboard Limited Warranty.....	2
FourStroke Outboard Limited Warranty.....	6
FourStroke Outboard Limited Warranty.....	10
3 Year Limited Warranty Against Corrosion.....	14
Warranty Coverage and Exclusions.....	17

---

## GENERAL INFORMATION

---

Boater's Responsibilities.....	20
Before Operating Your Outboard.....	20
Boat Horsepower Capacity.....	21
High-Speed and High-Performance Boat Operation.....	21
Propeller Selection.....	22
Outboard Remote Control Models .....	25
Remote Steering Notice.....	25
Lanyard Stop Switch.....	26
Protecting People in the Water.....	30
Passenger Safety Message - Pontoon Boats and Deck Boats .....	31
Wave and Wake Jumping.....	32
Impact with Underwater Hazards.....	33
Safety Instructions for Hand-Tilled Outboards.....	34
Exhaust Emissions.....	35
Selecting Accessories for Your Outboard.....	37
Safe Boating Suggestions.....	38
Recording Serial Number.....	40
Specifications.....	40
Component Identification.....	42

---

## TRANSPORTING

---

Trailing Boat/Outboard .....	48
Transporting Your Outboard When Removed From Boat.....	48
Transporting Portable Fuel Tanks.....	49

---

## FUEL and OIL

---

Fuel Recommendations.....	51
Low Permeation Fuel Hose Requirement .....	53
Filling Fuel Tank.....	53
Engine Oil Recommendations.....	54
Checking And Adding Engine Oil.....	54

---

## FEATURES and CONTROLS

---

Remote Control Features.....	57
Tiller Handle Model Features.....	58
Warning System.....	62
Tiller Handle Models with Manual Gas Assist Tilt.....	64
Tiller Handle Models with Manual Tilt.....	69
Power Trim and Tilt (if Equipped).....	74
Trim Tab Adjustment.....	79

---

## OPERATION

---

Prestarting Check List.....	81
Operating in Freezing Temperatures.....	81
Operating in Saltwater or Polluted Water.....	82
Pre-Starting Instructions.....	82
Engine Break-in Procedure.....	83
Starting the Engine - Remote Control Models.....	83
Starting the Engine - Tiller Handle Models.....	86
Gear Shifting .....	89
Stopping the Engine .....	90
Emergency Starting.....	90

---

## MAINTENANCE

---

Outboard Care.....	93
EPA Emissions.....	94
Inspection and Maintenance Schedule.....	95
Flushing the Cooling System.....	96
Top Cowl Removal and Installation.....	99
Exterior Care.....	99
Battery Inspection .....	100
Fuel System.....	100
Steering Link Rod Fasteners.....	102
Corrosion Control Anode.....	103
Propeller Replacement.....	105
Spark Plug Inspection and Replacement.....	108
Fuse Replacement - Electric Start Models.....	109
Timing Belt Inspection.....	110
Lubrication Points.....	111
Checking Power Trim Fluid.....	114
Changing Engine Oil .....	114
Gearcase Lubrication.....	116
Submerged Outboard.....	118

---

## STORAGE

---

Storage Preparation.....	119
Protecting External Outboard Components.....	120
Protecting Internal Engine Components.....	120
Gearcase.....	120
Positioning Outboard for Storage.....	120
Battery Storage.....	121

---

## TROUBLESHOOTING

---

Starter Motor Will Not Crank the Engine (Electric Start Models)	122
.....	122
Engine Will Not Start.....	122
Engine Runs Erratically.....	123
Performance Loss.....	123
Battery Will Not Hold Charge.....	123

---

## OWNER SERVICE ASSISTANCE

---

Local Repair Service.....	125
Service Away from Home.....	125
Parts and Accessories Inquiries.....	125
Service Assistance.....	125
Mercury Marine Service Offices.....	126

---

## INSTALLATION

---

Installation Information.....	128
Installing Outboard.....	130
Electrical Harness, Battery Connection, Fuel Tanks.....	140
Control Cable Installation.....	145
Installing Propeller.....	149

# WARRANTY INFORMATION

## Warranty Registration

### UNITED STATES AND CANADA

To be eligible for warranty coverage, the product must be registered with Mercury Marine.

At the time of sale, the selling dealer should complete the warranty registration and immediately submit it to Mercury Marine via MercNET, e-mail, or mail. Upon receipt of this warranty registration, Mercury Marine will record the registration.

A copy of the warranty registration should be provided to you by your selling dealer.

***NOTE:*** *Registration lists must be maintained by Mercury Marine and any dealer on marine products sold in the United States, should a safety recall notification under the Federal Safety Act be required.*

You may change your address at any time, including at time of warranty claim, by calling Mercury Marine or sending a letter or fax with your name, old address, new address, and engine serial number to Mercury Marine's warranty registration department.

Your dealer can also process this change of information.

Mercury Marine

Attn: Warranty Registration Department

W6250 W. Pioneer Road

P.O. Box 1939

Fond du Lac, WI 54936-1939

920-929-5054

Fax +1 920 929 5893

### OUTSIDE UNITED STATES AND CANADA

For products purchased outside the United States and Canada, contact the distributor in your country, or the Marine Power Service Center closest to you.

# WARRANTY INFORMATION

## Transfer of Warranty

### UNITED STATES AND CANADA

The limited warranty is transferable to a subsequent purchaser, but only for the remainder of the unused portion of the limited warranty. This will not apply to products used for commercial applications.

To transfer the warranty to the subsequent owner, send or fax a copy of the bill of sale or purchase agreement, new owner's name, address, and engine serial number to Mercury Marine's warranty registration department. In the United States and Canada, mail to:

Mercury Marine  
Attn: Warranty Registration Department  
W6250 W. Pioneer Road  
P.O. Box 1939  
Fond du Lac, WI 54936-1939  
920-929-5054  
Fax +1 920 929 5893

Upon processing the transfer of warranty, Mercury Marine will record the new owner's information.

There is no charge for this service.

### OUTSIDE THE UNITED STATES AND CANADA

For products purchased outside the United States and Canada, contact the distributor in your country, or the Marine Power Service Center closest to you.

## FourStroke Outboard Limited Warranty

### UNITED STATES AND CANADA

*Outside the United States and Canada - Check with your local distributor.*

**WHAT IS COVERED:** Mercury Marine warrants its new products to be free of defects in material and workmanship during the period described below.



# WARRANTY INFORMATION

**DURATION OF COVERAGE:** This Limited Warranty provides coverage for three (3) years from the date the product is first sold to a recreational use retail purchaser, or the date on which the product is first put into service, whichever occurs first.

Commercial users of these products receive warranty coverage of one (1) year from the date of first retail sale, or one (1) year from the date on which the product was first put into service, whichever occurs first. Commercial use is defined as any work or employment related use of the product, or any use of the product which generates income, for any part of the warranty period, even if the product is only occasionally used for such purposes.

The repair or replacement of parts, or the performance of service under this warranty, does not extend the life of this warranty beyond its original expiration date. Unexpired warranty coverage can be transferred from one recreational use customer to a subsequent recreational use customer upon proper reregistration of the product. Unexpired warranty coverage cannot be transferred either to or from a commercial use customer.

Warranty coverage may be terminated for used repossessed product; or product purchased at auction, from a salvage yard, or from an insurance company.

**CONDITIONS THAT MUST BE MET IN ORDER TO OBTAIN WARRANTY COVERAGE:** Warranty coverage is available only to retail customers that purchase from a Dealer authorized by Mercury Marine to distribute the product in the country in which the sale occurred, and then only after the Mercury Marine specified predelivery inspection process is completed and documented. Warranty coverage becomes available upon proper registration of the product by the authorized dealer. Inaccurate warranty registration information regarding recreational use, or subsequent change of use from recreational to commercial (unless properly reregistered) may void the warranty at the sole discretion of Mercury Marine. Routine maintenance outlined in the Operation and Maintenance Manual must be timely performed in order to maintain warranty coverage. Mercury Marine reserves the right to make warranty coverage contingent upon proof of proper maintenance.

# WARRANTY INFORMATION

**WHAT MERCURY WILL DO:** Mercury's sole and exclusive obligation under this warranty is limited to, at our option, repairing a defective part, replacing such part or parts with new or Mercury Marine certified remanufactured parts, or refunding the purchase price of the Mercury product. Mercury reserves the right to improve or modify products from time to time without assuming an obligation to modify products previously manufactured.

**HOW TO OBTAIN WARRANTY COVERAGE:** The customer must provide Mercury with a reasonable opportunity to repair, and reasonable access to the product for warranty service. Warranty claims shall be made by delivering the product for inspection to a Mercury dealer authorized to service the product. If purchaser cannot deliver the product to such a dealer, written notice must be given to Mercury. We will then arrange for the inspection and any covered repair. Purchaser, in that case, shall pay for all related transportation charges and/or travel time. If the service provided is not covered by this warranty, purchaser shall pay for all related labor and material, and any other expenses associated with that service. Purchaser shall not, unless requested by Mercury, ship the product or parts of the product directly to Mercury. Proof of registered ownership must be presented to the dealer at the time warranty service is requested in order to obtain coverage.

# WARRANTY INFORMATION

**WHAT IS NOT COVERED:** This limited warranty does not cover routine maintenance items, tune-ups, adjustments, normal wear and tear, damage caused by abuse, abnormal use, use of a propeller or gear ratio that does not allow the engine to run in its recommended wide-open throttle RPM range (see the Operation and Maintenance Manual), operation of the product in a manner inconsistent with the recommended operation/duty cycle section of the Operation and Maintenance Manual, neglect, accident, submersion, improper installation (proper installation specifications and techniques are set forth in the installation instructions for the product), improper service, use of an accessory or part not manufactured or sold by us, jet pump impellers and liners, operation with fuels, oils, or lubricants which are not suitable for use with the product (see the Operation and Maintenance Manual), alteration or removal of parts, water entering the engine through the fuel intake, air intake or exhaust system, or damage to the product from insufficient cooling water caused by blockage of the cooling system by a foreign body, running the engine out of water, mounting the engine too high on the transom, or running the boat with the engine trimmed out too far. Use of the product for racing or other competitive activity, or operating with a racing type lower unit, at any point, even by a prior owner of the product, voids the warranty.

Expenses related to haul-out, launch, towing, storage, telephone, rental, inconvenience, slip fees, insurance coverage, loan payments, loss of time, loss of income, or any other type of incidental or consequential damages are not covered by this warranty. Also, expenses associated with the removal and/or replacement of boat partitions or material caused by boat design for access to the product are not covered by this warranty.

No individual or entity, including Mercury Marine authorized dealers, has been given authority by Mercury Marine to make any affirmation, representation, or warranty regarding the product, other than those contained in this limited warranty, and if made, shall not be enforceable against Mercury Marine.

# WARRANTY INFORMATION

For additional information regarding events and circumstances covered by this warranty, and those that are not, see the Warranty Coverage section of the Operation and Maintenance Manual, incorporated by reference into this warranty.

## DISCLAIMERS AND LIMITATIONS:

THE IMPLIED WARRANTIES OF MERCHANTABILITY AND FITNESS FOR A PARTICULAR PURPOSE ARE EXPRESSLY DISCLAIMED. TO THE EXTENT THAT THEY CANNOT BE DISCLAIMED, THE IMPLIED WARRANTIES ARE LIMITED IN DURATION TO THE LIFE OF THE EXPRESS WARRANTY. INCIDENTAL AND CONSEQUENTIAL DAMAGES ARE EXCLUDED FROM COVERAGE UNDER THIS WARRANTY. SOME STATES/COUNTRIES DO NOT ALLOW FOR THE DISCLAIMERS, LIMITATIONS AND EXCLUSIONS IDENTIFIED ABOVE, AS A RESULT, THEY MAY NOT APPLY TO YOU. THIS WARRANTY GIVES YOU SPECIFIC LEGAL RIGHTS, AND YOU MAY ALSO HAVE OTHER LEGAL RIGHTS WHICH VARY FROM STATE TO STATE AND COUNTRY TO COUNTRY.

## FourStroke Outboard Limited Warranty

### EUROPE AND CONFEDERATION OF INDEPENDENT STATES

Outside Europe and Confederation of Independent States - check with local distributor.

**WHAT IS COVERED:** Mercury Marine warrants its new products to be free of defects in material and workmanship during the period described below.

# WARRANTY INFORMATION

**DURATION OF COVERAGE:** This Limited Warranty provides coverage for two (2) years from the date the product is first sold to a recreational use retail purchaser, or the date on which the product is first put into service, whichever occurs first.

Commercial users of these products receive warranty coverage of one (1) year from the date of first retail sale, or one (1) year from the date in which the product was first put into service, whichever occurs first. Commercial use is defined as any work or employment related use of the product, or any use of the product which generates income, for any part of the warranty period, even if the product is only occasionally used for such purposes.

The repair or replacement of parts, or the performance of service under this warranty, does not extend the life of this warranty beyond its original expiration date. Unexpired warranty coverage can be transferred from one recreational use customer to a subsequent recreational use customer upon proper reregistration of the product. Unexpired warranty coverage cannot be transferred either to or from a commercial use customer.

Warranty coverage may be terminated for used or repossessed product; or product purchased at auction, from a salvage yard, or from an insurance company.

**CONDITIONS THAT MUST BE MET IN ORDER TO OBTAIN WARRANTY COVERAGE:** Warranty coverage is available only to retail customers that purchase from a Dealer authorized by Mercury Marine to distribute the product in the country in which the sale occurred, and then only after the Mercury Marine specified predelivery inspection process is completed and documented. Warranty coverage becomes available upon proper registration of the product by the authorized dealer. Routine maintenance outlined in the Operation and Maintenance Manual must be timely performed in order to maintain warranty coverage. Mercury Marine reserves the right to make future warranty coverage contingent on proof of proper maintenance.

# WARRANTY INFORMATION

**WHAT MERCURY WILL DO:** Mercury's sole and exclusive obligation under this warranty is limited to, at our option, repairing a defective part, replacing such part or parts with new or Mercury Marine certified remanufactured parts, or refunding the purchase price of the Mercury product. Mercury reserves the right to improve or modify products from time to time without assuming an obligation to modify products previously manufactured.

**HOW TO OBTAIN WARRANTY COVERAGE:** The customer must provide Mercury with a reasonable opportunity to repair, and reasonable access to the product for warranty service. Warranty claims shall be made by delivering the product for inspection to a Mercury dealer authorized to service the product. If purchaser cannot deliver the product to such a dealer, written notice must be given to Mercury. We will then arrange for the inspection and any covered repair. Purchaser in that case shall pay for all related transportation charges and/or travel time. If the service provided is not covered by this warranty, purchaser shall pay for all related labor and material, and any other expenses associated with that service. Purchaser shall not, unless requested by Mercury, ship the product or parts of the product directly to Mercury. Proof of registered ownership must be presented to the dealer at the time warranty service is requested in order to obtain coverage.

# WARRANTY INFORMATION

**WHAT IS NOT COVERED:** This limited warranty does not cover routine maintenance items, tune-ups, adjustments, normal wear and tear, damage caused by abuse, abnormal use, use of a propeller or gear ratio that does not allow the engine to run in its recommended wide-open throttle RPM range (see the Operation and Maintenance Manual), operation of the product in a manner inconsistent with the recommended operation/duty cycle section of the Operation and Maintenance Manual, neglect, accident, submersion, improper installation (proper installation specifications and techniques are set forth in the installation instructions for the product), improper service, use of an accessory or part not manufactured or sold by us, jet pump impellers and liners, operation with fuels, oils or lubricants which are not suitable for use with the product (see the Operation and Maintenance Manual), alteration or removal of parts, or water entering the engine through the fuel intake, air intake or exhaust system, or damage to the product from insufficient cooling water caused by blockage of the cooling system by a foreign body, running the engine out of water, mounting the engine too high on the transom, or running the boat with the engine trimmed out too far. Use of the product for racing or other competitive activity, or operating with a racing type lower unit, at any point, even by a prior owner of the product, voids the warranty.

Expenses related to haul out, launch, towing, storage, telephone, rental, inconvenience, slip fees, insurance coverage, loan payments, loss of time, loss of income, or any other type of incidental or consequential damages are not covered by this warranty. Also, expenses associated with the removal and/or replacement of boat partitions or material caused by boat design for access to the product are not covered by this warranty.

No individual or entity, including Mercury Marine authorized dealers, has been given authority by Mercury Marine to make any affirmation, representation or warranty regarding the product, other than those contained in this limited warranty, and if made, shall not be enforceable against Mercury Marine.

# WARRANTY INFORMATION

For additional information regarding events and circumstances covered by this warranty, and those that are not, see the Warranty Coverage section of the Operation and Maintenance Manual, incorporated by reference into this warranty.

## DISCLAIMERS AND LIMITATIONS:

THE IMPLIED WARRANTIES OF MERCHANTABILITY AND FITNESS FOR A PARTICULAR PURPOSE ARE EXPRESSLY DISCLAIMED. TO THE EXTENT THAT THEY CANNOT BE DISCLAIMED, THE IMPLIED WARRANTIES ARE LIMITED IN DURATION TO THE LIFE OF THE EXPRESS WARRANTY. INCIDENTAL AND CONSEQUENTIAL DAMAGES ARE EXCLUDED FROM COVERAGE UNDER THIS WARRANTY. SOME STATES/COUNTRIES DO NOT ALLOW FOR THE DISCLAIMERS, LIMITATIONS AND EXCLUSIONS IDENTIFIED ABOVE, AS A RESULT, THEY MAY NOT APPLY TO YOU. THIS WARRANTY GIVES YOU SPECIFIC LEGAL RIGHTS, AND YOU MAY ALSO HAVE OTHER LEGAL RIGHTS WHICH VARY FROM STATE TO STATE AND COUNTRY TO COUNTRY.

## FourStroke Outboard Limited Warranty

### MIDDLE-EAST AND AFRICA

**WHAT IS COVERED:** Mercury Marine warrants its new Outboard and Jet Products to be free of defects in material and workmanship during the period described below.



# WARRANTY INFORMATION

**DURATION OF COVERAGE:** This Limited Warranty provides coverage for one (1) year from the date the product is first sold to a recreational use retail purchaser, or the date on which the product is first put into service, whichever occurs first.

Commercial users of these products receive warranty coverage of one (1) years from the date of first retail sale, or one (1) year from the date on which the product was first put into service, whichever occurs first. Commercial use is defined as any work or employment related use of the product, or any use of the product which generates income, for any part of the warranty period, even if the product is only occasionally used for such purposes. The repair or replacement of parts, or the performance of service under this warranty, does not extend the life of this warranty beyond its original expiration date. Unexpired warranty coverage can be transferred from one recreational use customer to a subsequent recreational use customer upon proper reregistration of the product. Unexpired warranty coverage cannot be transferred either to or from a commercial use customer.

**CONDITIONS THAT MUST BE MET IN ORDER TO OBTAIN WARRANTY COVERAGE:** Warranty coverage is available only to retail customers that purchase from a Dealer authorized by Mercury Marine to distribute the product in the country in which the sale occurred, and then only after the Mercury Marine specified predelivery inspection process is completed and documented. Warranty coverage becomes available upon proper registration of the product by the authorized dealer. Routine maintenance outlined in the Operation and Maintenance Manual must be timely performed in order to maintain warranty coverage. Mercury Marine reserves the right to make warranty coverage contingent on proof of proper maintenance.

**WHAT MERCURY WILL DO:** Mercury's sole and exclusive obligation under this warranty is limited to, at our option, repairing a defective part, replacing such part or parts with new or Mercury Marine certified remanufactured parts, or refunding the purchase price of the Mercury product. Mercury reserves the right to improve or modify products from time to time without assuming an obligation to modify products previously manufactured.

# WARRANTY INFORMATION

**HOW TO OBTAIN WARRANTY COVERAGE:** The customer must provide Mercury with a reasonable opportunity to repair, and reasonable access to the product for warranty service. Warranty claims shall be made by delivering the product for inspection to a Mercury dealer authorized to service the product. If purchaser cannot deliver the product to such a dealer, written notice must be given to Mercury. We will then arrange for the inspection and any covered repair. Purchaser in that case shall pay for all related transportation charges and/or travel time. If the service provided is not covered by this warranty, purchaser shall pay for all related labor and material, and any other expenses associated with that service. Purchaser shall not, unless requested by Mercury, ship the product or parts of the product directly to Mercury. Proof of registered ownership must be presented to the dealer at the time warranty service is requested in order to obtain coverage.

**WHAT IS NOT COVERED:** This limited warranty does not cover routine maintenance items, tune-ups, adjustments, normal wear and tear, damage caused by abuse, abnormal use, use of a propeller or gear ratio that does not allow the engine to run in its recommended wide-open throttle RPM range (see the Operation and Maintenance Manual), operation of the product in a manner inconsistent with the recommended operation/duty cycle section of the Operation and Maintenance Manual, neglect, accident, submersion, improper installation (proper installation specifications and techniques are set forth in the installation instructions for the product), improper service, use of an accessory or part not manufactured or sold by us, jet pump impellers and liners, operation with fuels, oils or lubricants which are not suitable for use with the product (see the Operation and Maintenance Manual), alteration or removal of parts, or water entering the engine through the fuel intake, air intake or exhaust system, or damage to the product from insufficient cooling water caused by blockage of the cooling system by foreign body, running the engine out of water, mounting the engine too high on the transom, or running the boat with the engine trimmed out too far.

# WARRANTY INFORMATION

Use of the product for racing or other competitive activity, or operating with a racing type lower unit, at any point, even by a prior owner of the product, voids the warranty.

Expenses related to haul out, launch, towing, storage, telephone, rental, inconvenience, slip fees, insurance coverage, loan payments, loss of time, loss of income, or any other type of incidental or consequential damages are not covered by this warranty. Also, expenses associated with the removal and/or replacement of boat partitions or material caused by boat design for access to the product are not covered by this warranty.

No individual or entity, including Mercury Marine authorized dealers, has been given authority by Mercury Marine to make any affirmation, representation or warranty regarding the product, other than those contained in this limited warranty, and if made, shall not be enforceable against Mercury Marine.

For additional information regarding events and circumstances covered by this warranty, and those that are not, see the Warranty Coverage section of the Operation and Maintenance Manual, incorporated by reference into this warranty.

## **DISCLAIMERS AND LIMITATIONS:**

**THE IMPLIED WARRANTIES OF MERCHANTABILITY AND FITNESS FOR A PARTICULAR PURPOSE ARE EXPRESSLY DISCLAIMED. TO THE EXTENT THAT THEY CANNOT BE DISCLAIMED, THE IMPLIED WARRANTIES ARE LIMITED IN DURATION TO THE LIFE OF THE EXPRESS WARRANTY. INCIDENTAL AND CONSEQUENTIAL DAMAGES ARE EXCLUDED FROM COVERAGE UNDER THIS WARRANTY. SOME STATES/COUNTRIES DO NOT ALLOW FOR THE DISCLAIMERS, LIMITATIONS AND EXCLUSIONS IDENTIFIED ABOVE, AS A RESULT, THEY MAY NOT APPLY TO YOU. THIS WARRANTY GIVES YOU SPECIFIC LEGAL RIGHTS, AND YOU MAY ALSO HAVE OTHER LEGAL RIGHTS WHICH VARY FROM STATE TO STATE AND COUNTRY TO COUNTRY.**

# WARRANTY INFORMATION

## 3 Year Limited Warranty Against Corrosion

**WHAT IS COVERED:** Mercury Marine warrants that each new Mercury, Mariner, Mercury Racing, Sport Jet, M<sup>2</sup> Jet Drive, Tracker by Mercury Marine Outboard, Mercury MerCruiser Inboard or Sterndrive Engine (Product) will not be rendered inoperative as a direct result of corrosion for the period of time described below.

**DURATION OF COVERAGE:** This limited corrosion warranty provides coverage for three (3) years from either the date the product is first sold, or the date on which the product is first put into service, whichever occurs first. The repair or replacement of parts, or the performance of service under this warranty, does not extend the life of this warranty beyond its original expiration date. Unexpired warranty coverage can be transferred to subsequent (noncommercial use) purchaser upon proper reregistration of the product.

**CONDITIONS THAT MUST BE MET IN ORDER TO OBTAIN WARRANTY COVERAGE:** Warranty coverage is available only to retail customers that purchase from a Dealer authorized by Mercury Marine to distribute the product in the country in which the sale occurred, and then only after the Mercury Marine specified predelivery inspection process is completed and documented. Warranty coverage becomes available upon proper registration of the product by the authorized dealer. Corrosion prevention devices specified in the Operation and Maintenance Manual must be in use on the boat, and routine maintenance outlined in the Operation and Maintenance Manual must be timely performed (including, without limitation, the replacement of sacrificial anodes, use of specified lubricants, and touch-up of nicks and scratches) in order to maintain warranty coverage. Mercury Marine reserves the right to make warranty coverage contingent upon proof of proper maintenance.

# WARRANTY INFORMATION

**WHAT MERCURY WILL DO:** Mercury's sole and exclusive obligation under this warranty is limited to, at our option, repairing a corroded part, replacing such part or parts with new or Mercury Marine certified remanufactured parts, or refunding the purchase price of the Mercury product. Mercury reserves the right to improve or modify products from time to time without assuming an obligation to modify products previously manufactured.

**HOW TO OBTAIN WARRANTY COVERAGE:** The customer must provide Mercury with a reasonable opportunity to repair, and reasonable access to the product for warranty service. Warranty claims shall be made by delivering the product for inspection to a Mercury dealer authorized to service the product. If purchaser cannot deliver the product to such a dealer, written notice must be given to Mercury. We will then arrange for the inspection and any covered repair. Purchaser, in that case, shall pay for all related transportation charges and/or travel time. If the service provided is not covered by this warranty, purchaser shall pay for all related labor and material, and any other expenses associated with that service. Purchaser shall not, unless requested by Mercury, ship the product or parts of the product directly to Mercury. Proof of registered ownership must be presented to the dealer at the time warranty service is requested in order to obtain coverage.

**WHAT IS NOT COVERED:** This limited warranty does not cover electrical system corrosion; corrosion resulting from damage, corrosion which causes purely cosmetic damage, abuse, or improper service; corrosion to accessories, instruments, steering systems; corrosion to factory installed jet drive unit; damage due to marine growth; product sold with less than a one year limited Product warranty; replacement parts (parts purchased by customer); products used in a commercial application. Commercial use is defined as any work or employment related use of the product, or any use of the product which generates income, for any part of the warranty period, even if the product is only occasionally used for such purposes.

## WARRANTY INFORMATION

Corrosion damage caused by stray electrical currents (onshore power connections, nearby boats, submerged metal) is not covered by this corrosion warranty and should be protected against by the use of a corrosion protection system, such as the Mercury Precision Parts or Quicksilver MerCathode system and/or Galvanic Isolator. Corrosion damage caused by improper application of copper base antifouling paints is also not covered by this limited warranty. If antifouling protection is required, Tri-Butyl-Tin-Adipate (TBTA) base antifouling paints are recommended on Outboard and MerCruiser boating applications. In areas where TBTA base paints are prohibited by law, copper base paints can be used on the hull and transom. Do not apply paint to the outboard or MerCruiser product. In addition, care must be taken to avoid an electrical interconnection between the warranted product and the paint. For MerCruiser product, an unpainted gap of at least 38 mm (1.5 in.) should be left around the transom assembly. Refer to the Operation and Maintenance Manual for additional details.

For additional information regarding events and circumstances covered by this warranty, and those that are not, see the Warranty Coverage section of the Operation and Maintenance Manual, incorporated by reference into this warranty.

### **DISCLAIMERS AND LIMITATIONS:**

**THE IMPLIED WARRANTIES OF MERCHANTABILITY AND FITNESS FOR A PARTICULAR PURPOSE ARE EXPRESSLY DISCLAIMED. TO THE EXTENT THAT THEY CANNOT BE DISCLAIMED, THE IMPLIED WARRANTIES ARE LIMITED IN DURATION TO THE LIFE OF THE EXPRESS WARRANTY. INCIDENTAL AND CONSEQUENTIAL DAMAGES ARE EXCLUDED FROM COVERAGE UNDER THIS WARRANTY. SOME STATES/COUNTRIES DO NOT ALLOW FOR THE DISCLAIMERS, LIMITATIONS AND EXCLUSIONS IDENTIFIED ABOVE, AS A RESULT, THEY MAY NOT APPLY TO YOU. THIS WARRANTY GIVES YOU SPECIFIC LEGAL RIGHTS, AND YOU MAY ALSO HAVE OTHER LEGAL RIGHTS WHICH VARY FROM STATE TO STATE AND COUNTRY TO COUNTRY.**

# WARRANTY INFORMATION

## Warranty Coverage and Exclusions

The purpose of this section is to help eliminate some of the more common misunderstandings regarding warranty coverage. The following information explains some of the types of services that are not covered by warranty. The provisions set forth following have been incorporated by reference into the Three Year Limited Warranty Against Corrosion Failure, the International Limited Outboard Warranty, and the United States and Canada Limited Outboard Warranty.

Keep in mind that warranty covers repairs that are needed within the warranty period because of defects in material and workmanship. Installation errors, accidents, normal wear, and a variety of other causes that affect the product are not covered.

Warranty is limited to defects in material or workmanship, but only when the consumer sale is made in the country to which distribution is authorized by us.

Should you have any questions concerning warranty coverage, contact your authorized dealer. They will be pleased to answer any questions that you may have.

## GENERAL EXCLUSIONS FROM WARRANTY

1. Minor adjustments and tune-ups, including checking, cleaning, or adjusting spark plugs, ignition components, carburetor settings, filters, belts, controls, and checking lubrication made in connection with normal services.
2. Factory installed jet drive units - Specific parts excluded from the warranty are: the jet drive impeller and jet drive liner damaged by impact or wear, and water damaged driveshaft bearings as a result of improper maintenance.
3. Damage caused by neglect, lack of maintenance, accident, abnormal operation, or improper installation or service.
4. Haul-out, launch, towing charges, removal and/or replacement of boat partitions or material because of boat design for necessary access to the product, all related transportation charges and/or travel time, etc. Reasonable access must be provided to the product for warranty service. Customer must deliver product to an authorized dealer.

# WARRANTY INFORMATION

5. Additional service work requested by customer other than that necessary to satisfy the warranty obligation.
6. Labor performed by other than an authorized dealer may be covered only under the following circumstances: when performed on emergency basis (providing there are no authorized dealers in the area who can perform the work required or have no facilities to haul-out, etc., and prior factory approval has been given to have the work performed at this facility).
7. All incidental and/or consequential damages (storage charges, telephone or rental charges of any type, inconvenience or loss of time or income) are the owner's responsibility.
8. Use of other than Mercury Precision or Quicksilver parts when making warranty repairs.
9. Oils, lubricants, or fluids changed as a matter of normal maintenance is customer's responsibility unless loss or contamination of same is caused by product failure that would be eligible for warranty consideration.
10. Participating in or preparing for racing or other competitive activity or operating with a racing type lower unit.
11. Engine noise does not necessarily indicate a serious engine problem. If diagnosis indicates a serious internal engine condition which could result in a failure, condition responsible for noise should be corrected under the warranty.
12. Lower unit and/or propeller damage caused by striking a submerged object is considered a marine hazard.
13. Water entering engine through the fuel intake, air intake, or exhaust system or submersion.
14. Failure of any parts caused by lack of cooling water, which results from starting motor out of water, foreign material blocking inlet holes, motor being mounted too high, or trimmed too far out.
15. Use of fuels and lubricants which are not suitable for use with or on the product. Refer to the **Maintenance** section.



## WARRANTY INFORMATION

16. Our limited warranty does not apply to any damage to our products caused by the installation or use of parts and accessories which are not manufactured or sold by us. Failures which are not related to the use of those parts or accessories are covered under warranty if they otherwise meet the terms of the limited warranty for that product.

# GENERAL INFORMATION

## Boater's Responsibilities

The operator (driver) is responsible for the correct and safe operation of the boat and safety of its occupants and general public. It is strongly recommended that each operator (driver) read and understand this entire manual before operating the outboard.

Be sure at least one additional person onboard is instructed in the basics of starting and operating the outboard and boat handling in case the driver is unable to operate the boat.

## Before Operating Your Outboard

Read this manual carefully. Learn how to operate your outboard properly. If you have any questions, contact your dealer.

Safety and operating information that is practiced, along with using good common sense, can help prevent personal injury and product damage.

This manual as well as safety labels posted on the outboard use the following safety alerts to draw your attention to special safety instructions that should be followed.

### **DANGER**

Indicates a hazardous situation which, if not avoided, will result in death or serious injury.

### **WARNING**

Indicates a hazardous situation which, if not avoided, could result in death or serious injury.

### **CAUTION**

Indicates a hazardous situation which, if not avoided, could result in minor or moderate injury.

### *NOTICE*

Indicates a situation which, if not avoided, could result in engine or major component failure.

# GENERAL INFORMATION

## Boat Horsepower Capacity

### WARNING

Exceeding the boat's maximum horsepower rating can cause serious injury or death. Overpowering the boat can affect boat control and flotation characteristics or break the transom. Do not install an engine that exceeds the boat's maximum power rating.

Do not overpower or overload your boat. Most boats will carry a required capacity plate indicating the maximum acceptable power and load as determined by the manufacturer following certain federal guidelines. If in doubt, contact your dealer or the boat manufacturer.

U.S. COAST GUARD CAPACITY	
MAXIMUM HORSEPOWER	XXX
MAXIMUM PERSON CAPACITY (POUNDS)	XXX
MAXIMUM WEIGHT CAPACITY	XXX

26777

## High-Speed and High-Performance Boat Operation

If your outboard is to be used on a high-speed or high-performance boat with which you are unfamiliar, we recommend that you never operate it at its high speed capability without first requesting an initial orientation and familiarization demonstration ride with your dealer or an operator experienced with your boat/outboard combination. For additional information, obtain a copy of our **Hi-Performance Boat Operation** booklet from your dealer, distributor, or Mercury Marine.

# GENERAL INFORMATION

## Propeller Selection

The propeller on your outboard is one of the most important components in the propulsion system. An improper propeller choice can significantly affect the performance of your boat and could result in damage to the outboard engine.

When choosing a propeller, a full selection of aluminum and stainless steel propellers specifically designed for your outboard are available through Mercury Marine. To view the entire product offering and find the correct propeller that is best suited for your application, visit [www.mercmarinepropellers.com](http://www.mercmarinepropellers.com) or see your local authorized Mercury dealer.

## SELECTING THE CORRECT PROPELLER

An accurate tachometer for measuring engine speed is important in choosing the correct propeller.

Choose a propeller for your boating application that will allow the engine to operate within the specified full throttle operating range. When operating the boat at full throttle under normal load conditions, the engine RPM should be in the upper half of the recommended full throttle RPM range. Refer to **Specifications**. If engine RPM is above that range, select a propeller of increased pitch in order to reduce engine RPM. If engine RPM is below the recommended range, select a propeller of reduced pitch to increase engine RPM.

**IMPORTANT: To ensure proper fit, and performance, Mercury Marine recommends the use of Mercury or Quicksilver branded propellers and mounting hardware.**

# GENERAL INFORMATION

Propellers are designated by the diameter, pitch, number of blades, and material. The diameter and pitch are stamped (cast) into the side or the end of the propeller hub. The first number represents the diameter of the propeller and the second number represents the pitch. For example, 14x19 represents a propeller with a 14 inch diameter and 19 inches of pitch.

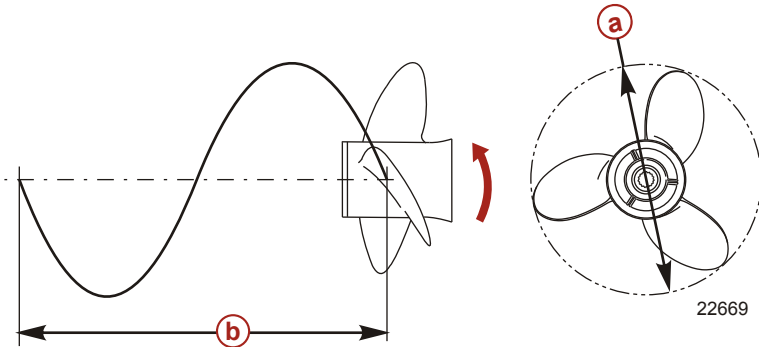

**a** - Diameter

**b** - Pitch - Travel during one revolution

The following are some propeller basics that will help you determine the correct propeller for your boating application.

**Diameter** - The diameter is the distance across the imaginary circle that is made when the propeller rotates. The correct diameter for each propeller has been predetermined for the design of your outboard. However, when more than one diameter is available for the same pitch, use a larger diameter for heavy boat applications and a smaller diameter for lighter applications.

**Pitch** - The pitch is the theoretical distance, in inches, that a propeller travels forward during one revolution. Pitch can be thought of similar to gears in a car. The lower the gear, the faster the car will accelerate, but with lower overall top speed. Likewise, a lower pitch propeller will accelerate quickly, but top-end speed will be reduced. The higher the propeller pitch the faster the boat will usually go; though typically slowing acceleration.

# GENERAL INFORMATION

**Determining the Correct Pitch size** - First, check the full throttle RPM under normal load condition. If the full throttle RPM is within the recommended range, select a replacement or upgrade propeller with the same pitch as the current propeller.

- Adding 1 inch of pitch will reduce the full throttle RPM by 150 to 200
- Subtracting 1 inch of pitch will increase full throttle RPM by 150 to 200
- Upgrading from a 3-blade propeller to a 4-blade propeller will generally decrease full throttle RPM by 50 to 100

**IMPORTANT: Avoid damage to the engine. Never use a propeller which allows the engine to exceed the recommended full throttle RPM range when under normal full throttle operation.**

## PROPELLER MATERIAL

Most propellers manufactured by Mercury Marine are made from either aluminum or stainless steel. Aluminum is suitable for general purpose use and is standard equipment on many new boats. Stainless steel is over five times more durable than aluminum and typically provides performance gains in acceleration and top end speed due to design efficiencies. Stainless steel propellers also come in a larger variety of sizes and styles that allow you to dial in the ultimate performance for your boat.

## 3 BLADE VS. 4 BLADE

Available in many sizes of both aluminum and stainless, 3 and 4-blade propellers have unique performance characteristics. In general, 3-blade propellers offer good all around performance and higher top speed than 4-blade propellers. However, 4-blade propellers are usually faster to plane and more efficient at cruising speeds, but lack the top end speed of a 3-blade propeller.

# GENERAL INFORMATION

## Outboard Remote Control Models

The remote control connected to your outboard must be equipped with a start in neutral only protection device. This prevents the engine from starting when the shift is actuated in any position other than neutral.

### WARNING

**Starting the engine with the drive in gear can cause serious injury or death. Never operate a boat that does not have a neutral-safety-protection device.**

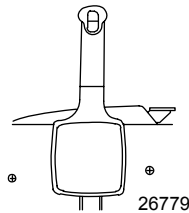

## Remote Steering Notice

The steering link rod that connects the steering cable to the engine must be fastened utilizing self-locking nuts. These self-locking nuts must never be replaced with common nuts (non-locking) as they will work loose and vibrate off, freeing the link rod to disengage.

# GENERAL INFORMATION

## ⚠ WARNING

Improper fasteners or improper installation procedures can result in loosening or disengagement of the steering link rod. This can cause a sudden, unexpected loss of boat control, resulting in serious injury or death due to occupants being thrown within or out of the boat. Always use required components and follow instructions and torque procedures.

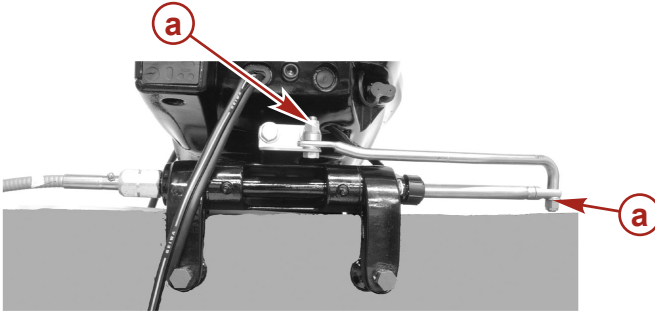

9938

**a** - Self-locking nuts

## Lanyard Stop Switch

The purpose of a lanyard stop switch is to turn off the engine when the operator moves far enough away from the operator's position (as in accidental ejection from the operator's position) to activate the switch. Tiller handle outboards and some remote control units are equipped with a lanyard stop switch. A lanyard stop switch can be installed as an accessory - generally on the dashboard or side adjacent to the operator's position.



## GENERAL INFORMATION

The lanyard is a cord usually 122–152 cm (4–5 feet) in length when stretched out, with an element on one end made to be inserted into the switch and a snap on the other end for attaching to the operator. The lanyard is coiled to make its at-rest condition as short as possible to minimize the likelihood of lanyard entanglement with nearby objects. Its stretched-out length is made to minimize the likelihood of accidental activation should the operator choose to move around in an area close to the normal operator's position. If it is desired to have a shorter lanyard, wrap the lanyard around the operator's wrist or leg, or tie a knot in the lanyard.

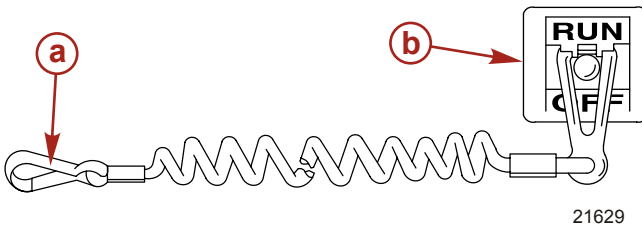

- a** - Lanyard cord
- b** - Lanyard stop switch

Read the following Safety Information before proceeding.

# GENERAL INFORMATION

**Important Safety Information:** The purpose of a lanyard stop switch is to stop the engine when the operator moves far enough away from the operator's position to activate the switch. This would occur if the operator accidentally falls overboard or moves within the boat a sufficient distance from the operator's position. Falling overboard and accidental ejections are more likely to occur in certain types of boats such as low sided inflatables, bass boats, high performance boats, and light, sensitive handling fishing boats operated by a hand tiller. Falling overboard and accidental ejections are also likely to occur as a result of poor operating practices such as sitting on the back of the seat or gunwale at planing speeds, standing at planing speeds, sitting on elevated fishing boat decks, operating at planing speeds in shallow or obstacle infested waters, releasing your grip on a steering wheel or tiller handle that is pulling in one direction, drinking alcohol or consuming drugs, or daring high speed boat maneuvers.

While activation of the lanyard stop switch will stop the engine immediately, a boat will continue to coast for some distance depending upon the velocity and degree of any turn at shut down. However, the boat will not complete a full circle. While the boat is coasting, it can cause injury to anyone in the boat's path as seriously as the boat would when under power.

We strongly recommend that other occupants be instructed on proper starting and operating procedures should they be required to operate the engine in an emergency (e.g. if the operator is accidentally ejected).

## **WARNING**

**If the operator falls out of the boat, stop the engine immediately to reduce the possibility of serious injury or death from being struck by the boat. Always properly connect the operator to the stop switch using a lanyard.**

# GENERAL INFORMATION

## WARNING

**Avoid serious injury or death from deceleration forces resulting from accidental or unintended stop switch activation. The boat operator should never leave the operator's station without first disconnecting the stop switch lanyard from the operator.**

Accidental or unintended activation of the switch during normal operation is also a possibility. This could cause any, or all, of the following potentially hazardous situations:

- Occupants could be thrown forward due to unexpected loss of forward motion - a particular concern for passengers in the front of the boat who could be ejected over the bow and possibly struck by the gearcase or propeller.
- Loss of power and directional control in heavy seas, strong current, or high winds.
- Loss of control when docking.

### **KEEP THE LANYARD STOP SWITCH AND LANYARD CORD IN GOOD OPERATING CONDITION**

Before each use, check to ensure the lanyard stop switch works properly. Start the engine and stop it by pulling the lanyard cord. If the engine does not stop, have the switch repaired before operating the boat.

Before each use, visually inspect the lanyard cord to ensure it is in good working condition and that there are no breaks, cuts, or wear to the cord. Check that the clips on the ends of the cord are in good condition. Replace any damaged or worn lanyard cords.

# GENERAL INFORMATION

## Protecting People in the Water

### WHILE YOU ARE CRUISING

It is very difficult for a person standing or floating in the water to take quick action to avoid a boat heading in his/her direction, even at slow speed.



Always slow down and exercise extreme caution any time you are boating in an area where there might be people in the water. Whenever a boat is moving (coasting) and the outboard gear shift is in neutral position, there is sufficient force by the water on the propeller to cause the propeller to rotate. This neutral propeller rotation can cause serious injury.

### WHILE BOAT IS STATIONARY

#### **WARNING**

**A spinning propeller, a moving boat, or any solid device attached to the boat can cause serious injury or death to swimmers. Stop the engine immediately whenever anyone in the water is near your boat.**

Shift outboard into neutral and shut off the engine before allowing people to swim or be in the water near your boat.

# GENERAL INFORMATION

## Passenger Safety Message - Pontoon Boats and Deck Boats

Whenever the boat is in motion, observe the location of all passengers. Do not allow any passengers to stand or use seats other than those designated for traveling faster than idle speed. A sudden reduction in boat speed, such as plunging into a large wave or wake, a sudden throttle reduction, or a sharp change of boat direction, could throw them over the front of the boat. Falling over the front of the boat between the two pontoons will position them to be run over by the outboard.

### BOATS HAVING AN OPEN FRONT DECK

No one should ever be on the deck in front of the fence while the boat is in motion. Keep all passengers behind the front fence or enclosure.

Persons on the front deck could easily be thrown overboard or persons dangling their feet over the front edge could get their legs caught by a wave and pulled into the water.

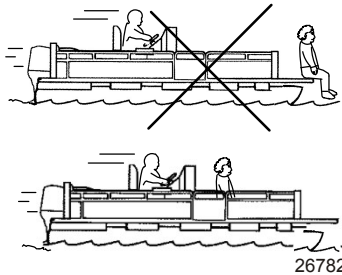

### **⚠ WARNING**

**Sitting or standing in an area of the boat not designed for passengers at speeds above idle can cause serious injury or death. Stay back from the front end of deck boats or raised platforms and remain seated while the boat is in motion.**

# GENERAL INFORMATION

## BOATS WITH FRONT MOUNTED, RAISED PEDESTAL FISHING SEATS

Elevated fishing seats are not intended for use when the boat is traveling faster than idle or trolling speed. Sit only in seats designated for traveling at faster speeds.

Any unexpected, sudden reduction in boat speed could result in the elevated passenger falling over the front of the boat.

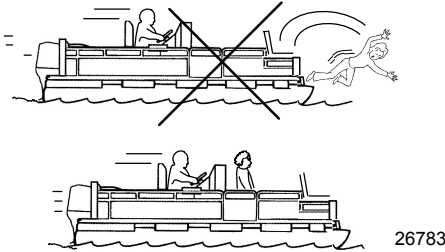

## Wave and Wake Jumping

Operating recreational boats over waves and wake is a natural part of boating. However, when this activity is done with sufficient speed to force the boat hull partially or completely out of the water, certain hazards arise, particularly when the boat reenters the water.

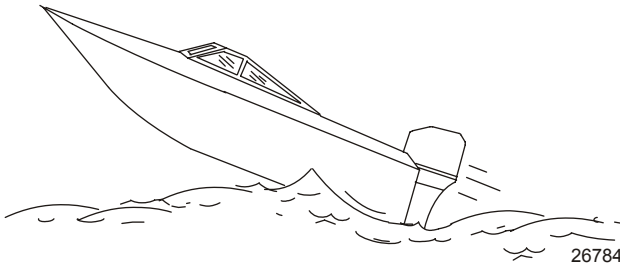

The primary concern is the boat changing direction while in the midst of the jump. In such case, the landing may cause the boat to veer violently in a new direction. Such a sharp change in direction can cause occupants to be thrown out of their seats, or out of the boat.

# GENERAL INFORMATION

## ⚠ WARNING

Wave or wake jumping can cause serious injury or death from occupants being thrown within or out of the boat. Avoid wave or wake jumping whenever possible.

There is another less common hazardous result from allowing your boat to launch off a wave or wake. If the bow of your boat pitches down far enough while airborne, upon water contact it may penetrate under the water surface and submarine for an instant. This will bring the boat to a nearly instantaneous stop and can send the occupants flying forward. The boat may also steer sharply to one side.

## Impact with Underwater Hazards

Reduce speed and proceed with caution whenever you drive a boat in shallow water areas, or in areas where you suspect underwater obstacles may exist which could be struck by the outboard or the boat bottom. **The most important thing you can do to help reduce injury or impact damage from striking a floating or underwater object is to control the boat speed. Under these conditions, boat speed should be kept to a minimum planing speed of 24 to 40 km/h (15 to 25 MPH).**

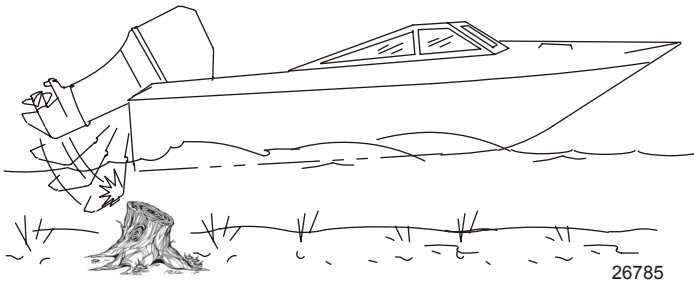

Striking a floating or underwater object could result in an infinite number of situations. Some of these situations could result in the following:

- Part of the outboard or the entire outboard could break loose and fly into the boat.

## GENERAL INFORMATION

- The boat could move suddenly in a new direction. Such a sharp change in direction can cause occupants to be thrown out of their seats or out of the boat.
- A rapid reduction in speed. This will cause occupants to be thrown forward, or even out of the boat.
- Impact damage to the outboard and/or boat.

Keep in mind, the most important thing you can do to help reduce injury or impact damage during an impact is control the boat speed. Boat speed should be kept to a minimum planing speed when driving in waters known to have underwater obstacles.

After striking a submerged object, stop the engine as soon as possible and inspect it for any broken or loose parts. If damage is present or suspected, the outboard should be taken to an authorized dealer for a thorough inspection and necessary repair.

The boat should also be checked for any hull fractures, transom fractures, or water leaks.

Operating a damaged outboard could cause additional damage to other parts of the outboard, or could affect control of the boat. If continued running is necessary, do so at greatly reduced speeds.

### WARNING

**Operating a boat or engine with impact damage can result in product damage, serious injury, or death. If the vessel experiences any form of impact, have an authorized Mercury Marine dealer inspect and repair the vessel or power package.**

## Safety Instructions for Hand-Tilled Outboards

No person or cargo should occupy the area directly in front of the outboard while the boat is in motion. If an underwater obstacle is struck, the outboard will tilt up and could seriously injure anyone occupying this area.



# GENERAL INFORMATION

## MODELS WITH CLAMP SCREWS:

Some outboards come with transom bracket clamp screws. The use of clamp bracket screws alone, is insufficient to properly and safely secure the outboard to the transom. Proper installation of the outboard includes bolting the engine to the boat through the transom. Refer to **Installation - Installing Outboard** for more complete installation information.

### **WARNING**

**Failure to correctly fasten the outboard could result in the outboard propelling off the boat transom resulting in property damage, serious injury, or death. Before operation, the outboard must be correctly installed with the required mounting hardware. Do not accelerate above idle speed in water that may contain underwater obstacles if the outboard is not attached to the transom correctly.**

If an obstacle is struck at planing speed and the outboard is not securely fastened to the transom, it is possible the outboard could lift off the transom and land in the boat.

## Exhaust Emissions

### BE ALERT TO CARBON MONOXIDE POISONING

Carbon monoxide is present in the exhaust fumes of all internal combustion engines. This includes the outboards, sterndrives, and inboard engines that propel boats, as well as the generators that power various boat accessories. Carbon monoxide is a deadly gas that is odorless, colorless, and tasteless.

Early symptoms of carbon monoxide poisoning which should not be confused with seasickness or intoxication, include headache, dizziness, drowsiness, and nausea.

# GENERAL INFORMATION

## WARNING

Carbon monoxide poisoning can lead to unconsciousness, brain damage, or death. Keep the boat well ventilated while at rest or underway and avoid prolonged exposure to carbon monoxide.

### GOOD VENTILATION

Ventilate passenger area, open side curtains or forward hatches to remove fumes.

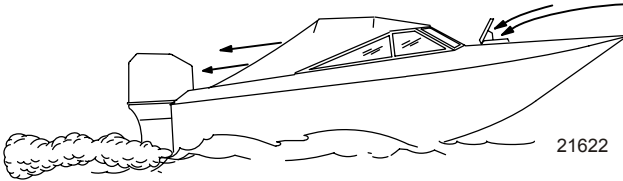

**Example of desired air flow through the boat**

### POOR VENTILATION

Under certain running and/or wind conditions, permanently enclosed or canvas enclosed cabins or cockpits with insufficient ventilation may draw in carbon monoxide. Install one or more carbon monoxide detectors in your boat.

Although the occurrence is rare, on a very calm day, swimmers and passengers in an enclosed area of a stationary boat that contains or is near a running engine may be exposed to a hazardous level of carbon monoxide.

# GENERAL INFORMATION

## WHILE BOAT IS STATIONARY

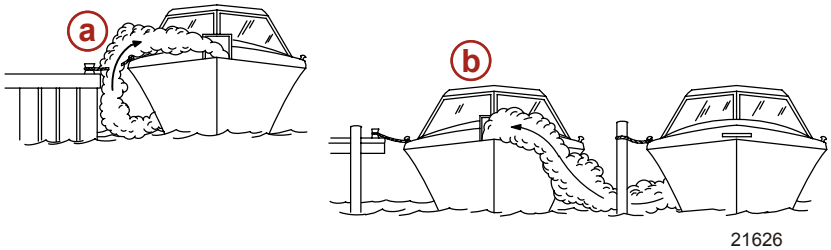

- a** - Running the engine when the boat is moored in a confined space
- b** - Mooring close to another boat that has its engine running

## WHILE BOAT IS MOVING

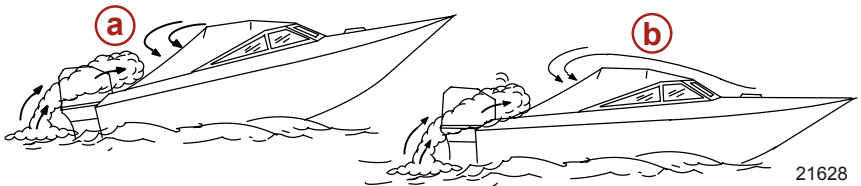

- a** - Running the boat with the trim angle of the bow too high
- b** - Running the boat with no forward hatches open

## Selecting Accessories for Your Outboard

Genuine Mercury Precision or Quicksilver Accessories have been specifically designed and tested for your outboard. These accessories are available from Mercury Marine dealers.

**IMPORTANT: Check with your dealer before installing accessories. The misuse of approved accessories or the use of nonapproved accessories can damage the product.**

Some accessories not manufactured or sold by Mercury Marine are not designed to be safely used with your outboard or outboard operating system. Acquire and read the installation, operation and maintenance manuals for all your selected accessories.

# GENERAL INFORMATION

## Safe Boating Suggestions

In order to safely enjoy the waterways, familiarize yourself with local and other governmental boating regulations and restrictions, and consider the following suggestions.

**Use flotation devices.** Have an approved personal flotation device of suitable size for each person aboard (it is the law) and have it readily accessible.

**Do not overload your boat.** Most boats are rated and certified for maximum load (weight) capacities (refer to your boat capacity plate). If in doubt, contact your dealer or the boat's manufacturer.

**Perform safety checks and required maintenance.** Follow a regular schedule and ensure that all repairs are properly made.

**Know and obey all nautical rules and laws of the waterways.**

Boat operators should complete a boating safety course.

Courses are offered in the U.S.A. by 1) the U.S. Coast Guard Auxiliary, 2) the Power Squadron, 3) the Red Cross, and 4) your state boating law enforcement agency. Inquiries may be made to the Boating Hotline, 1-800-368-5647 or the Boat U.S. Foundation information number 1-800-336-BOAT.

**Make sure everyone in the boat is properly seated.** Do not allow anyone to sit or ride on any part of the boat that was not intended for such use. This includes the back of seats, gunwales, transom, bow, decks, raised fishing seats, any rotating fishing seat; or anywhere that an unexpected acceleration, sudden stopping, unexpected loss of boat control, or sudden boat movement could cause a person to be thrown overboard or into the boat.

**Never be under the influence of alcohol or drugs while boating (it is the law).** Alcohol or drug use impairs your judgment and greatly reduces your ability to react quickly.

**Prepare other boat operators.** Instruct at least one other person onboard in the basics of starting and operating the outboard, and boat handling, in case the driver becomes disabled or falls overboard.

**Passenger boarding.** Stop the engine whenever passengers are boarding, unloading, or are near the back (stern) of the boat. Just shifting the outboard into neutral is not sufficient.

## GENERAL INFORMATION

**Be alert.** The operator of the boat is responsible by law to maintain a proper lookout by sight and hearing. The operator must have an unobstructed view particularly to the front. No passengers, load, or fishing seats should block the operator's view when operating the boat above idle speed.

**Never drive your boat directly behind a water-skier in case the skier falls.** As an example, your boat traveling at 40 km/h (25 MPH) will overtake a fallen skier 61 m (200 ft) in front of you in 5 seconds.

**Watch fallen skiers.** When using your boat for waterskiing or similar activities, always keep a fallen or down skier on the operator's side of the boat while returning to assist the skier. The operator should always have the down skier in sight and never back up to the skier or anyone in the water.

**Report accidents.** Boat operators are required by law to file a Boating Accident Report with their state boating law enforcement agency when their boat is involved in certain boating accidents. A boating accident must be reported if 1) there is loss of life or probable loss of life, 2) there is personal injury requiring medical treatment beyond first aid, 3) there is damage to boats or other property where the damage value exceeds \$500.00, or 4) there is complete loss of the boat. Seek further assistance from local law enforcement.

# GENERAL INFORMATION

## Recording Serial Number

It is important to record this number for future reference. The serial number is located on the outboard as shown.

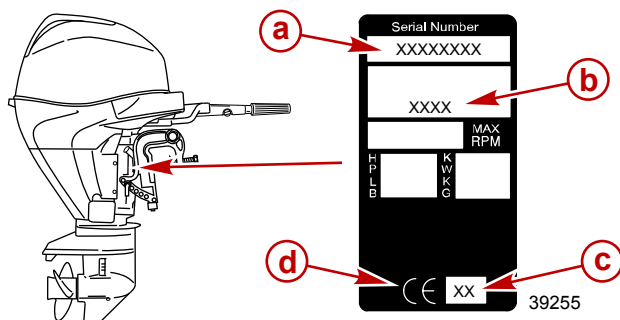

- a** - Serial number
- b** - Model designation
- c** - Year manufactured
- d** - Certified Europe Insignia (as applicable)

## Specifications

Models	25	30
Power	18.4 kw (25 hp)	22.1 kw (30 hp)
Full throttle RPM range	5000–6000 RPM	5250–6250 RPM
Idle speed in forward gear	850 ± 25 RPM	
Number of cylinders	3	
Piston displacement	526 cc (32.09 cid)	
Cylinder bore	61.0 mm (2.40 in.)	
Stroke	60 mm (2.36 in.)	
Valve clearance (cold)		
Intake valve	0.13–0.17 mm (0.005–0.007 in.)	
Exhaust valve	0.18–0.22 mm (0.007–0.008 in.)	
Recommended spark plug	NGK DCPR6E	
Spark plug gap	0.8–0.9 mm (0.031–0.035 in.)	
Gear ratio	1.92:1	
Recommended gasoline	Refer to <b>Fuel and Oil</b>	

## GENERAL INFORMATION

Models	25	30
Recommended oil	Refer to <b>Fuel and Oil</b>	
Gearcase lubricant capacity	350 ml (11.8 fl oz)	
Engine oil capacity	1.8 liter (1.9 US qt)	
Battery rating	465 marine cranking amps (MCA) or 350 cold cranking amps (CCA)	
Emission control system	Electronic engine control (EC)	
Sound at drivers ear (ICOMIA 39-94) dBA	80.9	
Tiller handle vibration (ICOMIA 38-94) m/s <sup>2</sup>	5.3	

# GENERAL INFORMATION

## Component Identification

### MANUAL TILT MODEL

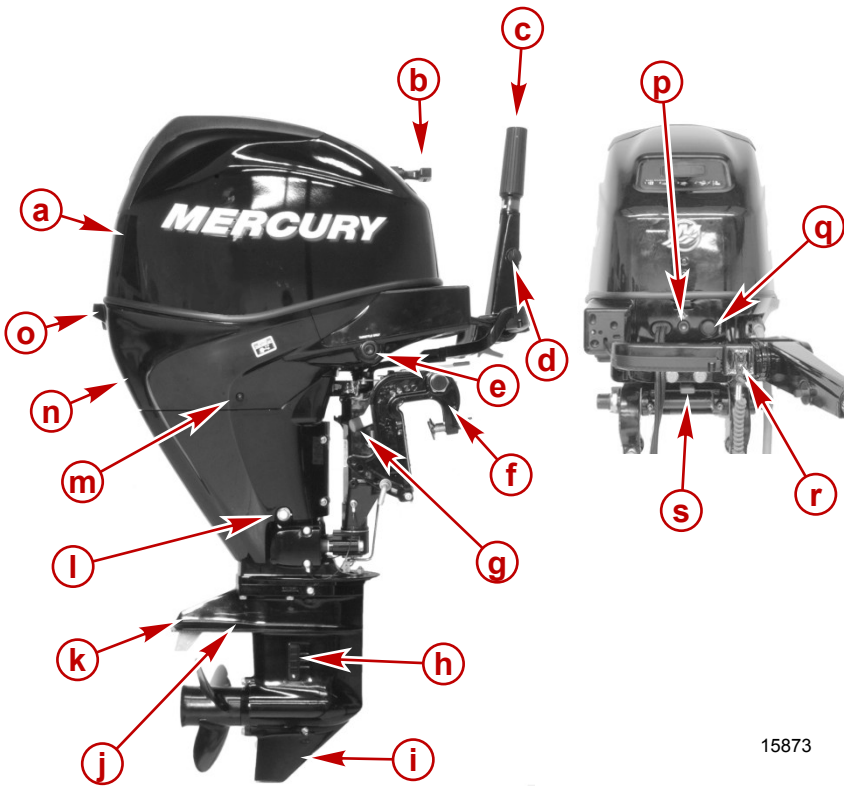

15873

- a** - Top cowl
- b** - Manual start handle
- c** - Engine stop switch
- d** - Throttle friction adjustment knob
- e** - Throttle only button
- f** - Transom brackets
- g** - Tilt lock lever
- h** - Primary cooling water intake
- i** - Gearcase
- j** - Secondary cooling water intake
- k** - Anti-ventilation plate



# GENERAL INFORMATION

- l** - Oil drain screw
- m** - Water pump indicator hole
- n** - Bottom cowl
- o** - Cowl latch
- p** - Warning light
- q** - Starting button (electric start models)
- r** - Lanyard stop switch
- s** - Steering friction adjustment lever

# GENERAL INFORMATION

## MANUAL GAS ASSIST TILT MODEL

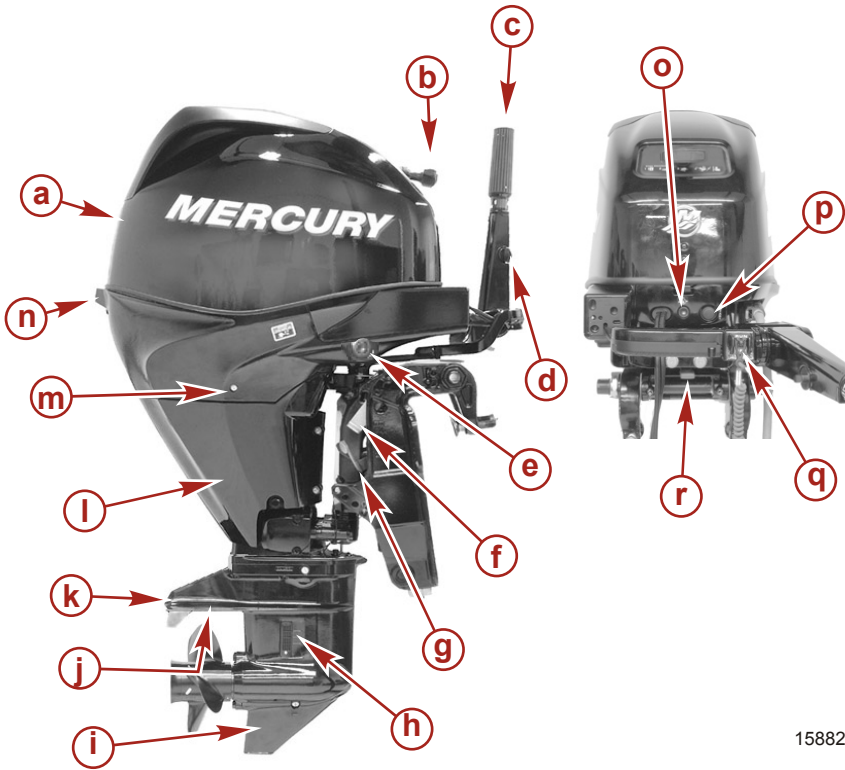

15882

- a** - Top cowl
- b** - Manual start handle
- c** - Engine stop switch
- d** - Throttle friction adjustment knob
- e** - Throttle only button
- f** - Tilt support lever
- g** - Gas assist tilt lever
- h** - Primary cooling water intake
- i** - Gearcase
- j** - Secondary cooling water intake
- k** - Anti-ventilation plate
- l** - Chaps

# GENERAL INFORMATION

- m** - Water pump indicator hole
- n** - Cowl latch
- o** - Warning light
- p** - Starting button (electric start models)
- q** - Lanyard stop switch
- r** - Steering friction adjustment lever

# GENERAL INFORMATION

## POWER TRIM MODEL

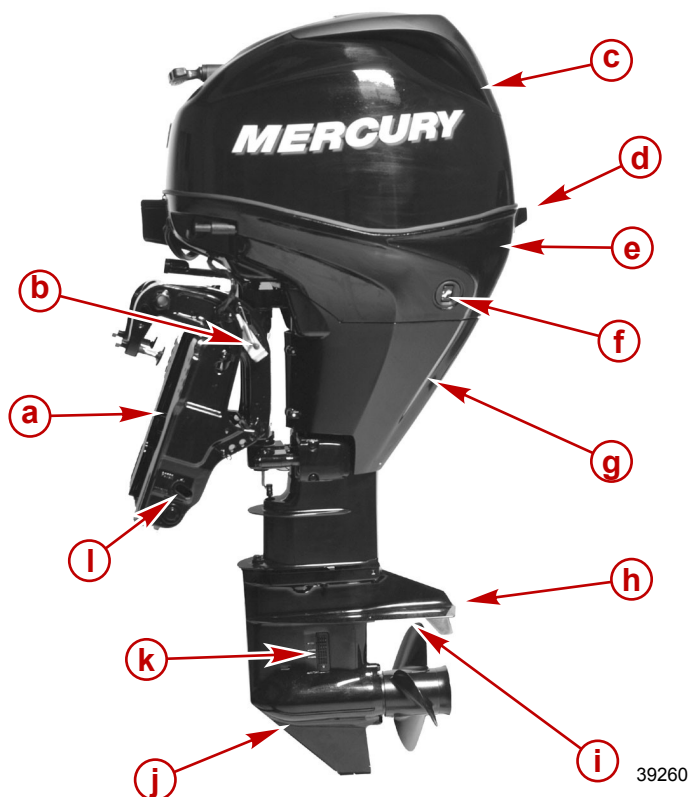

- a** - Transom brackets
- b** - Tilt support lever
- c** - Top cowl
- d** - Cowl latch
- e** - Bottom cowl
- f** - Auxiliary tilt switch
- g** - Chaps
- h** - Anti-ventilation plate
- i** - Secondary cooling water intake
- j** - Gearcase
- k** - Primary cooling water intake

# GENERAL INFORMATION

I - Manual tilt release valve

# TRANSPORTING

## Trailing Boat/Outboard

Trailer your boat with the outboard tilted down in a vertical operating position. Shift the engine into reverse.

If additional ground clearance is required, the outboard should be tilted up using an accessory outboard support device. Refer to your local dealer for recommendations. Additional clearance may be required for railroad crossings, driveways and trailer bouncing.

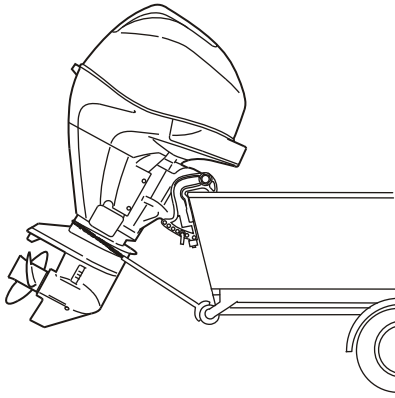

10218

**IMPORTANT:** Do not rely on the power trim/tilt system or tilt support lever to maintain proper ground clearance for trailering. The outboard tilt support lever is not intended to support the outboard for trailering.

Shift the outboard to reverse gear. This prevents the propeller from spinning freely.

## Transporting Your Outboard When Removed From Boat

**IMPORTANT:** Ensure the proper procedures are followed for transportation and storage of the outboard to avoid the possibility of oil leaks.

# TRANSPORTING

1. To prevent problems which can be caused by oil entering the cylinders from the sump, transport and store the outboard only in one of the two positions shown.

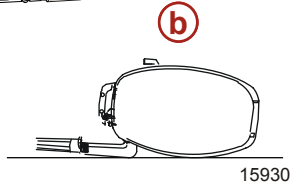
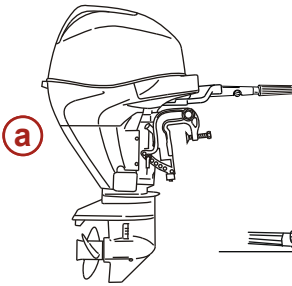

- a - Upright
- b - Tiller handle side down

## Transporting Portable Fuel Tanks

### WARNING

Avoid serious injury or death from a gasoline fire or explosion. Follow the transporting instructions supplied with the portable fuel tank. Transport the fuel tank in a well ventilated area away from open flame or sparks.

### MANUAL VENTING TYPE FUEL TANK

Close fuel tank air vent when transporting tank. This will prevent escape of fuel or vapors from tank.

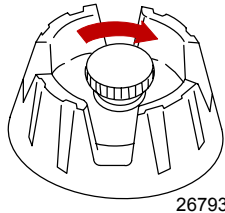

### AUTO-VENTING TYPE FUEL TANK

1. Disconnect the remote fuel line from tank. This will close the air vent and prevent escape of fuel or vapors from tank.

## TRANSPORTING

2. Install tether cap over the fuel line connector stem. This will protect the connector stem from being accidentally pushed-in, allowing fuel or vapor to escape.

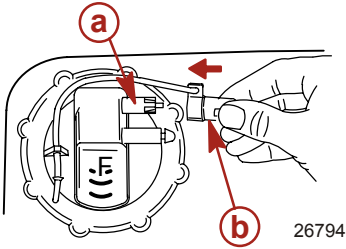

- a** - Connector stem
- b** - Tether cap



# FUEL AND OIL

## Fuel Recommendations

**IMPORTANT: Use of improper gasoline can damage your engine. Engine damage resulting from the use of improper gasoline is considered misuse of the engine, and damage caused thereby will not be covered under the limited warranty.**

### FUEL RATINGS

Mercury Marine engines will operate satisfactorily when using a major brand of unleaded gasoline meeting the following specifications:

**USA and Canada** - having a posted pump Octane Rating of 87 (R+M)/2 minimum. Premium gasoline (92 [R+M]/2 Octane) is also acceptable. Do not use leaded gasoline.

**Outside USA and Canada** - having a posted pump Octane Rating of 90 RON minimum. Premium gasoline (98 RON) is also acceptable. If unleaded gasoline is not available, use a major brand of leaded gasoline.

### USING REFORMULATED (OXYGENATED) GASOLINES (USA ONLY)

This type of gasoline is required in certain areas of the USA. The 2 types of oxygenates used in these fuels are alcohol (ethanol) or ether (MTBE or ETBE). If ethanol is the oxygenate that is used in the gasoline in your area, refer to **Gasolines Containing Alcohol**.

These reformulated gasolines are acceptable for use in your Mercury Marine engine.

### GASOLINES CONTAINING ALCOHOL

If the gasoline in your area contains either methanol (methyl alcohol) or ethanol (ethyl alcohol), you should be aware of certain adverse effects that can occur. These adverse effects are more severe with methanol. Increasing the percentage of alcohol in the fuel can also worsen these adverse effects.

Some of these adverse effects are caused because the alcohol in the gasoline can absorb moisture from the air, resulting in a separation of the water/alcohol from the gasoline in the fuel tank.

## FUEL AND OIL

The fuel system components on your Mercury Marine engine will withstand up to 10% alcohol content in the gasoline. We do not know what percentage your boat's fuel system will withstand. Contact your boat manufacturer for specific recommendations on the boat's fuel system components (fuel tanks, fuel lines, and fittings). Be aware that gasolines containing alcohol may cause increased:

- Corrosion of metal parts
- Deterioration of rubber or plastic parts
- Fuel permeation through rubber fuel lines
- Starting and operating difficulties

### WARNING

**Fuel leakage is a fire or explosion hazard, which can cause serious injury or death. Periodically inspect all fuel system components for leaks, softening, hardening, swelling, or corrosion, particularly after storage. Any sign of leakage or deterioration requires replacement before further engine operation.**

Because of possible adverse effects of alcohol in gasoline, it is recommended that only alcohol-free gasoline be used where possible. If only fuel containing alcohol is available, or if the presence of alcohol is unknown, increased inspection frequency for leaks and abnormalities is required.

**IMPORTANT:** When operating a Mercury Marine engine on gasoline containing alcohol, storage of gasoline in the fuel tank for long periods should be avoided. Long periods of storage, common to boats, create unique problems. In cars, alcohol-blend fuels normally are consumed before they can absorb enough moisture to cause trouble, but boats often sit idle long enough for phase separation to take place. In addition, internal corrosion may take place during storage if alcohol has washed protective oil films from internal components.

# FUEL AND OIL

## Low Permeation Fuel Hose Requirement

Required for outboards manufactured for sale, sold, or offered for sale in the United States.

- The Environmental Protection Agency (EPA) requires that any outboard manufactured after January 1, 2009 must use low permeation fuel hose for the primary fuel hose connecting the fuel tank to the outboard.
- Low permeation hose is USCG Type B1-15 or Type A1-15, defined as not exceeding  $15/\text{gm}^2/24 \text{ h}$  with CE 10 fuel at  $23 \text{ }^\circ\text{C}$  as specified in SAE J 1527 - marine fuel hose.

## Filling Fuel Tank

### WARNING

**Avoid serious injury or death from a gasoline fire or explosion. Use caution when filling fuel tanks. Always stop the engine and do not smoke or allow open flames or sparks in the area while filling fuel tanks.**

Fill fuel tanks outdoors away from heat, sparks, and open flames.

Remove portable fuel tanks from boat to refill them.

Always stop engine before refilling tanks.

Do not completely fill the fuel tanks. Leave approximately 10% of the tank volume unfilled. Fuel will expand in volume as its temperature rises and can leak under pressure if the tank is completely filled.

## PORTABLE FUEL TANK PLACEMENT IN THE BOAT

Place the fuel tank in the boat so the vent is higher than the fuel level under normal boat operating conditions.

# FUEL AND OIL

## Engine Oil Recommendations

We recommend the use of Mercury or Quicksilver NMMA FC-W certified 10W-30 4-Stroke Outboard Oil for general, all-temperature use. If NMMA certified synthetic blend 25W-40 4-Stroke outboard oil is preferred, use Mercury or Quicksilver synthetic blend 4-Stroke Outboard Oil. If the recommended Mercury or Quicksilver NMMA FC-W certified outboard oils are not available, a major FC-W certified 4-stroke outboard oil may be used.

**IMPORTANT:** The use of detergent oils, multi-viscosity oils (other than Mercury or Quicksilver NMMA FC-W certified oil or a major brand NMMA FC-W certified oil), synthetic oils, low quality or oils that contain solid additives are not recommended.

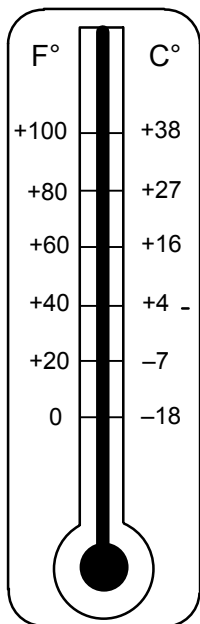

### Recommended SAE viscosity for engine oil

- a** - NMMA FC-W certified 25W-40 4-stroke outboard oil may be used at temperatures above 4 °C (40 °F)
- b** - NMMA FC-W certified 10W-30 4-stroke outboard oil is recommended for use in all temperatures.

## Checking And Adding Engine Oil

**IMPORTANT:** Do not overfill. Be sure that the outboard is upright (not tilted) when checking oil.

1. Turn the engine off. Have the outboard in a level operating position. Remove the top cowl.

## FUEL AND OIL

2. Pull out the dipstick. Wipe it with a clean rag or towel and push it back in all the way.

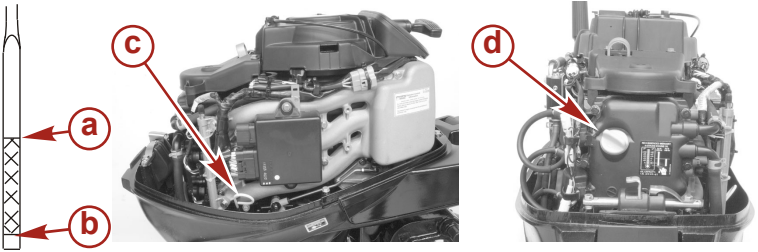

9596

- a** - Full mark
- b** - Add mark
- c** - Dipstick
- d** - Oil fill cap

3. Pull the dipstick back out again and observe the oil level. Oil must be between full mark and add mark. If the oil level is low, remove the oil fill cap and fill to (but not over) the upper oil level.

**NOTE:** Under certain conditions, the operating temperature of 4-stroke outboard engines may not get hot enough to evaporate the normal fuel and moisture that accumulate in the crankcase. These conditions include operating at idle for long periods, repeated short trips, slow speed or quick stop-and-go operation, and operating in cooler climates. This additional fuel and moisture that collects in the crankcase eventually ends up in the oil sump and will add to the total volume of oil that appears on the dipstick reading. This increase in oil volume is known as oil dilution. Outboard engines can typically handle large amounts of oil dilution without causing durability problems. However, to ensure extended life of the outboard engine, Mercury recommends that the oil and filter be changed regularly following the oil change interval and using the recommended oil quality. It is further recommended that if your outboard is operated frequently in the conditions described above, that more frequent oil change intervals be considered.

## FUEL AND OIL

4. Push the dipstick back in all the way. Reinstall the oil fill cap hand tight.

# FEATURES AND CONTROLS

## Remote Control Features

Your boat may be equipped with one of the Mercury Precision or Quicksilver remote controls shown. If not, consult your dealer for a description of the functions and operations of the remote control.

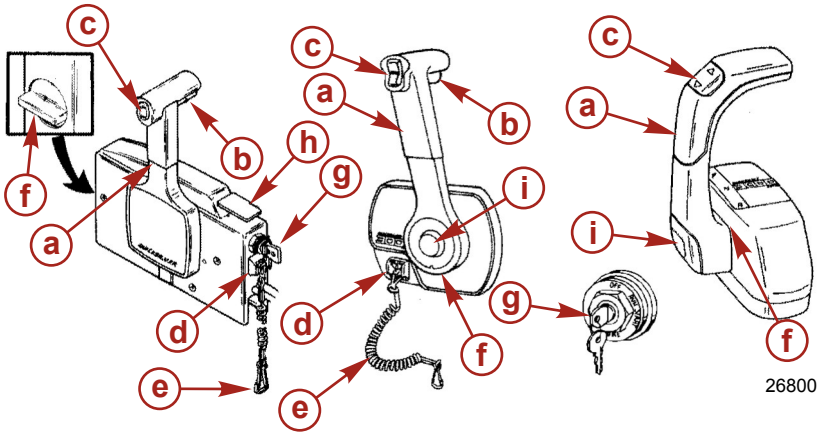

- a** - Control handle - forward, neutral, reverse
- b** - Neutral release lever
- c** - Trim/tilt switch (if equipped) - Refer to **Features and Controls - Power Trim and Tilt**
- d** - Lanyard stop switch - Refer to **General Information - Lanyard Stop Switch**
- e** - Lanyard - Refer to **General Information - Lanyard Stop Switch**
- f** - Throttle friction adjustment - Console controls require cover removal for adjustment
- g** - Ignition key switch - "OFF," "ON," "START"
- h** - Fast idle lever - Refer to **Operation - Starting the Engine**
- i** - Throttle only button - Refer to **Operation - Starting the Engine**

# FEATURES AND CONTROLS

## Tiller Handle Model Features

- Throttle only button - Pressing in the button while the outboard is in neutral allows the boat operator to increase engine RPM for warm-up, without shifting the engine into gear.

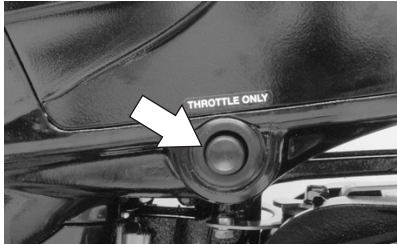

15894

- Steering friction adjustment - Adjust this lever to achieve the desired steering friction (drag) on the tiller handle. Move lever to the left to tighten friction or move to the right to loosen friction.

### WARNING

Insufficient friction adjustment can cause serious injury or death due to loss of boat control. When setting the friction adjustment, maintain sufficient steering friction to prevent the outboard from steering into a full turn if the tiller handle or steering wheel is released.

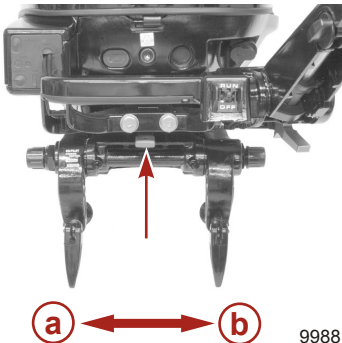

- a** - Tighten friction
- b** - Loosen friction

9988



## FEATURES AND CONTROLS

- Warning light - The warning light will turn on or flash to alert the operator to the warning system situations. Refer to **Warning System**.

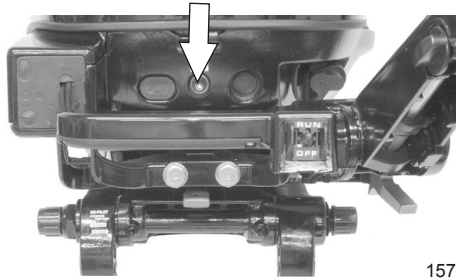

15732

- Electric start button (electric start models) - Press to start the engine.

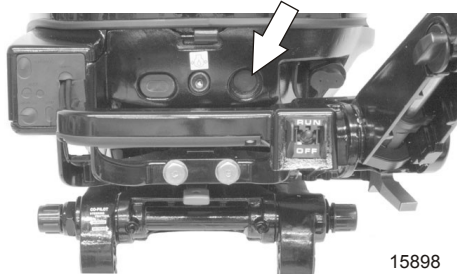

15898

## FEATURES AND CONTROLS

- Tiller handle - Handle can be tilted 180° for convenient handling during transportation and storage.

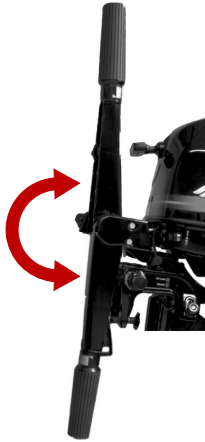

28535

- Tiller lock release lever - Push lever to move tiller handle from one position to another.

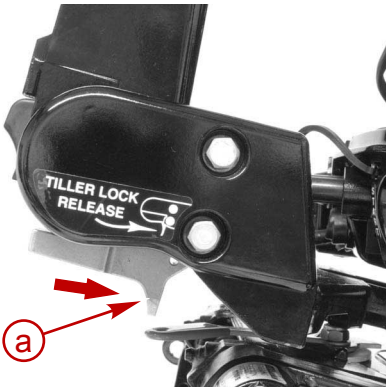

**a** - Tiller lock release lever

3274

# FEATURES AND CONTROLS

- Tiller handle lock cap - Remove the lock cap on top of tiller handle to lock in up position. Push tiller lock release lever to release the handle from the locked up position.

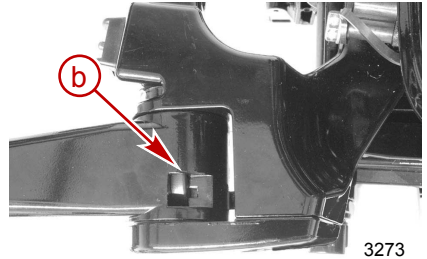
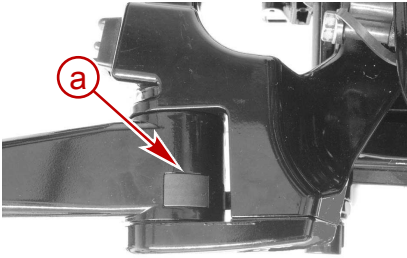

3273

- a** - Lock cap
- b** - Locking mechanism

- Engine stop switch



28537

- Throttle grip friction knob - Turn friction knob to set and maintain the throttle at desired speed. Turn the knob clockwise to tighten the friction or turn the knob counterclockwise to loosen the friction.

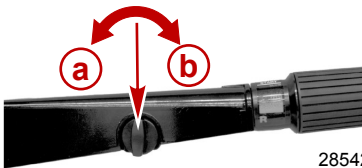

28542

- a** - Loosen friction (counterclockwise)
- b** - Tighten friction (clockwise)

# FEATURES AND CONTROLS

- Lanyard stop switch - Refer to **General Information - Lanyard Stop Switch**.



19791

## Warning System

### WARNING HORN

Remote control models will have the warning horn located inside the remote control or connected to the ignition key switch. Tiller handle models will have the warning horn located in the engine cowl.

### WARNING LIGHT

The warning light will turn on or flash to alert the operator to the warning system situations listed in the following chart.

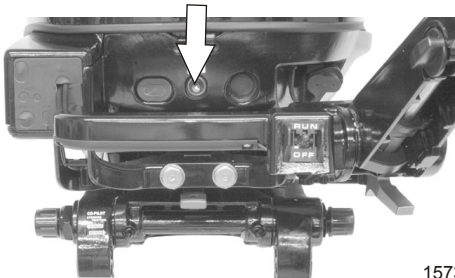

15732

### WARNING SYSTEM OPERATION

The warning horn will emit either a continuous beep or intermittent short beeps and engine speed will be limited. This will alert the operator and help identify the following listed situations.

# FEATURES AND CONTROLS

Warning System				
Function	Sound	Warning Light	Description	Engine Speed Limited to 2800 RPM
Start up	One beep	On for 5 seconds	Normal system test	
Engine over temperature	Continuous	On	Engine overheat	X
Low oil pressure	Continuous	On	Low oil pressure	X
Engine overspeed	Continuous	On	Engine speed exceeds maximum allowable RPM	
Water temp or MAP sensor out of range	Intermittent short beep	Flashes	Engine speed will be limited. Consult your dealer for assistance.	X

## ENGINE OVERHEAT

If the engine overheats, immediately reduce throttle speed to idle. Shift outboard into neutral and check for a steady stream of water coming out of the water pump indicator hole.



9647

If no water is coming out of the water pump indicator hole, or flow is intermittent, stop engine and check cooling water intake holes for obstruction. If no obstruction is found, this may indicate a blockage in the cooling system or a water pump problem. Have the outboard checked by your dealer. Operating the engine while overheated will cause engine damage.

# FEATURES AND CONTROLS

If a steady flow of water is coming out of the water pump indicator hole and the engine continues to overheat, consult your dealer. Operating an overheated engine will cause engine damage.

***NOTE:** Should overheating occur and you are stranded, stop the engine and allow it to cool down. This will usually allow some additional low speed (idle) running time before the engine starts to overheat again.*

## LOW OIL PRESSURE

The warning system will be activated if the oil pressure drops too low. First, stop the engine and check the oil level. Add oil if necessary. If the oil is at the recommended level and the warning horn continues to sound, consult your dealer. Engine speed will be limited to 2800 RPM, however, you should not continue to run engine.

## ENGINE OVERSPEED LIMITER

Some causes of engine overspeed are as follows:

- Propeller ventilation
- A propeller which has an incorrect pitch or diameter
- Propeller hub slippage
- Outboard mounted too high on the transom
- Tilting the outboard out beyond a vertical position
- Cavitation of the propeller due to rough water or obstruction in the boat hull

When the engine overspeed limiter is activated, the engine timing will be momentarily retarded to decrease the engine speed. Excessive overspeed (above 6300 RPM) will result in cutout of the cylinders to prevent operation above this limit.

## Tiller Handle Models with Manual Gas Assist Tilt

Models equipped with a gas assisted tilt system allows the operator to lock the outboard at any tilt position from full down to full up.

This tilt system is designed to be adjusted when the outboard is idling in neutral or with the engine turned off.

# FEATURES AND CONTROLS

Before operating, the outboard must be locked in its tilt position by moving the lock lever to the lock position.

## WARNING

Operating the engine without engaging the tilt lock lever can cause serious injury or death. The outboard can tilt upwards when decelerating or operating in reverse, causing loss of boat control. Always lock the outboard in its run position before operating.

### BASIC TILTING OPERATION

Move lock lever to the free position. Tilt outboard to desired position and lock in place by moving the tilt lock lever back to the lock position.

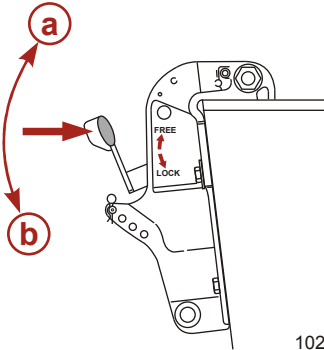

**a** - Free position

**b** - Lock position

10257

# FEATURES AND CONTROLS

## SHALLOW WATER OPERATION

When operating your boat in shallow water, the outboard can be adjusted and locked at a higher tilt angle. Operate your outboard at slow speed while tilted up for shallow water operation. Keep the cooling water intake holes submerged in the water and continue to check for water discharge from the water pump indicator hole.

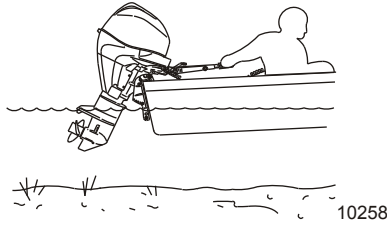

## TILTING OUTBOARD TO FULL UP POSITION

1. Stop the engine. Move the lock lever to the free position. Take hold of the top cowl grip and raise outboard to full tilt up position. Lock the outboard in place by moving the lock lever to the lock position.

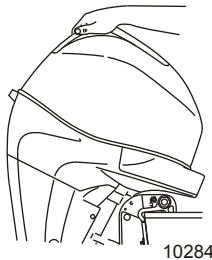

2. Engage the tilt support lever.
3. Lower outboard to rest on the tilt support lever.

## LOWERING OUTBOARD TO RUN POSITION

1. Move lock lever to the free position. Tilt up the outboard slightly and release the tilt support lever. Lower outboard to run position.



# FEATURES AND CONTROLS

2. Move lock lever to the lock position.



9703

## OPERATING ANGLE ADJUSTMENT

The transom brackets have four holes for adjusting the vertical operating angle (forward stop movement) of the outboard. Use the tilt pin for adjustments in the four holes.

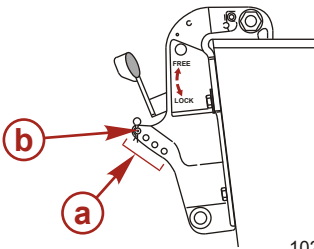

**a** - Transom bracket holes

**b** - Tilt pin

10290

Adjust the operating angle of the outboard so that the outboard runs perpendicular to the water when the boat is at full speed.

# FEATURES AND CONTROLS

Arrange passengers and load in the boat so the weight is distributed evenly.

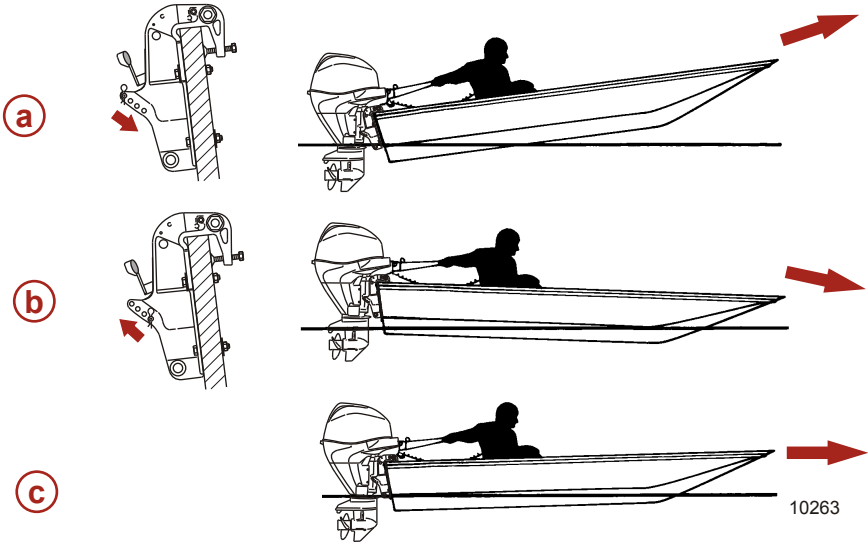

- a** - Too much angle (bow up) - adjust in
- b** - Not enough angle (bow down) - adjust out
- c** - Angle adjusted properly (bow slightly up)

**NOTE:** *The outboard should be locked against the tilt pin during operation by setting the tilt lock lever to the lock position.*

Consider the following lists carefully when adjusting the operating angle of your outboard.

Adjusting the outboard close to the boat transom can:

- Lower the bow.
- Result in quicker planing off, especially with a heavy load or a stern heavy boat.
- Generally improve the ride in choppy water.
- Increase steering torque or pull to the right (with the normal right hand rotation propeller).

# FEATURES AND CONTROLS

- In excess, can lower the bow of some boats to a point where they begin to plow with their bow in the water while on plane. This can result in an unexpected turn in either direction (called bow steering or oversteering) if any turn is attempted or if a significant wave is encountered.

Adjusting the outboard away from the boat transom can:

- Lift the bow out of the water.
- Generally increase top speed.
- Increase clearance over submerged objects or a shallow bottom.
- Increase steering torque or pull to the left at a normal installation height (with the normal right hand rotation propeller).
- In excess, can cause boat porpoising (bouncing) or propeller ventilation.

## Tiller Handle Models with Manual Tilt

### BASIC TILTING OPERATION

The tilt feature allows the operator to tilt the outboard to a higher tilt angle for operation in shallow water, or tilt the outboard to the full up position.

When running the outboard, keep the tilt lever in the release position. This allows the outboard to return to the running position if the outboard should ever hit an underwater obstacle and be lifted up.

Moving the tilt lever to the tilt position will allow the outboard to lock into the shallow water drive position or the full up position.

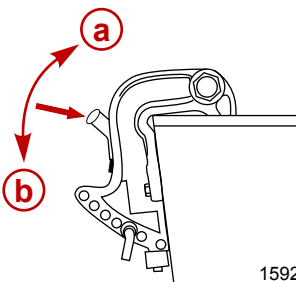

- a** - Release position
- b** - Tilt position

15920

# FEATURES AND CONTROLS

## TILTING OUTBOARD TO FULL UP POSITION

1. Stop the engine.
2. Shift the outboard to forward gear position.
3. Position the tilt lever to the tilt position.
4. Take hold of the top cowl grip and tilt the outboard all the way up until it locks in place.

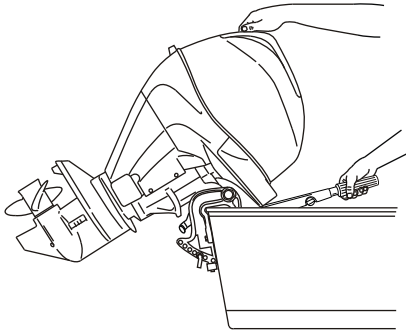

15924

## LOWERING OUTBOARD DOWN TO RUN POSITION

Position the tilt lever to the release position. Raise outboard slightly to release it from its locked position and gently lower it.

## SHALLOW WATER OPERATION

The shallow water drive position on the outboard allows you to position the outboard at a higher tilt angle to prevent hitting bottom.

**IMPORTANT:** Before tilting outboard into shallow water drive position, reduce engine speed to idle and shift engine into forward gear.

**IMPORTANT:** While in shallow water drive position, do not operate the outboard in reverse. Operate the outboard at slow speed and keep the cooling water intake submerged.

1. Reduce engine speed to idle.
2. Shift engine into forward gear position.
3. Position the tilt lever to the tilt position.
4. Take hold of the top cowl grip and tilt up the outboard until it locks in the shallow water running position.

## FEATURES AND CONTROLS

5. To release the outboard out of shallow water drive, position the tilt lever to the release position, and slightly lift up the outboard, and then gently lower it down.

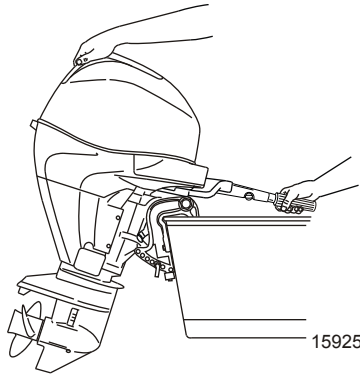

### SETTING THE OPERATION ANGLE OF YOUR OUTBOARD

The vertical operating angle of your outboard is adjusted by changing the position of the tilt pin in the six adjustment holes provided. Proper adjustment allows the boat to run stable, achieve optimum performance, and minimize steering effort.

**NOTE:** Refer to the following lists when adjusting the operating angle of your outboard.

The tilt pin should be adjusted so the outboard is positioned to run perpendicular to the water when the boat is running at full speed. This allows the boat to be driven parallel to the water.

# FEATURES AND CONTROLS

Arrange passengers and load in the boat so the weight is distributed evenly.

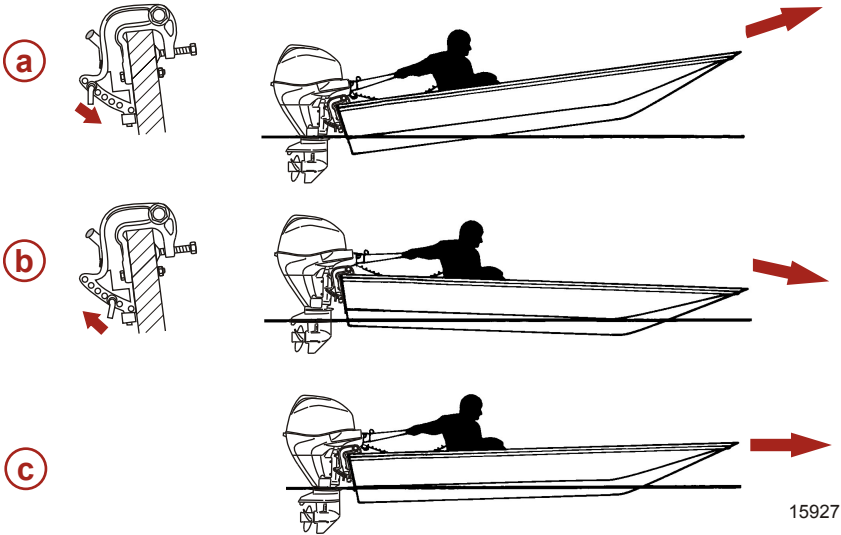

15927

- a** - Too much angle (stern down - bow up)
- b** - Not enough angle (stern up - bow down)
- c** - Angle adjusted properly (bow slightly up)

Consider the following lists carefully when adjusting the operating angle of your outboard.

Adjusting the outboard close to the boat transom can:

- Lower the bow.
- Result in quicker planing off, especially with a heavy load or a stern heavy boat.
- Generally improve the ride in choppy water.
- Increase steering torque or pull to the right (with the normal right hand rotation propeller).
- In excess, can lower the bow of some boats to a point where they begin to plow with their bow in the water while on plane. This can result in an unexpected turn in either direction (called bow steering or oversteering) if any turn is attempted, or if a significant wave is encountered.

# FEATURES AND CONTROLS

Adjusting the outboard away from the boat transom can:

- Lift the bow out of the water.
- Generally increase top speed.
- Increase clearance over submerged objects or a shallow bottom.
- Increase steering torque or pull to the left at a normal installation height (with the normal right hand rotation propeller).
- In excess, can cause boat porpoising (bouncing) or propeller ventilation.

# FEATURES AND CONTROLS

## Power Trim and Tilt (if Equipped)

Your outboard has a trim/tilt control called power trim. This enables the operator to easily adjust the position of the outboard by pressing the trim switch. Moving the outboard in closer to the boat transom is called trimming in or down. Moving the outboard further away from the boat transom is called trimming out or up. The term trim generally refers to the adjustment of the outboard within the first 20° range of travel. This is the range used while operating your boat on plane. The term tilt is generally used when referring to adjusting the outboard further up and out of the water. With the engine turned off, the outboard can be tilted out of the water. At low idle speed, the outboard can also be tilted up past the trim range to permit, for example, shallow water operation.

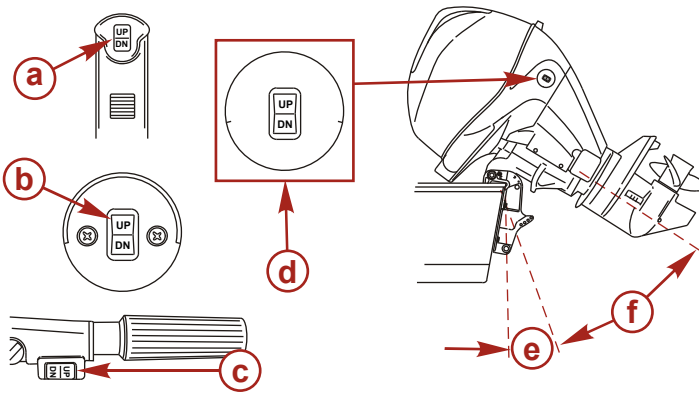

10265

- a** - Remote control trim switch
- b** - Panel mount trim switch
- c** - Tiller handle trim switch
- d** - Cowl mounted trim switch (option)
- e** - Trim range of travel
- f** - Tilt range of travel



# FEATURES AND CONTROLS

## POWER TRIM OPERATION

With most boats, operating around the middle of the trim range will give satisfactory results. However, to take full advantage of the trimming capability there may be times when you choose to trim your outboard all the way in or out. Along with an improvement in some performance aspects comes a greater responsibility for the operator, and this is being aware of some potential control hazards.

The most significant control hazard is a pull or torque that can be felt on the steering wheel or tiller handle. This steering torque results from the outboard being trimmed so that the propeller shaft is not parallel to the water surface.

### **WARNING**

**Trimming the outboard beyond a neutral steering condition may result in a pull on the steering wheel or tiller handle and loss of boat control. Maintain control of the boat if trimming beyond a neutral steering condition.**

Consider the following lists carefully.

1. Trimming in or down can:
  - Lower the bow.
  - Result in quicker planing off, especially with a heavy load or a stern heavy boat.
  - Generally improve the ride in choppy water.
  - Increase steering torque or pull to the right (with the normal right hand rotation propeller).
  - In excess, can lower the bow of some boats to a point where they begin to plow with their bow in the water while on plane. This can result in an unexpected turn in either direction (called bow steering or over-steering) if any turn is attempted, or if a significant wave is encountered.

# FEATURES AND CONTROLS

## WARNING

Operating the boat at high speeds with the outboard trimmed too far under can create excessive bow steer, resulting in the operator losing control of the boat. Install the trim limit pin in a position that prevents excessive trim under and operate the boat in a safe manner.

- In rare circumstances, the owner may decide to limit the trim in. This can be accomplished by repositioning the tilt stop pin into whatever adjustment hole in the transom bracket is desired.
2. Trimming out or up can:
- Lift the bow higher out of the water.
  - Generally increase top speed.
  - Increase clearance over submerged objects or a shallow bottom.
  - Increase steering torque or pull to the left at a normal installation height (with the normal right hand rotation propeller).
  - In excess, can cause boat porpoising (bouncing) or propeller ventilation.
  - Cause engine overheating if any cooling water intake holes are above the waterline.

## TILTING OPERATION

To tilt outboard, shut off the engine and press the trim/tilt switch or auxiliary tilt switch to the up position. The outboard will tilt up until the switch is released or it reaches its maximum tilt position.

1. Engage the tilt support lever by rotating lever down.
2. Lower outboard to rest on the tilt support lever.

## FEATURES AND CONTROLS

3. Disengage the tilt support lever, by slightly tilting up the outboard and releasing the tilt support bracket. Lower the outboard.



9703

### MANUAL TILTING

If the outboard cannot be tilted using the power trim/tilt switch, the outboard can be manually tilted.

**NOTE:** *The manual tilt release valve must be tightened before operating the outboard to prevent the outboard from tilting up during reverse operation.*

Turn out the manual tilt release valve 3 turns counterclockwise. This allows manual tilting of the outboard. Tilt the outboard to the desired position and tighten the manual tilt release valve.

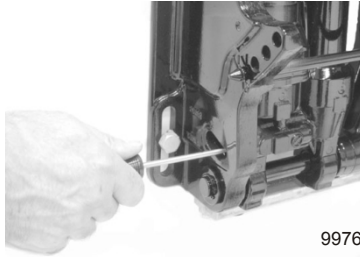

9976

# FEATURES AND CONTROLS

## AUXILIARY TILT SWITCH

The auxiliary tilt switch can be used to tilt the outboard up or down using the power trim system.

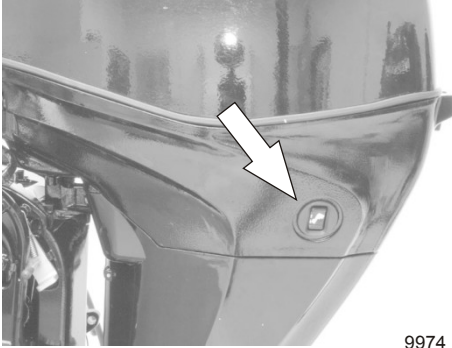

9974

## SHALLOW WATER OPERATION

When operating your boat in shallow water, you can tilt the outboard beyond the maximum trim range to prevent hitting bottom.

1. Reduce engine speed below 2000 RPM.
2. Tilt outboard up. Make sure all the water intake holes stay submerged at all times.
3. Operate the engine at slow speed only.

# FEATURES AND CONTROLS

## Trim Tab Adjustment

Propeller steering torque will cause your boat to pull in one direction. This steering torque is a normal result from your outboard not trimmed with the propeller shaft parallel to the water surface. The trim tab can help to compensate for this steering torque in many cases and can be adjusted within limits to reduce any unequal steering effort.

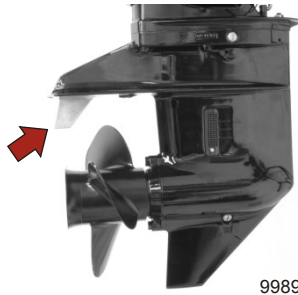

**NOTE:** *Trim tab adjustment will have little effect reducing steering torque if the outboard is installed with the anti-ventilation plate approximately 50 mm (2 in.) or more above the boat bottom.*

## MODELS WITHOUT POWER TRIM

Operate your boat at normal cruising speed trimmed to desired position by installing the tilt pin in the desired tilt pin hole. Turn your boat left and right and note the direction the boat turns more easily.

If adjustment is necessary, loosen trim tab bolt and make small adjustments at a time. If the boat turns more easily to the left, move the trailing edge of trim tab to the left. If the boat turns more easily to the right move the trailing edge of trim tab to the right. Retighten bolt and retest.

## MODELS WITH POWER TRIM

Operate your boat at normal cruising speed, trimmed to desired position. Turn your boat left and right and note the direction the boat turns more easily.

## FEATURES AND CONTROLS

If adjustment is necessary, loosen trim tab bolt and make small adjustments at a time. If the boat turns more easily to the left, move the trailing edge of trim tab to the left. If the boat turns more easily to the right move the trailing edge of trim tab to the right. Retighten bolt and retest.

# OPERATION

## Prestarting Check List

- Operator knows safe navigation, boating, and operating procedures.
- An approved personal flotation device of suitable size for each person aboard and readily accessible (it is the law).
- A ring type life buoy or buoyant cushion designed to be thrown to a person in the water.
- Know your boats' maximum load capacity. Look at the boat capacity plate.
- Fuel supply OK.
- Arrange passengers and load in the boat so the weight is distributed evenly and everyone is seated in a proper seat.
- Tell someone where you are going and when you expect to return.
- It is illegal to operate a boat while under the influence of alcohol or drugs.
- Know the waters and area you will be boating; tides, currents, sand bars, rocks, and other hazards.
- Make inspection checks listed in **Maintenance - Inspection and Maintenance Schedule**.

## Operating in Freezing Temperatures

When using your outboard or having your outboard moored in freezing or near freezing temperatures, keep the outboard tilted down at all times so the gearcase is submerged. This prevents the trapped water in the gearcase from freezing and causing possible damage to the water pump and other components.

If there is a chance of ice forming on the water, the outboard should be removed and drained completely of water. If ice should form at the water level inside the outboard driveshaft housing, it will block water flow to the engine causing possible damage.

# OPERATION

## Operating in Saltwater or Polluted Water

We recommend that you flush the internal water passages of your outboard with fresh water after each use in salt or polluted water. This will prevent a buildup of deposits from clogging the water passages. Refer to **Maintenance - Flushing the Cooling System**.

If you keep your boat moored in the water, always tilt the outboard so the gearcase is completely out of water (except in freezing temperatures) when not in use.

Wash the outboard exterior and flush out the exhaust outlet of the propeller and gearcase with fresh water after each use. Each month, spray Mercury Precision or Quicksilver Corrosion Guard on external metal surfaces. Do not spray on corrosion control anodes as this will reduce the effectiveness of the anodes.

## Pre-Starting Instructions

1. Connect the remote fuel line to the outboard. Make sure connector is snapped into place.



9600

2. Check the engine oil level.



9601



# OPERATION

## NOTICE

Without sufficient cooling water, the engine, the water pump, and other components will overheat and suffer damage. Provide a sufficient supply of water to the water inlets during operation.

3. Make sure the cooling water intake is submerged.

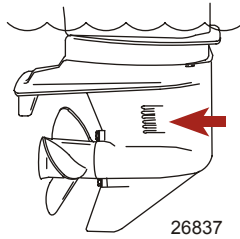

## Engine Break-in Procedure

**IMPORTANT:** Failure to follow the engine break-in procedures can result in poor performance throughout the life of the engine and can cause engine damage. Always follow break-in procedures.

1. For the first hour of operation, run the engine at varied throttle settings up to 3500 RPM or at approximately half throttle.
2. For the second hour of operation, run the engine at varied throttle settings up to 4500 RPM or at three-quarter throttle, and during this period of time, run it at full throttle for approximately one minute every ten minutes.
3. For the next eight hours of operation, avoid continuous operation at full throttle for more than five minutes at a time.

## Starting the Engine - Remote Control Models

Before starting, read the **Pre-Starting Check List**, **Pre-Starting Instructions**, and **Engine Break-in Procedure** in the **Operation** section.

# OPERATION

## NOTICE

Without sufficient cooling water, the engine, the water pump, and other components will overheat and suffer damage. Provide a sufficient supply of water to the water inlets during operation.

**NOTE:** If the outboard has run out of fuel, or has been in storage for an extended period of time, additional attempts to start the engine will be required to purge the fuel system of air.

1. Open fuel tank vent screw (in filler cap) on manual venting type fuel tanks.

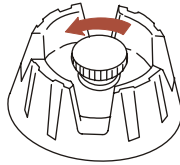

19748

2. Position the fuel line primer bulb so the arrow on the side of the bulb is pointing up. Squeeze the fuel line primer bulb several times until it feels firm.

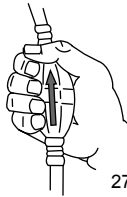

27348

**IMPORTANT:** To prevent engine flooding, do not squeeze the primer bulb after the engine has warmed up.

3. Set the lanyard stop switch to "RUN" position. Refer to **General Information - Lanyard Stop Switch**.



19791

# OPERATION

4. Shift outboard to neutral ("N") position.

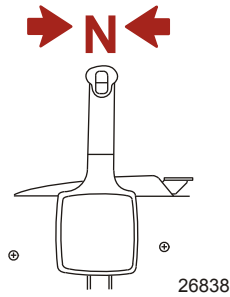

5. Move the neutral fast idle speed feature to the fully closed position.

**NOTE:** Starting flooded engine - Advance the neutral fast idle speed feature to the maximum fast idle speed position and continue to crank the engine for starting. Immediately reduce engine speed after engine starts.

6. Turn ignition key to the "START" position. If engine fails to start in ten seconds, return key to "ON" position, wait 30 seconds and try again.

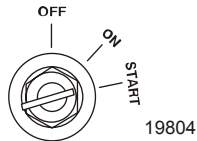

7. After engine starts, check for a steady stream of water flowing out of the water pump indicator hole.

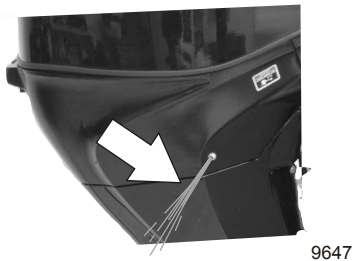

# OPERATION

**IMPORTANT:** If no water is coming out of the water pump indicator hole, stop engine and check cooling water intake for obstruction. No obstruction may indicate a water pump failure or blockage in the cooling system. These conditions will cause the engine to overheat. Have the outboard checked by your dealer. Operating the engine while overheated may cause serious engine damage.

## WARMING UP ENGINE

Before beginning operation, allow the engine to warm up at idling speed for three minutes.

## Starting the Engine - Tiller Handle Models

Before starting, read the **Pre-Starting Check List**, **Pre-Starting Instructions**, and **Engine Break-in Procedure** in the **Operation** section.

### NOTICE

Without sufficient cooling water, the engine, the water pump, and other components will overheat and suffer damage. Provide a sufficient supply of water to the water inlets during operation.

**NOTE:** *If the outboard has run out of fuel, or has been in storage for an extended period of time, additional attempts to start the engine will be required to purge the fuel system of air.*

1. Open fuel tank vent screw (in filler cap) on manual venting type fuel tanks.

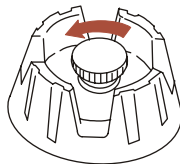

19748

# OPERATION

2. Position the fuel line primer bulb so the arrow on the side of the bulb is pointing up. Squeeze the fuel line primer bulb several times until it feels firm.

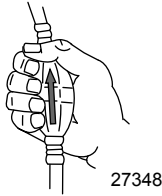

**IMPORTANT: To prevent engine flooding, do not squeeze the primer bulb after the engine has warmed up.**

3. Set the lanyard stop switch to "RUN" position. Refer to **General Information - Lanyard Stop Switch**.

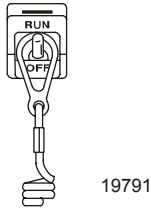

4. Set the tiller handle grip to neutral start position.

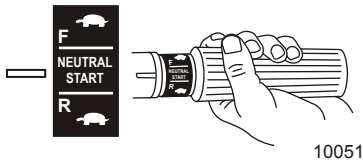

5. Models with gas assist tilt - Position the tilt lock lever to the lock position.

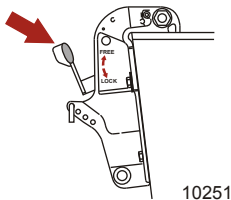

# OPERATION

6. Manual starting models - Pull the starter rope slowly, until you feel the starter engage, then pull rapidly to crank the engine. Allow rope to return slowly. Repeat until engine starts.



10173

7. Electric starting models - Push the starter button and crank the engine. Release button when engine starts. Do not operate starter motor continuously for longer than ten seconds at a time. If engine fails to start in ten seconds, wait 30 seconds and try again.

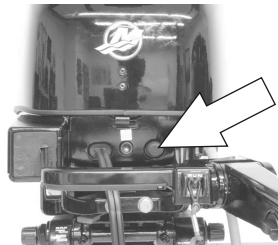

10187

8. Check for a steady stream of water flowing out of the water pump indicator hole.



9647

# OPERATION

**IMPORTANT:** If no water is coming out of the water pump indicator hole, stop engine and check cooling water intake for obstruction. No obstruction may indicate a water pump failure or blockage in the cooling system. These conditions will cause the engine to overheat. Have the outboard checked by your dealer. Operating the engine while overheated may cause serious engine damage.

## WARMING UP ENGINE

Before beginning operation, allow the engine to warm up at idling speed for three minutes.

## Gear Shifting

**IMPORTANT:** Never shift outboard into gear unless engine speed is at idle. Do not shift outboard into reverse when the engine is not running.

- Your outboard has three gear shift positions to provide operation: Forward (F), Neutral (N), and Reverse (R).
- **Tiller Handle Models** - Reduce engine speed to idle before shifting.

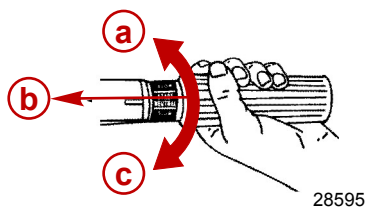

- a - (R) Reverse
- b - (N) Neutral
- c - (F) Forward

- **Remote Control Models** - When shifting, always stop at neutral position and allow the engine speed to return to idle.

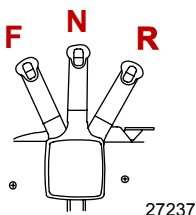

- Always shift outboard into gear with a quick motion.

# OPERATION

- After shifting outboard into gear, advance the remote control lever or rotate the throttle grip (tiller handle) to increase speed.

## Stopping the Engine

1. **Remote control models** - Reduce engine speed and shift outboard to neutral position. Turn ignition key to "OFF" position.

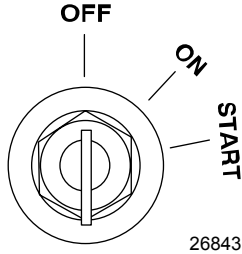

2. **Tiller handle models** - Reduce engine speed and shift outboard to neutral position. Push in the engine stop button or turn ignition key to "OFF" position.

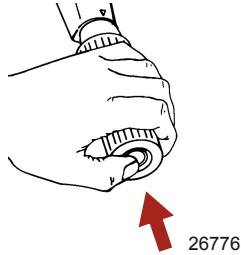

## Emergency Starting

If the starter system fails, use the spare starter rope (provided) and follow procedure.



# OPERATION

1. Remove flywheel cover or manual starter assembly.

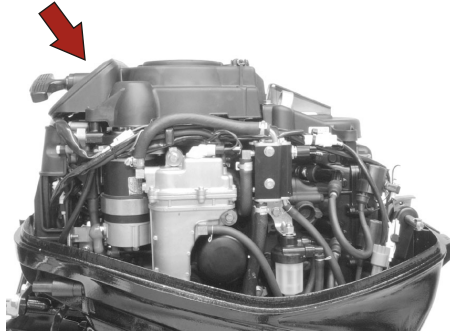

10004

2. Shift outboard to neutral ("N") position.

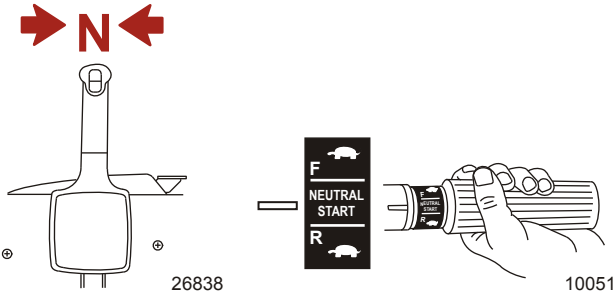

## ⚠ WARNING

The neutral-speed-protection device is inoperative when starting the engine with the emergency starter rope. Set the engine speed at idle and the gear shift in neutral to prevent the outboard from starting in gear.

3. Electric Start Models - Turn the ignition key to "ON" position.

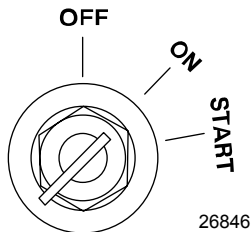

# OPERATION

## **⚠ WARNING**

High voltage is present any time the key is turned on, especially when starting or operating the engine. Do not touch ignition components or metal test probes and stay clear of spark plug leads when performing live tests.

## **⚠ WARNING**

The exposed moving flywheel can cause serious injury. Keep your hands, hair, clothing, tools, and other objects away from engine when starting or running the engine. Do not attempt to reinstall the flywheel cover or top cowl when engine is running.

4. Place the starter rope knot into the flywheel notch and wind the rope clockwise around the flywheel.
5. Pull the starter rope to start the engine.

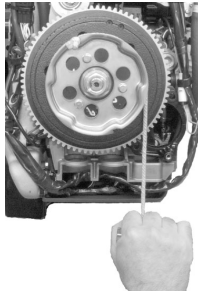

10006

# MAINTENANCE

## Outboard Care

To keep your outboard in the best operating condition, it is important that your outboard receive the periodic inspections and maintenance listed in the **Inspection and Maintenance Schedule**. We urge you to keep it maintained properly to ensure the safety of you and your passengers, and retain its dependability.

Record maintenance performed in the **Maintenance Log** at the back of this book. Save all maintenance work orders and receipts.

## SELECTING REPLACEMENT PARTS FOR YOUR OUTBOARD

We recommend using original Mercury Precision or Quicksilver replacement parts and Genuine Lubricants.

# MAINTENANCE

## EPA Emissions

### EMISSION CERTIFICATION LABEL

An emission certification label, showing emission levels and engine specifications directly related to emissions, is placed on the engine at time of manufacture.

The diagram shows a rectangular label with the Mercury logo on the left and the title "EMISSION CONTROL INFORMATION" on the right. The label contains several rows of text and input fields. Red circles with letters a through i are placed around the label, with arrows pointing to specific fields: a points to the idle speed field, b to the horsepower field, c to the piston displacement field, d to the date of manufacture field, e to the cold valve clearance field, f to the family number field, g to the maximum emission output field, h to the timing specification field, and i to the recommended spark plug and gap field.

<b>MERCURY</b>		<b>EMISSION CONTROL INFORMATION</b>	
THIS ENGINE CONFORMS TO <input type="checkbox"/> CALIFORNIA AND U.S. EPA EMISSION REGULATIONS FOR SPARK IGNITION MARINE ENGINES			
REFER TO OWNERS MANUAL FOR REQUIRED MAINTENANCE, SPECIFICATIONS, AND ADJUSTMENTS			
IDLE SPEED (in gear): <input type="text"/>		FAMILY: <input type="text"/>	
<input type="text"/> hp	<input type="text"/> cc	FEL: <input type="text"/> g/kWh	
TIMING (IN DEGREES): <input type="text"/>			
<input type="text"/>	SPARK PLUG: <input type="text"/>		← <b>i</b>
	GAP: <input type="text"/>		
COLD VALVE CLEARANCE (mm) <input type="text"/>	INTAKE: <input type="text"/>		
	EXHAUST: <input type="text"/>		

21096

- a** - Idle speed
- b** - Engine horsepower
- c** - Piston displacement
- d** - Date of manufacture
- e** - Valve clearance (if applicable)
- f** - Family number
- g** - Maximum emission output for the engine family
- h** - Timing specification
- i** - Recommended spark plug and gap

### OWNER RESPONSIBILITY

The owner/operator is required to have routine engine maintenance performed to maintain emission levels within prescribed certification standards.

The owner/operator is not to modify the engine in any manner that would alter the horsepower or allow emissions levels to exceed their predetermined factory specifications.

# MAINTENANCE

## Inspection and Maintenance Schedule

### BEFORE EACH USE

- Check engine oil level. See **Fuel and Oil - Checking and Adding Engine Oil**.
- Check that lanyard stop switch stops the engine.
- Visually inspect the fuel system for deterioration or leaks.
- Check outboard for tightness on transom.
- Check steering system for binding or loose components.
- Visually check steering link rod fasteners for proper tightness. See **Steering Link Rod Fasteners**.
- Check propeller blades for damage.

### AFTER EACH USE

- Flush out the outboard cooling system if operating in salt or polluted water. See **Flushing the Cooling System**.
- Wash off all salt deposits and flush out the exhaust outlet of the propeller and gearcase with fresh water if operating in saltwater.

### EVERY 100 HOURS OF USE OR ONCE YEARLY, WHICHEVER OCCURS FIRST

- Lubricate all lubrication points. Lubricate more frequently when used in saltwater. See **Lubrication Points**.
- Change engine oil and replace the oil filter. The oil should be changed more often when the engine is operated under adverse conditions such as extended trolling. See **Changing Engine Oil**.
- Replace spark plugs at first 100 hours or first year. After that, inspect spark plugs every 100 hours or once yearly. Replace spark plugs as needed. See **Spark Plug Inspection and Replacement**.
- Inspect thermostat visually for corrosion and broken spring. Make sure thermostat closes completely at room temperature.<sup>1</sup>
- Check engine low pressure fuel filter for contaminants. See **Fuel System**.

1. These items should be serviced by an authorized dealer.

# MAINTENANCE

- Replace the high pressure fuel filter.<sup>1</sup>
- Check engine timing setup.<sup>1</sup>
- Check corrosion control anodes. Check more frequently when used in saltwater. See **Corrosion Control Anode**.
- Drain and replace gear case lubricant. See **Gearcase Lubrication**.
- Lubricate splines on the driveshaft.<sup>1</sup>
- Check and adjust valve clearance, if necessary.<sup>1</sup>
- Check power trim fluid. See **Checking Power Trim Fluid**.
- Inspect battery. See **Battery Inspection**.
- Check control cable adjustments.<sup>1</sup>
- Inspect timing belt. See **Timing Belt Inspection**.
- Check tightness of bolts, nuts, and other fasteners.
- Check cowl seals to make sure seals are intact and not damaged.
- Check internal cowl sound reduction foam (if equipped) to make sure foam is intact and not damaged.
- Check that the intake silencer (if equipped) is in place.
- Check that the idle relief muffler (if equipped) is in place.
- Check for loose hose clamps and rubber boots (if equipped) on the air intake assembly.

## EVERY 300 HOURS OF USE OR THREE YEARS

- Replace water pump impeller (more often if overheating occurs or reduced water pressure is noted).<sup>1</sup>

## BEFORE PERIODS OF STORAGE

- Refer to Storage procedure. See **Storage** section.

## Flushing the Cooling System

Flush the internal water passages of the outboard with fresh water after each use in salt, polluted, or muddy water. This will help prevent a buildup of deposits from clogging the internal water passages.

# MAINTENANCE

Use a Mercury Precision or Quicksilver accessory (or equivalent) flushing attachment.

**IMPORTANT:** The engine must be run during flushing in order to open the thermostat and circulate water through the water passages.

## ⚠ WARNING

Rotating propellers can cause serious injury or death. Never operate the boat out of the water with a propeller installed. Before installing or removing a propeller, place the drive unit in neutral and engage the lanyard stop switch to prevent the engine from starting. Place a block of wood between the propeller blade and the anti-ventilation plate.

1. Remove propeller. Refer to **Propeller Replacement**. Install the flushing attachment so the rubber cups fit tightly over the cooling water intake.

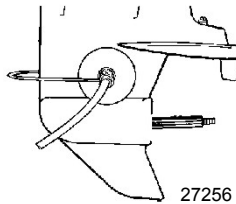

Flushing Device	91-44357Q 2
 9192	Attaches to the water intakes; provides a fresh water connection when flushing the cooling system or operating the engine.

# MAINTENANCE

2. Attach a water hose to the flushing attachment. Turn on the water and adjust the flow so water is leaking around the rubber cups to ensure the engine receives an adequate supply of cooling water.

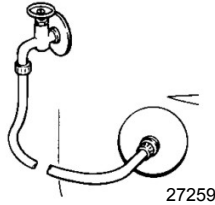

3. Start the engine and run it at idle speed in neutral shift position.

**IMPORTANT: Do not run engine above idle when flushing.**

4. Adjust water flow (if necessary) so excess water continues leaking out from around the rubber cups to ensure the engine is receiving an adequate supply of cooling water.

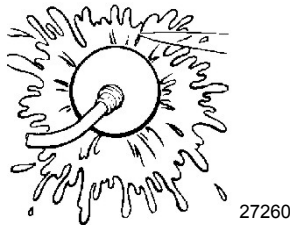

5. Check for a steady stream of water flowing out of the water pump indicator hole. Continue flushing the outboard for 3 to 5 minutes, carefully monitoring water supply at all times.
6. Stop the engine, turn off the water, and remove the flushing attachment. Reinstall the propeller.



# MAINTENANCE

## Top Cowl Removal and Installation

### REMOVAL

1. Unlock the rear latch by pulling lever up.



10190

2. Lift rear of cowl and disengage front hook.



10191

### INSTALLATION

1. Lower the top cowl over the engine. Bring the front of the cowl down first and engage the front hook, then lower the cowl into its seated position with the bottom cowl.
2. Apply some downward pressure on the bottom cowl and then lock the cowl in place by pushing in the cowl latch. Ensure the top cowl is securely fastened by pulling up on the back of the cowl.

### Exterior Care

Your outboard is protected with a durable baked enamel finish. Clean and wax often using marine cleaners and waxes.

# MAINTENANCE

## Battery Inspection

The battery should be inspected at periodic intervals to ensure proper engine starting capability.

**IMPORTANT: Read the safety and maintenance instructions which accompany your battery.**

1. Turn off the engine before servicing the battery.
2. Ensure the battery is secure against movement.
3. Battery cable terminals should be clean, tight, and correctly installed. Positive to positive and negative to negative.
4. Ensure the battery is equipped with a nonconductive shield to prevent accidental shorting of battery terminals.

## Fuel System

### WARNING

**Fuel is flammable and explosive. Ensure that the key switch is off and the lanyard is positioned so that the engine cannot start. Do not smoke or allow sources of spark or open flame in the area while servicing. Keep the work area well ventilated and avoid prolonged exposure to vapors. Always check for leaks before attempting to start the engine, and wipe up any spilled fuel immediately.**

Before servicing any part of the fuel system, stop engine and disconnect the battery. Drain the fuel system completely. Use an approved container to collect and store fuel. Wipe up any spillage immediately. Material used to contain spillage must be disposed of in an approved receptacle. Any fuel system service must be performed in a well ventilated area. Inspect any completed service work for sign of fuel leakage.

## FUEL LINE INSPECTION

Visually inspect the fuel line and primer bulb for cracks, swelling, leaks, hardness, or other signs of deterioration or damage. If any of these conditions are found, the fuel line or primer bulb must be replaced.

# MAINTENANCE

## FUEL FILTER (LOW PRESSURE)

Check the fuel filter for water accumulation or sediment. If water is in the fuel, remove the sight bowl and drain the water. If the filter appears to be contaminated, remove and replace.

### REMOVAL

1. Read **Fuel System** servicing information and **Warning**, preceding.
2. Pull out the filter assembly from mount. Hold on to the cover to prevent it from turning and remove the sight bowl. Empty contents into an approved container.
3. Pull out the filter element and replace it if necessary.

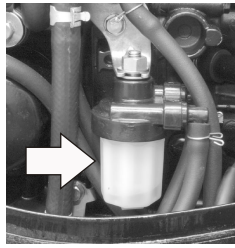
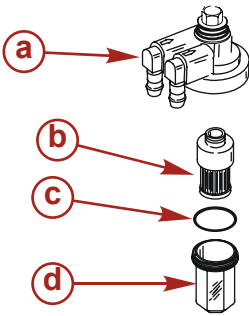

9694

- a** - Cover
- b** - Filter element
- c** - O-ring seal
- d** - Sight bowl

### INSTALLATION

1. Push the filter element into the cover.
2. Place the O-ring seal into its proper position on the sight bowl and screw the sight bowl hand-tight into the cover.
3. Push filter assembly back into mount.

**IMPORTANT:** Visually inspect for fuel leakage from the filter by squeezing the primer bulb until firm, forcing fuel into the filter.

# MAINTENANCE

## Steering Link Rod Fasteners

**IMPORTANT:** The steering link rod that connects the steering cable to the engine must be fastened using the steering link rod fastening hardware supplied with engine. Never replace the locknuts (11-16147--3) with common nuts (non-locking) as they will work loose and vibrate off, freeing the link rod to disengage.

### **WARNING**

Improper fasteners or improper installation procedures can result in loosening or disengagement of the steering link rod. This can cause a sudden, unexpected loss of boat control, resulting in serious injury or death due to occupants being thrown within or out of the boat. Always use required components and follow instructions and torque procedures.

Assemble steering link rod to steering cable with flat washer and nylon insert locknut. Tighten locknut until it seats, then back nut off 1/4 turn.

# MAINTENANCE

Assemble steering link rod to engine with bolt, locknut, spacer, and flat washers. Torque locknut to specifications.

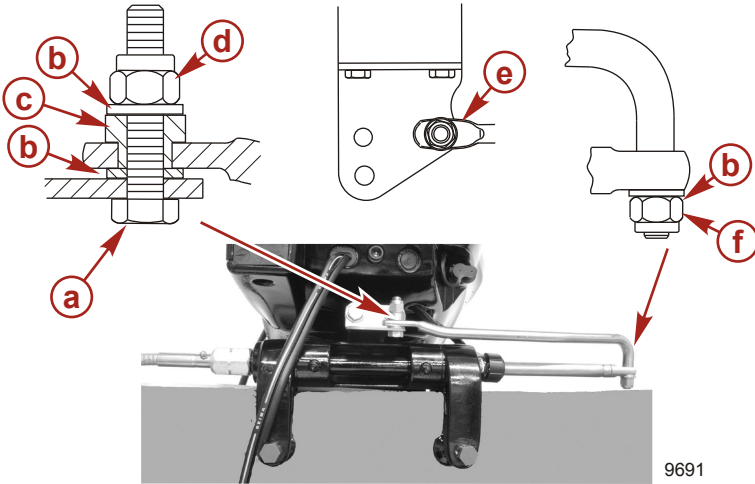

- a** - Bolt (10-898101018)
- b** - Flat washer (12-95392-10)
- c** - Spacer (23-853826001)
- d** - Nylon insert locknut (11-16147--3)
- e** - Install steering link rod into side hole
- f** - Nylon insert locknut (11-16147--3) (tighten until it seats, then back off 1/4 turn)

Description	Nm	lb. in.	lb. ft.
Nylon insert locknut "d"	27		20
Nylon insert locknut "f"	Tighten until it seats, then back off ¼ turn		

## Corrosion Control Anode

Your outboard has corrosion control anodes at different locations. An anode helps protect the outboard against galvanic corrosion by sacrificing its metal to be slowly corroded instead of the outboard metals.

# MAINTENANCE

Each anode requires periodic inspection, especially in saltwater which will accelerate the erosion. To maintain this corrosion protection, always replace the anode before it is completely eroded. Never paint or apply a protective coating on the anode as this will reduce effectiveness of the anode.

One anode is installed in the engine block. Remove anode at location shown. Install anode to cover with bolt. Tighten bolt to specified torque. Reinstall cover with new gasket. Tighten bolts to specified torque.

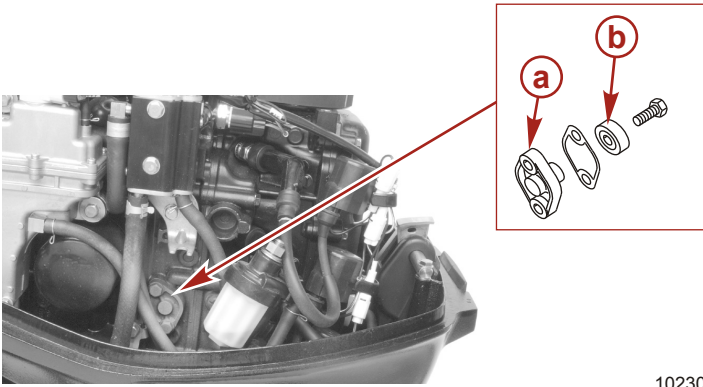

10230

- a** - Cover
- b** - Anode

Description	Nm	lb. in.	lb. ft.
Anode bolt	6	53	
Cover bolt (2)	6	53	

# MAINTENANCE

The second anode is the trim tab and the third anode is installed on the transom brackets.

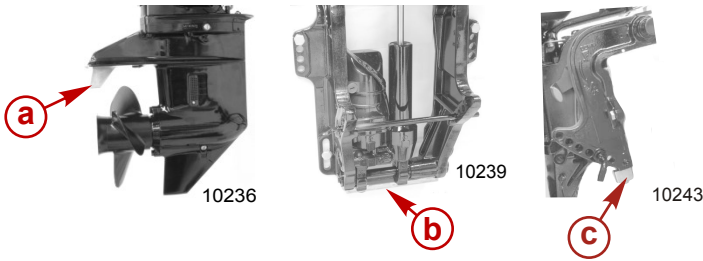

- a** - Trim tab
- b** - Transom bracket anode - long
- c** - Transom bracket anode - short

## Propeller Replacement

### ⚠ WARNING

Rotating propellers can cause serious injury or death. Never operate the boat out of the water with a propeller installed. Before installing or removing a propeller, place the drive unit in neutral and engage the lanyard stop switch to prevent the engine from starting. Place a block of wood between the propeller blade and the anti-ventilation plate.

1. Shift outboard to neutral (N) position.

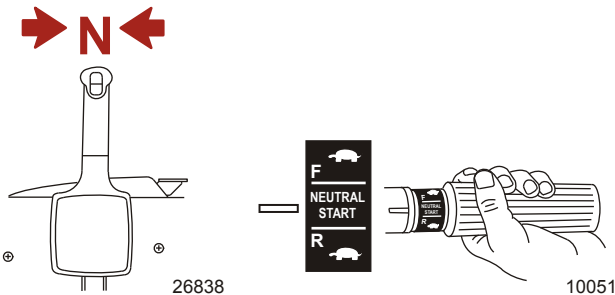

**IMPORTANT:** Refer to Spark Plug Inspection and Replacement for removing spark plug leads.

# MAINTENANCE

2. Remove spark plug leads to prevent engine from starting.

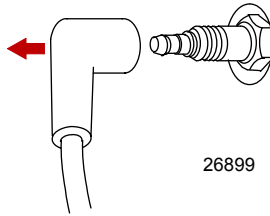

3. Straighten and remove cotter pin.
4. Place a block of wood between gearcase and propeller to hold propeller and remove propeller nut.
5. Pull propeller straight off shaft. If propeller is seized to the shaft and cannot be removed, have the propeller removed by an authorized dealer.

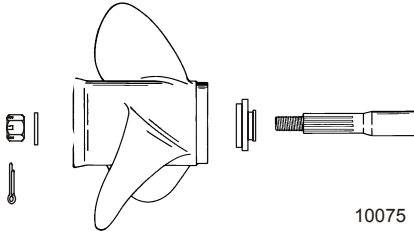
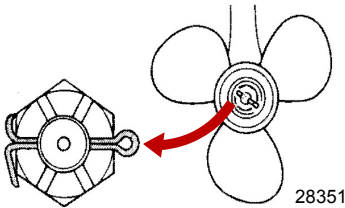

**IMPORTANT:** To prevent the propeller hub from corroding and seizing to the propeller shaft (especially in salt water), always apply a coat of the recommended lubricant to the entire propeller shaft at the recommended maintenance intervals and also each time the propeller is removed.



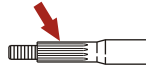

# MAINTENANCE

- Coat the propeller shaft with Quicksilver or Mercury Precision Lubricants Anti-Corrosion Grease or 2-4-C with PTFE.



10087

Tube Ref No.	Description	Where Used	Part No.
 94	Anti-Corrosion Grease	Propeller shaft	92-802867Q 1
 95	2-4-C with PTFE	Propeller shaft	92-802859A 1

- Install front thrust hub, propeller, rear thrust hub washer and propeller nut onto the shaft.

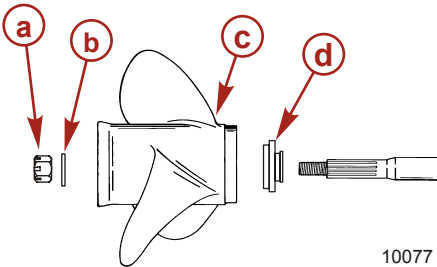

- a** - Propeller nut
- b** - Rear thrust washer
- c** - Propeller
- d** - Forward thrust hub

10077

- Place a block of wood between gearcase and propeller and torque propeller nut to specification.

**NOTE:** If the propeller nut does not align with the propeller shaft hole after tightening to the specified torque, then tighten the nut further to align it with the hole.

# MAINTENANCE

- Align the propeller nut with the propeller shaft hole. Insert a new cotter pin in the hole and bend the cotter pin ends.

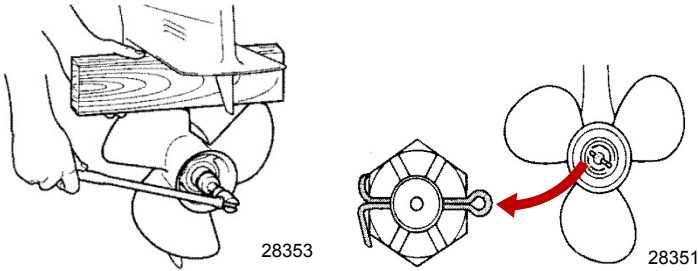

Description	Nm	lb. in.	lb. ft.
Propeller nut	25		18

- Install the spark plug leads.

## Spark Plug Inspection and Replacement

### **⚠ WARNING**

Damaged spark plug boots may emit sparks which can ignite fuel vapors under the engine cowl, resulting in serious injury or death from a fire or explosion. To avoid damaging the spark plug boots, do not use any sharp object or metal tool to remove the spark plug boots.

- Remove the spark plug leads. Twist the rubber boots slightly and pull off.

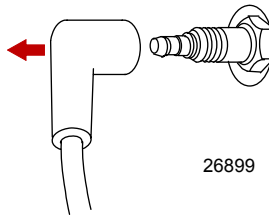

# MAINTENANCE

- Remove the spark plugs to inspect. Replace spark plug if electrode is worn or the insulator is rough, cracked, broken, blistered, or fouled.

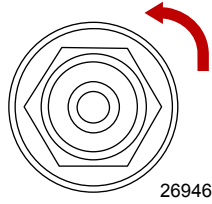

- Set the spark plug gap to specifications.

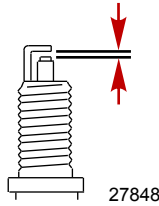

Spark Plug Gap	
Spark plug	0.80–0.90 mm (0.031–0.035 in.)

- Before installing spark plugs, clean off any dirt on the spark plug seats. Install plugs finger-tight, and then tighten to the specified value.

Description	Nm	lb. in.	lb. ft.
Spark plug	20		14

## Fuse Replacement - Electric Start Models

**IMPORTANT:** Always carry spare SFE 20 amp fuses.

The electric starting circuit is protected from overload by an SFE 20 amp fuse. If the fuse is blown, the electric starter motor will not operate. Try to locate and correct the cause of the overload. If the cause is not found, the fuse may blow again.

# MAINTENANCE

Open the fuse holder and look at the silver colored band inside the fuse. If band is broken, replace the fuse. Replace fuse with a new fuse with the same rating.

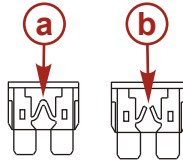
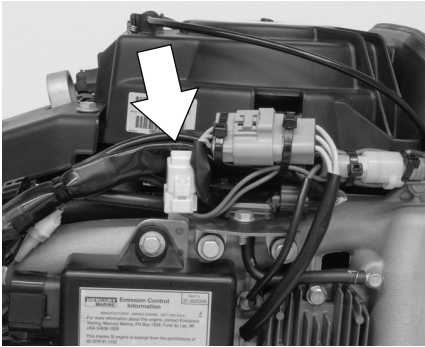

15917

**a** - Good fuse

**b** - Blown fuse

## Timing Belt Inspection

Inspect the timing belt and have it replaced by an authorized dealer if any of the following conditions are found.

- Cracks in the back of the belt or in the base of the belt teeth.
- Excessive wear at the roots of the cogs.
- Rubber portion swollen by oil.
- Belt surfaces roughened.
- Signs of wear on edges or outer surfaces of belt.

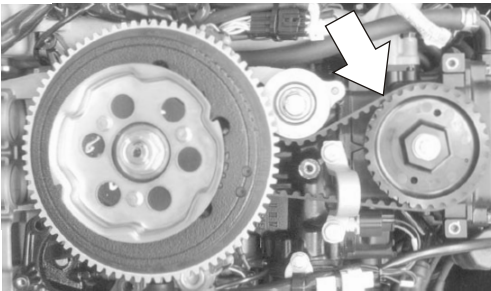



9697

# MAINTENANCE

## Lubrication Points



1. Lubricate the following with Quicksilver or Mercury Precision Lubricants Anti-Corrosion Grease or 2-4-C with PTFE.

Tube Ref No.	Description	Where Used	Part No.
 94	Anti-Corrosion Grease	Propeller shaft	92-802867Q 1
 95	2-4-C with PTFE	Propeller shaft	92-802859A 1

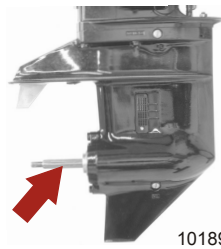
- Propeller Shaft - Refer to **Propeller Replacement** for removal and installation of the propeller. Coat the entire propeller shaft with lubricant to prevent the propeller hub from corroding and seizing to the shaft.



2. Lubricate the following with Quicksilver or Mercury Precision Lubricants 2-4-C with PTFE or Special Lubricant 101.

Tube Ref No.	Description	Where Used	Part No.
 34	Special Lubricant 101	Swivel bracket, tilt tube, transom clamp screws, steering cable grease fitting	92-802865Q02
 95	2-4-C with PTFE	Swivel bracket, tilt tube, transom clamp screws, steering cable grease fitting	92-802859A 1

# MAINTENANCE

- Swivel Bracket - Lubricate through fitting.

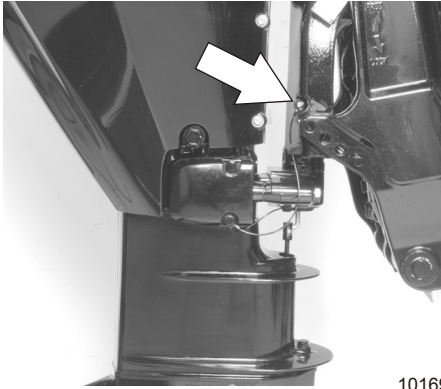

10169

- Tilt Tube - Lubricate through fittings.

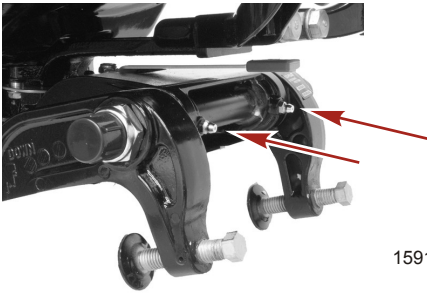

15915

- Lubricate threads on transom clamp screws (if equipped).

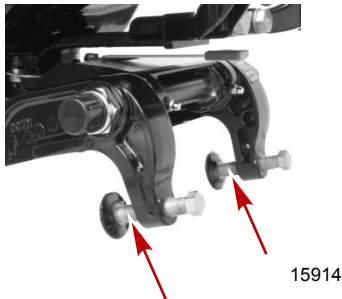

15914

# MAINTENANCE

- Steering Cable Grease Fitting (If equipped) - Rotate steering wheel to fully retract the steering cable end into the outboard tilt tube. Lubricate through fitting.

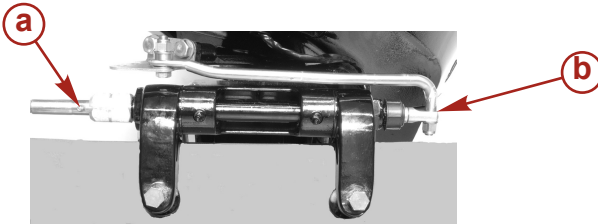

10161

- a** - Fitting
- b** - Steering cable end

## ⚠ WARNING

Incorrect cable lubrication can cause hydraulic lock, leading to serious injury or death from loss of boat control. Completely retract the end of the steering cable before applying lubricant.

3. Lubricate the following with light weight oil.
  - Steering Link Rod Pivot Points - Lubricate pivot points.

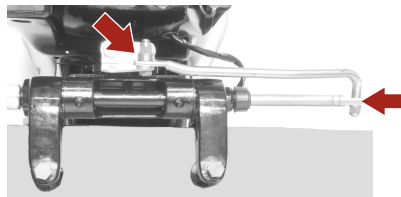

10164

# MAINTENANCE

## Checking Power Trim Fluid

1. Tilt outboard to the full up position and engage the tilt support lock.



9703

2. Remove fill cap and check fluid level. The fluid level should be even with the bottom of the fill hole. Add Quicksilver or Mercury Precision Lubricants Power Trim & Steering Fluid. If not available, use automotive (ATF) automatic transmission fluid.

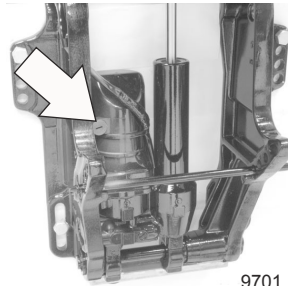

9701

Tube Ref No.	Description	Where Used	Part No.
 114	Power Trim and Steering Fluid	Power trim system	92-858074K01

## Changing Engine Oil

### ENGINE OIL CAPACITY

Engine oil capacity is approximately 1.8 liter (1.9 quarts).



# MAINTENANCE

## OIL CHANGING PROCEDURE

1. Tilt the outboard up to the trailer position.
2. Turn the steering on the outboard so that the drain hole is facing downward. Remove drain plug and drain engine oil into an appropriate container. Lubricate the seal on the drain plug with oil and reinstall.

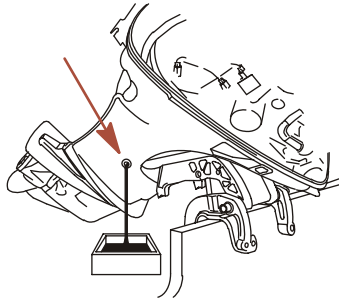

15916

## CHANGING OIL FILTER

1. Place a rag or towel below the oil filter to absorb any spilled oil.
2. Unscrew old filter by turning the filter to the left.

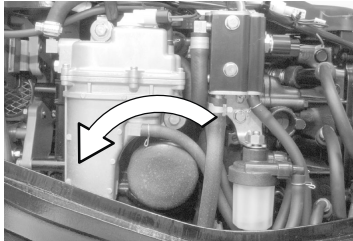

9735

3. Clean the mounting base. Apply film of clean oil to filter gasket. Do not use grease. Screw new filter on until gasket contacts base, then tighten  $\frac{3}{4}$  to 1 turn.

## OIL FILLING

1. Remove the oil fill cap and add oil to proper operating level.

# MAINTENANCE

2. Idle engine for five minutes and check for leaks. Stop engine and check oil level on dipstick. Add oil if necessary.

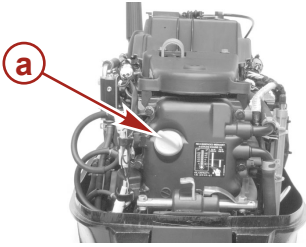

**a** - Oil fill cap

9737

## Gearcase Lubrication

When adding or changing gearcase lubricant, visually check for the presence of water in the lubricant. If water is present, it may have settled to the bottom and will drain out prior to the lubricant, or it may be mixed with the lubricant, giving it a milky colored appearance. If water is noticed, have the gearcase checked by your dealer. Water in the lubricant may result in premature bearing failure or, in freezing temperatures, will turn to ice and damage the gearcase.

Examine the drained gearcase lubricant for metal particles. A small amount of metal particles indicates normal gear wear. An excessive amount of metal filings or larger particles (chips) may indicate abnormal gear wear and should be checked by an authorized dealer.

## DRAINING GEARCASE

1. Place outboard in a vertical operating position.
2. Place drain pan below outboard.

# MAINTENANCE

3. Remove vent plug and fill/drain plug and drain lubricant.

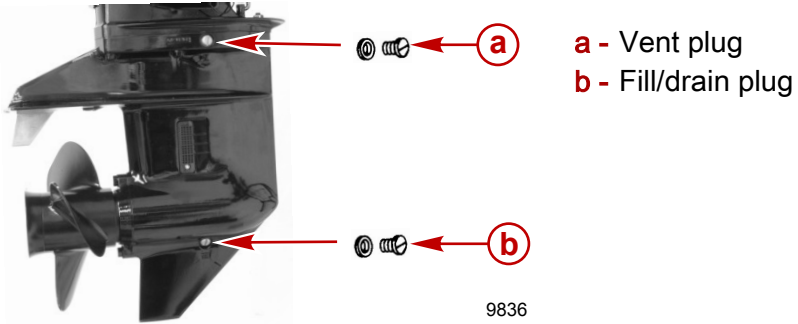

## GEARCASE LUBRICANT CAPACITY

Gearcase lubricant capacity is approximately 350 ml (11.8 fl oz).

## GEARCASE LUBRICANT RECOMMENDATION

Mercury or Quicksilver Premium or High Performance Gear Lubricant.

## CHECKING LUBRICANT LEVEL AND REFILLING GEARCASE

1. Place outboard in a vertical operating position.
2. Remove vent plug.
3. Remove drain plug. Place lubricant tube into the fill hole and add lubricant until it appears at the vent hole.

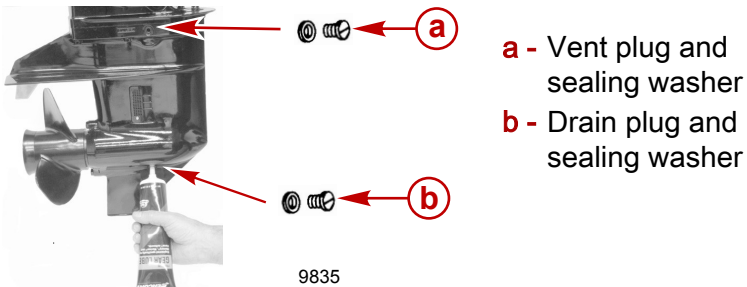

**IMPORTANT: Replace sealing washers if damaged.**

4. Stop adding lubricant. Install the vent plug and sealing washer before removing the lubricant tube.
5. Remove lubricant tube and install cleaned fill/drain plug and sealing washer.

# MAINTENANCE

## Submerged Outboard

A submerged outboard will require service within a few hours by an authorized dealer once the outboard is recovered from the water. This immediate attention by a servicing dealer is necessary once the engine is exposed to the atmosphere to minimize internal corrosion damage to the engine.

# STORAGE

## Storage Preparation

The major consideration in preparing your outboard for storage is to protect it from rust, corrosion, and damage caused by freezing of trapped water.

The following storage procedures should be followed to prepare your outboard for out of season storage or prolonged storage (two months or longer).

### *NOTICE*

**Without sufficient cooling water, the engine, the water pump, and other components will overheat and suffer damage. Provide a sufficient supply of water to the water inlets during operation.**

## FUEL SYSTEM

**IMPORTANT:** Gasoline containing alcohol (ethanol or methanol) can cause a formation of acid during storage and can damage the fuel system. If the gasoline being used contains alcohol, it is advisable to drain as much of the remaining gasoline as possible from the fuel tank, remote fuel line, and engine fuel system.

Fill the fuel tank and engine fuel system with treated (stabilized) fuel to help prevent formation of varnish and gum. Proceed with the following instructions.

- Portable fuel tank - Pour the required amount of gasoline stabilizer (follow instructions on container) into fuel tank. Tip fuel tank back and forth to mix stabilizer with the fuel.
- Permanently installed fuel tank - Pour the required amount of gasoline stabilizer (follow instructions on container) into a separate container and mix with approximately 1 liter (1 U.S. quart) of gasoline. Pour this mixture into fuel tank.
- Place the outboard in water or connect flushing attachment for circulating cooling water. Run the engine for ten minutes to fill the engine fuel system.

# STORAGE

Flushing Device	91-44357Q 2
 9192	Attaches to the water intakes; provides a fresh water connection when flushing the cooling system or operating the engine.

## Protecting External Outboard Components

- Lubricate all outboard components listed in **Maintenance - Inspection and Maintenance Schedule**.
- Touch up any paint nicks. See your dealer for touch-up paint.
- Spray Quicksilver or Mercury Precision Lubricants Corrosion Guard on external metal surfaces (except corrosion control anodes).

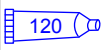
Tube Ref No.	Description	Where Used	Part No.
 120	Corrosion Guard	External metal surfaces	92-802878 55

## Protecting Internal Engine Components

- Remove the spark plugs and inject a small amount of engine oil inside of each cylinder.
- Rotate the flywheel manually several times to distribute the oil in the cylinders. Reinstall spark plugs.
- Change the engine oil.

## Gearcase

- Drain and refill the gearcase lubricant (refer to **Gearcase Lubrication**).

## Positioning Outboard for Storage

Store outboard in an upright (vertical) position to allow water to drain out of the outboard.

# STORAGE

## *NOTICE*

Storing the outboard in a tilted position can damage the outboard. Water trapped in the cooling passages or rain water collected in the propeller exhaust outlet in the gearcase can freeze. Store the outboard in the full down position.

### **Battery Storage**

- Follow the battery manufacturer's instructions for storage and recharging.
- Remove the battery from the boat and check water level. Recharge if necessary.
- Store the battery in a cool, dry place.
- Periodically check the water level and recharge the battery during storage.

# TROUBLESHOOTING

## Starter Motor Will Not Crank the Engine (Electric Start Models)

### POSSIBLE CAUSES

- Blown fuse in the starting circuit. Refer to **Maintenance** section.
- Outboard is not shifted to neutral position.
- Weak battery or battery connections are loose or corroded.
- Ignition key switch failure.
- Wiring or electrical connection faulty.
- Starter motor or starter solenoid failure.

## Engine Will Not Start

### POSSIBLE CAUSES

***NOTE:** If the outboard has run out of fuel, or has been in storage for an extended period of time, additional attempts to start the engine will be required to purge the fuel system of air.*

- Lanyard stop switch not in "RUN" position.
- Incorrect starting procedure. Refer to **Operation** section.
- Old or contaminated gasoline.
- Engine flooded. Refer to **Operation** section.
- Fuel is not reaching the engine.
  - Fuel tank is empty.
  - Fuel tank vent not open or restricted.
  - Fuel line is disconnected or kinked.
  - Primer bulb not squeezed.
  - Primer bulb check valve is faulty.
  - Fuel filter is obstructed. Refer to **Maintenance** section.
  - Fuel pump failure.
  - Fuel tank filter obstructed.
- Open 20 Amp fuse. Refer to **Maintenance** section.
- Ignition system component failure.
- Wiring or electrical connection faulty.



# TROUBLESHOOTING

- Spark plugs fouled or defective. Refer to **Maintenance** section.

## Engine Runs Erratically

### POSSIBLE CAUSES

- Overheating - Warning horn not working.
- Low oil pressure. Check oil level.
- Spark plugs fouled or defective. Refer to **Maintenance** section.
- Incorrect setup and adjustments.
- Fuel is being restricted to the engine.
  - a. Engine fuel filter is obstructed. Refer to **Maintenance** section.
  - b. Fuel tank filter obstructed.
  - c. Stuck anti-siphon valve located on permanently built-in type fuel tanks.
  - d. Fuel line is kinked or pinched.
- Fuel pump failure.
- Ignition system component failure.

## Performance Loss

### POSSIBLE CAUSES

- Low oil pressure. Check oil level.
- Throttle not fully open.
- Damaged or improper size propeller.
- Incorrect engine timing, adjustments, or setup.
- Boat overloaded or load improperly distributed.
- Excessive water in bilge.
- Boat bottom is dirty or damaged.

## Battery Will Not Hold Charge

### POSSIBLE CAUSES

- Battery connections are loose or corroded.
- Low electrolyte level in battery.

# TROUBLESHOOTING

- Worn out or inefficient battery.
- Excessive use of electrical accessories.
- Defective rectifier, alternator, or voltage regulator.

# OWNER SERVICE ASSISTANCE

## Local Repair Service

Always return your outboard to your local authorized dealer should the need for service arise. Only he has the factory trained mechanics, knowledge, special tools, equipment, and genuine parts and accessories to properly service your engine should the need occur. He knows your engine best.

## Service Away from Home

If you are away from your local dealer and the need arises for service, contact the nearest authorized dealer. Refer to the Yellow Pages of the telephone directory. If, for any reason, you cannot obtain service, contact the nearest Mercury Marine Service Office.

## Parts and Accessories Inquiries

All inquiries concerning genuine replacement parts and accessories should be directed to your local authorized dealer. The dealer has the necessary information to order parts and accessories for you. When inquiring on parts and accessories, the dealer requires the model and serial number to order the correct parts.

## Service Assistance

Your satisfaction with your outboard product is very important to your dealer and to us. If you ever have a problem, question or concern about your outboard product, contact your dealer or any authorized Mercury Marine dealership. If additional assistance is required, take these steps.

1. Talk with the dealership's sales manager or service manager. If this has already been done, then contact the owner of the dealership.
2. Should you have a question, concern, or problem that cannot be resolved by your dealership, please contact Mercury Marine Service Office for assistance. Mercury Marine will work with you and your dealership to resolve all problems.

The following information will be needed by the service office:

# OWNER SERVICE ASSISTANCE

- Your name and address
- Daytime telephone number
- Model and serial number of your outboard
- The name and address of your dealership
- Nature of problem

## Mercury Marine Service Offices

For assistance, call, fax, or write. Please include your daytime telephone number with mail and fax correspondence.

<b>United States, Canada</b>		
Telephone	English - (920) 929-5040 Français - (905) 636-4751	Mercury Marine W6250 W. Pioneer Road P.O. Box 1939 Fond du Lac, WI 54936-1939
Fax	English - (920) 929-5893 Français - (905) 636-1704	
Website	www.mercurymarine.com	

<b>Australia, Pacific</b>		
Telephone	(61) (3) 9791-5822	Brunswick Asia Pacific Group 41-71 Bessemer Drive Dandenong South, Victoria 3175 Australia
Fax	(61) (3) 9706-7228	

<b>Europe, Middle East, Africa</b>		
Telephone	(32) (87) 32 • 32 • 11	Brunswick Marine Europe Parc Industriel de Petit-Rechain B-4800 Verviers, Belgium
Fax	(32) (87) 31 • 19 • 65	

<b>Mexico, Central America, South America, Caribbean</b>		
Telephone	(954) 744-3500	Mercury Marine 11650 Interchange Circle North Miramar, FL 33025 U.S.A.
Fax	(954) 744-3535	

<b>Japan</b>		
Telephone	072-233-8888	Kisaka Co., Ltd. 4-130 Kannabecho Sakai-shi Sakai-ku 5900984 Osaka, Japan
Fax	072-233-8833	

# OWNER SERVICE ASSISTANCE

<b>Asia, Singapore</b>		
Telephone	(65) 65466160	Brunswick Asia Pacific Group T/A Mercury Marine Singapore Pte Ltd 29 Loyang Drive Singapore, 508944
Fax	(65) 65467789	

# INSTALLATION

## Installation Information

### BOAT HORSEPOWER CAPACITY

#### WARNING

Exceeding the boat's maximum horsepower rating can cause serious injury or death. Overpowering the boat can affect boat control and flotation characteristics or break the transom. Do not install an engine that exceeds the boat's maximum power rating.

Do not overpower or overload your boat. Most boats will carry a required capacity plate indicating the maximum acceptable power and load as determined by the manufacturer following certain federal guidelines. If in doubt, contact your dealer or the boat manufacturer.

U.S. COAST GUARD CAPACITY	
MAXIMUM HORSEPOWER	XXX
MAXIMUM PERSON CAPACITY (POUNDS)	XXX
MAXIMUM WEIGHT CAPACITY	XXX

26777

### START IN GEAR PROTECTION

#### WARNING

Starting the engine with the drive in gear can cause serious injury or death. Never operate a boat that does not have a neutral-safety-protection device.

The remote control connected to the outboard must be equipped with a start in neutral only protection device. This prevents the engine from starting in gear.

# INSTALLATION

## SELECTING ACCESSORIES FOR YOUR OUTBOARD

Genuine Mercury Precision or Quicksilver Accessories have been specifically designed and tested for your outboard. These accessories are available from Mercury Marine dealers.

**IMPORTANT: Check with your dealer before installing accessories. The misuse of approved accessories or the use of nonapproved accessories can damage the product.**

Some accessories not manufactured or sold by Mercury Marine are not designed to be safely used with your outboard or outboard operating system. Acquire and read the installation, operation and maintenance manuals for all your selected accessories.

## LOW PERMEATION FUEL HOSE REQUIREMENT

Required for outboards manufactured for sale, sold, or offered for sale in the United States.

- The Environmental Protection Agency (EPA) requires that any outboard manufactured after January 1, 2009 must use low permeation fuel hose for the primary fuel hose connecting the fuel tank to the outboard.
- Low permeation hose is USCG Type B1-15 or Type A1-15, defined as not exceeding  $15/\text{gm}^2/24 \text{ h}$  with CE 10 fuel at  $23 \text{ }^\circ\text{C}$  as specified in SAE J 1527 - marine fuel hose.

## ELECTRIC FUEL PUMP

If an electric fuel pump is used, the fuel pressure must not exceed 27.58 kPa (4 psi) at the engine. If necessary, install a pressure regulator to regulate the pressure.

# INSTALLATION

## Installing Outboard

### INSTALLATION SPECIFICATIONS

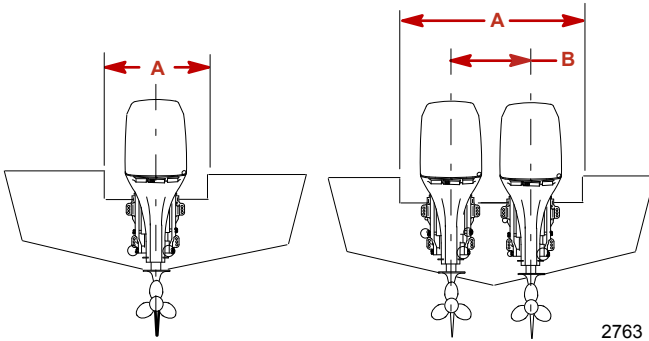

**a** - Minimum transom opening

**b** - Engine center line for dual engines

Minimum Transom Opening	
Single engine (remote)	48.3 cm (19 in.)
Single engine (tiller)	76.2 cm (30 in.)
Dual engines	101.6 cm (40 in.)

Engine Center Line	
Minimum	66 cm (26 in.)

### TOP COWL REMOVAL AND INSTALLATION

#### Top Cowl Removal

1. Unlock the cowl latch located at the rear of the engine by lifting the latch up.



# INSTALLATION

2. Lift up on the rear of the cowl and disengage the front hook.

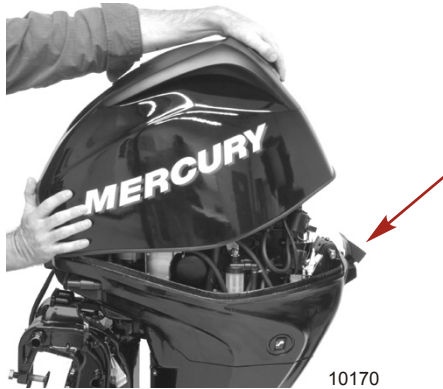

## Top Cowl Installation

1. Engage the front hook and push the top cowl onto the lower cowl.
2. Push the cowl latch down to lock the cowl in place.

## LIFTING OUTBOARD

Use the lifting eye located aft of the flywheel to support the engine when installing the outboard.

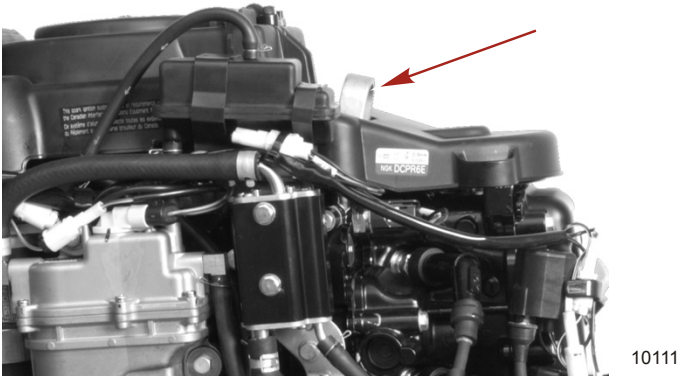

# INSTALLATION

## INSTALLING THE OUTBOARD ON THE TRANSOM (MANUAL TILT MODELS)

**IMPORTANT:** Models not equipped with power trim or gas assist must have the transom clamps contacting the top of the transom, and the clamp screws tightened, prior to drilling the mounting bolt holes through the transom.

1. Place outboard on centerline of transom.

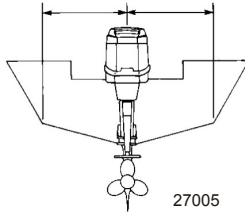

2. Tighten the transom clamp bolts.

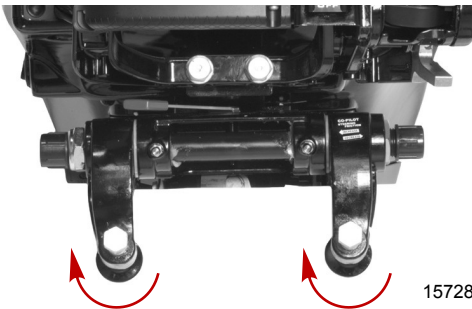

3. Use a long drill bit to drill the two lower 8 mm (0.315 in.) holes through the transom using the transom clamps as a template for the bolt hole pattern.

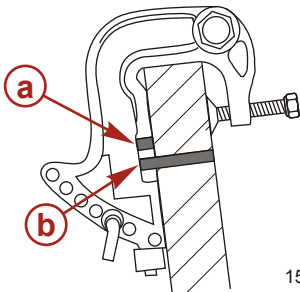

- a** - Upper transom clamp hole
- b** - Lower transom clamp hole

# INSTALLATION

4. Apply marine sealer to shanks of bolts. Do not apply marine sealer to the threads of the bolts.
5. Secure the engine to the transom with the mounting hardware supplied with the engine. Tighten mounting hardware securely.

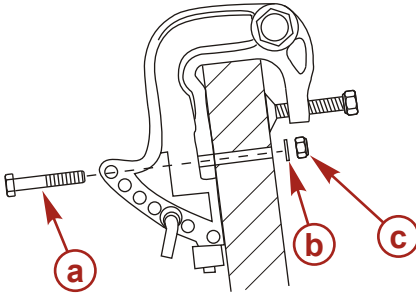

15729

- a - Bolt (2)
- b - Washer (2)
- c - Locknut (2)

## INSTALLING THE OUTBOARD ON THE TRANSOM (POWER TRIM AND GAS ASSIST)

**IMPORTANT:** Determine the strength of the boat transom. The outboard mounting locknuts and bolts should be able to hold 75 Nm (55 lb. ft.) of torque without the boat transom yielding or cracking. If the boat transom yields or cracks under this torque, the construction of the transom may not be adequate. The boat transom must be strengthened or the load carrying area increased.

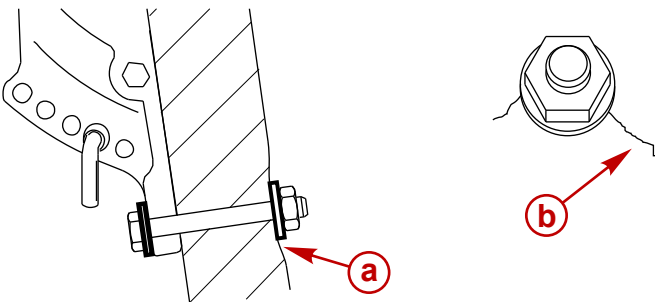

18961

- a - Transom yielding under bolt torque
- b - Transom cracking under bolt torque

# INSTALLATION

When first determining transom strength, use a dial torque wrench. If the bolt or nut continues to turn without the torque reading on the dial increasing, it is an indication that the transom is yielding. The load area can be increased by using a larger washer or a transom reinforcement plate.

**NOTE:** *The inside holes on the transom reinforcement plate are for the lower transom bolts and the outside holes are for the upper transom bolts.*

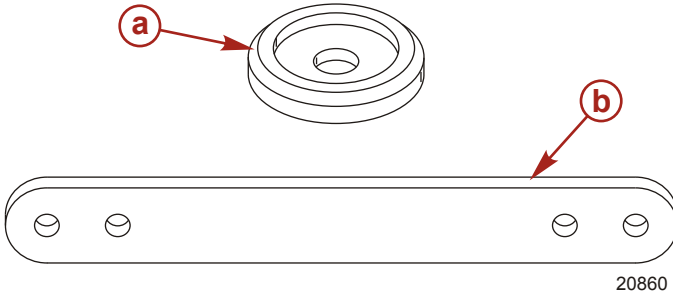

- a** - Large transom washer
- b** - Transom reinforcement plate

Description	Part Number
Large transom washer	67-896392
Transom reinforcement plate	67-896305

# INSTALLATION

1. Use the transom drilling fixture for drilling the transom mounting holes.

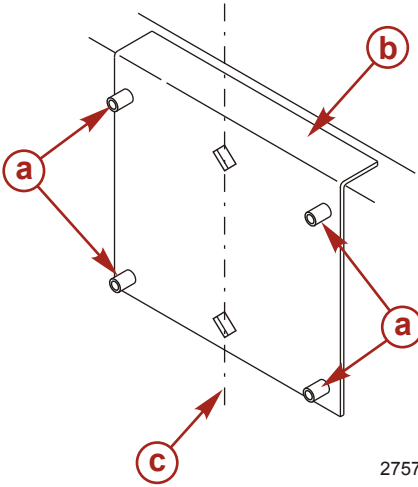

- a** - Drill guide holes
- b** - Transom drilling fixture
- c** - Transom centerline

2757

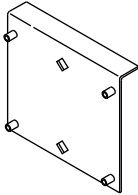
Transom Drilling Fixture	91-98234A2
 <p>5489</p>	Aids in engine installation by acting as a template for engine mounting holes.

2. Drill four 13.5 mm (17/32 in.) mounting holes.

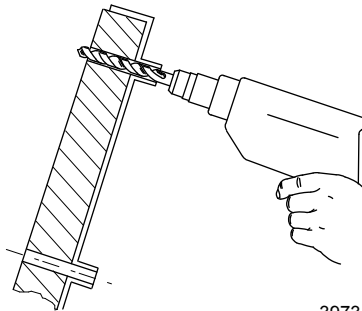

3973

# INSTALLATION

3. Install the outboard so that the anti-ventilation plate is in-line or within 25 mm (1 in.) of the bottom of the boat.

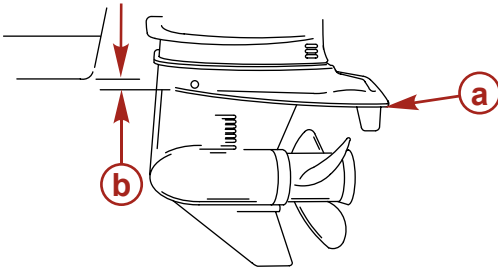

- a** - Anti-ventilation plate
- b** - In-line or within 25 mm (1 in.)

8045

4. Apply marine sealer to shanks of bolts. Do not apply marine sealer to the threads of the bolts.
5. Fasten outboard with provided mounting hardware shown. Tighten the locknuts to the specified torque.

The outboard must be secured to the transom with the two transom bracket clamp screws and four 13 mm (1/2 in.) diameter mounting bolts and locknuts provided. Install two bolts through the upper set of mounting holes and two bolts through the lower set of mounting slots.

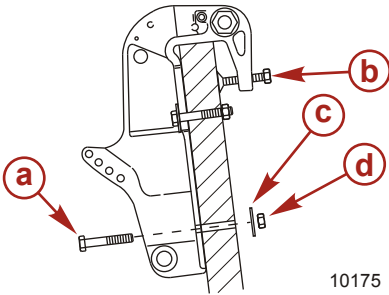

- a** - Bolt (4)
- b** - Transom clamp bolt
- c** - Washer (4)
- d** - Locknut (4)

10175

Description	Nm	lb. in.	lb. ft.
Outboard mounting locknuts and bolts	75		55

## STEERING BRACKET, STEERING CABLE INSTALLATION

1. Install the steering bracket with two washers and two 30 x 80 mm bolts. Tighten the steering bracket bolts to the specified torque.

# INSTALLATION

- Lubricate entire steering cable end with 2-4-C with PTFE.

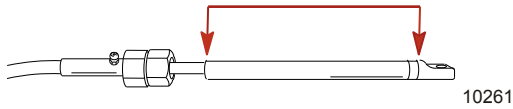

Tube Ref No.	Description	Where Used	Part No.
 95	2-4-C with PTFE	Steering cable end	92-802859A 1

- Install the steering cable seal onto the tilt tube.
- Install the steering cable and tighten the steering cable nut to the specified torque.

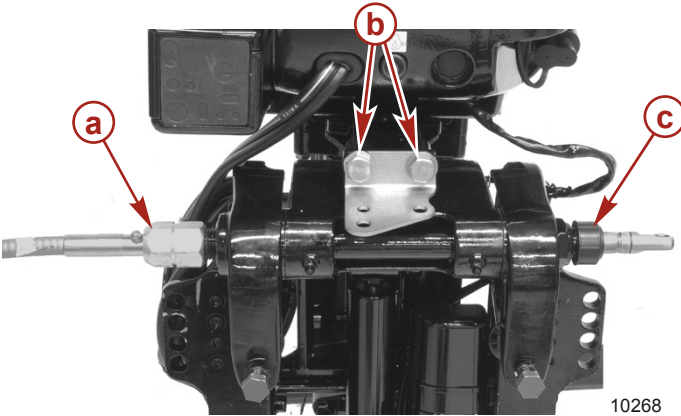

- a** - Steering cable nut
- b** - Steering bracket bolt and washer (2)
- c** - Steering cable seal

Description	Nm	lb. in.	lb. ft.
Steering cable nut	47.5		35
Steering bracket bolt	30		22.13

# INSTALLATION

## STEERING LINK ROD FASTENERS

**IMPORTANT:** The steering link rod that connects the steering cable to the engine must be fastened using the steering link rod fastening hardware supplied with engine. Never replace the locknuts (11-16147-3) with common nuts (non-locking) as they will work loose and vibrate off, freeing the link rod to disengage.

### **WARNING**

Improper fasteners or improper installation procedures can result in loosening or disengagement of the steering link rod. This can cause a sudden, unexpected loss of boat control, resulting in serious injury or death due to occupants being thrown within or out of the boat. Always use required components and follow instructions and torque procedures.

Assemble steering link rod to steering cable with flat washer and nylon insert locknut. Tighten locknut until it seats, then back nut off 1/4 turn.



# INSTALLATION

Assemble steering link rod to engine with bolt, locknut, spacer, and flat washers. Torque locknut to specifications.

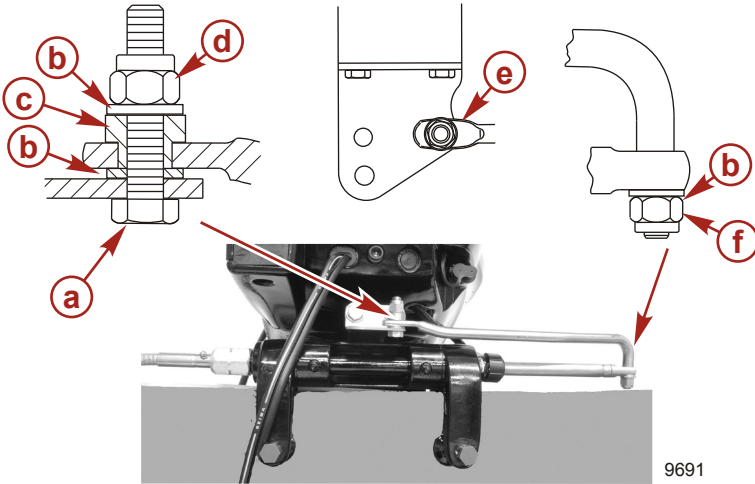

- a** - Bolt (10-898101018)
- b** - Flat washer (12-95392-10)
- c** - Spacer (23-853826001)
- d** - Nylon insert locknut (11-16147--3)
- e** - Install steering link rod into side hole
- f** - Nylon insert locknut (11-16147--3) (tighten until it seats, then back off 1/4 turn)

Description	Nm	lb. in.	lb. ft.
Nylon insert locknut "d"	27		20
Nylon insert locknut "f"	Tighten until it seats, then back off ¼ turn		

# INSTALLATION

## Electrical Harness, Battery Connection, Fuel Tanks

### REMOTE WIRING HARNESS

1. Remove the three access cover bolts. Remove the access cover and cable rubber grommet.

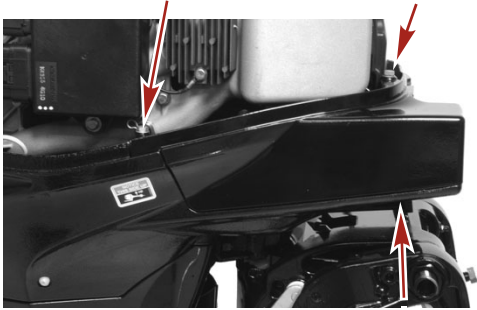

10113

2. Remove the cotter pin retainers and washers from the shift actuating lever, shift link, and throttle actuating lever.
3. Remove the shift link from the shift actuating lever.

# INSTALLATION

4. Loosen the bolt securing the control harness retainer bracket.

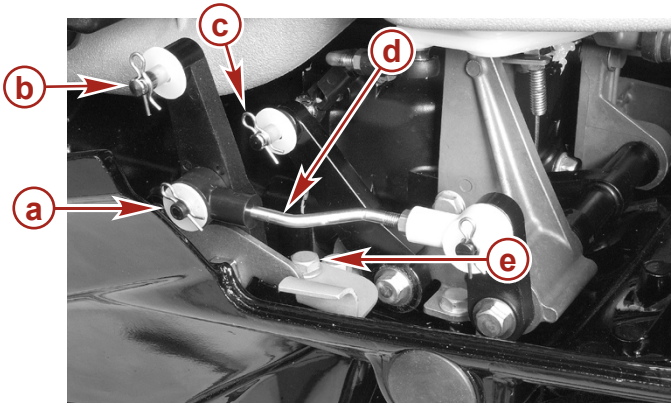

10114

- a** - Shift link, cotter pin retainer, and washer
  - b** - Shift actuating lever, cotter pin retainer, and washer
  - c** - Throttle actuating lever, cotter pin retainer, and washer
  - d** - Shift link
  - e** - Bolt securing harness retainer bracket
5. Remove the bolt securing the cable barrel retainer to the cowl.

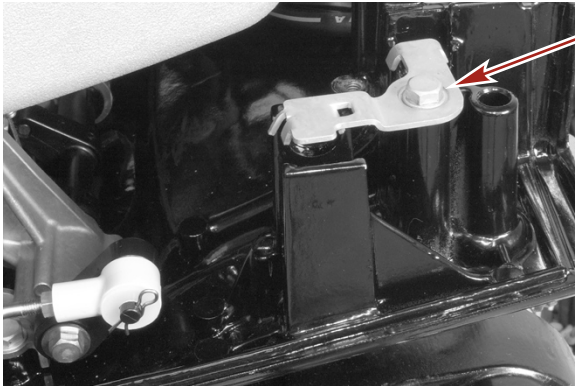

10127

6. Connect the remote harness to the engine harness connector.
7. Route the harness below the shift actuating lever pin.

# INSTALLATION

8. Route the harness between the barrel support.

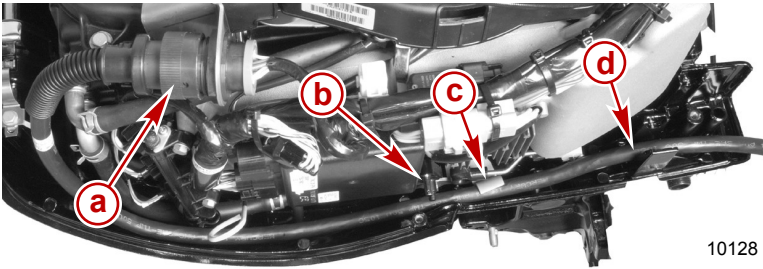

- a** - Harness connector
- b** - Shift actuating lever pin
- c** - Harness retainer bracket
- d** - Barrel support

9. Ensure the harness retainer bracket is over the remote harness. Secure harness retainer bracket with bolt. Tighten bolt to the specified torque.

10. Reinstall the shift link to the shift actuating lever.

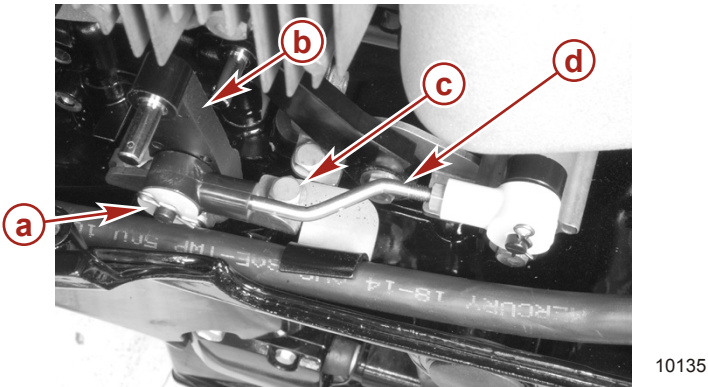

- a** - Washer and cotter pin retainer securing shift link
- b** - Shift actuating lever
- c** - Harness retainer bracket bolt
- d** - Shift link

# INSTALLATION

Description	Nm	lb. in.	lb. ft.
Bolt	6	53	

## BATTERY CABLE CONNECTIONS

**IMPORTANT:** To prevent damage to the engine charging system when the battery cables are not connected to a battery, ensure the battery cable ends are thoroughly insulated.

### Single Outboard

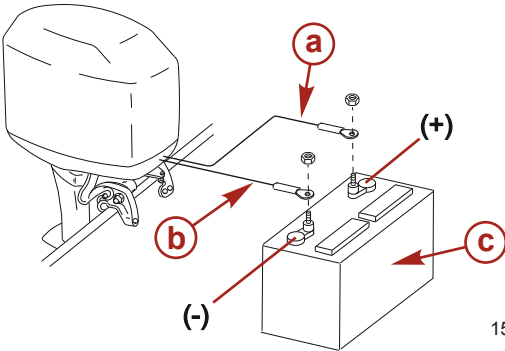

- a** - Red sleeve - positive (+)
- b** - Black sleeve - negative (-)
- c** - Cranking battery

15496

# INSTALLATION

## Dual Outboards

Connect a common ground cable (wire size same as engine battery cables) between negative (-) terminals on starting batteries.

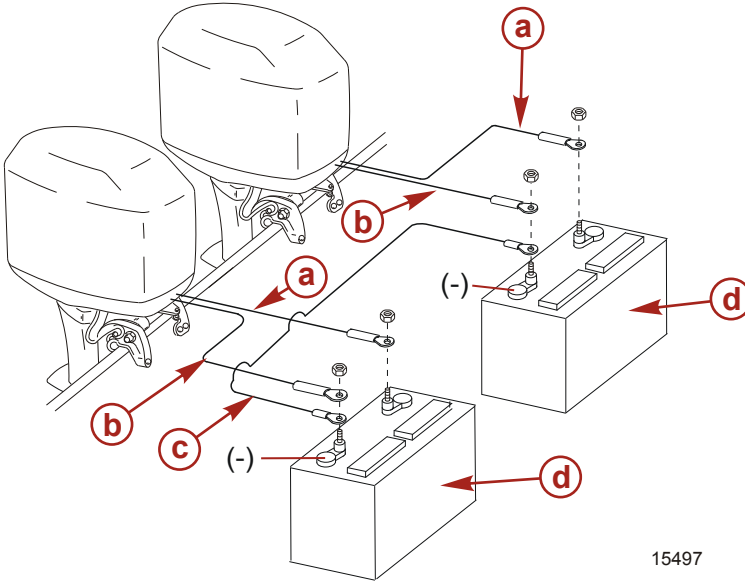

- a** - Red sleeve - positive (+)
- b** - Black sleeve - negative (-)
- c** - Ground cable
- d** - Cranking battery

## FUEL TANKS

### Portable Fuel Tank

Select a suitable location in the boat within the engine fuel line length limitations and secure the tank in place.

### Permanent Fuel Tank

Permanent fuel tanks should be installed in accordance with industry and federal safety standards, which include recommendations applicable to grounding, anti-siphon protection, ventilation, etc.

# INSTALLATION

## Control Cable Installation

### THROTTLE CABLE INSTALLATION

Install cables into the remote control following the instructions provided with the remote control.

1. Move the remote control handle from neutral into forward and advance the handle to full speed position.

**NOTE:** *The throttle cable is the second cable to move when moving the control box out of neutral.*

2. Install the throttle cable to the throttle actuating lever. Secure with a washer and cotter pin retainer.
3. Adjust the throttle cable barrel, so when barrel is installed into the throttle cable barrel support, no play can be felt when lightly pushing the throttle cam with your finger.

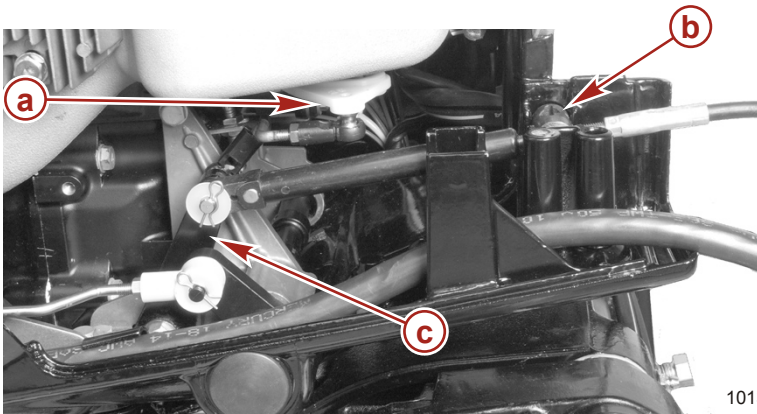

10136

- a** - Throttle cam (no play can be felt when lightly pushing)
  - b** - Throttle cable barrel support
  - c** - Throttle actuating lever
4. Slowly return the remote control handle back to the neutral detent position.
  5. Inspect cam roller to ensure it is not contacting the cam.

# INSTALLATION

6. Readjust the throttle cable barrel if the cam roller is touching the cam.

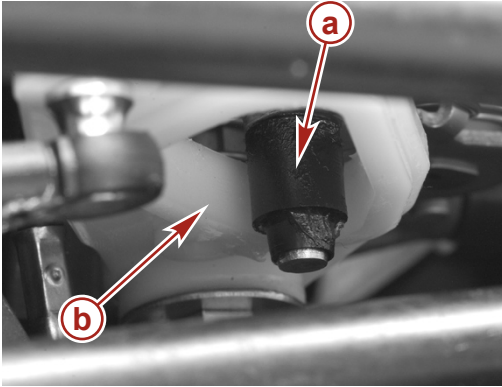

15952

- a** - Throttle cam
- b** - Cam roller

## SHIFT CABLE INSTALLATION

Install cables into the remote control following the instructions provided with the remote control.

1. Locate the center point of the slack or lost motion that exists in the shift cable as follows:
  - a. Move the remote control handle from neutral into forward and advance the handle to full speed position. Slowly return the handle back to the neutral. Place a mark ("a") on the cable end guide.
  - b. Move the remote control handle from neutral into reverse and advance the handle to full speed position. Slowly return the handle back to the neutral. Place a mark ("b") on the cable end guide.



# INSTALLATION

- c. Make a center mark ("c"), midway between marks ("a" and "b"). Align the cable end guide with this center mark when installing cable to the engine.

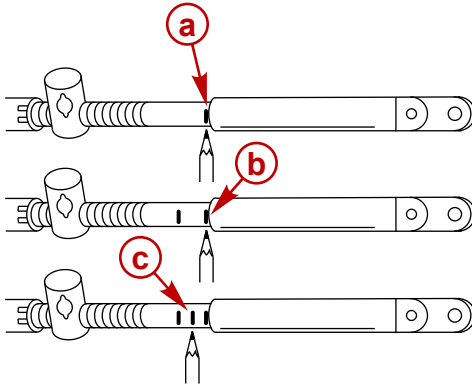

6098

2. Ensure the engine is in neutral.
3. Ensure the control box is in neutral.
4. Install the shift cable on shift actuating lever. Secure with washer and cotter pin retainer. Adjust cable barrel so the center mark on the cable guide is in alignment when the shift cable barrel is in the barrel support in the cowl.

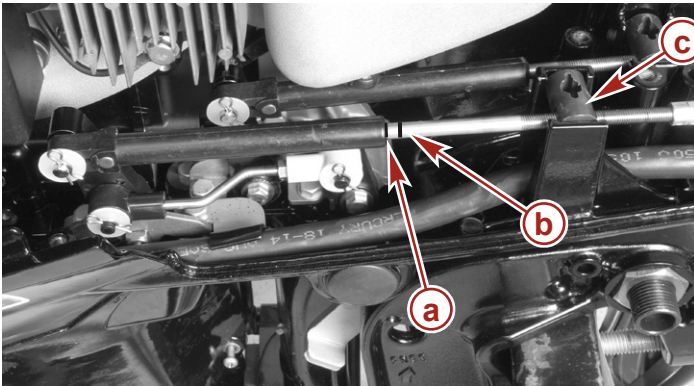

15896

- a** - Center mark on cable guide
- b** - First mark on cable guide

5. Check shift cable adjustments as follows:

# INSTALLATION

- a. Shift remote control into forward. The propeller shaft should be locked in gear. If not, adjust the barrel closer to the cable end.
  - b. Shift remote control into reverse while turning propeller. The propeller shaft should be locked in gear. If not, adjust the barrel away from the cable end. Repeat steps a through c.
  - c. Shift remote control back to neutral. The propeller shaft should turn freely without drag. If not, adjust the barrel closer to the cable end. Repeat steps a through c.
6. Install the cable grommet.
  7. Secure the throttle and shift cable barrels with the cable barrel retainer.
  8. Tighten the cable barrel retainer bolt to the specified torque.

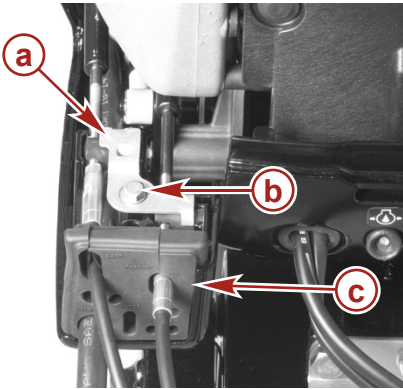

- a** - Cable barrel retainer
- b** - Cable barrel retainer bolt
- c** - Cable grommet

15855

Description	Nm	lb. in.	lb. ft.
Cable barrel retainer bolt	6	53	

# INSTALLATION

- Install the access cover and secure with three bolts. Tighten bolts to the specified torque.

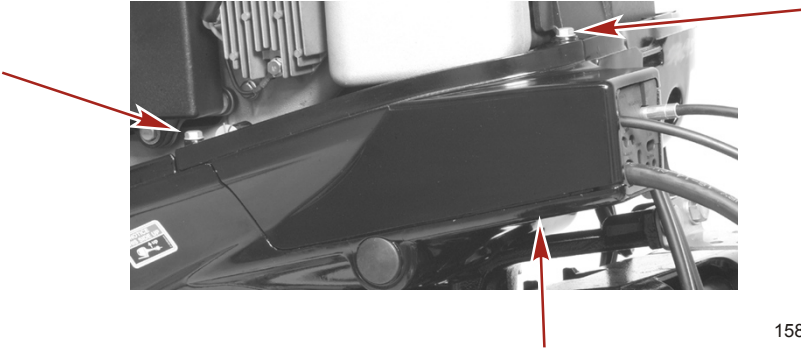

15858

Description	Nm	lb. in.	lb. ft.
Access cover bolt (3)	10	88	

## Installing Propeller

### **⚠ WARNING**

Rotating propellers can cause serious injury or death. Never operate the boat out of the water with a propeller installed. Before installing or removing a propeller, place the drive unit in neutral and engage the lanyard stop switch to prevent the engine from starting. Place a block of wood between the propeller blade and the anti-ventilation plate.

- Shift outboard to neutral (N) position.

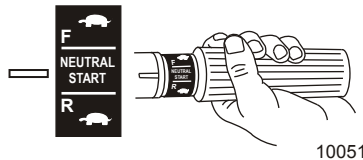
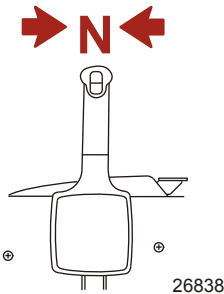

# INSTALLATION

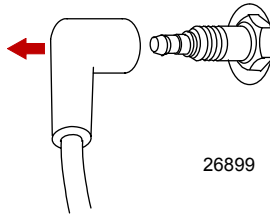

2. Remove spark plug leads to prevent engine from starting.

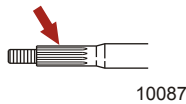

3. Coat the propeller shaft with Anti-Corrosion Grease or 2-4-C with PTFE.

**IMPORTANT:** To prevent the propeller hub from corroding and seizing to the propeller shaft (especially in salt water), always apply a coat of the recommended lubricant to the entire propeller shaft at the recommended maintenance intervals and also each time the propeller is removed.



Tube Ref No.	Description	Where Used	Part No.
 94	Anti-Corrosion Grease	Propeller shaft	92-802867Q 1
 95	2-4-C with PTFE	Propeller shaft	92-802859A 1

4. Install front thrust hub, propeller, rear thrust washer and propeller nut onto the shaft.

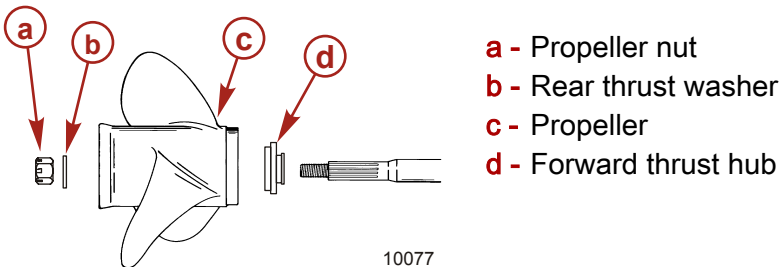

5. Place a block of wood between gearcase and propeller and torque propeller nut to specification.

# INSTALLATION

**NOTE:** If the propeller nut does not align with the propeller shaft hole after tightening to the specified torque, then tighten the nut further to align it with the hole in the propeller shaft.

- Align the propeller nut with the propeller shaft hole. Insert a new cotter pin in the hole and bend the cotter pin ends.

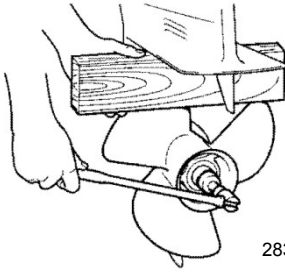

28353

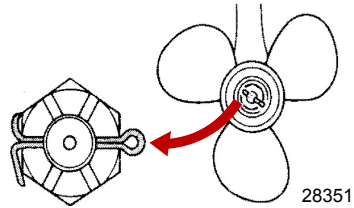

28351

Description	Nm	lb. in.	lb. ft.
Propeller nut	25		18