

**Declaration of Conformity Four Stroke - For Recreational Craft Propulsion Engines with the Requirements of Directive 94/25/EC as amended by 2003/44/EC**

**Name of engine manufacturer:** Mercury Marine  
**Address:** W6250 Pioneer Road P.O. Box 1939  
**Town:** Fond du Lac, WI      **Post Code:** 54936-1939      **Country:** USA

**Name of Authorized Representative:** Brunswick Marine in EMEA Inc.  
**Address:** Parc Industriel de Petit-Rechain  
**Town:** Verviers      **Post Code:** 4800      **Country:** Belgium

**Name of Notified Body for exhaust emission assessment:** Det Norske Veritas AS  
**Address:** Veritasveien 1  
**Town:** Hovik      **Post Code:** 1322      **Country:** Norway      **ID Number:** 0575

**Name of Notified Body for noise emission assessment:** Det Norske Veritas AS  
**Address:** Veritasveien 1  
**Town:** Hovik      **Post Code:** 1322      **Country:** Norway      **ID Number:** 0575

**Conformity assessment module used for exhaust emissions:**       B       B       B       B       G       H  
    +C      +D      +E      +F

**or engine type approved according to:**       stage II of Directive 97/68/EC       Directive 88/77/EC

**Conformity assessment module used for noise emissions:**       A       Aa       G       H

**Other Community Directives applied: Safety of Machinery Directive 98/37/EC; Electromagnetic Compatibility Directive 2004/108/EC**

90-10249082 1008

**135/150/175/200 Verado FourStroke**

© 2009 Mercury Marine

## Description of Engines and Essential Requirements

<b>Engine Type</b>	<b>Fuel Type</b>	<b>Combustion Cycle</b>
<input type="checkbox"/> z or sterndrive without integral exhaust	<input type="checkbox"/> Diesel	<input type="checkbox"/> 2 stroke
<input checked="" type="checkbox"/> Outboard engine	<input checked="" type="checkbox"/> Petrol	<input checked="" type="checkbox"/> 4 stroke

## Identification of Engines Covered by This Declaration of Conformity

Name of engine family	Unique engine identification number: starting serial number	EC Module H certificate number
Verado 6 cylinder 200, 225, 250, 275, 300 hp	OP401000 or 1B227000	RCD-H-2
Verado 4 cylinder 135, 150, 175, 200 hp	OP401000 or 1B227000	RCD-H-2
L4NA 4 cylinder 80, 100, 115 hp	OP401000 or 1B227000	RCD-H-2

Essential requirements	standards	other normative document/ method	technical file	Please specify in more detail (* = mandatory standard)
<b>Annex 1.B—Exhaust Emissions</b>				
B.1 engine identification	<input type="checkbox"/>	<input type="checkbox"/>	<input checked="" type="checkbox"/>	
B.2 exhaust emission requirements	<input checked="" type="checkbox"/> *	<input type="checkbox"/>	<input type="checkbox"/>	* EN ISO 8718-1:1996
B.3 durability	<input type="checkbox"/>	<input type="checkbox"/>	<input checked="" type="checkbox"/>	
B.4 owner's manual	<input checked="" type="checkbox"/>	<input type="checkbox"/>	<input type="checkbox"/>	ISO 8665: 1995
<b>Annex 1.C—Noise Emissions</b>				
C.1 Noise emission levels	<input checked="" type="checkbox"/> *	<input type="checkbox"/>	<input type="checkbox"/>	EN ISO 14509
C.2 Owner's manual	<input type="checkbox"/>	<input checked="" type="checkbox"/>	<input type="checkbox"/>	Owner's manual

This declaration of conformity is issued under the sole responsibility of the manufacturer. I declare on behalf of the engine manufacturer that the engines mentioned preceding complies with all applicable essential requirements in the way specified.

**Name /  
function:**  
Mark D.  
Schwabero,  
President,  
Mercury  
Outboard

**Signature and title:**



**Date and place of issue:** July 24, 2008  
Fond du Lac, Wisconsin



# TABLE OF CONTENTS

---

## WARRANTY INFORMATION

---

Transfer of Warranty.....	1
Warranty Registration United States and Canada.....	1
Warranty Registration Outside the United States and Canada... ..	2
FourStroke Outboard Limited Warranty United States, Canada, Europe, Confederation of Independent States, Middle-East and Africa.....	3
3 Year Limited Warranty Against Corrosion.....	6
Warranty Coverage and Exclusions.....	10

---

## General Information

---

Boater's Responsibilities.....	13
Before Operating Your Outboard.....	13
Boat Horsepower Capacity.....	14
High-Speed and High-Performance Boat Operation.....	14
Outboard Remote Control Models .....	14
Lanyard Stop Switch.....	15
Protecting People in the Water.....	17
Passenger Safety Message - Pontoon Boats and Deck Boats..	18
Wave and Wake Jumping.....	19
Impact with Underwater Hazards.....	20
Exhaust Emissions.....	21
Selecting Accessories for Your Outboard.....	23
Safe Boating Suggestions.....	24
Recording Serial Number.....	26
135/150/175/200 Specifications - International.....	26
Component Identification.....	28

---

## Installation

---

Installing Outboard.....	29
Propeller Selection.....	30

# TABLE OF CONTENTS

---

## Transporting

---

Trailering Boat/Outboard.....	31
-------------------------------	----

---

## Fuel and Oil

---

Fuel Recommendations.....	32
Low Permeation Fuel Hose Requirement .....	33
Filling Fuel Tank.....	34
Engine Oil Recommendations.....	34
Checking and Adding Engine Oil.....	35

---

## Features and Controls

---

Panel Mount Control Features and Operation.....	38
Single Handle Console Control Features and Operation.....	41
Slim Binnacle Control Features and Operation.....	46
Dual Handle Console Control Features and Operation.....	50
Dual Handle Console Control with CAN Trackpad Features and Operation.....	55
Shadow Mode Control Features and Operation.....	60
Shadow Mode Control with CAN Trackpad Features and Operation.....	67
Warning System.....	76
Power Trim and Tilt.....	78

---

## Operation

---

Pre-Starting Check List.....	83
Operating in Freezing Temperatures.....	83
Operating in Saltwater or Polluted Water.....	83
Setting Trim Angle While Running Engine at Idle Speed.....	84
Engine Break-in Procedure.....	84
Starting the Engine.....	85
Gear Shifting.....	87
Stopping the Engine.....	89

# TABLE OF CONTENTS

---

## Maintenance

---

Outboard Care.....	90
EPA Emissions.....	90
Inspection and Maintenance Schedule.....	91
Flushing the Cooling System.....	93
Top Cowl Removal and Installation.....	94
Cleaning Care for Top and Bottom Cowls.....	95
Cleaning Care for the Powerhead (Saltwater Use).....	96
Battery Inspection .....	96
Verado Engine Battery Specifications.....	96
Air Filter.....	98
Fuel System.....	102
Corrosion Control Anode.....	106
Propeller Replacement.....	106
Spark Plug Inspection and Replacement.....	108
Fuses.....	112
Steering Link Rod Fasteners.....	114
DTS Wiring System.....	115
Accessory Drive Belt Inspection.....	115
Lubrication Points.....	115
Checking Power Trim Fluid.....	119
Checking Power Steering Fluid.....	120
Changing Engine Oil.....	120
Gearcase Lubrication.....	123

---

## Storage

---

Storage Preparation.....	126
Protecting External Outboard Components.....	127
Protecting Internal Engine Components.....	127
Gearcase.....	127
Positioning Outboard for Storage.....	128
Battery Storage.....	128

# TABLE OF CONTENTS

---

## Troubleshooting

---

Starter Motor Will Not Crank the Engine.....	129
Engine Will Not Start.....	129
Engine Starts But Will Not Shift Into Gear.....	129
Engine Runs Erratically.....	130
Performance Loss.....	130
Battery Will Not Hold Charge.....	130

---

## Owner Service Assistance

---

Local Repair Service.....	132
Service Away from Home.....	132
Parts and Accessories Inquiries.....	132
Service Assistance.....	132
Mercury Marine Service Offices.....	133



# WARRANTY INFORMATION

## Transfer of Warranty

The limited warranty is transferable to a subsequent purchaser, but only for the remainder of the unused portion of the limited warranty. This will not apply to products used for commercial applications.

To transfer the warranty to the subsequent owner, send or fax a copy of the bill of sale or purchase agreement, new owner's name, address and engine serial number to Mercury Marine's warranty registration department. In the United States and Canada, mail to:

Mercury Marine

Attn: Warranty Registration Department

W6250 W. Pioneer Road

P.O. Box 1939

Fond du Lac, WI 54936-1939

920-929-5054

Fax +1 920 929 5893

Upon processing the transfer of warranty, Mercury Marine will send registration verification to the new owner of the product by mail.

There is no charge for this service.

For products purchased outside the United States and Canada, contact the distributor in your country, or the Marine Power Service Center closest to you.

## Warranty Registration United States and Canada

*Outside United States and Canada - Check with your local distributor.*

1. You may change your address at any time, including at time of warranty claim, by calling Mercury Marine or sending a letter or fax with your name, old address, new address, and engine serial number to Mercury Marine's warranty registration department. Your dealer can also process this change of information.

# WARRANTY INFORMATION

Mercury Marine  
Attn: Warranty Registration Department  
W6250 W. Pioneer Road  
P.O. Box 1939  
Fond du Lac, WI 54936-1939  
920-929-5054  
Fax +1 920 929 5893

***NOTE: Registration lists must be maintained by Mercury Marine and any dealer on marine products sold in the United States, should a safety recall notification under the Federal Safety Act be required.***

2. To be eligible for warranty coverage, the product must be registered with Mercury Marine. At the time of sale, the dealer should complete the warranty registration and immediately submit it to Mercury Marine via MercNET, E-mail, or mail. Upon receipt of this warranty registration, Mercury Marine will record the registration.
3. Upon processing the warranty registration, Mercury Marine will send registration verification by mail to the purchaser of the product. If this registration verification is not received within 30 days, please contact your selling dealer immediately. Warranty coverage is not effective until your product is registered with Mercury Marine.

## Warranty Registration Outside the United States and Canada

1. It is important that your selling dealer fills out the Warranty Registration Card completely and mails it to the distributor or Marine Power Service Center responsible for administering the warranty registration/claim program for your area.
2. The Warranty Registration Card identifies your name and address, product model and serial numbers, date of sale, type of use and the selling distributor's/dealer's code number, name and address. The distributor/dealer also certifies that you are the original purchaser and user of the product.

## WARRANTY INFORMATION

3. A copy of the Warranty Registration Card, designated as the Purchaser's Copy, MUST be given to you immediately after the card has been completely filled out by the selling distributor/dealer. This card represents your factory registration identification and should be retained by you for future use when required. Should you ever require warranty service on this product, your dealer may ask you for the Warranty Registration Card to verify date of purchase and to use the information on the card to prepare the warranty claim forms.
4. In some countries, the Marine Power Service Center will issue you a permanent (plastic) Warranty Registration Card within 30 days after receiving the Factory Copy of the Warranty Registration Card from your distributor/dealer. If you receive a plastic Warranty Registration Card, you may discard the Purchaser's Copy that you received from the distributor/dealer when you purchased the product. Ask your distributor/dealer if this plastic card program applies to you.

**IMPORTANT: Registration lists must be maintained by the factory and dealer in some countries by law. It is our desire to have ALL products registered at the factory should it ever be necessary to contact you. Make sure your dealer/distributor fills out the warranty registration card immediately and sends the factory copy to the Marine Power International Service Center for your area.**

5. For further information concerning the Warranty Registration Card and its relationship to Warranty Claim processing, refer to the International Warranty.

### **FourStroke Outboard Limited Warranty United States, Canada, Europe, Confederation of Independent States, Middle-East and Africa**

Outside the United States, Canada, Europe, Confederation of Independent States, Middle-East and Africa - check with your local distributor.

**WHAT IS COVERED:** Mercury Marine warrants its new Outboard and Jet Products to be free of defects in material and workmanship during the period described below.

# WARRANTY INFORMATION

**DURATION OF COVERAGE:** This Limited Warranty provides coverage for three (3) years from the date the product is first sold to a recreational use retail purchaser, or the date on which the product is first put into service, whichever occurs first. Commercial users of these products receive warranty coverage of one (1) year from the date of first retail sale, or one (1) year from the date in which the product was first put into service, whichever occurs first. Commercial use is defined as any work or employment related use of the product, or any use of the product which generates income, for any part of the warranty period, even if the product is only occasionally used for such purposes. The repair or replacement of parts, or the performance of service under this warranty, does not extend the life of this warranty beyond its original expiration date. Unexpired warranty coverage can be transferred from one recreational use customer to a subsequent recreational use customer upon proper re-registration of the product. Unexpired warrant coverage cannot be transferred either to or from a commercial use customer.

**CONDITIONS THAT MUST BE MET IN ORDER TO OBTAIN WARRANTY COVERAGE:** Warranty coverage is available only to retail customers that purchase from a Dealer authorized by Mercury Marine to distribute the product in the country in which the sale occurred, and then only after the Mercury Marine specified pre-delivery inspection process is completed and documented. Warranty coverage becomes available upon proper registration of the product by the authorized dealer. Routine maintenance outlined in the Operation and Maintenance Manual must be timely performed in order to maintain warranty coverage. Mercury Marine reserves the right to make future warranty coverage contingent on proof of proper maintenance.

**WHAT MERCURY WILL DO:** Mercury's sole and exclusive obligation under this warranty is limited to, at our option, repairing a defective part, replacing such part or parts with new or Mercury Marine certified remanufactured parts, or refunding the purchase price of the Mercury product. Mercury reserves the right to improve or modify products from time to time without assuming an obligation to modify products previously manufactured.

# WARRANTY INFORMATION

**HOW TO OBTAIN WARRANTY COVERAGE:** The customer must provide Mercury with a reasonable opportunity to repair, and reasonable access to the product for warranty service. Warranty claims shall be made by delivering the product for inspection to a Mercury dealer authorized to service the product. If purchaser cannot deliver the product to such a dealer, written notice must be given to Mercury. We will then arrange for the inspection and any covered repair. Purchaser in that case shall pay for all related transportation charges and/or travel time. If the service provided is not covered by this warranty, purchaser shall pay for all related labor and material, and any other expenses associated with that service. Purchaser shall not, unless requested by Mercury, ship the product or parts of the product directly to Mercury. Proof of registered ownership must be presented to the dealer at the time warranty service is requested in order to obtain coverage.

**WHAT IS NOT COVERED:** This limited warranty does not cover routine maintenance items, tune ups, adjustments, normal wear and tear, damage caused by abuse, abnormal use, use of a propeller or gear ratio that does not allow the engine to run in its recommended wide open throttle RPM range (see the Operation and Maintenance Manual), operation of the product in a manner inconsistent with the recommended operation/duty cycle section of the Operation and Maintenance Manual, neglect, accident, submersion, improper installation (proper installation specifications and techniques are set forth in the installation instructions for the product), improper service, use of an accessory or part not manufactured or sold by us, jet pump impellers and liners, operation with fuels, oils or lubricants which are not suitable for use with the product (see the Operation and Maintenance Manual), alteration or removal of parts, or water entering the engine through the fuel intake, air intake or exhaust system, or damage to the product from insufficient cooling water caused by blockage of the cooling system by a foreign body, running the engine out of water, mounting the engine too high on the transom, or running the boat with the engine trimmed out too far.. Use of the product for racing or other competitive activity, or operating with a racing type lower unit, at any point, even by a prior owner of the product, voids the warranty.

## WARRANTY INFORMATION

Expenses related to haul out, launch, towing, storage, telephone, rental, inconvenience, slip fees, insurance coverage, loan payments, loss of time, loss of income, or any other type of incidental or consequential damages are not covered by this warranty. Also, expenses associated with the removal and/or replacement of boat partitions or material caused by boat design for access to the product are not covered by this warranty.

No individual or entity, including Mercury Marine authorized dealers, has been given authority by Mercury Marine to make any affirmation, representation or warranty regarding the product, other than those contained in this limited warranty, and if made, shall not be enforceable against Mercury Marine.

For additional information regarding events and circumstances covered by this warranty, and those that are not, see the Warranty Coverage section of the Operation and Maintenance Manual, incorporated by reference into this warranty.

<b>DISCLAIMERS AND LIMITATIONS:</b>
<b>THE IMPLIED WARRANTIES OF MERCHANTABILITY AND FITNESS FOR A PARTICULAR PURPOSE ARE EXPRESSLY DISCLAIMED. TO THE EXTENT THAT THEY CANNOT BE DISCLAIMED, THE IMPLIED WARRANTIES ARE LIMITED IN DURATION TO THE LIFE OF THE EXPRESS WARRANTY. INCIDENTAL AND CONSEQUENTIAL DAMAGES ARE EXCLUDED FROM COVERAGE UNDER THIS WARRANTY. SOME STATES/COUNTRIES DO NOT ALLOW FOR THE DISCLAIMERS, LIMITATIONS AND EXCLUSIONS IDENTIFIED ABOVE, AS A RESULT, THEY MAY NOT APPLY TO YOU. THIS WARRANTY GIVES YOU SPECIFIC LEGAL RIGHTS, AND YOU MAY ALSO HAVE OTHER LEGAL RIGHTS WHICH VARY FROM STATE TO STATE AND COUNTRY TO COUNTRY.</b>

### 3 Year Limited Warranty Against Corrosion

**WHAT IS COVERED:** Mercury Marine warrants that each new Mercury, Mariner, Mercury Racing, Sport Jet, M<sup>2</sup> Jet Drive, Tracker by Mercury Marine Outboard, Mercury MerCruiser Inboard or Sterndrive Engine (Product) will not be rendered inoperative as a direct result of corrosion for the period of time described below.

## WARRANTY INFORMATION

**DURATION OF COVERAGE:** This limited corrosion warranty provides coverage for three (3) years from either the date the product is first sold, or the date on which the product is first put into service, whichever occurs first. The repair or replacement of parts, or the performance of service under this warranty does not extend the life of this warranty beyond its original expiration date.

Unexpired warranty coverage can be transferred to subsequent (noncommercial use) purchaser upon proper reregistration of the product.

**CONDITIONS THAT MUST BE MET IN ORDER TO OBTAIN WARRANTY COVERAGE:** Warranty coverage is available only to retail customers that purchase from a Dealer authorized by Mercury Marine to distribute the product in the country in which the sale occurred, and then only after the Mercury Marine specified predelivery inspection process is completed and documented.

Warranty coverage becomes available upon proper registration of the product by the authorized dealer. Corrosion prevention devices specified in the Operation and Maintenance Manual must be in use on the boat, and routine maintenance outlined in the Operation and Maintenance Manual must be timely performed (including without limitation the replacement of sacrificial anodes, use of specified lubricants, and touch-up of nicks and scratches) in order to maintain warranty coverage. Mercury Marine reserves the right to make warranty coverage contingent upon proof of proper maintenance.

**WHAT MERCURY WILL DO:** Mercury's sole and exclusive obligation under this warranty is limited to, at our option, repairing a corroded part, replacing such part or parts with new or Mercury Marine certified remanufactured parts, or refunding the purchase price of the Mercury product. Mercury reserves the right to improve or modify products from time to time without assuming an obligation to modify products previously manufactured.

## WARRANTY INFORMATION

**HOW TO OBTAIN WARRANTY COVERAGE:** The customer must provide Mercury with a reasonable opportunity to repair, and reasonable access to the product for warranty service. Warranty claims shall be made by delivering the product for inspection to a Mercury dealer authorized to service the product. If purchaser cannot deliver the product to such a dealer, written notice must be given to Mercury. We will then arrange for the inspection and any covered repair. Purchaser in that case shall pay for all related transportation charges and/or travel time. If the service provided is not covered by this warranty, purchaser shall pay for all related labor and material, and any other expenses associated with that service. Purchaser shall not, unless requested by Mercury, ship the product or parts of the product directly to Mercury. Proof of registered ownership must be presented to the dealer at the time warranty service is requested in order to obtain coverage.

**WHAT IS NOT COVERED:** This limited warranty does not cover electrical system corrosion; corrosion resulting from damage, corrosion which causes purely cosmetic damage, abuse or improper service; corrosion to accessories, instruments, steering systems; corrosion to factory installed jet drive unit; damage due to marine growth; product sold with less than a one year limited Product warranty; replacement parts (parts purchased by customer); products used in a commercial application. Commercial use is defined as any work or employment related use of the product, or any use of the product which generates income, for any part of the warranty period, even if the product is only occasionally used for such purposes.



## WARRANTY INFORMATION

Corrosion damage caused by stray electrical currents (on-shore power connections, nearby boats, submerged metal) is not covered by this corrosion warranty and should be protected against by the use of a corrosion protection system, such as the Mercury Precision Parts or Quicksilver MerCathode system and/or Galvanic Isolator. Corrosion damage caused by improper application of copper base anti-fouling paints is also not covered by this limited warranty. If anti-fouling protection is required, Tri-Butyl-Tin-Adipate (TBTA) base anti-fouling paints are recommended on Outboard and MerCruiser boating applications. In areas where TBTA base paints are prohibited by law, copper base paints can be used on the hull and transom. Do not apply paint to the outboard or MerCruiser product. In addition, care must be taken to avoid an electrical interconnection between the warranted product and the paint. For MerCruiser product, an unpainted gap of at least 38 mm (1.5 in.) should be left around the transom assembly. Refer to the Operation and Maintenance Manual for additional details.

For additional information regarding events and circumstances covered by this warranty, and those that are not, see the Warranty Coverage section of the Operation and Maintenance Manual, incorporated by reference into this warranty.

### **DISCLAIMERS AND LIMITATIONS:**

**THE IMPLIED WARRANTIES OF MERCHANTABILITY AND FITNESS FOR A PARTICULAR PURPOSE ARE EXPRESSLY DISCLAIMED. TO THE EXTENT THAT THEY CANNOT BE DISCLAIMED, THE IMPLIED WARRANTIES ARE LIMITED IN DURATION TO THE LIFE OF THE EXPRESS WARRANTY. INCIDENTAL AND CONSEQUENTIAL DAMAGES ARE EXCLUDED FROM COVERAGE UNDER THIS WARRANTY. SOME STATES/COUNTRIES DO NOT ALLOW FOR THE DISCLAIMERS, LIMITATIONS AND EXCLUSIONS IDENTIFIED ABOVE, AS A RESULT, THEY MAY NOT APPLY TO YOU. THIS WARRANTY GIVES YOU SPECIFIC LEGAL RIGHTS, AND YOU MAY ALSO HAVE OTHER LEGAL RIGHTS WHICH VARY FROM STATE TO STATE AND COUNTRY TO COUNTRY.**

# WARRANTY INFORMATION

## Warranty Coverage and Exclusions

The purpose of this section is to help eliminate some of the more common misunderstandings regarding warranty coverage. The following information explains some of the types of services that are not covered by warranty. The provisions set forth following have been incorporated by reference into the Three Year Limited Warranty Against Corrosion Failure, the International Limited Outboard Warranty, and the United States and Canada Limited Outboard Warranty.

Keep in mind that warranty covers repairs that are needed within the warranty period because of defects in material and workmanship. Installation errors, accidents, normal wear, and a variety of other causes that affect the product are not covered.

Warranty is limited to defects in material or workmanship, but only when the consumer sale is made in the country to which distribution is authorized by us.

Should you have any questions concerning warranty coverage, contact your authorized dealer. They will be pleased to answer any questions that you may have.

## GENERAL EXCLUSIONS FROM WARRANTY

1. Minor adjustments and tune-ups, including checking, cleaning, or adjusting spark plugs, ignition components, carburetor settings, filters, belts, controls, and checking lubrication made in connection with normal services.
2. Factory installed jet drive units - Specific parts excluded from the warranty are: the jet drive impeller and jet drive liner damaged by impact or wear, and water damaged driveshaft bearings as a result of improper maintenance.
3. Damage caused by neglect, lack of maintenance, accident, abnormal operation, or improper installation or service.
4. Haul-out, launch, towing charges, removal and/or replacement of boat partitions or material because of boat design for necessary access to the product, all related transportation charges and/or travel time, etc. Reasonable access must be provided to the product for warranty service. Customer must deliver product to an authorized dealer.

## WARRANTY INFORMATION

5. Additional service work requested by customer other than that necessary to satisfy the warranty obligation.
6. Labor performed by other than an authorized dealer may be covered only under the following circumstances: when performed on emergency basis (providing there are no authorized dealers in the area who can perform the work required or have no facilities to haul-out, etc., and prior factory approval has been given to have the work performed at this facility).
7. All incidental and/or consequential damages (storage charges, telephone or rental charges of any type, inconvenience or loss of time or income) are the owner's responsibility.
8. Use of other than Mercury Precision or Quicksilver parts when making warranty repairs.
9. Oils, lubricants, or fluids changed as a matter of normal maintenance is customer's responsibility unless loss or contamination of same is caused by product failure that would be eligible for warranty consideration.
10. Participating in or preparing for racing or other competitive activity or operating with a racing type lower unit.
11. Engine noise does not necessarily indicate a serious engine problem. If diagnosis indicates a serious internal engine condition which could result in a failure, condition responsible for noise should be corrected under the warranty.
12. Lower unit and/or propeller damage caused by striking a submerged object is considered a marine hazard.
13. Water entering engine through the fuel intake, air intake, or exhaust system or submersion.
14. Failure of any parts caused by lack of cooling water, which results from starting motor out of water, foreign material blocking inlet holes, motor being mounted too high, or trimmed too far out.
15. Use of fuels and lubricants which are not suitable for use with or on the product. Refer to the **Maintenance** section.

## WARRANTY INFORMATION

16. Our limited warranty does not apply to any damage to our products caused by the installation or use of parts and accessories which are not manufactured or sold by us. Failures which are not related to the use of those parts or accessories are covered under warranty if they otherwise meet the terms of the limited warranty for that product.

# GENERAL INFORMATION

## Boater's Responsibilities

The operator (driver) is responsible for the correct and safe operation of the boat and safety of its occupants and general public. It is strongly recommended that each operator (driver) read and understand this entire manual before operating the outboard.

Be sure at least one additional person onboard is instructed in the basics of starting and operating the outboard and boat handling in case the driver is unable to operate the boat.

## Before Operating Your Outboard

Read this manual carefully. Learn how to operate your outboard properly. If you have any questions, contact your dealer.

Safety and operating information that is practiced, along with using good common sense, can help prevent personal injury and product damage.

This manual as well as safety labels posted on the outboard use the following safety alerts to draw your attention to special safety instructions that should be followed.

### **DANGER**

Indicates a hazardous situation which, if not avoided, will result in death or serious injury.

### **WARNING**

Indicates a hazardous situation which, if not avoided, could result in death or serious injury.

### **CAUTION**

Indicates a hazardous situation which, if not avoided, could result in minor or moderate injury.

### *NOTICE*

Indicates a situation which, if not avoided, could result in engine or major component failure.

# GENERAL INFORMATION

## Boat Horsepower Capacity

### WARNING

Exceeding the boat's maximum horsepower rating can cause serious injury or death. Overpowering the boat can affect boat control and flotation characteristics or break the transom. Do not install an engine that exceeds the boat's maximum power rating.

Do not overpower or overload your boat. Most boats will carry a required capacity plate indicating the maximum acceptable power and load as determined by the manufacturer following certain federal guidelines. If in doubt, contact your dealer or the boat manufacturer.

U.S. COAST GUARD CAPACITY	
MAXIMUM HORSEPOWER	XXX
MAXIMUM PERSON CAPACITY (POUNDS)	XXX
MAXIMUM WEIGHT CAPACITY	XXX

26777

## High-Speed and High-Performance Boat Operation

If your outboard is to be used on a high-speed or high-performance boat with which you are unfamiliar, we recommend that you never operate it at its high speed capability without first requesting an initial orientation and familiarization demonstration ride with your dealer or an operator experienced with your boat/outboard combination. For additional information, obtain a copy of our **Hi-Performance Boat Operation** booklet from your dealer, distributor, or Mercury Marine.

## Outboard Remote Control Models

The outboard must be equipped with a Mercury remote control designed for digital throttle and shift. Start-in-gear protection is provided by the remote control system.

# GENERAL INFORMATION

## Lanyard Stop Switch

The purpose of a lanyard stop switch is to turn off the engine when the operator moves far enough away from the operator's position (as in accidental ejection from the operator's position) to activate the switch. Tiller handle outboards and some remote control units are equipped with a lanyard stop switch. A lanyard stop switch can be installed as an accessory - generally on the dashboard or side adjacent to the operator's position.

The lanyard is a cord usually 122–152 cm (4–5 feet) in length when stretched out, with an element on one end made to be inserted into the switch and a snap on the other end for attaching to the operator. The lanyard is coiled to make its at-rest condition as short as possible to minimize the likelihood of lanyard entanglement with nearby objects. Its stretched-out length is made to minimize the likelihood of accidental activation should the operator choose to move around in an area close to the normal operator's position. If it is desired to have a shorter lanyard, wrap the lanyard around the operator's wrist or leg, or tie a knot in the lanyard.

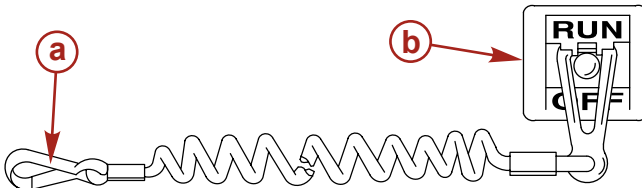

21629

- a** - Lanyard cord
- b** - Lanyard stop switch

Read the following Safety Information before proceeding.

## GENERAL INFORMATION

**Important Safety Information:** The purpose of a lanyard stop switch is to stop the engine when the operator moves far enough away from the operator's position to activate the switch. This would occur if the operator accidentally falls overboard or moves within the boat a sufficient distance from the operator's position. Falling overboard and accidental ejections are more likely to occur in certain types of boats such as low sided inflatables, bass boats, high performance boats, and light, sensitive handling fishing boats operated by a hand tiller. Falling overboard and accidental ejections are also likely to occur as a result of poor operating practices such as sitting on the back of the seat or gunwale at planing speeds, standing at planing speeds, sitting on elevated fishing boat decks, operating at planing speeds in shallow or obstacle infested waters, releasing your grip on a steering wheel or tiller handle that is pulling in one direction, drinking alcohol or consuming drugs, or daring high speed boat maneuvers.

While activation of the lanyard stop switch will stop the engine immediately, a boat will continue to coast for some distance depending upon the velocity and degree of any turn at shut down. However, the boat will not complete a full circle. While the boat is coasting, it can cause injury to anyone in the boat's path as seriously as the boat would when under power.

We strongly recommend that other occupants be instructed on proper starting and operating procedures should they be required to operate the engine in an emergency (e.g. if the operator is accidentally ejected).

### WARNING

If the operator falls out of the boat, stop the engine immediately to reduce the possibility of serious injury or death from being struck by the boat. Always properly connect the operator to the stop switch using a lanyard.

### WARNING

Avoid serious injury or death from deceleration forces resulting from accidental or unintended stop switch activation. The boat operator should never leave the operator's station without first disconnecting the stop switch lanyard from the operator.



# GENERAL INFORMATION

Accidental or unintended activation of the switch during normal operation is also a possibility. This could cause any, or all, of the following potentially hazardous situations:

- Occupants could be thrown forward due to unexpected loss of forward motion - a particular concern for passengers in the front of the boat who could be ejected over the bow and possibly struck by the gearcase or propeller.
- Loss of power and directional control in heavy seas, strong current or high winds.
- Loss of control when docking.

## Protecting People in the Water

### WHILE YOU ARE CRUISING

It is very difficult for a person standing or floating in the water to take quick action to avoid a boat heading in his/her direction, even at slow speed.



Always slow down and exercise extreme caution any time you are boating in an area where there might be people in the water.

Whenever a boat is moving (coasting) and the outboard gear shift is in neutral position, there is sufficient force by the water on the propeller to cause the propeller to rotate. This neutral propeller rotation can cause serious injury.

### WHILE BOAT IS STATIONARY

#### WARNING

**A spinning propeller, a moving boat, or any solid device attached to the boat can cause serious injury or death to swimmers. Stop the engine immediately whenever anyone in the water is near your boat.**

# GENERAL INFORMATION

Shift outboard into neutral and shut off the engine before allowing people to swim or be in the water near your boat.

## Passenger Safety Message - Pontoon Boats and Deck Boats

Whenever the boat is in motion, observe the location of all passengers. Do not allow any passengers to stand or use seats other than those designated for traveling faster than idle speed. A sudden reduction in boat speed, such as plunging into a large wave or wake, a sudden throttle reduction, or a sharp change of boat direction, could throw them over the front of the boat. Falling over the front of the boat between the two pontoons will position them to be run over by the outboard.

### BOATS HAVING AN OPEN FRONT DECK

No one should ever be on the deck in front of the fence while the boat is in motion. Keep all passengers behind the front fence or enclosure.

Persons on the front deck could easily be thrown overboard or persons dangling their feet over the front edge could get their legs caught by a wave and pulled into the water.

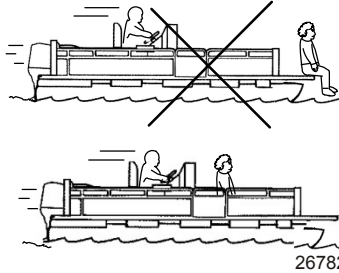

### WARNING

Sitting or standing in an area of the boat not designed for passengers at speeds above idle can cause serious injury or death. Stay back from the front end of deck boats or raised platforms and remain seated while the boat is in motion.

# GENERAL INFORMATION

## BOATS WITH FRONT MOUNTED, RAISED PEDESTAL FISHING SEATS

Elevated fishing seats are not intended for use when the boat is traveling faster than idle or trolling speed. Sit only in seats designated for traveling at faster speeds.

Any unexpected, sudden reduction in boat speed could result in the elevated passenger falling over the front of the boat.

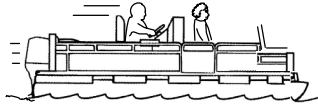
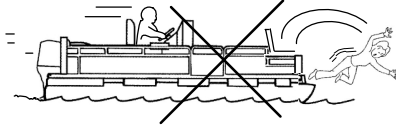

26783

## Wave and Wake Jumping

Operating recreational boats over waves and wake is a natural part of boating. However, when this activity is done with sufficient speed to force the boat hull partially or completely out of the water, certain hazards arise, particularly when the boat reenters the water.

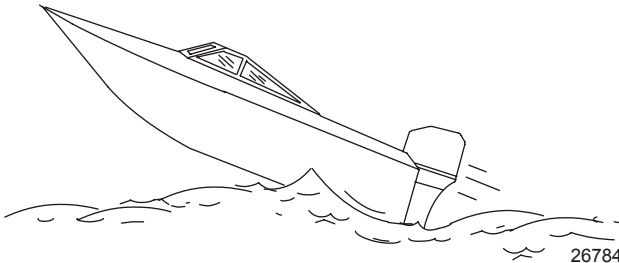

26784

The primary concern is the boat changing direction while in the midst of the jump. In such case, the landing may cause the boat to veer violently in a new direction. Such a sharp change in direction can cause occupants to be thrown out of their seats, or out of the boat.

## GENERAL INFORMATION

### **⚠ WARNING**

**Wave or wake jumping can cause serious injury or death from occupants being thrown within or out of the boat. Avoid wave or wake jumping whenever possible.**

There is another less common hazardous result from allowing your boat to launch off a wave or wake. If the bow of your boat pitches down far enough while airborne, upon water contact it may penetrate under the water surface and submarine for an instant. This will bring the boat to a nearly instantaneous stop and can send the occupants flying forward. The boat may also steer sharply to one side.

### **Impact with Underwater Hazards**

Reduce speed and proceed with caution whenever you drive a boat in shallow water areas, or in areas where you suspect underwater obstacles may exist which could be struck by the outboard or the boat bottom. **The most important thing you can do to help reduce injury or impact damage from striking a floating or underwater object is to control the boat speed. Under these conditions, boat speed should be kept to a minimum planing speed of 24 to 40 km/h (15 to 25 MPH).**

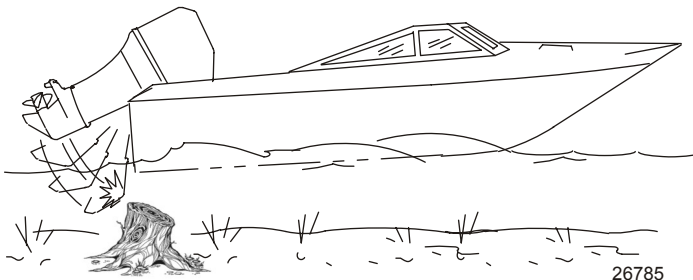

Striking a floating or underwater object could result in an infinite number of situations. Some of these situations could result in the following:

- Part of the outboard or the entire outboard could break loose and fly into the boat.

## GENERAL INFORMATION

- The boat could move suddenly in a new direction. Such a sharp change in direction can cause occupants to be thrown out of their seats or out of the boat.
- A rapid reduction in speed. This will cause occupants to be thrown forward, or even out of the boat.
- Impact damage to the outboard and/or boat.

Keep in mind, the most important thing you can do to help reduce injury or impact damage during an impact is control the boat speed. Boat speed should be kept to a minimum planing speed when driving in waters known to have underwater obstacles.

After striking a submerged object, stop the engine as soon as possible and inspect it for any broken or loose parts. If damage is present or suspected, the outboard should be taken to an authorized dealer for a thorough inspection and necessary repair.

The boat should also be checked for any hull fractures, transom fractures, or water leaks.

Operating a damaged outboard could cause additional damage to other parts of the outboard, or could affect control of the boat. If continued running is necessary, do so at greatly reduced speeds.

### WARNING

**Operating a boat or engine with impact damage can result in product damage, serious injury, or death. If the vessel experiences any form of impact, have an authorized Mercury Marine dealer inspect and repair the vessel or power package.**

## Exhaust Emissions

### BE ALERT TO CARBON MONOXIDE POISONING

Carbon monoxide is present in the exhaust fumes of all internal combustion engines. This includes the outboards, sterndrives, and inboard engines that propel boats, as well as the generators that power various boat accessories. Carbon monoxide is a deadly gas that is odorless, colorless, and tasteless.

Early symptoms of carbon monoxide poisoning which should not be confused with seasickness or intoxication, include headache, dizziness, drowsiness, and nausea.

# GENERAL INFORMATION

## WARNING

Carbon monoxide poisoning can lead to unconsciousness, brain damage, or death. Keep the boat well ventilated while at rest or underway and avoid prolonged exposure to carbon monoxide.

### GOOD VENTILATION

Ventilate passenger area, open side curtains or forward hatches to remove fumes.

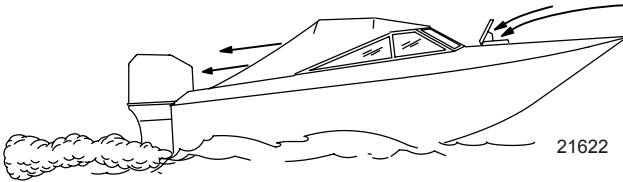

Example of desired air flow through the boat

### POOR VENTILATION

Under certain running and/or wind conditions, permanently enclosed or canvas enclosed cabins or cockpits with insufficient ventilation may draw in carbon monoxide. Install one or more carbon monoxide detectors in your boat.

Although the occurrence is rare, on a very calm day, swimmers and passengers in an enclosed area of a stationary boat that contains or is near a running engine may be exposed to a hazardous level of carbon monoxide.

# GENERAL INFORMATION

## WHILE BOAT IS STATIONARY

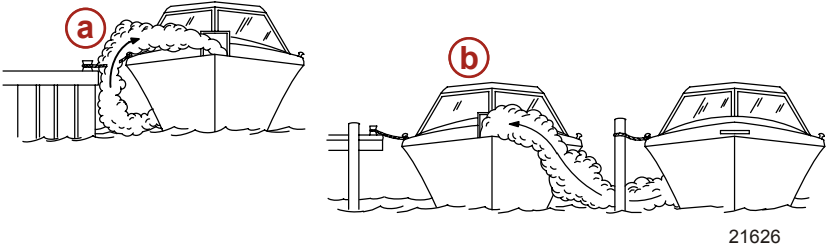

- a** - Running the engine when the boat is moored in a confined space
- b** - Mooring close to another boat that has its engine running

## WHILE BOAT IS MOVING



- a** - Running the boat with the trim angle of the bow too high
- b** - Running the boat with no forward hatches open

## Selecting Accessories for Your Outboard

Genuine Mercury Precision or Quicksilver Accessories have been specifically designed and tested for your outboard. These accessories are available from Mercury Marine dealers.

**IMPORTANT: Check with your dealer before installing accessories. The misuse of approved accessories or the use of nonapproved accessories can damage the product.**

Some accessories not manufactured or sold by Mercury Marine are not designed to be safely used with your outboard or outboard operating system. Acquire and read the installation, operation, and maintenance manuals for all your selected accessories.

# GENERAL INFORMATION

## Safe Boating Suggestions

In order to safely enjoy the waterways, familiarize yourself with local and other governmental boating regulations and restrictions, and consider the following suggestions.

**Use flotation devices.** Have an approved personal flotation device of suitable size for each person aboard (it is the law) and have it readily accessible.

**Do not overload your boat.** Most boats are rated and certified for maximum load (weight) capacities (refer to your boat capacity plate). If in doubt, contact your dealer or the boat's manufacturer.

**Perform safety checks and required maintenance.** Follow a regular schedule and ensure that all repairs are properly made.

**Know and obey all nautical rules and laws of the waterways.** Boat operators should complete a boating safety course. Courses are offered in the U.S.A. by 1) the U.S. Coast Guard Auxiliary, 2) the Power Squadron, 3) the Red Cross, and 4) your state boating law enforcement agency. Inquiries may be made to the Boating Hotline, 1-800-368-5647 or the Boat U.S. Foundation information number 1-800-336-BOAT.

**Make sure everyone in the boat is properly seated.** Do not allow anyone to sit or ride on any part of the boat that was not intended for such use. This includes the back of seats, gunwales, transom, bow, decks, raised fishing seats, any rotating fishing seat; or anywhere that an unexpected acceleration, sudden stopping, unexpected loss of boat control, or sudden boat movement could cause a person to be thrown overboard or into the boat.

**Never be under the influence of alcohol or drugs while boating (it is the law).** Alcohol or drug use impairs your judgment and greatly reduces your ability to react quickly.

**Prepare other boat operators.** Instruct at least one other person on board in the basics of starting and operating the outboard, and boat handling, in case the driver becomes disabled or falls overboard.

**Passenger boarding.** Stop the engine whenever passengers are boarding, unloading, or are near the back (stern) of the boat. Just shifting the outboard into neutral is not sufficient.



## GENERAL INFORMATION

**Be alert.** The operator of the boat is responsible by law to maintain a proper lookout by sight and hearing. The operator must have an unobstructed view particularly to the front. No passengers, load, or fishing seats should block the operator's view when operating the boat above idle speed.

**Never drive your boat directly behind a water-skier in case the skier falls.** As an example, your boat traveling at 40 km/h (25 MPH) will overtake a fallen skier 61 m (200 ft) in front of you in 5 seconds.

**Watch fallen skiers.** When using your boat for waterskiing or similar activities, always keep a fallen or down skier on the operator's side of the boat while returning to assist the skier. The operator should always have the down skier in sight and never back up to the skier or anyone in the water.

**Report accidents.** Boat operators are required by law to file a Boating Accident Report with their state boating law enforcement agency when their boat is involved in certain boating accidents. A boating accident must be reported if 1) there is loss of life or probable loss of life, 2) there is personal injury requiring medical treatment beyond first aid, 3) there is damage to boats or other property where the damage value exceeds \$500.00, or 4) there is complete loss of the boat. Seek further assistance from local law enforcement.

# GENERAL INFORMATION

## Recording Serial Number

It is important to record this number for future reference. The serial number is located on the outboard as shown.

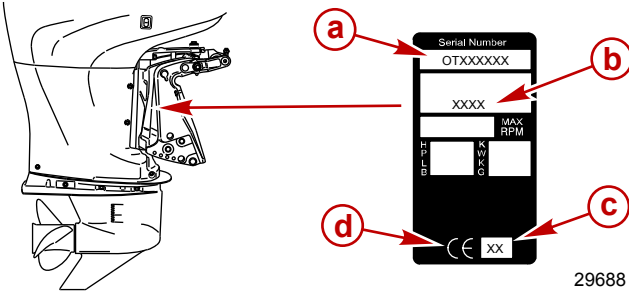

- a** - Serial number
- b** - Model designation
- c** - Year manufactured
- d** - Certified Europe Insignia (as applicable)

## 135/150/175/200 Specifications - International

Models	135/150/175/200
Horsepower	135/150/175/200
Kilowatts	101/112/130/149
Full throttle RPM range	135 HP - 5200–6400 150/175/200 HP - 5800–6400
Idle speed in neutral gear <sup>1</sup> .	650 RPM
Number of cylinders	4
Piston displacement	1,731 cc (105.6 cid)
Cylinder bore	82 mm (3.23 in.)
Stroke	82 mm (3.23 in.)
Recommended spark plug	NGK ILFR6G-E
Spark plug gap	0.8 mm (0.0315 in.)
Spark plug hex size	16 mm
Gear ratio	2.08:1
Recommended gasoline	Refer to <b>Fuel and Oil</b>

1. With engine fully warmed up.

## GENERAL INFORMATION

Models	135/150/175/200
Recommended oil	Refer to <b>Fuel and Oil</b>
Right hand rotation gearcase lubricant capacity	970 mL (32.8 fl oz)
Left hand rotation gearcase lubricant capacity	900 mL (30.4 fl oz)
Engine oil capacity with oil filter replacement	6.0 liters (6.3 US qt)
Required battery type	12 volt AGM (absorbed glass mat) battery
Required USA (SAE) starting battery rating	800 minimum marine cranking amps (MCA) with a minimum reserve capacity of 135 minutes RC25 rating
Required International (EN) starting battery rating	1000 minimum cold cranking amps (CCA) with a minimum of 180 amp hours (Ah)
Sound at Drivers Ear (ICOMIA 39/94)	83.2

# GENERAL INFORMATION

## Component Identification

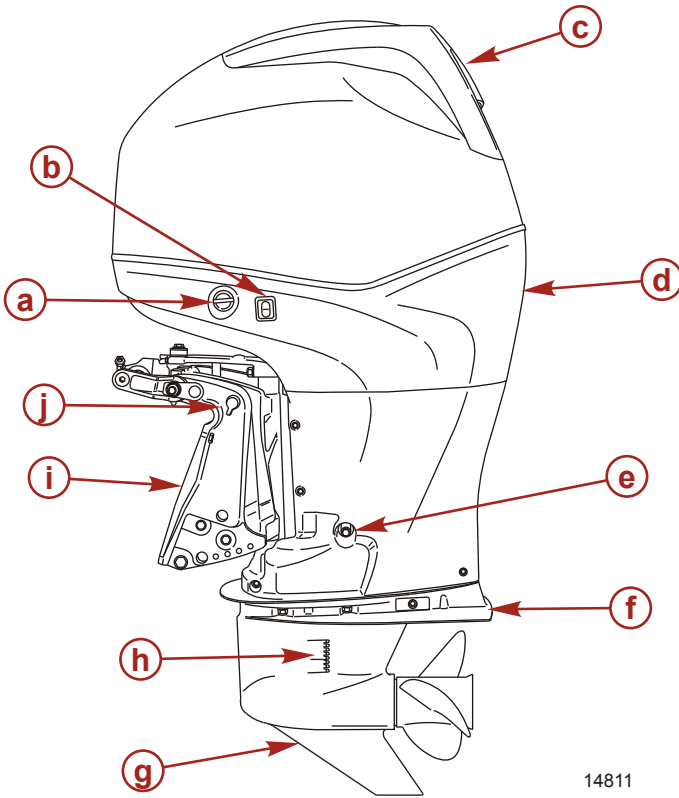

14811

- a** - Engine flush
- b** - Auxiliary tilt switch
- c** - Top cowl
- d** - Bottom cowl
- e** - Engine oil drain
- f** - Anti-ventilation plate
- g** - Gearcase
- h** - Cooling water intake holes
- i** - Transom brackets
- j** - Tilt lock level

# INSTALLATION

## Installing Outboard

### WARNING

Failure to correctly fasten the outboard could result in the outboard propelling off the boat transom resulting in property damage, serious injury, or death. Before operation, the outboard must be correctly installed with the required mounting hardware. Do not accelerate above idle speed in water that may contain underwater obstacles if the outboard is not attached to the transom correctly.

We strongly recommend that your dealer install your outboard and related accessories to ensure proper installation and good performance. If you install the outboard yourself, follow instructions in the Outboard Installation Manual which is provided with the outboard.

The outboard must be secured to the transom with the four 12.7 mm (1/2 in.) diameter mounting bolts and locknuts provided. Install two bolts through the upper set of holes and two bolts through the lower set of holes.

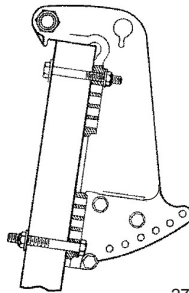

27746

# INSTALLATION

## Propeller Selection

For best all around performance from your outboard/boat combination, select a propeller that allows the engine to operate in the upper half of the recommended full throttle RPM range with the boat normally loaded (refer to **General Information - Specifications**). This RPM range allows for better acceleration while maintaining maximum boat speed.

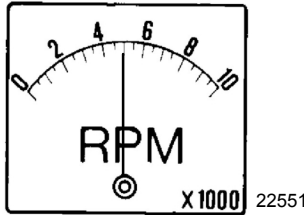

If changing conditions cause the RPM to drop below the recommended range, such as warmer, more humid weather, operation at higher elevations, increased boat load, or a dirty boat bottom/gearcase, a propeller change or cleaning may be required to maintain performance and ensure the outboards durability.

Check full-throttle RPM, using an accurate tachometer, with the engine trimmed out to a balanced-steering condition (steering effort equal in both directions) without causing the propeller to break loose.

# TRANSPORTING

## Trailing Boat/Outboard

Trailer your boat with the outboard tilted down in a vertical operating position.

If additional ground clearance is required, the outboard should be tilted up using an accessory outboard support device. Refer to your local dealer for recommendations. Additional clearance may be required for railroad crossings, driveways, and trailer bouncing.

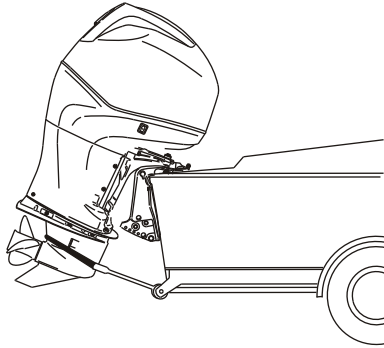

14825

**IMPORTANT: Do not rely on the power trim/tilt system or tilt support lever to maintain proper ground clearance for trailering. The outboard tilt support lever is not intended to support the outboard for trailering.**

Shift the outboard to forward gear. This prevents the propeller from spinning freely.

# FUEL AND OIL

## Fuel Recommendations

**IMPORTANT:** Use of improper gasoline can damage your engine. Engine damage resulting from the use of improper gasoline is considered misuse of the engine, and damage caused thereby will not be covered under the limited warranty.

### FUEL RATINGS

Mercury Marine engines will operate satisfactorily when using a major brand of unleaded gasoline meeting the following specifications:

**USA and Canada** - having a posted pump Octane Rating of 87 (R+M)/2 minimum. Premium gasoline (92 [R+M]/2 Octane) is also acceptable. Do not use leaded gasoline.

**Outside USA and Canada** - having a posted pump Octane Rating of 90 RON minimum. Premium gasoline (98 RON) is also acceptable. If unleaded gasoline is not available, use a major brand of leaded gasoline.

### USING REFORMULATED (OXYGENATED) GASOLINES (USA ONLY)

This type of gasoline is required in certain areas of the USA. The 2 types of oxygenates used in these fuels are alcohol (ethanol) or ether (MTBE or ETBE). If ethanol is the oxygenate that is used in the gasoline in your area, refer to **Gasolines Containing Alcohol**.

These reformulated gasolines are acceptable for use in your Mercury Marine engine.

### GASOLINES CONTAINING ALCOHOL

If the gasoline in your area contains either methanol (methyl alcohol) or ethanol (ethyl alcohol), you should be aware of certain adverse effects that can occur. These adverse effects are more severe with methanol. Increasing the percentage of alcohol in the fuel can also worsen these adverse effects.

Some of these adverse effects are caused because the alcohol in the gasoline can absorb moisture from the air, resulting in a separation of the water/alcohol from the gasoline in the fuel tank.



# FUEL AND OIL

The fuel system components on your Mercury Marine engine will withstand up to 10% alcohol content in the gasoline. We do not know what percentage your boat's fuel system will withstand. Contact your boat manufacturer for specific recommendations on the boat's fuel system components (fuel tanks, fuel lines, and fittings). Be aware that gasolines containing alcohol may cause increased:

- Corrosion of metal parts
- Deterioration of rubber or plastic parts
- Fuel permeation through rubber fuel lines
- Starting and operating difficulties

## WARNING

**Fuel leakage is a fire or explosion hazard, which can cause serious injury or death. Periodically inspect all fuel system components for leaks, softening, hardening, swelling, or corrosion, particularly after storage. Any sign of leakage or deterioration requires replacement before further engine operation.**

Because of possible adverse effects of alcohol in gasoline, it is recommended that only alcohol-free gasoline be used where possible. If only fuel containing alcohol is available, or if the presence of alcohol is unknown, increased inspection frequency for leaks and abnormalities is required.

**IMPORTANT:** When operating a Mercury Marine engine on gasoline containing alcohol, storage of gasoline in the fuel tank for long periods should be avoided. Long periods of storage, common to boats, create unique problems. In cars, alcohol-blend fuels normally are consumed before they can absorb enough moisture to cause trouble, but boats often sit idle long enough for phase separation to take place. In addition, internal corrosion may take place during storage if alcohol has washed protective oil films from internal components.

## Low Permeation Fuel Hose Requirement

Required for outboards manufactured for sale, sold, or offered for sale in the United States.

## FUEL AND OIL

- The Environmental Protection Agency (EPA) requires that any outboard manufactured after January 1, 2009 must use low permeation fuel hose for the primary fuel hose connecting the fuel tank to the outboard.
- Low permeation hose is USCG Type B1-15 or Type A1-15, defined as not exceeding  $15/\text{gm}^2/24 \text{ h}$  with CE 10 fuel at  $23 \text{ }^\circ\text{C}$  as specified in SAE J 1527 - marine fuel hose.

### Filling Fuel Tank

#### WARNING

**Avoid serious injury or death from a gasoline fire or explosion. Use caution when filling fuel tanks. Always stop the engine and do not smoke or allow open flames or sparks in the area while filling fuel tanks.**

Fill fuel tanks outdoors away from heat, sparks, and open flames. Remove portable fuel tanks from boat to refill them.

Always stop engine before refilling tanks.

Do not completely fill the fuel tanks. Leave approximately 10% of the tank volume unfilled. Fuel will expand in volume as its temperature rises and can leak under pressure if the tank is completely filled.

### PORTABLE FUEL TANK PLACEMENT IN THE BOAT

Place the fuel tank in the boat so the vent is higher than the fuel level under normal boat operating conditions.

### Engine Oil Recommendations

Mercury Verado NMMA FC-W certified synthetic blend 25W-50 multi-viscosity 4-Stroke Outboard Oil is recommended for general, all-temperature use. As an optional choice, Mercury or Quicksilver NMMA FC-W certified synthetic 25W-40 multi-viscosity 4-Stroke Outboard Oil may be used. If the recommended Mercury or Quicksilver NMMA FC-W certified oils are not available, a major brand of NMMA FC-W certified 4-stroke outboard oil of similar viscosity may be used.

## FUEL AND OIL

**IMPORTANT:** The use of non-detergent oils, multi-viscosity oils (other than Mercury or Quicksilver NMMA FC-W certified oil or a major brand NMMA FC-W certified oil), synthetic oils, low quality oils, or oils that contain solid additives are not recommended.

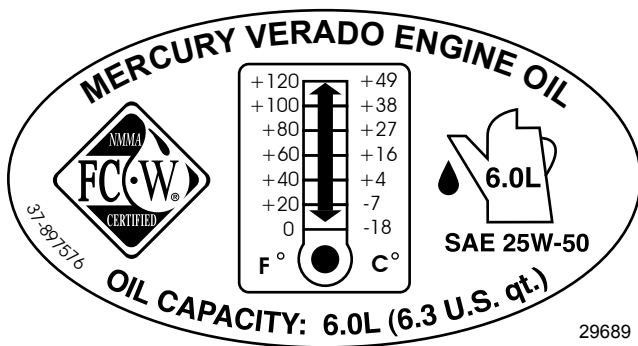

### Checking and Adding Engine Oil

**IMPORTANT:** Do not overfill. Tilt outboard out/up past vertical for approximately one minute to allow trapped oil to drain back to the oil sump. Tilt outboard to vertical (not tilted) position when checking engine oil. For accurate readings, check oil only when engine is cold or after engine has not run for at least an hour.

1. Before starting (cold engine) tilt outboard out/up past vertical to allow trapped oil to drain back to the oil sump. Allow outboard to remain tilted for approximately one minute.
2. Tilt outboard to vertical operating position.
3. Remove the top cowl. Refer to **Maintenance - Top Cowl Removal and Installation**.
4. Pull out the dipstick. Wipe the dipstick end with a clean rag or towel and push it back in all the way.
5. Pull the dipstick back out again and observe the oil level. Oil should be in the operating range (cross hatched region).

# FUEL AND OIL

**IMPORTANT:** Do not try to fill the oil level to the top of the operating range (cross hatched region). Oil level is correct as long as it appears in the operating range (cross hatched region).

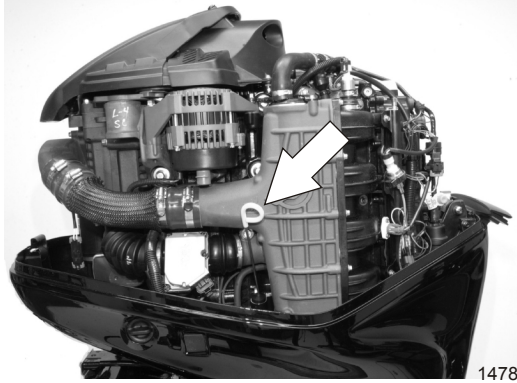
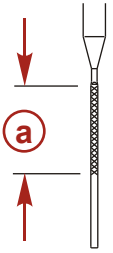

**a** - Oil level operating range

6. If the oil level is below the operating range (cross hatched region), remove the oil filler cap and add approximately 500 ml (16 oz.) of specified outboard motor oil. Allow a few minutes for the added oil to drain to the oil sump and recheck the dipstick. Repeat the process until oil level is on the operating range (cross hatched region). Do not try to fill to the upper end of the operation range (cross hatched region).

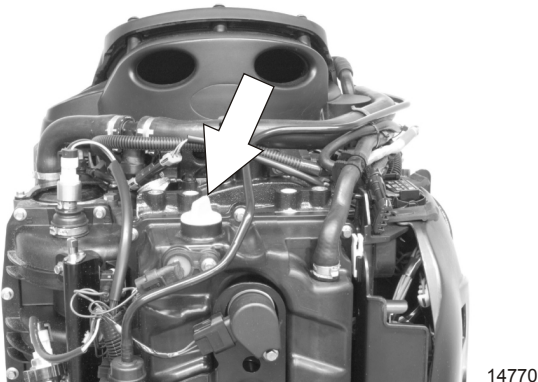

## FUEL AND OIL

**IMPORTANT:** Inspect oil for signs of contamination. Oil contaminated with water will have a milky color to it; oil contaminated with fuel will have a strong fuel smell. If contaminated oil is noticed, have the engine checked by your dealer.

7. Push the dipstick back in all the way.
8. Reinstall the oil fill cap hand tight.
9. Reinstall top cowl.

# FEATURES AND CONTROLS

## Panel Mount Control Features and Operation

1. Operation of shift and throttle is controlled by the movement of the control handle. Push the control handle forward from neutral to the first detent for forward gear. Continue pushing forward to increase speed. Pull the control handle back from neutral to the first detent for reverse gear. Continue pulling back to increase speed.

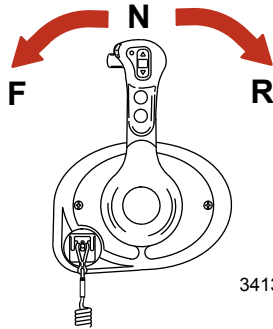

2. Shift lock - Pressing the shift lock allows the engine to shift. The shift lock must always be pressed when moving the control handle out of the neutral position.

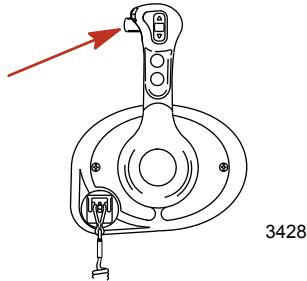

# FEATURES AND CONTROLS

- 3. Trim switch (if equipped) - Pressing the trim switch allows the engine to trim up or down.

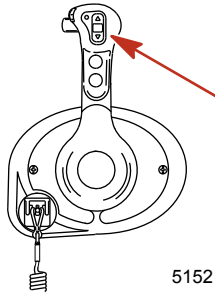

- 4. Throttle only button - Allows the boat operator to increase engine RPM for warm-up, without shifting the engine into gear. To engage throttle only, move the control handle into the neutral position. Press the throttle only button while moving the control handle ahead to the forward detent. The horn indicates throttle only is engaged. Advance throttle to increase engine RPM. To disengage, return control handle to neutral position. Engine RPM is limited to prevent engine damage.

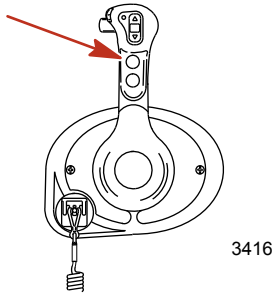

## FEATURES AND CONTROLS

5. Stop/start button - Allows the boat operator to start or stop the engine without using the ignition key. The ignition key must be in the "ON" position to start the engine.

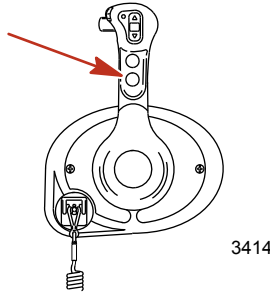

6. Lanyard stop switch - Turns the ignition off whenever the operator (when attached to the lanyard) moves far enough away from the operator's position to activate the switch.

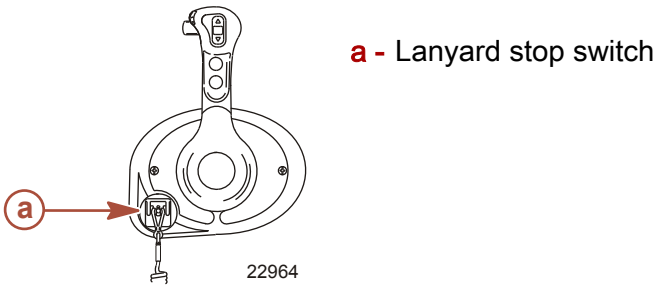

7. Control handle tension adjustment screw - This screw can be adjusted to increase or decrease the tension on the control handle (cover must be removed). This will help prevent unwanted motion of the handle in rough water. Turn screw clockwise to increase tension and counterclockwise to decrease tension. Adjust to tension desired.



# FEATURES AND CONTROLS

8. Detent tension adjustment screw - This screw can be adjusted to increase or decrease the effort to move control handle out of detent positions (cover must be removed). Turning screw clockwise will increase tension. Adjust to tension desired.

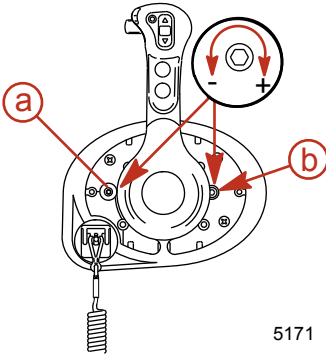

- a** - Detent tension adjustment screw
- b** - Control handle tension adjustment screw

5171

## Single Handle Console Control Features and Operation

1. Operation of shift and throttle is controlled by the movement of the control handle. Push the control handle forward from neutral to the first detent for forward gear. Continue pushing forward to increase speed. Pull the control handle back from neutral to the first detent for reverse gear. Continue pushing back to increase speed.

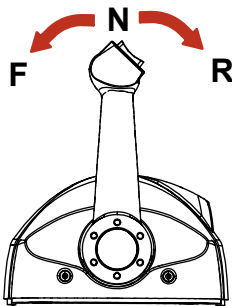

3417

## FEATURES AND CONTROLS

- Trim switch (if equipped) - Pressing the trim switch allows the engine to trim up or down.

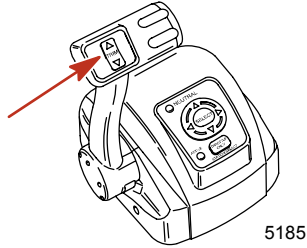

- Control handle tension adjustment screw - This screw can be adjusted to increase or decrease the tension on the control handle (cover must be removed). This will help prevent unwanted motion of the remote control handle in rough water. Turn the screw clockwise to increase tension and counterclockwise to decrease tension. Adjust to the desired tension.
- Detent tension adjustment screw - This screw can be adjusted to increase or decrease the effort to move control handle out of detent positions (cover must be removed). Turning the screw clockwise will increase tension. Adjust to the desired tension.

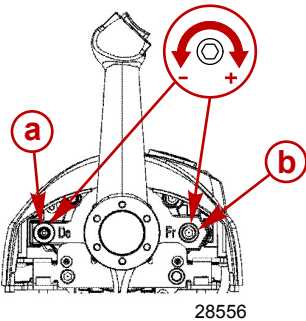

- a** - Detent tension adjustment screw
- b** - Control handle tension adjustment screw

- Arrow trackpad - Navigates through the System View on-screen function messages.

## FEATURES AND CONTROLS

6. Select button - Selects the System View on-screen options and confirm data entries. Holding the select button for two seconds will pause the slide show if selected in Favorites. Holding the select button for three seconds will activate the reset data function (except when in the slide show function). Holding the select button for five seconds or more will bring up the Home page.
7. Neutral LED - The neutral LED illuminates when engine is in neutral gear position. It also flashes when throttle only is activated.

**NOTE:** Gear position is determined by sensing the position of the shift actuator on the engine, not the position of the control handle.

8. Active LED - The active LED illuminates to show the remote control is active and ready for use.
9. Throttle only/station select button - Allows the boat operator to increase engine RPM for warm-up, without shifting the engine into gear. To engage throttle only, move the control handle into the neutral position. Press the throttle only button while moving the control handle ahead to the forward detent. The horn will sound once and the neutral light will start flashing. The horn will sound twice when throttle only is engaged. Advance throttle to increase engine RPM. To disengage, return control handle to neutral position and press the throttle only button. Engine RPM is limited to prevent engine damage. Pressing the station select button at an inactive helm initiates a helm transfer. Refer to **Helm Transfer**.

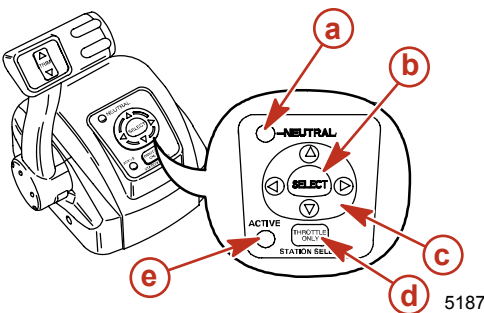

- a - Neutral LED
- b - Select button
- c - Arrow trackpad
- d - Throttle only/station select button
- e - Active LED

5187

# FEATURES AND CONTROLS

## HELM TRANSFER

### WARNING

Avoid serious injury or death from loss of boat control. The boat operator should never leave the active station while engine is in gear. Helm transfer should only be attempted while both stations are manned. One-person helm transfer should only be performed while engine is in neutral.

***NOTE:** Idle position is preferred when doing a helm transfer. If conditions do not allow the remote control to be placed at idle position, a helm transfer can be done while in gear.*

***NOTE:** The active light on the remote control will be illuminated at the helm that is in control of the engine.*

The helm transfer function allows the boat operator to select which helm is in control of engine operation. Pressing the throttle only/station select button two times allows engine control to be transferred to a new helm. When a helm transfer is initiated, the control will automatically start adjusting engine RPM and gear position to match the control handle setting at the new helm. Adjust the control handles to the desired throttle and gear position.

***NOTE:** There is a 10 second time frame to complete a helm transfer. If the helm transfer is not completed, the action will be cancelled and a double beep will sound. Pressing the throttle only/station select button again will reinitiate a helm transfer.*

1. Place active remote control lever to idle position.
2. Proceed to the inactive helm and position remote control lever to the idle position.

# FEATURES AND CONTROLS

3. Press throttle only/station select button two times. The "ACTIVE" light will illuminate to indicate the remote control is in control of the engine.

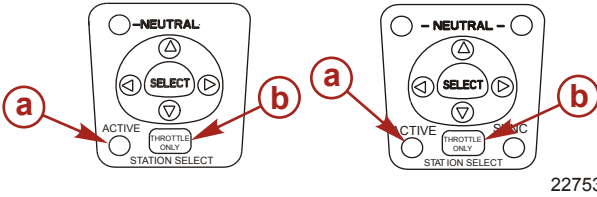

22753

- a** - Active light
- b** - Throttle only/station select button

4. The "ACTIVE" light will switch off at the original helm.

## Synchronizing Helms Prior to Helm Transfer

Pressing the throttle only/station select button one time allows the boat operator 10 seconds to match up the control handle setting at the new station with the handle setting that is at the old (to be inactive) station. If the handle is not matched, the neutral light will flash. The light blinks faster as the handle is nearing match position. Once the light stays on continuously, the handle is matched and the throttle only/station select button can be pressed again to complete the transfer. This completes the transfer process, and give control to the new station. If the helm transfer is not completed within 10 seconds, the helm transfer is cancelled.

# FEATURES AND CONTROLS

## Slim Binnacle Control Features and Operation

1. Operation of shift and throttle is controlled by the movement of the control handle. Push the control handle forward from neutral to the first detent for forward gear. Continue pushing forward to increase speed. Pull the control handle back from neutral to the first detent for reverse gear. Continue pushing back to increase speed.

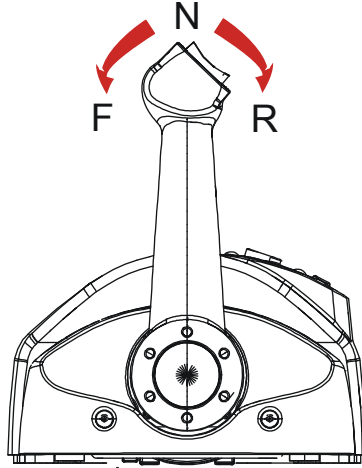

12871

2. Trim switch (if equipped) - Pressing the trim switch allows the engine to trim up or down.

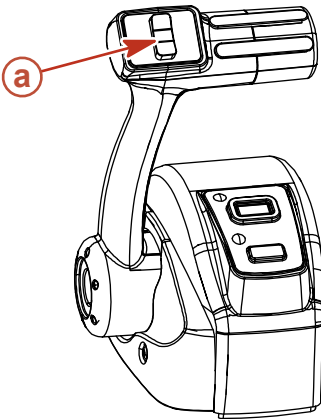

**a** - Trim switch

12874

## FEATURES AND CONTROLS

- Control handle tension adjustment screw - This screw can be adjusted to increase or decrease the tension on the control handle (cover must be removed). This will help prevent unwanted motion of the remote control handle in rough water. Turn the screw clockwise to increase tension and counterclockwise to decrease tension. Adjust to the desired tension.
- Detent tension adjustment screw - This screw can be adjusted to increase or decrease the effort to move control handle out of detent positions (cover must be removed). Turning the screw clockwise will increase tension. Adjust to the desired tension.

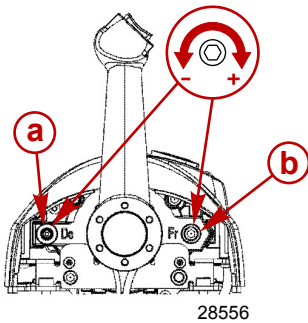

- a - Detent tension adjustment screw
- b - Control handle tension adjustment screw

- Start/stop button - Allows the boat operator to start or stop the engine without using the ignition key.
- Neutral LED - The neutral LED illuminates when engine is in neutral gear position. It also flashes when throttle only is activated.

**NOTE:** Gear position is determined by sensing the position of the shift actuator on the engine, not the position of the control handle.

- Active LED - The active LED illuminates to show the remote control is active and ready for use.

# FEATURES AND CONTROLS

8. Throttle only/station select button - Allows the boat operator to increase engine RPM for warm-up, without shifting the engine into gear. To engage throttle only, move the control handle into the neutral position. Press the throttle only button while moving the control handle ahead to the forward detent. The horn will sound once and the neutral light will start flashing. The horn will sound twice when throttle only is engaged. Advance throttle to increase engine RPM. To disengage, return control handle to neutral position and press the throttle only button. Engine RPM is limited to prevent engine damage. Pressing the station select button at an inactive helm initiates a helm transfer. Refer to **Helm Transfer**.

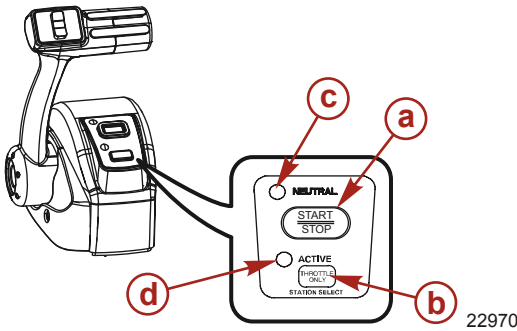

- a - Start/stop button
- b - Throttle only/  
station select  
button
- c - Neutral LED
- d - Active LED

## HELM TRANSFER

### WARNING

Avoid serious injury or death from loss of boat control. The boat operator should never leave the active station while engine is in gear. Helm transfer should only be attempted while both stations are manned. One-person helm transfer should only be performed while engine is in neutral.

**NOTE:** Idle position is preferred when doing a helm transfer. If conditions do not allow the remote control to be placed at idle position, a helm transfer can be done while in gear.

**NOTE:** The active light on the remote control will be illuminated at the helm that is in control of the engine.



# FEATURES AND CONTROLS

The helm transfer function allows the boat operator to select which helm is in control of engine operation. Pressing the throttle only/station select button two times allows engine control to be transferred to a new helm. When a helm transfer is initiated, the control will automatically start adjusting engine RPM and gear position to match the control handle setting at the new helm. Adjust the control handles to the desired throttle and gear position.

**NOTE:** *There is a 10 second time frame to complete a helm transfer. If the helm transfer is not completed, the action will be cancelled and a double beep will sound. Pressing the throttle only/station select button again will reinitiate a helm transfer.*

1. Place the active remote control lever to idle position.
2. Proceed to the inactive helm and position remote control lever to the idle position.
3. Press throttle only/station select button two times. The "ACTIVE" light will illuminate to indicate the remote control is in control of the engine.

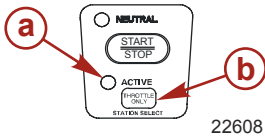

**a** - Active light

**b** - Throttle only/station select button

4. The "ACTIVE" light will switch off at the original helm.

## Synchronizing Helms Prior to Helm Transfer

Pressing the throttle only/station select button one time allows the boat operator 10 seconds to match up the control handle setting at the new station with the handle setting that is at the old (to be inactive) station. If the handle is not matched, the neutral light will flash. The light blinks faster as the handle is nearing match position. Once the light stays on continuously, the handle is matched and the throttle only/station select button can be pressed again to complete the transfer. This completes the transfer process, and gives control to the new station. If the helm transfer is not completed within 10 seconds, the helm transfer is cancelled.

# FEATURES AND CONTROLS

## Dual Handle Console Control Features and Operation

1. Operation of shift and throttle is controlled by the movement of the control handle. Push the control handle forward from neutral to the first detent for forward gear. Continue pushing forward to increase speed. Pull the control handle back from neutral to the first detent for reverse gear. Continue pulling back to increase speed.

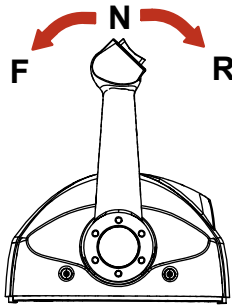

3417

2. Trim switch (if equipped) - Pressing the trim switch allows the engine to trim up or down.

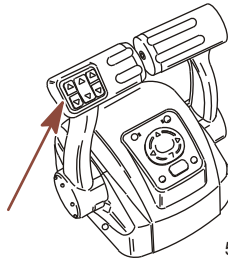

5269

3. Control handle tension adjustment screw - This screw can be adjusted to increase or decrease the tension on the control handle (cover must be removed). This will help prevent unwanted motion of the handle in rough water. Turn the screw clockwise to increase tension and counterclockwise to decrease tension. Adjust to the desired tension.

## FEATURES AND CONTROLS

4. Detent tension adjustment screw - This screw can be adjusted to increase or decrease the effort to move control handle out of detent positions (cover must be removed). Turning screw clockwise will increase tension. Adjust to the desired tension.

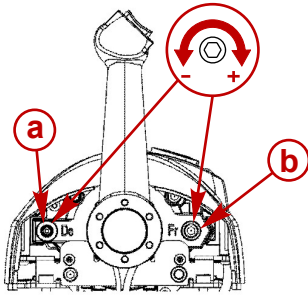

- a - Detent tension adjustment screw
- b - Control handle friction adjustment screw

5. Throttle only/station select button - Allows the boat operator to increase engine RPM for warm-up, without shifting the engine into gear. To engage throttle only, move the control handle into the neutral position. Press the throttle only button while moving the control handle ahead to the forward detent. The horn will sound once and the neutral light will start flashing. The horn will sound twice when throttle only is engaged. Advance throttle to increase engine RPM. To disengage, return control handle to neutral position and press the throttle only button. Engine RPM is limited to prevent engine damage. Pressing the station select button at an inactive helm initiates a helm transfer. Refer to **Helm Transfer**.
6. Arrow trackpad - Navigates through System View on-screen function messages.
7. Select button - Selects System View on-screen options and confirms data entries. Holding the select button for two seconds will pause the slide show if selected in Favorites. Holding the select button for three seconds will activate the reset data function (except when in the slide show function). Holding the select button for five seconds or more will bring up the Home page.
8. Neutral LEDs - The neutral LEDs illuminate when engines are in neutral gear position. The lights will flash when in throttle only mode.

# FEATURES AND CONTROLS

**NOTE:** Gear position is determined by sensing the position of the shift actuator on the engine, not the position of the control handle.

- 9. Active LED - The active LED illuminates to show the remote control is active and ready for use.
- 10. Sync LED - The sync LED illuminates when the RPM of the two engines are being synchronized by the DTS system.

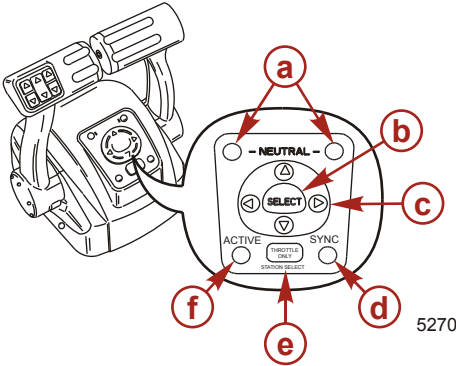

- a** - Neutral LEDs
- b** - Select button
- c** - Arrow trackpad
- d** - Sync LED
- e** - Throttle only/station select button
- f** - Active LED

## SYNCHRONIZING ENGINES

The auto synchronizing feature, when engaged, will automatically adjust all engine speeds to match the speed of the starboard engine.

Engine auto synchronization will automatically engage when engine speed is over 900 RPM for two seconds and remote control handles are positioned within 10% of each other. The "SYNC" light will turn on when the engines are synchronized. Auto synchronization will stay engaged up to 95% throttle opening. To disengage, move one or both control handles until they are more than 10% apart, reduce engine speed below 900 RPM, or increase engine speed beyond 95%.

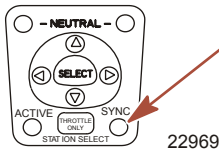

# FEATURES AND CONTROLS

## HELM TRANSFER

### WARNING

Avoid serious injury or death from loss of boat control. The boat operator should never leave the active station while engine is in gear. Helm transfer should only be attempted while both stations are manned. One-person helm transfer should only be performed while engine is in neutral.

***NOTE:** Idle position is preferred when doing a helm transfer. If conditions do not allow the remote control to be placed at idle position, a helm transfer can be done while in gear.*

***NOTE:** The active light on the remote control will be illuminated at the helm that is in control of the engine.*

The helm transfer function allows the boat operator to select which helm is in control of engine operation. Pressing the throttle only/ station select button two times allows engine control to be transferred to a new helm. When a helm transfer is initiated, the control will automatically start adjusting engine RPM and gear position to match the control handle setting at the new helm. Adjust the control handles to the desired throttle and gear position.

***NOTE:** There is a 10 second time frame to complete a helm transfer. If the helm transfer is not completed, the action will be cancelled and a double beep will sound. Pressing the throttle only/ station select button again will reinitiate a helm transfer.*

1. Place active remote control lever to idle position.
2. Proceed to the inactive helm and position remote control lever to the idle position.

# FEATURES AND CONTROLS

3. Press throttle only/station select button two times. The "ACTIVE" light will illuminate to indicate the remote control is in control of the engine.

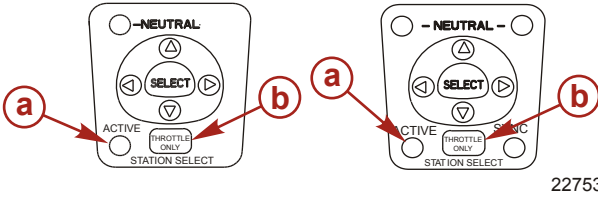

- a** - Active light
- b** - Throttle only/station select button

4. The "ACTIVE" light will switch off at the original helm.

## Synchronizing Helms Prior to Helm Transfer

Pressing the throttle only/station select button one time allows the boat operator 10 seconds to match up the control handle setting at the new station with the handle setting that is at the old (to be inactive) station. If the handle is not matched, the neutral light will flash. The light blinks faster as the handle is nearing match position. Once the light stays on continuously, the handle is matched and the throttle only/station select button can be pressed again to complete the transfer. This completes the transfer process, and give control to the new station. If the helm transfer is not completed within 10 seconds, the helm transfer is cancelled.

# FEATURES AND CONTROLS

## Dual Handle Console Control with CAN Trackpad Features and Operation

1. Operation of shift and throttle is controlled by the movement of the control handle. Push the control handle forward from neutral to the first detent for forward gear. Continue pushing the handle forward to increase speed. Pull the control handle back from neutral to the first detent for reverse gear. Continue pulling the handle back to increase speed.

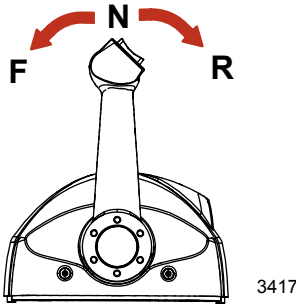

2. Trim switch (if equipped) - Pressing the trim switch allows the engine to trim up and down.

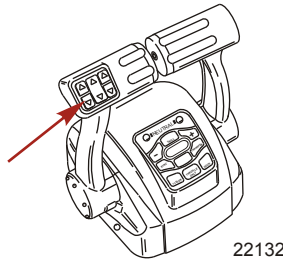

3. Neutral lights - The neutral lights illuminate when the engine is in neutral gear position. The lights will flash when the engine is in throttle only mode.

**NOTE:** Gear position is determined by the position of the shift actuator on the engine, not the position of the control handle.

## FEATURES AND CONTROLS

4. Troll button - Pressing the "TROLL" button activates troll control. The troll control feature allows the boat operator to set the engine speed for slow speed cruising or maneuvering. To activate, move the control handles into forward detent and press the button. Use the - or + buttons to decrease or increase speed, up to a maximum of 1000 RPM. If troll control is set at a desired speed and then shut off, the system remembers the set speed and will return to that speed when reengaged. To turn off the troll control press the "TROLL" button, move the throttle to a different speed, or shift the engine into neutral.
5. Transfer button - Pressing the "TRANSFER" button allows engine operation to be transferred from a different helm. Refer to **Helm Transfer**.
6. Dock button - Pressing the "DOCK" button initiates docking mode. Docking mode reduces throttle capacity to approximately 50% of normal throttle. To turn off docking mode, shift the engine into neutral and press the "DOCK" button.
7. Throttle only button - Allows the boat operator to increase engine RPM for warm-up, without shifting the engine into gear. To engage throttle only, move the control handle into the neutral position. Press the throttle only button and move the control handle ahead to the forward detent. The horn will sound once and the neutral light will start flashing. The horn will sound twice when throttle only is engaged. Advance throttle to increase engine RPM. To disengage, return control handle to neutral position and press the throttle only button. Engine RPM is limited to prevent engine damage.
8. 1 lever button - Pressing the "1 LEVER" button initiates single lever mode. Single lever mode enables the throttle and shift functions of both engines to be controlled by the port control handle. To turn off single lever mode, shift the engine into neutral and press the "1 LEVER" button.



# FEATURES AND CONTROLS

9. Sync button - Pressing the "SYNC" button turns off or on the auto synchronization feature. Refer to **Synchronizing Engines**.

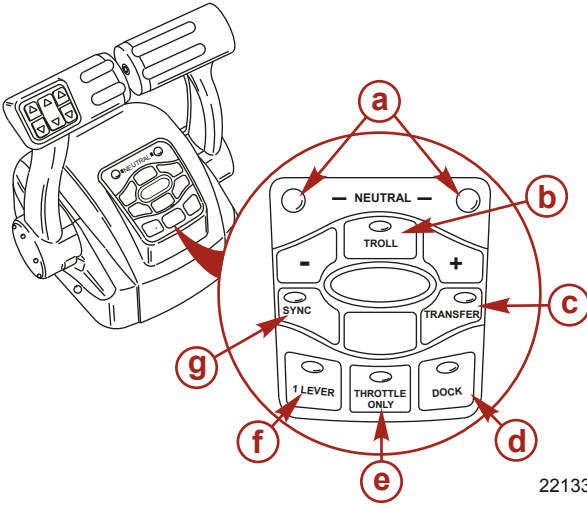

- a** - Neutral LEDS
- b** - Troll button
- c** - Transfer button
- d** - Dock button
- e** - Throttle only
- f** - 1 lever button
- g** - Sync button

10. Control handle tension adjustment screw - This screw can be adjusted to increase or decrease the tension on the control handle (cover must be removed). This will help prevent unwanted motion of the handle in rough water. Turn the screw clockwise to increase tension and counterclockwise to decrease tension. Adjust to tension desired.

# FEATURES AND CONTROLS

11. Detent tension adjustment screw - This screw can be adjusted to increase or decrease the effort to move control handle out of detent positions (cover must be removed). Turning the screw clockwise will increase tension. Adjust to tension desired.

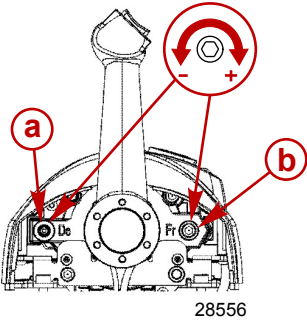

- a** - Detent tension adjustment screw
- b** - Control handle tension adjustment screw

28556

## SYNCHRONIZING ENGINES

The auto synchronizing feature, when engaged, will automatically adjust all engine speeds to match the speed of the starboard engine.

Press the "SYNC" button on the CAN trackpad to turn auto synchronization on or off. When the sync LED is yellow, the "SYNC" button has been pressed, but the conditions are not right for auto synchronization to engage. When the sync LED turns red, engine synchronization has been engaged. The engines will remain synchronized as long as engine speed is over 900 RPM for two seconds, remote control handles are positioned within 10% of each other, and the engines are below 95% throttle opening.

To disengage the auto synchronization feature, press the "SYNC" button.

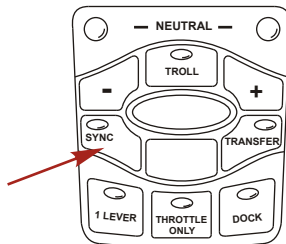

22590

# FEATURES AND CONTROLS

## HELM TRANSFER

### WARNING

Avoid serious injury or death from loss of boat control. The boat operator should never leave the active station while engine is in gear. Helm transfer should only be attempted while both stations are manned. One-person helm transfer should only be performed while engine is in neutral.

**NOTE:** *Neutral position is preferred when doing a station transfer. If conditions do not allow the remote control to be placed in the neutral position, a helm transfer can be done while in gear.*

The helm transfer function allows the boat operator to select which helm is in control of engine operation. Pressing the "TRANSFER" button two times allows engine control to be transferred to a new helm. When a helm transfer is initiated, the control will automatically start adjusting engine RPM and gear position to match the control handle setting at the new helm. Adjust the control handles to the desired throttle and gear position.

Once the "TRANSFER" button is pressed, the transfer LED will light up and one beep will sound. Press the "TRANSFER" button again to complete the helm transformation. When helm transformation is complete, another beep will sound and the transfer LED will turn off.

**NOTE:** *There is a 10 second time frame to complete a helm transfer. If the helm transfer is not completed, the action will be cancelled and a double beep will sound. Pressing the "TRANSFER" button again will reinitiate a helm transfer.*

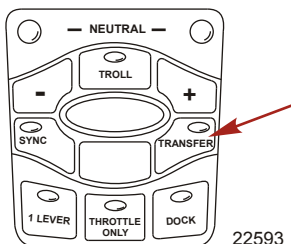

# FEATURES AND CONTROLS

## Synchronizing Helms Prior to Transfer

Pressing the "TRANSFER" button allows the boat operator 10 seconds to match up the control handle settings at the new helm with the handle settings that are at the old (to be inactive) helm. If the handles are not matched, the neutral lights will flash. The light blinks faster as the handles are nearing match position. Once the light stays on continuously, the handles are matched and the button can be pressed again to complete the transfer. This completes the transfer process, and gives control to the new station. If the helm transfer is not completed within 10 seconds, the action will be cancelled.

## Shadow Mode Control Features and Operation

### TRIPLE ENGINE THROTTLE AND SHIFT OPERATION

Movement of the handles on the remote control allows the boat operator to control the engine throttle speed and gear shift positions of all three engines.

The throttle and shift function is dependant on what engines are running. Refer to the following table.

Port Engine	Center Engine	Starboard Engine	Control Handle Function
Running	Running	Running	Port engine throttle and shift = controlled by port control handle
			Starboard engine throttle and shift = controlled by starboard control handle
			Center engine throttle = average of port and starboard engines
			Center engine shift = neutral unless both engines are in the same gear
Running	Running	Off	Port and center engine throttle and shift = controlled by port control handle
Off	Running	Running	Starboard and center engine throttle and shift = controlled by starboard control handle

## FEATURES AND CONTROLS

Port Engine	Center Engine	Starboard Engine	Control Handle Function
Running	Off	Running	Port engine throttle and shift = controlled by port control handle
			Starboard engine throttle and shift = controlled by starboard control handle
Running	Off	Off	Port engine throttle and shift = controlled by port control handle
Off	Off	Running	Starboard engine throttle and shift = controlled by starboard control handle
Off (ignition key switch turned on)	Running	Off (ignition key switch turned on)	Center engine throttle and shift = neutral/idle unless both control handles are in the same gear

Turning off one of the outer engines while underway will cause the center engine to go into forced neutral/idle. Operation to the center engine can be restored by moving the control handle of the functioning outer engine back into neutral position and then reengaging. The center engine speed and gear shift will then be controlled by the functioning outer engine.

Turning off the center engine while underway will have no effect on the operation of the outer engines.

If a failure should occur while underway which causes one of the outer engines into forced neutral/idle condition, the center engine will also be forced to neutral/idle. Operation to the center engine can be restored by moving the control handle of the functioning outer engine back into neutral and then reengaging.

### QUAD ENGINE THROTTLE AND SHIFT OPERATION

Movement of the handles on the remote control allows the boat operator to control the engine throttle speed and gear shift positions of all four engines.

The throttle and shift function is dependent on what engines are running. Refer to the following table.

# FEATURES AND CONTROLS

Port Outer Engine	Port Inner Engine	Starboard Inner Engine	Starboard Outer Engine	Control Handle Function
Running	Running	Running	Running	Port inner and outer engines throttle and shift = controlled by port control handle
				Starboard inner and outer engines throttle and shift = controlled by starboard control handle
Running	Running	Off	Off	Port inner and outer engine throttle and shift = controlled by port control handle
Off	Off	Running	Running	Starboard inner and outer engine throttle and shift = controlled by starboard control handle
Off (ignition key switch turned on)	Running	Running	Running	Port inner engine throttle and shift = controlled by port control handle
Running	Running	Running	Off (ignition key switch turned on)	Starboard inner engine throttle and shift = controlled by starboard control handle
Off (ignition key switch turned off)	Running	Running	Running	Port inner engine throttle and shift = controlled by starboard control handle
Running	Running	Running	Off (ignition key switch turned off)	Starboard inner engine throttle and shift = controlled by port control handle
Running	Off	Off	Running	Port outer engine throttle and shift = controlled by port control handle
				Starboard outer engine throttle and shift = controlled by starboard control handle

## FEATURES AND CONTROLS

Port Outer Engine	Port Inner Engine	Starboard Inner Engine	Starboard Outer Engine	Control Handle Function
Off (ignition key switch turned on)	Running	Running	Off (ignition key switch turned on)	Port inner engine throttle and shift = controlled by port control handle
				Starboard inner engine throttle and shift = controlled by starboard control handle

Turning off the starboard outer engine while underway will cause the starboard inner engine to go into forced neutral/idle. Operation to the inner engine can be restored by turning the starboard outer engine ignition key to the on position and moving the starboard control handle back into neutral position and then reengaging. The inner engine speed and gear shift will then be controlled by the starboard control handle.

Turning off the port outer engine while underway will cause the port inner engine to go into forced neutral/idle. Operation to the inner engine can be restored by turning the port outer engine ignition key to the on position and moving the port control handle back into neutral position and then reengaging. The inner engine speed and gear shift will then be controlled by the port control handle.

Turning off one of the inner engines while underway will have no effect on the operation of the outer engines.

If a failure should occur while underway which causes the starboard outer engines into forced neutral/idle condition, the inner starboard engine will also be forced to neutral/idle. Operation to the inner engine can be restored by moving the starboard control handle back into neutral and then reengaging.

If a failure should occur while underway which causes the port outer engines into forced neutral/idle condition, the inner port engine will also be forced to neutral/idle. Operation to the inner engine can be restored by moving the port control handle back into neutral and then reengaging.

# FEATURES AND CONTROLS

## TRIM SWITCH AND KEY PAD FEATURES

1. Trim switch (if equipped) - Operates the trim for all engines. An accessory trim switch panel is required for trimming engines individually.

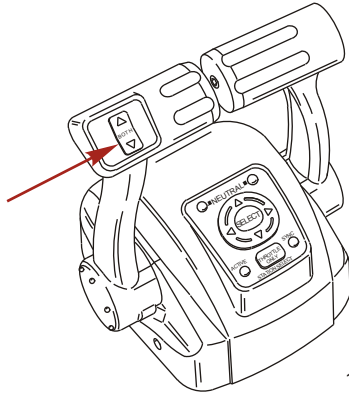

13853

2. Throttle only/station select button - Allows the boat operator to increase engine RPM for warm-up, without shifting the engine into gear. To engage throttle only, move the control handle into the neutral position. Press the throttle only button while moving the control handle ahead to the forward detent. The horn will sound once and the neutral light will start flashing. The horn will sound twice when throttle only is engaged. Advance throttle to increase engine RPM. To disengage, return control handle to neutral position and press the throttle only button. Engine RPM is limited to prevent engine damage. Pressing the station select button at an inactive helm initiates a helm transfer. Refer to **Helm Transfer**.
3. Arrow trackpad - Navigates through System View on-screen function messages.
4. Select button - Selects System View on-screen options and confirm data entries. Holding the select button for two seconds will pause the slide show if selected in Favorites. Holding the select button for three seconds will activate the reset data function (except when in the slide show function). Holding the select button for five seconds or more will bring up the Home page.



# FEATURES AND CONTROLS

5. Neutral LEDs - The neutral LEDs illuminate when engines are in neutral gear position. The lights will flash when in throttle only mode.

**NOTE:** Gear position is determined by sensing the position of the shift actuator on the engine, not the position of the control handle.

6. Active LED - The active LED illuminates to show the remote control is active and ready for use.

7. Sync LED - The "SYNC" LED illuminates when the RPM of the engines are being synchronized by the DTS system.

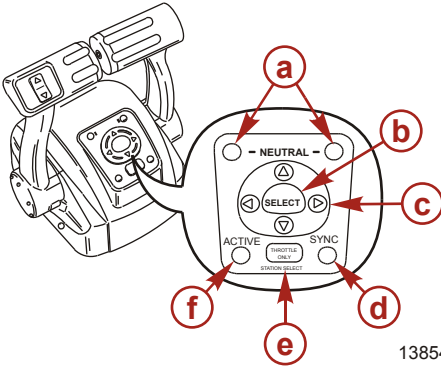

- a - Neutral LEDs
- b - Select button
- c - Arrow trackpad
- d - Sync LED
- e - Throttle only/station select button
- f - Active LED

## SYNCHRONIZING ENGINES

The auto synchronizing feature, when engaged, will automatically adjust all engine speeds to match the speed of the starboard engine.

Engine auto synchronization will automatically engage when engine speed is over 900 RPM for two seconds and remote control handles are positioned within 10% of each other. The "SYNC" light will turn on when the engines are synchronized. Auto synchronization will stay engaged up to 95% throttle opening. To disengage, move one or both control handles until they are more than 10% apart, reduce engine speed below 900 RPM, or increase engine speed beyond 95%.

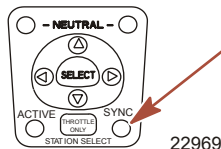

# FEATURES AND CONTROLS

## HELM TRANSFER

### WARNING

Avoid serious injury or death from loss of boat control. The boat operator should never leave the active station while engine is in gear. Helm transfer should only be attempted while both stations are manned. One-person helm transfer should only be performed while engine is in neutral.

***NOTE:** Idle position is preferred when doing a helm transfer. If conditions do not allow the remote control to be placed at idle position, a helm transfer can be done while in gear.*

***NOTE:** The active light on the remote control will be illuminated at the helm that is in control of the engine.*

The helm transfer function allows the boat operator to select which helm is in control of engine operation. Pressing the throttle only/station select button two times allows engine control to be transferred to a new helm. When a helm transfer is initiated, the control will automatically start adjusting engine RPM and gear position to match the control handle setting at the new helm. Adjust the control handles to the desired throttle and gear position.

***NOTE:** There is a 10 second time frame to complete a helm transfer. If the helm transfer is not completed, the action will be cancelled and a double beep will sound. Pressing the throttle only/station select button again will reinitiate a helm transfer.*

1. Place active remote control lever to idle position.
2. Proceed to the inactive helm and position remote control lever to the idle position.

# FEATURES AND CONTROLS

3. Press throttle only/station select button two times. The "ACTIVE" light will illuminate to indicate the remote control is in control of the engine.

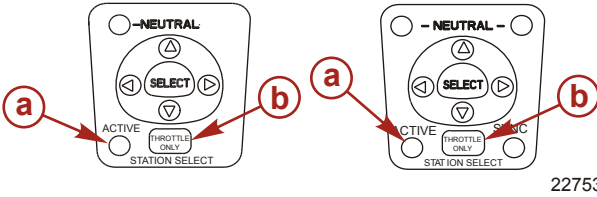

**a** - Active light

**b** - Throttle only/station select button

4. The "ACTIVE" light will switch off at the original helm.

## Synchronizing Helms Prior to Helm Transfer

Pressing the throttle only/station select button one time allows the boat operator 10 seconds to match up the control handle setting at the new station with the handle setting that is at the old (to be inactive) station. If the handle is not matched, the neutral light will flash. The light blinks faster as the handle is nearing match position. Once the light stays on continuously, the handle is matched and the throttle only/station select button can be pressed again to complete the transfer. This completes the transfer process, and give control to the new station. If the helm transfer is not completed within 10 seconds, the helm transfer is cancelled.

## Shadow Mode Control with CAN Trackpad Features and Operation

### TRIPLE ENGINE THROTTLE AND SHIFT OPERATION

Movement of the handles on the remote control allows the boat operator to control the engine throttle speed and gear shift positions of all three engines.

The throttle and shift function is dependant on what engines are running. Refer to the following table.

## FEATURES AND CONTROLS

Port Engine	Center Engine	Starboard Engine	Control Handle Function
Running	Running	Running	Port engine throttle and shift = controlled by port control handle
			Starboard engine throttle and shift = controlled by starboard control handle
			Center engine throttle = average of port and starboard engines
			Center engine shift = neutral unless both engines are in the same gear
Running	Running	Off	Port and center engine throttle and shift = controlled by port control handle
Off	Running	Running	Starboard and center engine throttle and shift = controlled by starboard control handle
Running	Off	Running	Port engine throttle and shift = controlled by port control handle
			Starboard engine throttle and shift = controlled by starboard control handle
Running	Off	Off	Port engine throttle and shift = controlled by port control handle
Off	Off	Running	Starboard engine throttle and shift = controlled by starboard control handle
Off (ignition key switch turned on)	Running	Off (ignition key switch turned on)	Center engine throttle and shift = neutral/idle unless both control handles are in the same gear

Turning off one of the outer engines while underway will cause the center engine to go into forced neutral/idle. Operation to the center engine can be restored by moving the control handle of the functioning outer engine back into neutral position and then reengaging. The center engine speed and gear shift will then be controlled by the functioning outer engine.

Turning off the center engine while underway will have no effect on the operation of the outer engines.

## FEATURES AND CONTROLS

If a failure should occur while underway which causes one of the outer engines into forced neutral/idle condition, the center engine will also be forced to neutral/idle. Operation to the center engine can be restored by moving the control handle of the functioning outer engine back into neutral and then reengaging.

### QUAD ENGINE THROTTLE AND SHIFT OPERATION

Movement of the handles on the remote control allows the boat operator to control the engine throttle speed and gear shift positions of all four engines.

The throttle and shift function is dependent on what engines are running. Refer to the following table.

Port Outer Engine	Port Inner Engine	Starboard Inner Engine	Starboard Outer Engine	Control Handle Function
Running	Running	Running	Running	Port inner and outer engines throttle and shift = controlled by port control handle
				Starboard inner and outer engines throttle and shift = controlled by starboard control handle
Running	Running	Off	Off	Port inner and outer engine throttle and shift = controlled by port control handle
Off	Off	Running	Running	Starboard inner and outer engine throttle and shift = controlled by starboard control handle
Off (ignition key switch turned on)	Running	Running	Running	Port inner engine throttle and shift = controlled by port control handle
Running	Running	Running	Off (ignition key switch turned on)	Starboard inner engine throttle and shift = controlled by starboard control handle

## FEATURES AND CONTROLS

Port Outer Engine	Port Inner Engine	Starboard Inner Engine	Starboard Outer Engine	Control Handle Function
Off (ignition key switch turned off)	Running	Running	Running	Port inner engine throttle and shift = controlled by starboard control handle
Running	Running	Running	Off (ignition key switch turned off)	Starboard inner engine throttle and shift = controlled by port control handle
Running	Off	Off	Running	Port outer engine throttle and shift = controlled by port control handle
				Starboard outer engine throttle and shift = controlled by starboard control handle
Off (ignition key switch turned on)	Running	Running	Off (ignition key switch turned on)	Port inner engine throttle and shift = controlled by port control handle
				Starboard inner engine throttle and shift = controlled by starboard control handle

Turning off the starboard outer engine while underway will cause the starboard inner engine to go into forced neutral/idle. Operation to the inner engine can be restored by turning the starboard outer engine ignition key to the on position and moving the starboard control handle back into neutral position and then reengaging. The inner engine speed and gear shift will then be controlled by the starboard control handle.

Turning off the port outer engine while underway will cause the port inner engine to go into forced neutral/idle. Operation to the inner engine can be restored by turning the port outer engine ignition key to the on position and moving the port control handle back into neutral position and then reengaging. The inner engine speed and gear shift will then be controlled by the port control handle.

# FEATURES AND CONTROLS

Turning off one of the inner engines while underway will have no effect on the operation of the outer engines.

If a failure should occur while underway which causes the starboard outer engines into forced neutral/idle condition, the inner starboard engine will also be forced to neutral/idle. Operation to the inner engine can be restored by moving the starboard control handle back into neutral and then reengaging.

If a failure should occur while underway which causes the port outer engines into forced neutral/idle condition, the inner port engine will also be forced to neutral/idle. Operation to the inner engine can be restored by moving the port control handle back into neutral and then reengaging.

## TRIM SWITCH AND KEY PAD FEATURES

1. Trim switch (if equipped) - Operates the trim for all engines. An accessory trim switch panel is required for trimming engines individually.

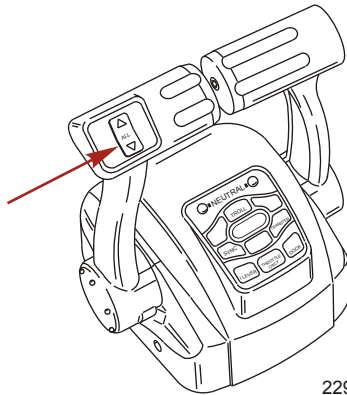

22943

2. Neutral lights - The neutral lights illuminate when the engine is in neutral gear position. The lights will flash when the engine is in throttle only mode.

**NOTE:** Gear position is determined by the position of the shift actuator on the engine, not the position of the control handle.

## FEATURES AND CONTROLS

3. Troll button - Pressing the "TROLL" button activates troll control. The troll control feature allows the boat operator to set the engine speed for slow speed cruising or maneuvering. To activate, move the control handles into forward detent and press the button. Use the - or + buttons to decrease or increase speed, up to the maximum calibrated set point. If troll control is set at a desired speed and then shut off, the system remembers the set speed and will return to that speed when reengaged. To turn off the troll control press the "TROLL" button, move the throttle to a different speed, or shift the engine into neutral.
4. Transfer button - Pressing the "TRANSFER" button allows engine operation to be transferred to a different helm. Refer to **Helm Transfer**.
5. Dock button - Pressing the "DOCK" button initiates docking mode. Docking mode reduces throttle capacity to approximately 50% of normal throttle. To turn off docking mode, shift the engine into neutral and press the "DOCK" button.
6. Throttle only button - Allows the boat operator to increase engine RPM for warm-up, without shifting the engine into gear. To engage throttle only, move the control handle into the neutral position. Press the throttle only button while moving the control handle ahead to the forward detent. The horn will sound once and the neutral light will start flashing. The horn will sound twice when throttle only is engaged. Advance throttle to increase engine RPM. To disengage, return control handle to neutral position and press the throttle only button. Engine RPM is limited to prevent engine damage.
7. 1 lever button - Pressing the "1 LEVER" button initiates single lever mode. Single lever mode enables the throttle and shift functions of both engines to be controlled by the port control handle. To turn off single lever mode, shift the engine into neutral and press the "1 LEVER" button.



# FEATURES AND CONTROLS

8. Sync button - Pressing the "SYNC" button turns off or on the auto synchronization feature. Refer to **Synchronizing Engines**.

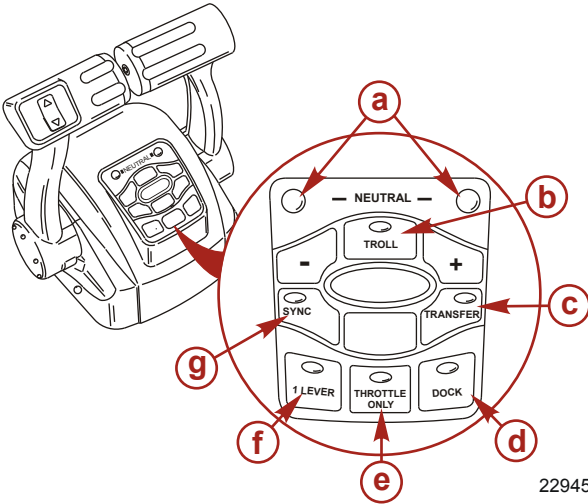

- a** - Neutral LEDs
- b** - Troll button
- c** - Transfer button
- d** - Dock button
- e** - Throttle only
- f** - 1 lever button
- g** - Sync button

9. Control handle tension adjustment screw - This screw can be adjusted to increase or decrease the tension on the control handle (cover must be removed). This will help prevent unwanted motion of the handle in rough water. Turn the screw clockwise to increase tension and counterclockwise to decrease tension. Adjust to tension desired.

# FEATURES AND CONTROLS

10. Detent tension adjustment screw - This screw can be adjusted to increase or decrease the effort to move control handle out of detent positions (cover must be removed). Turning the screw clockwise will increase tension. Adjust to tension desired.

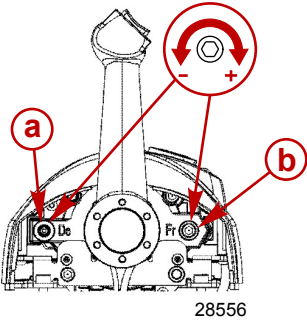

- a** - Detent tension adjustment screw
- b** - Control handle tension adjustment screw

28556

## SYNCHRONIZING ENGINES

The auto synchronizing feature, when engaged, will automatically adjust all engine speeds to match the speed of the starboard engine.

Press the "SYNC" button on the CAN trackpad to turn auto synchronization on or off. When the sync LED is yellow, the "SYNC" button has been pressed, but the conditions are not right for auto synchronization to engage. When the sync LED turns red, engine synchronization has been engaged. The engines will remain synchronized as long as engine speed is over 900 RPM for two seconds, remote control handles are positioned within 10% of each other, and the engines are below 95% throttle opening.

To disengage the auto synchronization feature, press the "SYNC" button.

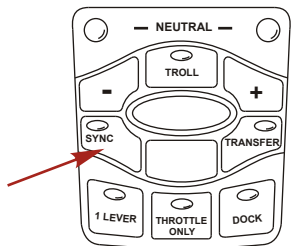

22590

# FEATURES AND CONTROLS

## HELM TRANSFER

### WARNING

Avoid serious injury or death from loss of boat control. The boat operator should never leave the active station while engine is in gear. Helm transfer should only be attempted while both stations are manned. One-person helm transfer should only be performed while engine is in neutral.

**NOTE:** *Neutral position is preferred when doing a station transfer. If conditions do not allow the remote control to be placed in the neutral position, a helm transfer can be done while in gear.*

The helm transfer function allows the boat operator to select which helm is in control of engine operation. Pressing the "TRANSFER" button two times allows engine control to be transferred to a new helm. When a helm transfer is initiated, the control will automatically start adjusting engine RPM and gear position to match the control handle setting at the new helm. Adjust the control handles to the desired throttle and gear position.

Once the "TRANSFER" button is pressed, the transfer LED will light up and one beep will sound. Press the "TRANSFER" button again to complete the helm transformation. When helm transformation is complete, another beep will sound and the transfer LED will turn off.

**NOTE:** *There is a 10 second time frame to complete a helm transfer. If the helm transfer is not completed, the action will be cancelled and a double beep will sound. Pressing the "TRANSFER" button again will reinitiate a helm transfer.*

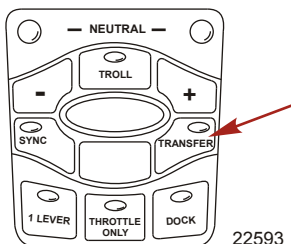

# FEATURES AND CONTROLS

## Synchronizing Helms Prior to Transfer

Pressing the "TRANSFER" button allows the boat operator 10 seconds to match up the control handle settings at the new helm with the handle settings that are at the old (to be inactive) helm. If the handles are not matched, the neutral lights will flash. The light blinks faster as the handles are nearing match position. Once the light stays on continuously, the handles are matched and the button can be pressed again to complete the transfer. This completes the transfer process, and gives control to the new station. If the helm transfer is not completed within 10 seconds, the action will be cancelled.

## Warning System

### WARNING HORN SIGNALS

When the key switch is turned to the "ON" position, the horn (located on the command module harness) will turn on for a moment as a test to indicate the horn is working.

There are two types of warning horns to alert the operator of an active problem within the engine's operating system.

1. **Continuous six second beep:** Indicates a critical engine condition. Depending on the condition, the Engine Guardian System may engage and protect the engine by limiting its power. You should return to port immediately and contact your servicing dealer.
2. **Intermittent short beeps for six seconds:** Indicates a noncritical engine condition. This condition does not require immediate attention. You may continue using your boat, however, depending on the nature of the problem, the engine's power may be limited by the Engine Guardian System (see Engine Guardian System following) to protect the engine. You should contact your servicing dealer at your earliest convenience.

It is important to note that in either of the above scenarios, the horn will only sound one time. If you key the engine off and restart it, the horn will sound again, one time, if the fault is still present. For visual display of the specific engine functions and additional engine data, refer to SmartCraft Product information, following.

## FEATURES AND CONTROLS

A few of the noncritical conditions indicated by the intermittent short beeps for six seconds can be corrected by the operator. These operator correctable conditions are as follows:

- Water in the engine mounted fuel filter. Refer to **Maintenance – Water Separating Fuel Filter**.
- Cooling system (water pressure or engine temperature) problem. Stop the engine and check the water intake holes in the lower unit for obstruction.
- Low engine oil level. Refer to **Fuel and Oil – Checking and Adding Engine Oil**.

### ENGINE GUARDIAN SYSTEM

The Engine Guardian System monitors the critical sensors on the engine for any early indications of problems. Engine Guardian is functional whenever your engine is operating, so you never have to be concerned about whether or not you are protected. The system will respond to a problem by sounding the warning horn for six seconds and/or reducing engine power in order to provide engine protection.

If the Guardian System has been activated, reduce throttle speed. The problem will need to be identified and corrected, if possible. The system must be reset before the engine will operate at higher speeds. Moving the throttle lever back to the idle position will reset the system.

### SMARTCRAFT PRODUCT

A Mercury SmartCraft System instrument package can be purchased for this outboard. A few of the functions the instrument package will display are engine RPM, coolant temperature, oil pressure, water pressure, battery voltage, fuel consumption, and engine operating hours.

The SmartCraft Instrument package will also aid in Engine Guardian diagnostics. The SmartCraft Instrument package will display critical engine alarm data and potential problems.

# FEATURES AND CONTROLS

## Power Trim and Tilt

The outboard has a trim/tilt control called power trim. This enables the operator to easily adjust the position of the outboard by pressing the trim switch. Moving the outboard in closer to the boat transom is called trimming in or down. Moving the outboard further away from the boat transom is called trimming out or up. The term trim generally refers to the adjustment of the outboard within the first 20° range of travel. This is the range used while operating the boat on plane. The term tilt is generally used when referring to adjusting the outboard further up out of the water. With the engine turned off and ignition switch turned on, the outboard can be tilted out of the water. At low idle speed, the outboard can also be tilted up past the trim range to permit, for example, shallow water operation.

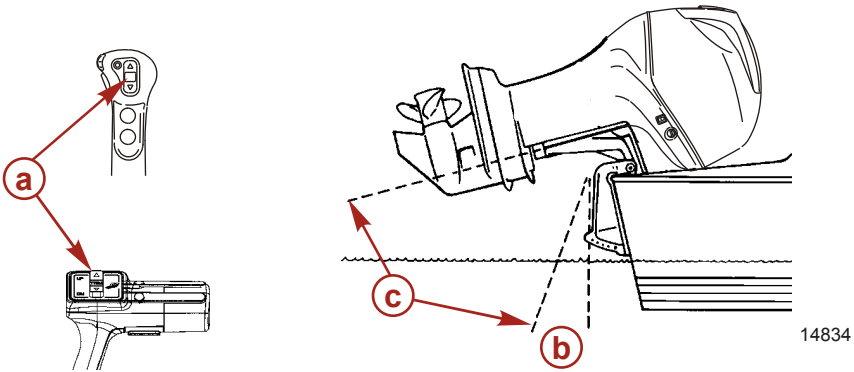

- a** - Trim switch
- b** - Trim range
- c** - Tilt range

## POWER TRIM OPERATION

With most boats, operating around the middle of the trim range will give satisfactory results. However, to take full advantage of the trimming capability there may be times when you choose to trim your outboard all the way in or out. Along with an improvement in some performance aspects comes a greater responsibility for the operator, and this is being aware of some potential control hazards.

## FEATURES AND CONTROLS

The most significant control hazard is a pull or torque that can be felt on the steering wheel or tiller handle. This steering torque results from the outboard being trimmed so the propeller shaft is not parallel to the water surface.

### WARNING

**Trimming the outboard beyond a neutral steering condition may result in a pull on the steering wheel or tiller handle and loss of boat control. Maintain control of the boat if trimming beyond a neutral steering condition.**

Consider the following lists carefully.

#### 1. Trimming in or down can:

- Lower the bow.
- Result in quicker planing off, especially with a heavy load or a stern heavy boat.
- Generally improve the ride in choppy water.
- Increase steering torque or pull to the right (with the normal right-hand rotation propeller).
- In excess, can lower the bow of some boats to a point where they begin to plow with their bow in the water while on plane. This can result in an unexpected turn in either direction (called bow steering or oversteering) if any turn is attempted, or if a significant wave is encountered.

### WARNING

**Operating the boat at high speeds with the outboard trimmed too far under can create excessive bow steer, resulting in the operator losing control of the boat. Install the trim limit pin in a position that prevents excessive trim under and operate the boat in a safe manner.**

- In rare circumstances, the owner may decide to limit the trim in. This can be accomplished by purchasing a stainless steel tilt pin from your dealer and inserting it in whatever adjustment hole in the transom brackets is desired. The nonstainless steel shipping bolt should not be used in this application other than on a temporary basis.

# FEATURES AND CONTROLS

## 2. Trimming out or up can:

- Lift the bow higher out of the water.
- Generally increase top speed.
- Increase clearance over submerged objects or a shallow bottom.
- Increase steering torque or pull to the left at a normal installation height (with the normal right hand rotation propeller).
- In excess, can cause boat porpoising (bouncing) or propeller ventilation.
- Cause engine overheating if any cooling water intake holes are above the waterline.

## TRIM WITHOUT KEY

Trim without key is a method of allowing trim operation after the ignition key switch is turned off. The command module and PCM remain powered and are able to process trim requests for up to 15 minutes after the key switch is turned off. The command module does not process any requests other than trim during this period. Once the 15 minute period expires, the command module sends a command through the CAN lines to shut down the PCM. On multi-engine applications, the timeout is managed separately for each engine.

The trim without key period may be ended at any time by moving the control handle to Wide-Open Throttle Reverse (WOTR) with the key off. To end the 15 minute period for the center engine in a shadow mode application, ensure all ignition key switches are in the "OFF" position and both remote control handles are in the Wide-Open Throttle Reverse (WOTR) position.

## TILTING TO FULL UP POSITION

### Tilt at Helm

**NOTE:** *The trim/tilt switch will remain active for 15 minutes after the ignition key switch has been turned off.*

1. If the ignition key switch has been turned off for over 15 minutes, turn it to the "ON" position.



# FEATURES AND CONTROLS

2. Press the trim/tilt switch to the up position. The outboard will tilt up until the switch is released or it reaches its maximum tilt position.

## Tilt at Engine

The cowl mounted auxiliary tilt switch can be used to tilt the outboard with the key switch in the "OFF" position.

## Tilt Support Lever

1. Engage the tilt support lever, by rotating knob to bring the support lever upward.
2. Lower outboard to rest on the tilt support lever.
3. Disengage the tilt support lever, by raising the outboard off the support lever and rotating the tilt support lever down. Lower the outboard.

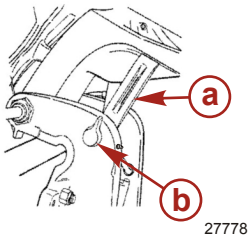

- a** - Tilt support lever  
**b** - Knob

## MANUAL TILTING

If the outboard cannot be tilted using the power trim/tilt switch, the outboard can be manually tilted.

**NOTE:** *The manual tilt release valve must be tightened before operating the outboard to prevent the outboard from tilting up during reverse operation.*

# FEATURES AND CONTROLS

Turn out the manual tilt release valve three turns counterclockwise. This allows manual tilting of the outboard. Tilt the outboard to the desired position and tighten the manual tilt release valve.

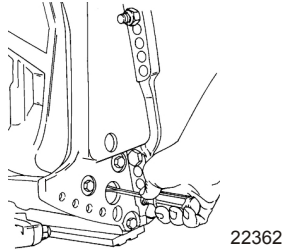

## AUXILIARY TILT SWITCH

**NOTE:** This model allows the auxiliary tilt switch to be mounted on either the port side (shown) or on the starboard side.

This switch can be used to tilt the outboard up or down using the power trim system.

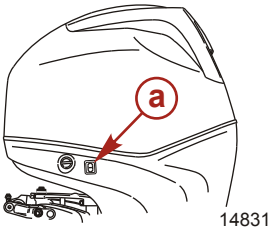

**a** - Auxiliary tilt switch (port side)

## SHALLOW WATER OPERATION

When operating your boat in shallow water, you can tilt the outboard beyond the maximum trim range to prevent hitting bottom.

1. Reduce engine speed below 2000 RPM.
2. Tilt outboard up. Make sure all the water intake holes stay submerged at all times.
3. Operate the engine at slow speed only. If engine speed exceeds 2000 RPM, the outboard will automatically return down to the maximum trim range.

# OPERATION

## Pre-Starting Check List

- Operator knows safe navigation, boating, and operating procedures.
- An approved personal flotation device of suitable size for each person aboard and readily accessible (it is the law).
- A ring type life buoy or buoyant cushion designed to be thrown to a person in the water.
- Know your boats' maximum load capacity. Look at the boat capacity plate.
- Fuel supply OK.
- Arrange passengers and load in the boat so the weight is distributed evenly and everyone is seated in a proper seat.
- Tell someone where you are going and when you expect to return.
- It is illegal to operate a boat while under the influence of alcohol or drugs.
- Know the waters and area you will be boating; tides, currents, sand bars, rocks, and other hazards.
- Make inspection checks listed in **Maintenance - Inspection and Maintenance Schedule**.

## Operating in Freezing Temperatures

When using your outboard or having your outboard moored in freezing or near freezing temperatures, keep the outboard tilted down at all times so the gearcase is submerged. This prevents trapped water in gearcase from freezing and causing possible damage to the water pump and other components.

If there is a chance of ice forming on the water, the outboard should be removed and drained completely of water. If ice should form at the water level inside the outboard driveshaft housing, it will block water flow to the engine causing possible damage.

## Operating in Saltwater or Polluted Water

We recommend that you flush the internal water passages of your outboard with fresh water after each use in salt or polluted water. This will prevent a buildup of deposits from clogging the water passages. Refer to **Maintenance - Flushing the Cooling System**.

# OPERATION

If you keep your boat moored in the water, always tilt the outboard so the gearcase is completely out of water (except in freezing temperatures) when not in use.

Wash the outboard exterior and flush out the exhaust outlet of the propeller and gearcase with fresh water after each use. Each month, spray Mercury Precision or Quicksilver Corrosion Guard on external metal surfaces. Do not spray on corrosion control anodes as this will reduce the effectiveness of the anodes.

## Setting Trim Angle While Running Engine at Idle Speed

The exhaust relief hole on the outboard can become submerged on some boats if the engine is trimmed full in while running at idle speed. This may result in exhaust restriction, rough idle, excessive smoke, and fouled spark plugs. If this condition exists, trim outboard up until exhaust relief hole is out of the water.

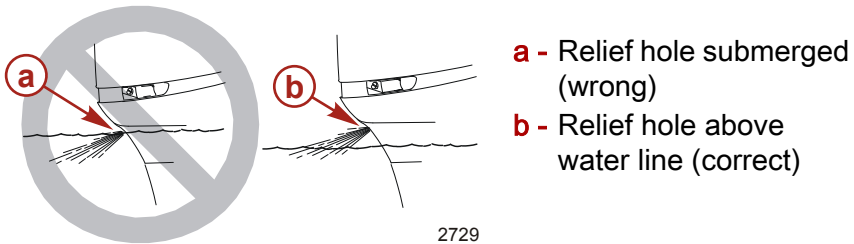

## Engine Break-in Procedure

**IMPORTANT:** Failure to follow the engine break-in procedures can result in poor performance throughout the life of the engine and can cause engine damage. Always follow break-in procedures.

1. For the first two hours of operation, run the engine at varied throttle settings up to 4500 RPM or at three-quarter throttle, and at full throttle for approximately one minute every ten minutes.
2. For the next eight hours of operation, avoid continuous operation at full throttle for more than five minutes at a time.

# OPERATION

## Starting the Engine

Before starting, read the **Pre-Starting Check List**, special operating instructions, **Engine Break-in Procedure**, and **Gear Shifting** in the **Operation** section and the remote control features and operation in the **Features and Controls** section.

### NOTICE

Without sufficient cooling water, the engine, the water pump, and other components will overheat and suffer damage. Provide a sufficient supply of water to the water inlets during operation.

1. Make sure the cooling water intake is submerged.

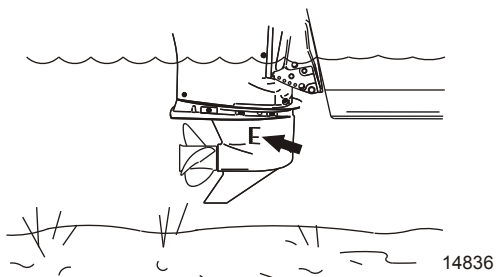

2. Check the engine oil level.

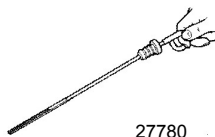

3. Open fuel tank vent on manual venting type tanks.

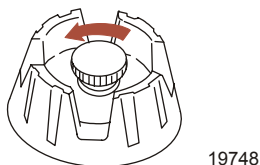

**NOTE:** The engine will not start unless the lanyard is set to the "RUN" position.

## OPERATION

4. Set the lanyard stop switch to the "RUN" position. Refer to **General Information - Lanyard Stop Switch**.



19791

5. Shift outboard to neutral (N) position.

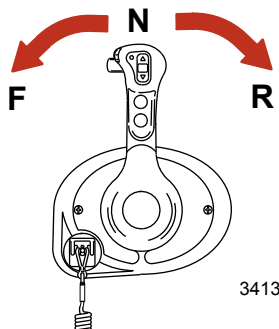

3413

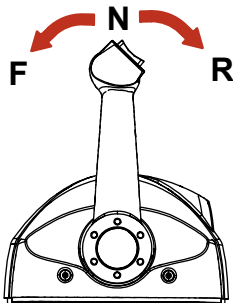

3417

**NOTE:** For initial start of a new engine or for an engine that ran out of fuel or was drained of fuel, the fuel system should be filled as follows:

Turn the ignition key switch to the "ON" position for approximately one minute. This operates the fuel lift pump. Turn the ignition key switch back to the "OFF" position and then return the ignition key switch to the "ON" position again for an additional minute. Turn the ignition key switch back to the "OFF" position. The filling of the fuel system is complete.

## OPERATION

6. Ignition key starting - Turn the ignition key to "START" position and release the key. The electronic starting system will automatically crank the engine for starting. If the engine fails to start, the engine will stop cranking. Turn the key to "START" position again until engine starts.

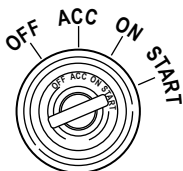

3485

7. After engine starts, check for a steady stream of water flowing out of the water pump indicator hole.

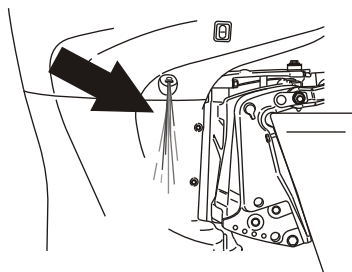

15301

**IMPORTANT:** If no water is coming out of the water pump indicator hole, stop engine and check the cooling water intake for obstruction. No obstruction may indicate a water pump failure or blockage in the cooling system. These conditions will cause the engine to overheat. Have the outboard checked by your dealer. Operating the engine while overheated will cause engine damage.

### Gear Shifting

#### DTS PANEL MOUNT REMOTE CONTROL

**IMPORTANT:** Never shift outboard into gear unless engine speed is at idle. Do not shift outboard into forward or reverse when the engine is not running.

## OPERATION

- The outboard has three gear shift positions to provide operation: Forward (F), Neutral (N), and Reverse (R).

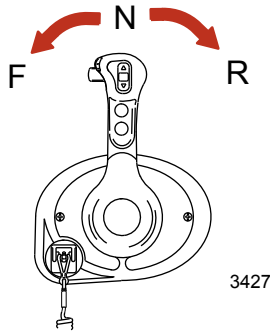

- When shifting, always stop at neutral position and allow the engine speed to return to idle.
- Panel mount remote control requires the operator to always press shift lock while moving the control handle out of the neutral position.

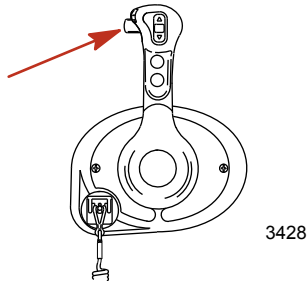

- Advance the control lever to further increase speed.

### DTS CONSOLE MOUNT REMOTE CONTROL

**IMPORTANT:** Never shift outboard into gear unless engine speed is at idle. Do not shift outboard into forward or reverse when the engine is not running.



## OPERATION

- The outboard has three gear shift positions to provide operation: Forward (F), Neutral (N), and Reverse (R).

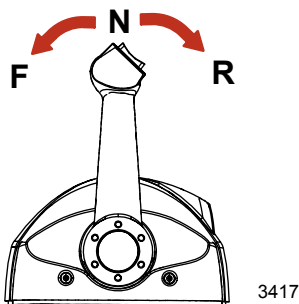

- When shifting, always stop at neutral position and allow the engine speed to return to idle.
- Advance the control lever to further increase speed.

### Stopping the Engine

**IMPORTANT:** Turning key to the "START" position while the engine is running will result in engine shut down, while leaving the DTS system active. This will allow the use of the power trim/tilt from the remote control handle.

Reduce engine speed and shift outboard to neutral position. Turn ignition key to "OFF" position.

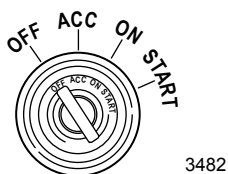

# MAINTENANCE

## Outboard Care

To keep your outboard in the best operating condition, it is important that your outboard receive the periodic inspections and maintenance listed in the **Inspection and Maintenance Schedule**. We urge you to keep it maintained properly to ensure the safety of you and your passengers, and retain its dependability. Record maintenance performed in the **Maintenance Log** at the back of this book. Save all maintenance work orders and receipts.

## SELECTING REPLACEMENT PARTS FOR YOUR OUTBOARD

We recommend using original Mercury Precision or Quicksilver replacement parts and Genuine Lubricants.

## EPA Emissions

### EMISSION CERTIFICATION LABEL

An emission certification label, showing emission levels and engine specifications directly related to emissions, is placed on the engine at time of manufacture.

<b>MERCURY</b>		<b>EMISSION CONTROL INFORMATION</b>	
THIS ENGINE CONFORMS TO <input type="checkbox"/> CALIFORNIA AND U.S. EPA EMISSION REGULATIONS FOR SPARK IGNITION MARINE ENGINES			
REFER TO OWNERS MANUAL FOR REQUIRED MAINTENANCE, SPECIFICATIONS, AND ADJUSTMENTS			
IDLE SPEED (in gear): <input type="text"/>		FAMILY: <input type="text"/>	
<input type="text"/> hp	<input type="text"/> cc	FEL: <input type="text"/>	<input type="text"/> g/kWh
TIMING (IN DEGREES): <input type="text"/>			
COLD VALVE CLEARANCE (mm): <input type="text"/>		SPARK PLUG GAP: <input type="text"/>	
INTAKE: <input type="text"/>		EXHAUST: <input type="text"/>	

21096

- a - Idle speed
- b - Engine horsepower
- c - Piston displacement
- d - Part number
- e - Valve clearance (if applicable)
- f - Family number
- g - Maximum emission output for the engine family
- h - Timing specification
- i - Recommended spark plug and gap

# MAINTENANCE

## OWNER RESPONSIBILITY

The owner/operator is required to have routine engine maintenance performed to maintain emission levels within prescribed certification standards.

The owner/operator is not to modify the engine in any manner that would alter the horsepower or allow emissions levels to exceed their predetermined factory specifications.

## Inspection and Maintenance Schedule

### BEFORE EACH USE

- Check engine oil level. See **Fuel and Oil - Checking and Adding Engine Oil**.
- Check that lanyard stop switch stops the engine.
- Inspect the outboard for tightness to the boat transom. If any looseness of the outboard or mounting fasteners exist, retorque the outboard mounting fasteners to 75 Nm (55 lb-ft).
- Visually inspect the fuel system for deterioration or leaks.
- Check outboard for tightness on transom.
- Check steering system for binding or loose components.
- Visually check hydraulic steering fittings and hoses for leaks or signs of damage. Check tie bar fasteners (multiple outboard rigs) for proper tightness.
- Check propeller blades for damage.

### AFTER EACH USE

- Flush out the outboard cooling system if operating in salt or polluted water. See **Flushing the Cooling System**.
- Wash off all salt deposits and flush out the exhaust outlet of the propeller and gearcase with fresh water if operating in saltwater.

### EVERY 100 HOURS OF USE OR ONCE YEARLY, WHICHEVER OCCURS FIRST

- Retorque the outboard mounting fasteners that fasten the outboard to the boat transom. Torque to 75 Nm (55 lb-ft).<sup>1</sup>

1. These items should be serviced by an authorized dealer.

# MAINTENANCE

- Change engine oil and replace the oil filter. The oil should be changed more often when the engine is operated under adverse conditions such as extended trolling. See **Changing Engine Oil**.
- Inspect thermostat visually for corrosion or for a broken spring. Make sure thermostat closes completely at room temperature.  
1.
- Check engine water separating fuel filter for contaminants. Clean and/or replace filter. See **Fuel System**.
- Check corrosion control anodes. Check more frequently when used in saltwater. See **Corrosion Control Anode**.
- Drain and replace gearcase lubricant. See **Gearcase Lubrication**.
- Check power trim fluid. See **Checking Power Trim Fluid**.
- Check power steering fluid (if so equipped). See **Checking Power Steering Fluid**.
- Inspect battery. See **Battery Inspection**.
- Saltwater usage. Remove and inspect spark plugs for corrosion and replace spark plugs as necessary. Apply a thin coating of Anti-Seize Compound only on threads of spark plug prior to installation. See **Spark Plug Inspection and Replacement**.
- Check cowl seals to make sure seals are intact and not damaged.
- Check internal cowl sound reduction foam (if equipped) to make sure foam is intact and not damaged.
- Check that the intake silencer (if equipped) is in place.
- Check that the idle relief muffler (if equipped) is in place.
- Check for loose hose clamps and rubber boots (if equipped) on the air intake assembly.

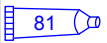
Tube Ref No.	Description	Where Used	Part No.
 81	Anti-Seize Compound	Spark plug threads	92-881091K 1

- Check wiring and connectors.

# MAINTENANCE

- Check tightness of bolts, nuts, and other fasteners.

## EVERY 300 HOURS OF USE OR THREE YEARS

**IMPORTANT:** Engine oil must be drained before removing gearcase to avoid oil spillage. Perform scheduled water pump replacement in combination with an engine oil change.

- Replace water pump impeller (more often if overheating occurs or reduced water pressure is noted).<sup>1</sup>
- Replace high-pressure in-line fuel filter.<sup>1</sup>
- Replace spark plugs at first 300 hours or three years. After that, inspect spark plugs every 300 hours or three years. Replace spark plugs as needed. See **Spark Plug Inspection and Replacement**.
- Replace accessory drive belt. See **Accessory Drive Belt Inspection**.<sup>1</sup>

## BEFORE PERIODS OF STORAGE

- Refer to storage procedure. See **Storage** section.

## Flushing the Cooling System

Flush the internal water passages of the outboard with fresh water after each use in salt, polluted, or muddy water. This will help prevent a buildup of deposits from clogging the internal water passages.

**NOTE:** *The outboard can be tilted or in the vertical operating position during flushing.*

1. With the engine turned off, place the outboard in either the operating position (vertical) or in a tilted position.
2. Remove the flush connector from the bottom cowl.

## MAINTENANCE

3. Remove the cover from the flush connector and thread a water hose into the flush connector.

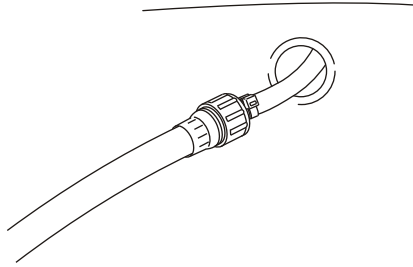

14810

4. Turn on the water tap (1/2 maximum) and let the water flush through the cooling system for about 15 minutes.
5. When flushing is complete, turn off water and disconnect the water hose.
6. Reinstall the cover on the flush connector. Place the flush connector back into the bottom cowl.

## Top Cowl Removal and Installation

### REMOVAL

Unlock the top cowl by pulling out on the rear cowl latch. Lift the top cowl off the engine.



29767

# MAINTENANCE

## INSTALLATION

Bring the front of the cowl down first and engage the front hook. Lower the cowl into its seated position and apply downward pressure to the back of the cowl to lock it in place. Ensure that the cowl is securely fastened by trying to pull up on the back of the cowl.



## Cleaning Care for Top and Bottom Cowls

**IMPORTANT:** Dry wiping (wiping the plastic surface when it is dry) will result in minor surface scratches. Always wet the surface before cleaning. Do not use detergents containing hydrochloric acid. Follow the cleaning and waxing procedure.

### CLEANING AND WAXING PROCEDURE

1. Before washing, rinse the cowls with clean water to remove dirt and dust that may scratch the surface.
2. Wash the cowls with clean water and a mild nonabrasive soap. Use a soft clean cloth when washing.
3. Dry thoroughly with a soft clean cloth.
4. Wax the surface using a nonabrasive automotive polish (polish designed for clear coat finishes). Remove the applied wax by hand using a clean soft cloth.
5. To remove minor scratches, use Mercury Marine Cowl Finishing Compound (92-859026K 1).

# MAINTENANCE

## Cleaning Care for the Powerhead (Saltwater Use)

If the outboard is operated in saltwater, remove the top cowl and flywheel cover. Inspect the powerhead and powerhead components for salt build-up. Wash off any salt build-up from the powerhead and powerhead components with fresh water. Keep water spray out of the air filter/intake and alternator. After washing, allow the powerhead and components to dry. Apply Quicksilver or Mercury Precision Lubricants Corrosion Guard spray on the external metal surfaces of the powerhead and powerhead components. Do not allow the Corrosion Guard spray to come in contact with the alternator drive belt or belt pulleys.

**IMPORTANT: Do not allow lubricant or Corrosion Guard spray to come in contact with the alternator drive belt or the belt pulleys. The alternator drive belt could slip and be damaged if it becomes coated with any lubricant or Corrosion Guard spray.**

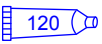
Tube Ref No.	Description	Where Used	Part No.
 120	Corrosion Guard	External metal surfaces of the powerhead and powerhead components.	92-802878 55

## Battery Inspection

The battery should be inspected at periodic intervals to ensure proper engine starting capability.

**IMPORTANT: Read the safety and maintenance instructions which accompany your battery.**

1. Turn off the engine before servicing the battery.
2. Make sure the battery is secure against movement.
3. Battery cable terminals should be clean, tight, and correctly installed. Positive to positive and negative to negative.
4. Make sure the battery is equipped with a nonconductive shield to prevent accidental shorting of battery terminals.

## Verado Engine Battery Specifications

**IMPORTANT: Verado engines require a 12 volt AGM (absorbed glass mat) marine starting battery that meets the minimum ratings.**



# MAINTENANCE

For best performance, Mercury Marine does not recommend using the more common flooded (wet cell) or gel cell type lead acid batteries for starting Verado engines.

Each Verado engine must be equipped with its own starting battery.

If the boat application requires additional battery loads for boat accessories or marine electronics, it is recommended that an auxiliary battery, or batteries, be installed.

Choose a 12 volt AGM (absorbed glass mat) battery which meets the following ratings.

USA (SAE) Verado Starting Battery Rating	
Required Verado starting battery	12 volt AGM (absorbed glass mat) battery
Required MCA (marine cranking amps) and reserve capacity	800 minimum marine cranking amps with a minimum reserve capacity of 135 minutes RC25 rating

International (EN) Verado Starting Battery Rating	
Required Verado starting battery	12 volt AGM (absorbed glass mat) battery
Required CCA (cold cranking amps) and Ah (amp hour)	1000 minimum cold cranking amps with a minimum of 180 amp hours

**NOTE:** Do not use an engine starting battery that does not meet the specified ratings. If a battery that does not meet the ratings is used, the electrical system may perform poorly.

**IMPORTANT:** Boating industry standards (BIA, ABYC, etc.), federal standards, and Coast Guard regulations must be adhered to when installing the battery. Ensure that battery cable installation meets the pull test requirements and that the positive battery terminal is properly insulated in accordance with regulations. It is recommended (required in some states) that the battery be installed in an enclosed case. Refer to regulations for your area.

When connecting the engine battery, hex nuts must be used to secure the battery leads to the battery posts. Tighten the hex nuts to the specified torque.

# MAINTENANCE

## ⚠ WARNING

Failure to properly secure the battery leads can result in a loss of power to the Digital Throttle and Shift (DTS) system, leading to serious injury or death due to loss of boat control. Secure the battery leads to the battery posts with hex nuts to avoid loose connections.

Description	Nm	lb. in.	lb. ft.
Hex nuts	13.5	120	

**IMPORTANT:** Battery cable size and length is critical. Refer to Battery Cable Size tables or engine installation manual for size requirements.

The decal needs to be placed on or near the battery box for future service reference. One 5/16 in. and one 3/8 in. hex nut is supplied per battery for wing nut replacement. Metric hex nuts are not supplied.

**NOTICE - Verado Engines**

**USE ONLY AGM BATTERIES!**

Verado engines must use an AGM marine battery that meets minimum ratings listed below.

<table style="width: 100%; border-collapse: collapse;"> <tr><td style="border: 1px solid black; padding: 2px;">USA (SAE)</td></tr> <tr><td style="border: 1px solid black; padding: 2px;">800 MCA</td></tr> <tr><td style="border: 1px solid black; padding: 2px;">135 min RC25</td></tr> </table>	USA (SAE)	800 MCA	135 min RC25	<table style="width: 100%; border-collapse: collapse;"> <tr><td style="border: 1px solid black; padding: 2px;">International (EN)</td></tr> <tr><td style="border: 1px solid black; padding: 2px;">1000 CCA</td></tr> <tr><td style="border: 1px solid black; padding: 2px;">180 Ah</td></tr> </table>	International (EN)	1000 CCA	180 Ah
USA (SAE)							
800 MCA							
135 min RC25							
International (EN)							
1000 CCA							
180 Ah							

13.5Nm  
(120 lbs. in.)

**DO NOT USE WING NUTS.**

**IMPORTANT:**  
Battery cable size and length is critical. Refer to engine installation manual for size requirements.

Place decal on or near battery box for future service reference. 5/16" and 3/8" hex nuts supplied for wing nut replacement. Metric hex nuts not supplied.

33871

## Air Filter

The air filter is located within the flywheel cover assembly. The air filter removes airborne particles which may damage engine components. The air filter design allows for maximum unrestricted air flow during engine operation.

# MAINTENANCE

## AIR FILTER REMOVAL

1. Remove the FSM vent hose and the engine ventilation hose from the flywheel cover.
2. Remove the bolts securing the flywheel cover to the rear mounting posts.

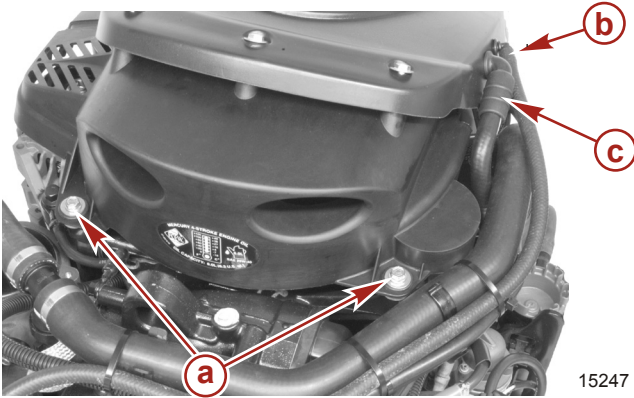

- a** - Flywheel cover bolt and washer (2)
- b** - FSM vent hose
- c** - Engine ventilation hose

3. Lift the flywheel cover off the front mounting post and the intake resonator.
4. Remove three screws holding the upper flywheel cover to the lower flywheel cover.



# MAINTENANCE

5. Separate the two flywheel cover subassemblies to access the air filter.
6. Remove the air filter from the lower flywheel cover assembly.

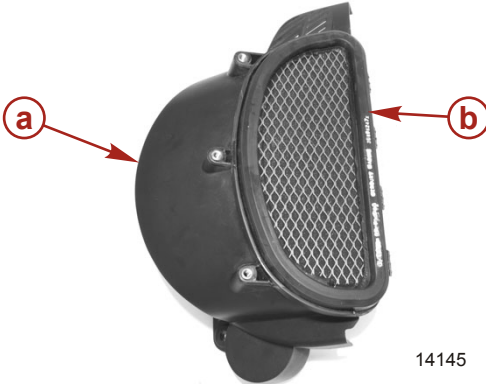

- a** - Flywheel cover subassembly
- b** - Air filter

## AIR FILTER INSTALLATION

1. Install the air filter onto the flywheel cover subassembly.

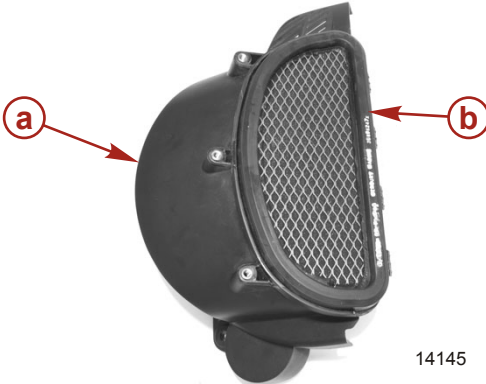

- a** - Flywheel cover subassembly
- b** - Air filter

# MAINTENANCE

2. Install the upper half of the flywheel cover subassembly to the lower flywheel cover subassembly. Ensure the upper flywheel cover latch opening is properly secured to the lower flywheel cover.

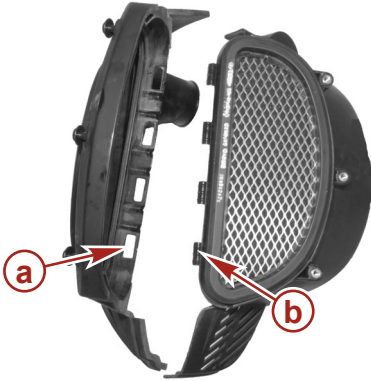

- a** - Upper flywheel cover latch opening
- b** - Lower flywheel cover latch

14314

3. Push the two subassemblies together and install three screws. Tighten the three screws to the specified torque.

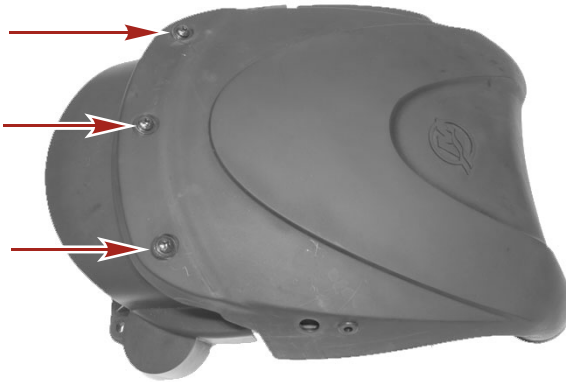

14309

Description	Nm	lb-in.	lb-ft
Screw	6	53	

4. Install the flywheel cover onto the resonator and the front mounting post.
5. Align the flywheel cover rear bolt holes with the rear mounting posts.

# MAINTENANCE

- Secure the flywheel cover to the rear mounting posts with two bolts with washers. Tighten bolts to the specified torque.

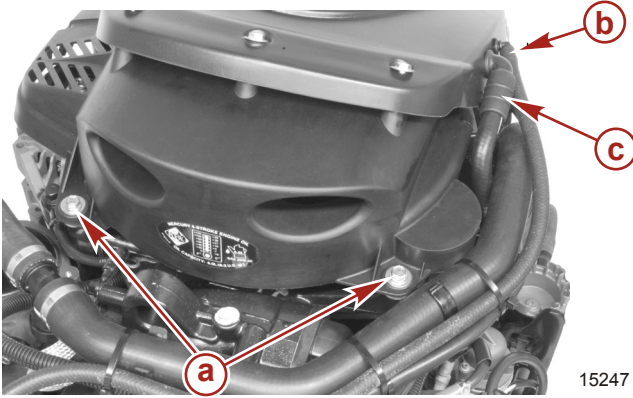

- a** - Flywheel cover bolt and washer (2)
- b** - FSM vent hose
- c** - Engine ventilation hose

Description	Nm	lb-in.	lb-ft
Flywheel cover bolt	10	88.5	

## Fuel System

### **⚠ WARNING**

Fuel is flammable and explosive. Ensure the key switch is off and the lanyard is positioned so that the engine cannot start. Do not smoke or allow sources of spark or open flame in the area while servicing. Keep the work area well ventilated and avoid prolonged exposure to vapors. Always check for leaks before attempting to start the engine and wipe up any spilled fuel immediately.

**IMPORTANT:** Use an approved container to collect and store fuel. Wipe up spilled fuel immediately. Material used to contain spilled fuel must be disposed of in an approved receptacle.

Before servicing any part of the fuel system:

- Stop engine and disconnect the battery.

# MAINTENANCE

2. Perform fuel system service in a well-ventilated area.
3. Inspect any completed service work for sign of fuel leakage.

## FUEL LINE INSPECTION

Visually inspect the fuel line for cracks, swelling, leaks, hardness, or other signs of deterioration or damage. If any of these conditions are found, the fuel line must be replaced.

## WATER SEPARATING FUEL FILTER

**NOTE:** *The warning system will turn on when water in the fuel filter reaches the full level.*

This filter removes moisture and debris from the fuel. If the filter holder becomes filled with water, the water can be removed. If the filter becomes plugged with debris, replace the filter.

Refer to the **Inspection and Maintenance Schedule** for the proper maintenance interval.

### Filter Removal

1. Turn ignition key switch to "OFF" position.
2. Remove fuel vapor purge relief valve cap located at the rear of the engine.

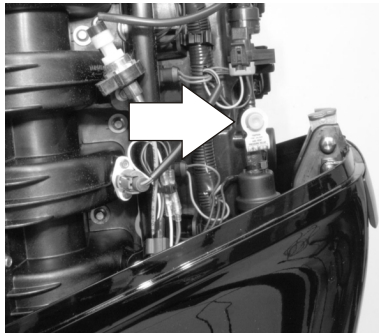

14765

## **⚠ CAUTION**

Failure to release pressure from the fuel system will result in fuel spraying out, which can cause a fire or explosion. Allow the engine to cool completely and release all fuel pressure before servicing any part of the fuel system. Always protect eyes and skin from pressurized fuel and vapors.

# MAINTENANCE

3. Place a rag or towel around the valve, release pressure by pushing core of valve end in.

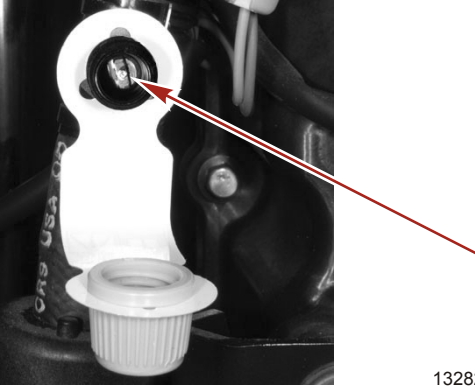

13282

4. Unscrew the filter in a counterclockwise direction to remove.

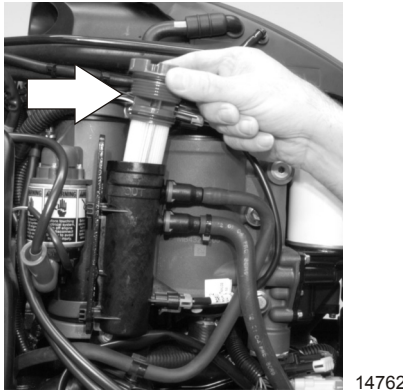

14762

## Filter Draining

1. Slide filter holder up to release from bracket. Hoses and wire harness can remain attached to filter holder.



# MAINTENANCE

2. Tip the filter holder to drain any fluid into an approved container.

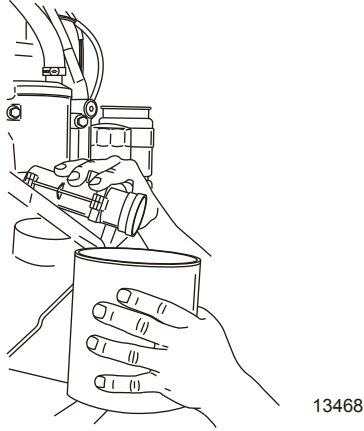

## Filter Installation

1. Position filter holder onto bracket and secure filter holder in place.
2. Lubricate the sealing ring on the filter with oil.
3. Install the filter and tighten securely by hand.

**IMPORTANT:** Visually inspect for fuel leakage from the filter while turning the ignition key to the "RUN" position, forcing fuel into the filter.



# MAINTENANCE

## Corrosion Control Anode

The outboard has corrosion control anodes at different locations. An anode helps protect the outboard against galvanic corrosion by sacrificing its metal to be slowly eroded instead of the outboard metals.

Each anode requires periodic inspection, especially in saltwater which will accelerate the erosion. To maintain this corrosion protection, always replace the anode before it is completely eroded. Never paint or apply a protective coating on the anode as this will reduce effectiveness of the anode.

Two anodes are located on each side of the gearcase. Another anode is installed on the bottom of the transom bracket assembly.

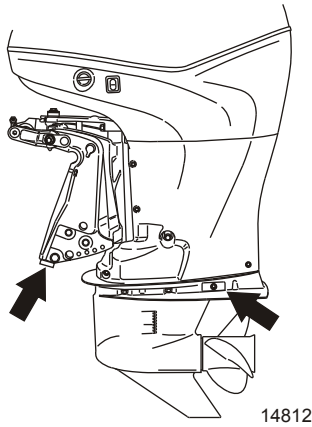

## Propeller Replacement

1. Shift outboard to neutral position.
2. Straighten the bent tabs on the propeller nut retainer.

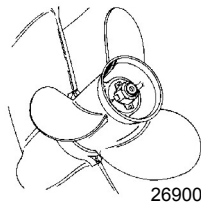

# MAINTENANCE

- Place a block of wood between gearcase and propeller to hold propeller and remove propeller nut.

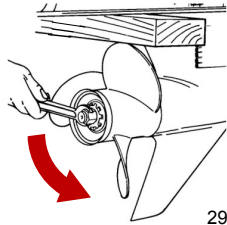

29592

- Pull propeller straight off shaft. If propeller is seized to the shaft and cannot be removed, have the propeller removed by an authorized dealer.
- To aid in future removal of the propeller, liberally coat the propeller shaft splines with one of the following Mercury/Quicksilver products:

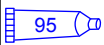
Tube Ref No.	Description	Where Used	Part No.
 94	Anti-Corrosion Grease	Propeller shaft splines	92-802867Q 1
 95	2-4-C with Teflon	Propeller shaft splines	92-802859A 1

- Flo-Torq II drive hub propellers** - Install forward thrust hub, replaceable drive sleeve, propeller, thrust hub, propeller nut retainer, and propeller nut onto the shaft.

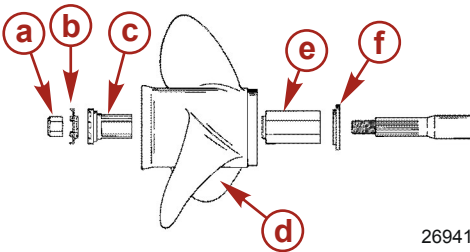

26941

- a** - Propeller nut
- b** - Propeller nut retainer
- c** - Thrust hub
- d** - Propeller
- e** - Replaceable drive sleeve
- f** - Forward thrust hub

# MAINTENANCE

7. **Flo-Torq IV drive hub propellers** - Install forward thrust hub, replaceable drive sleeve, propeller, thrust hub, propeller nut retainer, and propeller nut onto the shaft.

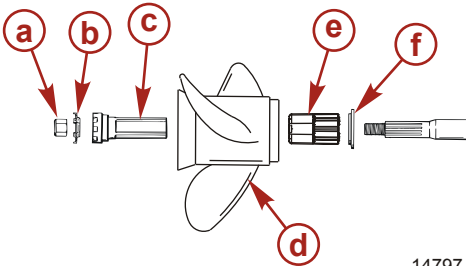

14797

- a** - Propeller nut
- b** - Propeller nut retainer
- c** - Thrust hub
- d** - Propeller
- e** - Replaceable drive sleeve
- f** - Forward thrust hub

8. Place a block of wood between gearcase and propeller and torque to specifications.

Description	Nm	lb-in.	lb-ft
Propeller nut	75		55

9. Secure propeller nut by bending three of the tabs into the thrust hub grooves.

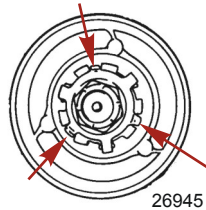

26945

## Spark Plug Inspection and Replacement

**NOTE:** To gain access to the bottom spark plug, remove the rear cover and rear cowl lock.

### COWL LOCK AND REAR COVER REMOVAL

1. Remove the pivot screw and flat washer from the rear cowl latch.

# MAINTENANCE

2. Pull out on the rear corner of the latch to clear the rear cover. Remove the rear cowl latch.

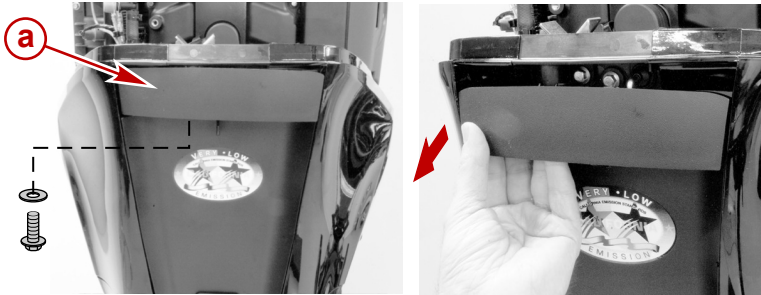

29740

**a** - Rear cowl latch

3. Remove the two screws securing the rear cover. Locate the two arrows (pry points) on the rear cover. Use a thin blade screwdriver at these pry points and pry out the cover. Remove the rear cover.
4. Remove the six screws securing the cowl lock and remove the lock. Retain the two hex nuts that are used to fasten the top two screws.

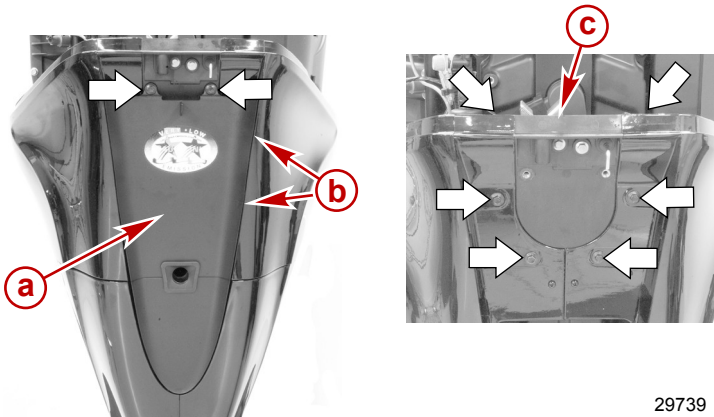

29739

- a** - Rear cover  
**b** - Pry point (arrow)  
**c** - Cowl lock

# MAINTENANCE

## SPARK PLUG REMOVAL AND INSPECTION

1. Disconnect the wiring harness connectors from the pencil coils.
2. Remove the mounting bolts that are securing the pencil coils. Pull the pencil coils from the spark plugs using a twisting motion.

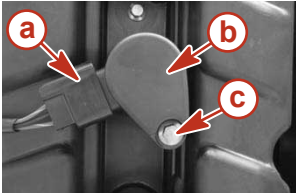

3658

- a - Wiring harness connector
- b - Pencil coil
- c - Bolt

3. Remove the spark plugs to inspect. Replace spark plug if electrode is worn, threads of seal area are corroded, or the insulator is rough, cracked, broken, blistered, or fouled.

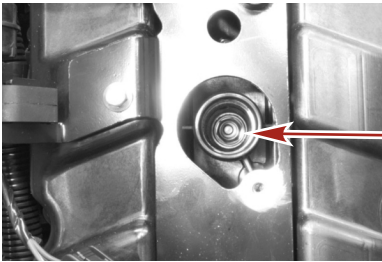

14794

4. Set the spark plug gap to specifications.

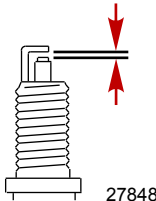

27848

Spark Plug	
Spark plug gap	0.8 mm (0.0315 in.)

5. Saltwater use - Apply a thin coating of Anti-Seize Compound only on threads of the spark plugs.

# MAINTENANCE

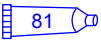
Tube Ref No.	Description	Where Used	Part No.
 81	Anti-Seize Compound	Spark plug threads	92-881091K 1

## SPARK PLUG INSTALLATION

1. Before installing the spark plugs, clean off any dirt on the spark plug seats. Install plugs finger-tight, and then tighten 1/4 turn or torque to specifications.

Description	Nm	lb. in.	lb. ft.
Spark plug	27		20

2. Push the pencil coils into place over the spark plugs using a twisting motion.
3. Secure the coils with retained bolts. Torque to specifications.

Description	Nm	lb. in.	lb. ft.
Bolts	8	71	

4. Reconnect the wiring harness connectors to the pencil coil connections.

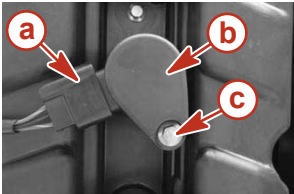

- a** - Wiring harness connector
- b** - Pencil coil
- c** - Bolt

5. Reinstall the cowl lock, rear cowl, and rear cowl latch. Torque to specifications.

Description	Nm	lb. in.	lb. ft.
Rear cowl latch - back screws (4)	15	53	
Rear cowl latch - top screws with hex nuts (2)	25	89	
Rear cover - screws (2)	15	53	
Pivot screw	15	53	

# MAINTENANCE

## Fuses

The electrical wiring circuits on the outboard are protected from overload by fuses in the wiring. If a fuse is blown, try to locate and correct the cause of the overload. If the cause is not found, the fuse may blow again.

Remove the fuse puller from the engine.



# MAINTENANCE

Remove the cover from the fuse holder. Remove the suspected blown fuse and look at the silver band inside the fuse. If the band is broken, replace the fuse. Replace the fuse with a new fuse with the same amp rating.

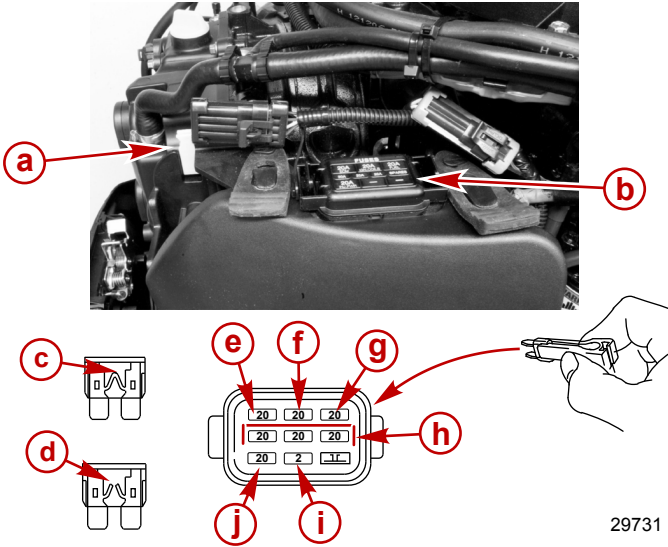

29731

- a** - Fuse puller
- b** - Fuse holder
- c** - Good fuse
- d** - Blown fuse
- e** - Electronic Control Module and purge valve "ECM" - 20 amp fuse
- f** - Ignition coils "IGN. COILS" - 20 amp fuse
- g** - Fuel delivery "FUEL" - 20 amp fuse
- h** - Spare fuses (3)
- i** - Diagnostics terminal - 2 amp fuse
- j** - Injector power and boost valve "INJ. PWR." - 20 amp fuse

# MAINTENANCE

## Steering Link Rod Fasteners

**IMPORTANT:** The steering link rod that connects the steering cable to the engine must be fastened using special washer head bolt ("a" - Part Number 10-849838) and self-locking nylon insert locknuts ("c" & "d" - Part Number 11-826709113). These locknuts must never be replaced with common nuts (non-locking) as they will work loose and vibrate off freeing the link rod to disengage.

### ⚠ WARNING

Improper fasteners or improper installation procedures can result in loosening or disengagement of the steering link rod. This can cause a sudden, unexpected loss of boat control, resulting in serious injury or death due to occupants being thrown within or out of the boat. Always use required components and follow instructions and torque procedures.

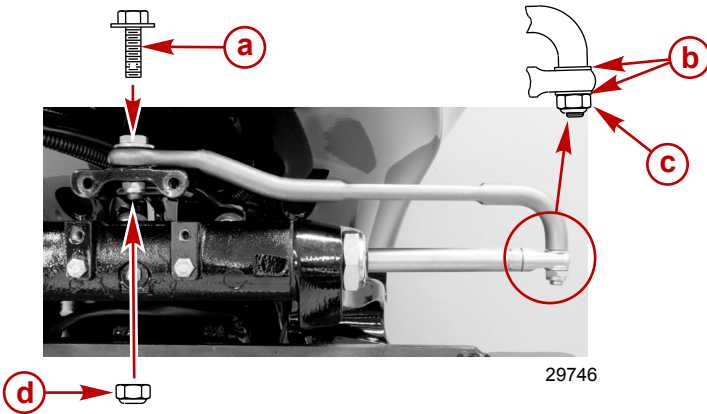

- a** - Special washer head bolt (10-849838)
- b** - Flat washer (2)
- c** - Nylon insert locknut (11-826709113)
- d** - Nylon insert locknut (11-826709113)

Description	Nm	lb. in.	lb. ft.
Special washer head bolt	27		20
Nylon insert locknut "d"	27		20

# MAINTENANCE

Description	Nm	lb. in.	lb. ft.
Nylon insert locknut "c"	Tighten until seats, then back off 1/4 turn		

Assemble the steering link rod to steering cable with two flat washers and self-locking nylon insert locknut. Tighten the locknut until it seats, then back nut off 1/4 turn.

Assemble the steering link rod to the engine with special washer head bolt and self-locking nylon insert locknut. First torque the bolt, then torque the locknut to specifications.

## DTS Wiring System

### WARNING

**Splicing or probing will damage the wire insulation allowing water to enter the wiring. Water intrusion may lead to wiring failure and loss of throttle and shift control. To avoid the possibility of serious injury or death from loss of boat control, do not splice or probe into any wire insulation of the DTS system.**

- Verify the harnesses are not routed near sharp edges, hot surfaces, or moving parts.
- Verify all unused connectors and receptacles are covered with a weather cap.
- Verify the harnesses are fastened along the routing path.

## Accessory Drive Belt Inspection

Inspect the accessory drive belt and have it replaced by an authorized dealer if any of the following conditions are found.

- Cracks in the back of the belt or in the base of V grooves.
- Excessive wear at the roots of the grooves.
- Rubber portion swollen by oil.
- Belt surfaces roughened.
- Signs of wear on edges or outer surfaces of belt.

## Lubrication Points

1. Lubricate the following with Quicksilver or Mercury Precision Special Lubricant 101.



# MAINTENANCE

Tube Ref No.	Description	Where Used	Part No.
 34	Special Lubricant 101	Trim rod ball ends	92-802865Q02

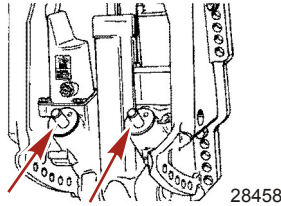
- Trim Rod Ball Ends - Turn the ball ends to work the lubricant into the ball sockets.



2. Lubricate the following with Quicksilver or Mercury Precision Lubricants Anti-Corrosion Grease or 2-4-C with Teflon.

Tube Ref No.	Description	Where Used	Part No.
 94	Anti-Corrosion Grease	Propeller shaft	92-802867Q 1
 95	2-4-C with Teflon	Propeller shaft	92-802859A 1

- Propeller Shaft - Refer to **Propeller Replacement** for removal and installation of the propeller. Coat the entire propeller shaft with lubricant to prevent the propeller hub from corroding and seizing to the shaft.

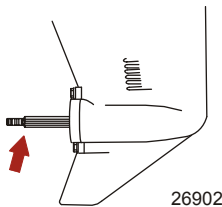

3. Lubricate the following with Quicksilver or Mercury Precision Lubricants 2-4-C with Teflon or Special Lubricant 101.

# MAINTENANCE

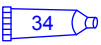
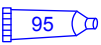
Tube Ref No.	Description	Where Used	Part No.
 34	Special Lubricant 101	Swivel bracket, tilt support lever, tilt tube	92-802865Q02
 95	2-4-C with Teflon	Swivel bracket, tilt support lever, tilt tube	92-802859A 1

- Swivel Bracket - Lubricate through fitting.
- Tilt Support Lever - Lubricate through fitting.

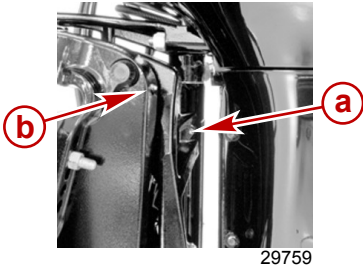

- a** - Swivel bracket
- b** - Tilt support lever

- Tilt Tube - Lubricate through fitting.

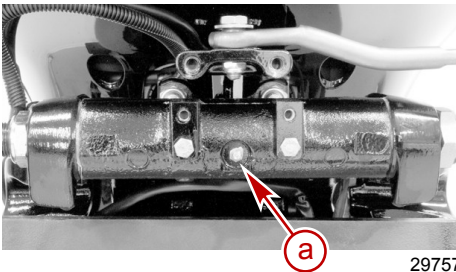

- a** - Tilt tube fitting

- Lubricate the following with Quicksilver or Mercury Precision Lubricants 2-4-C with Teflon or Special Lubricant 101.

# MAINTENANCE

## ⚠ WARNING

Incorrect cable lubrication can cause hydraulic lock, leading to serious injury or death from loss of boat control. Completely retract the end of the steering cable before applying lubricant.

Steering Cable - Rotate the steering wheel to fully retract the steering cable end into the outboard tilt tube. Lubricate through the fitting.

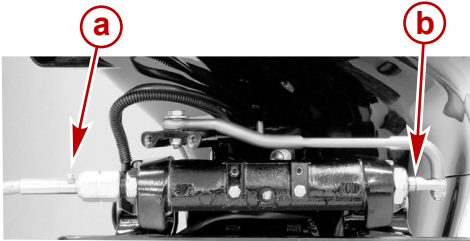

29763

- a - Fitting
- b - Cable end

- Lubricate the following with Light Weight Oil.
  - Steering Link Rod Pivot Points - Lubricate pivot points.

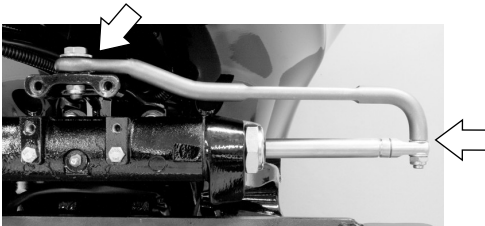

29765

# MAINTENANCE

## Checking Power Trim Fluid

1. Tilt outboard to the full up position and engage the tilt support lever.

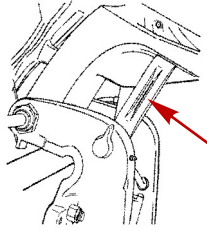

27877

2. Remove fill cap and check fluid level. The fluid level should be even with the bottom of the fill hole. Add Quicksilver or Mercury Precision Lubricant Power Trim and Steering Fluid. If not available, use automotive automatic transmission fluid (ATF).

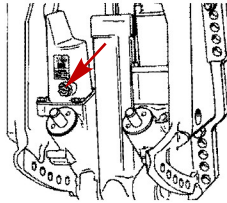

28460

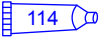
Tube Ref No.	Description	Where Used	Part No.
 114	Power Trim and Steering Fluid	Power trim system	92-858074K01

# MAINTENANCE

## Checking Power Steering Fluid

Remove power steering cover and fill cap to check fluid level. The fluid level should be slightly below the bottom of the fill hole. Use SAE 0W-30 synthetic power steering fluid, if needed.

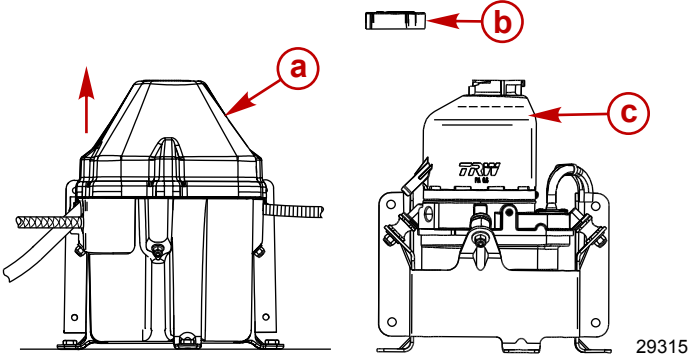

- a - Power steering cover
- b - Fill cap
- c - Fill/full level

Tube Ref No.	Description	Where Used	Part No.
 138	Synthetic Power Steering Fluid SAE 0W-30	Power steering system	92-858076K01

## Changing Engine Oil

### ENGINE OIL CAPACITY

Engine oil capacity is approximately 6.0 liter (6.3 US qt).

### PUMP METHOD

**IMPORTANT:** Tilt outboard out/up past vertical for approximately one minute to allow trapped oil to drain back to the oil sump.

**IMPORTANT:** To reduce or prevent oil spillage when removing the oil filter, ensure the outboard is upright (not tilted) and the engine is cold or has not run for at least one hour.

1. Tilt outboard out/up past vertical for approximately one minute to allow trapped oil to drain back to the oil sump.



# MAINTENANCE

2. Place the outboard in a vertical position.
3. Remove dipstick and slide adapter tube of crankcase oil pump through oil dipstick hole, to bottom of engine oil sump.

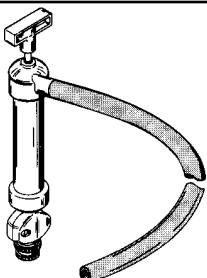
Crankcase Oil Pump	91-90265A 5
 <p>11591</p>	Aids in the removal of engine oil without draining the crankcase.

4. Pump out the engine oil into an appropriate container.

## DRAIN METHOD

1. Tilt outboard up to the trailer position.
2. Turn the outboard so the drain hole is facing downward.
3. Remove the drain plug/seal and drain the engine oil into an appropriate container.
4. Lubricate seal washer on the drain plug with oil and reinstall.

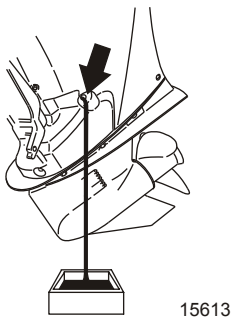

## CHANGING OIL FILTER

**IMPORTANT:** To reduce or prevent oil spillage when removing the oil filter, ensure the outboard is upright (not tilted) and the engine is cold or has not run for at least one hour.

1. Remove the top cowl.

# MAINTENANCE

2. Place a rag or towel below the oil filter to absorb any spilled oil.
3. Unscrew old filter using oil filter wrench and turning the filter counterclockwise.

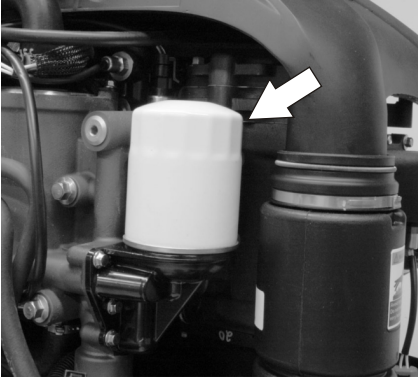

14772

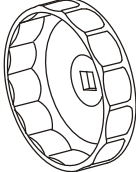
Oil Filter Wrench	91-802653Q02
 5221	Assists in removal of oil filter.

4. Clean the oil filter mounting base.
5. Apply a film of clean oil to filter gasket. Do not use grease.
6. Screw new filter on until gasket contacts base, then tighten 3/4 to 1 turn.

# MAINTENANCE

## OIL FILLING

1. Remove the oil fill cap and add recommended oil to the midpoint of the operating range (midpoint of cross hatched region). Adding approximately 6 liter (6.3 US qt) will bring oil level to midpoint of cross hatched region.

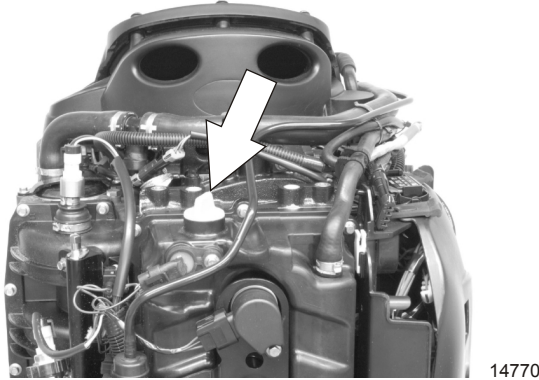

2. Install oil fill cap.
3. With outboard in water or cooling water flush hose connected, idle engine for five minutes to check for leaks at the oil filter.
4. Stop engine and check oil level. Refer to **Fuel and Oil - Checking and Adding Engine Oil**.

## Gearcase Lubrication

When adding or changing gearcase lubricant, visually check for the presence of water in the lubricant. If water is present, it may have settled to the bottom and will drain out prior to the lubricant, or it may be mixed with the lubricant, giving it a milky colored appearance. If water is noticed, have the gearcase checked by your dealer. Water in the lubricant may result in premature bearing failure or, in freezing temperatures, will turn to ice and damage the gearcase.

Examine the drained gearcase lubricant for metal particles. A small amount of metal particles indicates normal gear wear. An excessive amount of metal filings or larger particles (chips) may indicate abnormal gear wear and should be checked by an authorized dealer.

# MAINTENANCE

## DRAINING GEARCASE

1. Place outboard in a vertical operating position.
2. Remove propeller. Refer to **Propeller Replacement**.
3. Place drain pan below outboard.
4. Remove vent plug and fill/drain plug and drain lubricant.

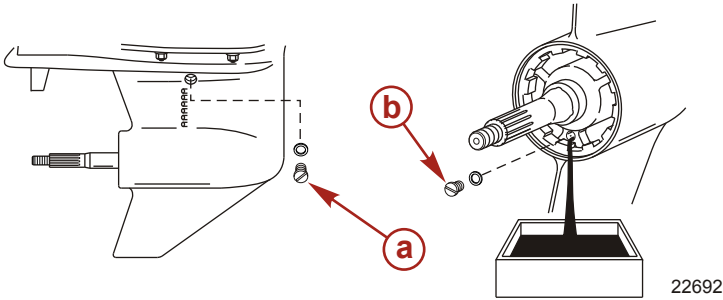

**a** - Vent plug

**b** - Fill/drain plug

## GEARCASE LUBRICANT CAPACITY

Gearcase lubricant capacity is approximately 970 ml (32.8 fl. oz.) for right hand rotation gearcases and 900 ml (30.4 fl. oz.) for left hand rotation gearcases.

## GEARCASE LUBRICANT CAPACITY

Gearcase lubricant capacity is approximately 970 ml (32.8 fl oz).

## GEARCASE LUBRICANT RECOMMENDATION

Mercury or Quicksilver High Performance Gear Lubricant.

## CHECKING LUBRICANT LEVEL AND REFILLING GEARCASE

1. Place outboard in a vertical operating position.
2. Remove vent plug/sealing washer.

## MAINTENANCE

3. Remove fill/drain plug. Place lubricant tube into the fill hole and add lubricant until it appears at the vent hole.

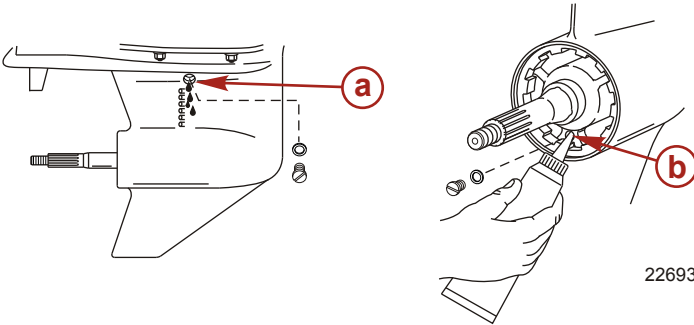

- a** - Vent hole
- b** - Fill hole

**IMPORTANT: Replace sealing washers if damaged.**

4. Stop adding lubricant. Install the vent plug and sealing washer before removing the lubricant tube.
5. Remove lubricant tube and reinstall cleaned fill/drain plug and sealing washer.

# STORAGE

## Storage Preparation

The major consideration in preparing your outboard for storage is to protect it from rust, corrosion, and damage caused by freezing of trapped water.

The following storage procedures should be followed to prepare your outboard for out of season storage or prolonged storage (two months or longer).

### *NOTICE*

**Without sufficient cooling water, the engine, the water pump, and other components will overheat and suffer damage. Provide a sufficient supply of water to the water inlets during operation.**

## FUEL SYSTEM

**IMPORTANT:** Gasoline containing alcohol (ethanol or methanol) can cause a formation of acid during storage and can damage the fuel system. If the gasoline being used contains alcohol, it is advisable to drain as much of the remaining gasoline as possible from the fuel tank, remote fuel line, and engine fuel system.

**IMPORTANT:** This outboard is equipped with a closed fuel system when the engine is not running. With this closed system, fuel within the engine's fuel system, other than the fuel tank, will remain stable during normal storage periods without the addition of fuel treatment stabilizers.

Fill the fuel tank and engine fuel system with treated (stabilized) fuel to help prevent formation of varnish and gum. Proceed with the following instructions.

- Portable fuel tank - Pour the required amount of Fuel System Treatment and Stabilizer (follow instructions on container) into fuel tank. Tip fuel tank back and forth to mix stabilizer with the fuel.
- Permanently installed fuel tank - Pour the required amount of Fuel System Treatment and Stabilizer (follow instructions on container) into a separate container and mix with approximately one liter (one quart) of gasoline. Pour this mixture into fuel tank.

# STORAGE

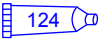
Tube Ref No.	Description	Where Used	Part No.
 124	Fuel System Treatment and Stabilizer	Fuel tank	858071K01

## Protecting External Outboard Components

- Touch up any paint nicks. See your dealer for touch-up paint.
- Spray Quicksilver or Mercury Precision Lubricants Corrosion Guard on external metal surfaces (except corrosion control anodes).

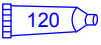
Tube Ref No.	Description	Where Used	Part No.
 120	Corrosion Guard	External metal surfaces	92-802878 55

## Protecting Internal Engine Components

**IMPORTANT: Refer to Maintenance - Spark Plug Inspection and Replacement for correct procedure for removing spark plugs.**

- Remove pencil coils and spark plugs.
- Spray approximately 30 ml (1 fl oz) of Storage Seal Rust Inhibitor into each spark plug hole.

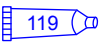
Tube Ref No.	Description	Where Used	Part No.
 119	Storage Seal Rust Inhibitor	Spark plug holes	92-858081K01

- Actuate key/push button start switch to crank the engine through one start cycle, which will distribute the storage seal throughout the cylinders.
- Install spark plugs and pencil coils.

## Gearcase

- Drain and refill the gearcase lubricant (refer to **Gearcase Lubrication**).

# STORAGE

## Positioning Outboard for Storage

Store outboard in an upright (vertical) position to allow water to drain out of the outboard.

### *NOTICE*

**Storing the outboard in a tilted position can damage the outboard. Water trapped in the cooling passages or rain water collected in the propeller exhaust outlet in the gearcase can freeze. Store the outboard in the full down position.**

## Battery Storage

- Follow the battery manufacturer's instructions for storage and recharging.
- Remove the battery from the boat and check water level. Recharge if necessary.
- Store the battery in a cool, dry place.
- Periodically check the water level and recharge the battery during storage.



# TROUBLESHOOTING

## Starter Motor Will Not Crank the Engine

### POSSIBLE CAUSES

- Lanyard stop switch not in "RUN" position.
- Blown 5 amp fuse. Check DTS power harness circuit fuse. Refer to **Maintenance** section.
- Outboard is not shifted to neutral position.
- Shift actuator failure. "Gear Shift Diff" error message shown on System View. Refer to **Maintenance** section.
- Weak battery or battery connections are loose or corroded.
- Ignition key switch failure.
- Wiring or electrical connection faulty.
- Starter motor solenoid or slave solenoid failure.

## Engine Will Not Start

### POSSIBLE CAUSES

- Incorrect starting procedure. Refer to **Operation** section.
- Old or contaminated gasoline.
- Fuel is not reaching the engine.
  - Fuel tank is empty.
  - Fuel tank vent not open or restricted.
  - Fuel line is disconnected or kinked.
  - Fuel filter is obstructed. Refer to **Maintenance** section.
  - Fuel pump failure.
  - Fuel tank filter obstructed.
- Ignition system component failure.
- Spark plugs fouled or defective. Refer to **Maintenance** section.

## Engine Starts But Will Not Shift Into Gear

- Shift actuator failure. "Gear Shift Diff" error message shown on System View. Refer to **Maintenance** section.

# TROUBLESHOOTING

## Engine Runs Erratically

### POSSIBLE CAUSES

- Overheating - Warning horn not working.
- Low oil pressure. Check oil level.
- Spark plugs fouled or defective. Refer to **Maintenance** section.
- Incorrect setup and adjustments.
- Fuel is being restricted to the engine.
  - a. Engine fuel filter is obstructed. Refer to **Maintenance** section.
  - b. Fuel tank filter obstructed.
  - c. Stuck anti-siphon valve located on permanently built-in type fuel tanks.
  - d. Fuel line is kinked or pinched.
- Fuel pump failure.
- Ignition system component failure.

## Performance Loss

### POSSIBLE CAUSES

- Overheating - Warning horn not working.
- Low oil pressure. Check oil level.
- Throttle not opening fully.
- Damaged propeller or improper propeller size.
- Incorrect engine timing, adjustment, or setup.
- Boat overloaded or load improperly distributed.
- Excessive water in bilge.
- Boat bottom is dirty or damaged.

## Battery Will Not Hold Charge

### POSSIBLE CAUSES

- Battery connections are loose or corroded.
- Low electrolyte level in battery.
- Worn out or inefficient battery.
- Excessive use of electrical accessories.

## TROUBLESHOOTING

- Defective rectifier, alternator, or voltage regulator.
- Open circuit in the alternator output wire (fused link).

# OWNER SERVICE ASSISTANCE

## Local Repair Service

Always return your outboard to your local authorized dealer should the need for service arise. Only he has the factory trained mechanics, knowledge, special tools, equipment, and genuine parts and accessories to properly service your engine should the need occur. He knows your engine best.

## Service Away from Home

If you are away from your local dealer and the need arises for service, contact the nearest authorized dealer. Refer to the Yellow Pages of the telephone directory. If, for any reason, you cannot obtain service, contact the nearest Mercury Marine Service Office.

## Parts and Accessories Inquiries

All inquiries concerning genuine replacement parts and accessories should be directed to your local authorized dealer. The dealer has the necessary information to order parts and accessories for you. When inquiring on parts and accessories, the dealer requires the model and serial number to order the correct parts.

## Service Assistance

Your satisfaction with your outboard product is very important to your dealer and to us. If you ever have a problem, question or concern about your outboard product, contact your dealer or any authorized Mercury Marine dealership. If additional assistance is required, take these steps.

1. Talk with the dealership's sales manager or service manager. If this has already been done, then contact the owner of the dealership.
2. Should you have a question, concern, or problem that cannot be resolved by your dealership, please contact Mercury Marine Service Office for assistance. Mercury Marine will work with you and your dealership to resolve all problems.

The following information will be needed by the service office:

- Your name and address
- Daytime telephone number

## OWNER SERVICE ASSISTANCE

- Model and serial number of your outboard
- The name and address of your dealership
- Nature of problem

### Mercury Marine Service Offices

For assistance, call, fax, or write. Please include your daytime telephone number with mail and fax correspondence.

<b>United States, Canada</b>		
Telephone	English - (920) 929-5040 Français - (905) 636-4751	Mercury Marine W6250 W. Pioneer Road P.O. Box 1939 Fond du Lac, WI 54936-1939
Fax	English - (920) 929-5893 Français - (905) 636-1704	
Website	www.mercurymarine.com	

<b>Australia, Pacific</b>		
Telephone	(61) (3) 9791-5822	Mercury Marine Australia 132-140 Frankston Road Dandenong, Victoria 3164 Australia
Fax	(61) (3) 9793-5880	

<b>Europe, Middle East, Africa</b>		
Telephone	(32) (87) 32 • 32 • 11	Marine Power - Europe, Inc. Parc Industriel de Petit-Rechain B-4800 Verviers, Belgium
Fax	(32) (87) 31 • 19 • 65	

<b>Mexico, Central America, South America, Caribbean</b>		
Telephone	(954) 744-3500	Mercury Marine 11650 Interchange Circle North Miramar, FL 33025 U.S.A.
Fax	(954) 744-3535	

<b>Japan</b>		
Telephone	81-053-423-2500	Mercury Marine - Japan Anshin-cho 283-1 Hamamatsu Shizuoka-ken, Japan 435-0005 Japan
Fax	81-053-423-2510	

## OWNER SERVICE ASSISTANCE

Asia, Singapore		
Telephone	5466160	Mercury Marine Singapore 72 Loyang Way Singapore, 508762
Fax	5467789	