

## Welcome Aboard!

Proper care and maintenance is an important part in keeping your Mercury Product operating at peak efficiency for maximum performance and economy. The enclosed Owner's Registration Card is your key to trouble-free family fun. Refer to your **Operation and Maintenance Manual** for full details of your warranty coverage.

Details of your nearest dealer can be found on [www.marinepower.com](http://www.marinepower.com) where country maps and full contact information are displayed.

Is your engine properly registered for warranty purpose? Please check on [www.marinepower.com](http://www.marinepower.com). If necessary, please contact your local dealer.

## Declaration of Conformity

This outboard motor's serial number plate contains in the lower corner left hand corner either the CE mark alone or the CE mark accompanied by a notified body number. This outboard motor manufactured by Mercury Marine, Fond du Lac, WI, USA or Marine Power Europe Inc. Park Industriel, de Petit-Rechain, Belgium complies with the requirements of the following directives by meeting the associated standards, as amended:

If the CE mark is accompanied by a notified body number, the following Recreational Craft Directive applies:

### Recreational Craft Directive: 2003/44/EC amending 94/25/EC

Owner's manual (A.2.5)	ISO 10240
Handling characteristics (A.4)	ISO 8665
Outboard engine starting (A.5.1.4)	ISO 11547
Fuel tanks (A.5.2.2)	ISO 13591; ISO 8469
General steering system	ABYC P-17
Exhaust emission requirements (B.2)	ISO 8178
Owner's manual (B.4)	ISO 8665
Noise emission levels (C.1)	ISO 14509

The notified body responsible for surveillance of the quality system under Full Quality Assurance Module H of Directive 2003/44/EC is:

Det Norske Veritas

Norway

Notified Body Number: 0575

If the CE mark is not accompanied by a notified body number, the following Recreational Craft Directive language applies:

### Recreational Craft Directive: 94/25/EC

Owner's manual (A.2.5)	ISO 10240
Handling characteristics (A.4)	ISO 8665
Outboard engine starting (A.5.1.4)	ISO 11547
Fuel tanks (A.5.2.2)	ISO 13591; ISO 8469

General steering system	ABYC P-17
-------------------------	-----------

The following applies to all product covered by this manual:

**Safety of Machinery Directive**

**98/37/EC**

Principles of safety integration (1.1.2)	EN 292-1; EN 292-2; EN 1050
Noise (1.5.8)	ICOMIA 39/94
Vibration	ICOMIA 38/94

**Electromagnetic Compatibility Directive 89/336/EC**

Generic emission standard	EN 61000-6-3
Generic immunity standard	EN 61000-6-1
Vehicles, boats and internal combustion engine driven devices - radio disturbance characteristics	SAE J551 (CISPR 12)
Electrostatic discharge testing	EN 61000-6-2; EN 61000-4-2; EN 61000-4-3

This declaration is issued under the sole responsibility of Mercury Marine and Marine Power Europe.



Patrick C. Mackey

President, Mercury Marine, Fond du Lac, WI USA

European Regulations Contact:

Regulations and Product Safety Department, Mercury Marine,

Fond du Lac, WI USA

# TABLE OF CONTENTS

---

## Warranty Information

---

Transfer Of Warranty.....	1
Warranty Registration United States And Canada.....	1
Warranty Registration Outside The United States And Canada.....	1
Optimax Outboard Limited Warranty United States, Canada, Europe, Confederation of Independent States, Middle-East and Africa.....	2
3 Year Limited Warranty Against Corrosion.....	3
Warranty Coverage And Exclusions.....	5

---

## General Information

---

Boater's Responsibilities.....	6
Before Operating Your Outboard.....	6
Boat Horsepower Capacity.....	6
High-Speed And High-Performance Boat Operation.....	7
Outboard Remote Control Models.....	7
Remote Steering Notice.....	7
Lanyard Stop Switch.....	8
Protecting People In The Water.....	9
Passenger Safety Message - Pontoon Boats And Deck Boats.....	10
Wave And Wake Jumping.....	10
Impact With Underwater Hazards.....	11
Exhaust Emissions.....	12
Selecting Accessories For Your Outboard.....	13
Safe Boating Suggestions.....	13
Recording Serial Number.....	14
200/225 OptiMax DTS Specifications.....	14
Component Identification.....	16

---

## Installation

---

Installing Outboard.....	17
Propeller Selection.....	17

---

## Transporting

---

Trailer Boat/Outboard.....	19
----------------------------	----

---

## Fuel and Oil

---

Fuel Recommendations.....	20
Fuel Additives.....	20
Fuel Requirements.....	21
Avoiding Fuel Flow Restriction.....	21
Filling Fuel Tank.....	21
Oil Recommendation.....	21
Filling Remote Oil Tank.....	21
Filling Engine Mounted Oil Reservoir Tank.....	21

# TABLE OF CONTENTS

---

## Features and Controls

---

Warning System.....	23
Remote Control Features.....	25
Power Trim and Tilt.....	31

---

## Operation

---

Pre-Starting Check List.....	35
Operating In Freezing Temperatures.....	35
Operating In Salt Water Or Polluted Water.....	35
Operating at High Elevations.....	35
Setting Trim Angle While Running Engine at Idle Speed.....	35
Engine Break-in Procedure.....	36
Starting The Engine.....	36
Gear Shifting.....	50
Dual Helm Station Transfer.....	51
Synchronizing Dual Engines.....	52
Stopping The Engine.....	52
Remote Control Adjustments.....	53

---

## Maintenance

---

Outboard Care.....	54
EPA Emissions.....	54
Inspection And Maintenance Schedule.....	55
Flushing The Cooling System.....	55
Top Cowl Removal And Installation.....	56
Cleaning Care for Top Cowl.....	56
Alternator Belt Inspection.....	57
Fuel System.....	57
Steering Link Rod Fasteners.....	59
Fuse Replacement.....	59
DTS Wiring System.....	60
Corrosion Control Anode.....	60
Battery Inspection.....	61
Battery Information.....	61
Propeller Replacement.....	62
Spark Plug Inspection And Replacement.....	65
Compressor Air Intake Filter.....	65
Lubrication Points.....	66
Checking Power Trim Fluid.....	69
Gearcase Lubrication.....	69
Submerged Outboard.....	70

---

## Storage

---

Storage Preparation.....	71
Protecting Internal Engine Components.....	72
Protecting External Outboard Components.....	73
Gearcase.....	73
Positioning Outboard For Storage.....	73

# TABLE OF CONTENTS

Battery Storage.....	73
----------------------	----

---

## Troubleshooting

---

Starter Motor Will Not Crank the Engine.....	74
Engine Will Not Start.....	74
Engine Starts But Will Not Shift Into Gear.....	74
Engine Runs Erratically.....	74
Performance Loss.....	75
Battery Will Not Hold Charge.....	75

---

## Owner Service Assistance

---

Local Repair Service.....	76
Service Away From Home.....	76
Parts And Accessories Inquiries.....	76
Service Assistance.....	76
Mercury Marine Service Offices.....	76



# WARRANTY INFORMATION

## Transfer Of Warranty

The limited warranty is transferable to a subsequent purchaser, but only for the remainder of the unused portion of the limited warranty. This will not apply to products used for commercial applications.

To transfer the warranty to the subsequent owner, send or fax a copy of the bill of sale or purchase agreement, new owner's name, address and engine serial number to Mercury Marine's warranty registration department. In the United States and Canada, mail to:

Mercury Marine  
Attn: Warranty Registration Department  
W6250 W. Pioneer Road  
P.O. Box 1939  
Fond du Lac, WI 54936-1939  
920-929-5054  
Fax 920-929-5893

Upon processing the transfer of warranty, Mercury Marine will send registration verification to the new owner of the product by mail.

There is no charge for this service.

For products purchased outside the United States and Canada, contact the distributor in your country, or the Marine Power Service Center closest to you.

## Warranty Registration United States And Canada

*Outside United States and Canada - Check with your local distributor.*

1. You may change your address at any time, including at time of warranty claim, by calling Mercury Marine or sending a letter or fax with your name, old address, new address, and engine serial number to Mercury Marine's warranty registration department. Your dealer can also process this change of information.

Mercury Marine  
Attn: Warranty Registration Department  
W6250 W. Pioneer Road  
P.O. Box 1939  
Fond du Lac, WI 54936-1939  
920-929-5054  
Fax 920-929-5893

**NOTE:** *Registration lists must be maintained by Mercury Marine and any dealer on marine products sold in the United States, should a safety recall notification under the Federal Safety Act be required.*

2. To be eligible for warranty coverage, the product must be registered with Mercury Marine. At the time of sale, the dealer should complete the warranty registration and immediately submit it to Mercury Marine via MercNET, E-mail, or mail. Upon receipt of this warranty registration, Mercury Marine will record the registration.
3. Upon processing the warranty registration, Mercury Marine will send registration verification by mail to the purchaser of the product. If this registration verification is not received within 30 days, please contact your selling dealer immediately. Warranty coverage is not effective until your product is registered with Mercury Marine.

## Warranty Registration Outside The United States And Canada

1. It is important that your selling dealer fills out the Warranty Registration Card completely and mails it to the distributor or Marine Power Service Center responsible for administering the warranty registration/claim program for your area.
2. The Warranty Registration Card identifies your name and address, product model and serial numbers, date of sale, type of use and the selling distributor's/dealer's code number, name and address. The distributor/dealer also certifies that you are the original purchaser and user of the product.

# WARRANTY INFORMATION

3. A copy of the Warranty Registration Card, designated as the Purchaser's Copy, MUST be given to you immediately after the card has been completely filled out by the selling distributor/dealer. This card represents your factory registration identification, and should be retained by you for future use when required. Should you ever require warranty service on this product, your dealer may ask you for the Warranty Registration Card to verify date of purchase and to use the information on the card to prepare the warranty claim forms.
4. In some countries, the Marine Power Service Center will issue you a permanent (plastic) Warranty Registration Card within 30 days after receiving the Factory Copy of the Warranty Registration Card from your distributor/dealer. If you receive a plastic Warranty Registration Card, you may discard the Purchaser's Copy that you received from the distributor/dealer when you purchased the product. Ask your distributor/dealer if this plastic card program applies to you.

**IMPORTANT: Registration lists must be maintained by the factory and dealer in some countries by law. It is our desire to have ALL products registered at the factory should it ever be necessary to contact you. Make sure your dealer/distributor fills out the warranty registration card immediately and sends the factory copy to the Marine Power International Service Center for your area.**

5. For further information concerning the Warranty Registration Card and its relationship to Warranty Claim processing, refer to the International Warranty.

## Optimax Outboard Limited Warranty United States, Canada, Europe, Confederation of Independent States, Middle-East and Africa

Outside the United States, Canada, Europe, Confederation of Independent States, Middle-East and Africa - check with your local distributor.

**WHAT IS COVERED:** Mercury Marine warrants its new Outboard and Jet Products to be free of defects in material and workmanship during the period described below.

**DURATION OF COVERAGE:** This Limited Warranty provides coverage for three (3) years from the date the product is first sold to a recreational use retail purchaser, or the date on which the product is first put into service, whichever occurs first. Commercial users of these products receive warranty coverage of one (1) year from the date of first retail sale, or one (1) year from the date in which the product was first put into service, whichever occurs first. Commercial use is defined as any work or employment related use of the product, or any use of the product which generates income, for any part of the warranty period, even if the product is only occasionally used for such purposes. The repair or replacement of parts, or the performance of service under this warranty, does not extend the life of this warranty beyond its original expiration date. Unexpired warranty coverage can be transferred from one recreational use customer to a subsequent recreational use customer upon proper re-registration of the product. Unexpired warranty coverage cannot be transferred either to or from a commercial use customer.

**CONDITIONS THAT MUST BE MET IN ORDER TO OBTAIN WARRANTY COVERAGE:** Warranty coverage is available only to retail customers that purchase from a Dealer authorized by Mercury Marine to distribute the product in the country in which the sale occurred, and then only after the Mercury Marine specified pre-delivery inspection process is completed and documented. Warranty coverage becomes available upon proper registration of the product by the authorized dealer. Routine maintenance outlined in the Operation and Maintenance Manual must be timely performed in order to maintain warranty coverage. Mercury Marine reserves the right to make future warranty coverage contingent on proof of proper maintenance.

**WHAT MERCURY WILL DO:** Mercury's sole and exclusive obligation under this warranty is limited to, at our option, repairing a defective part, replacing such part or parts with new or Mercury Marine certified remanufactured parts, or refunding the purchase price of the Mercury product. Mercury reserves the right to improve or modify products from time to time without assuming an obligation to modify products previously manufactured.

**HOW TO OBTAIN WARRANTY COVERAGE:** The customer must provide Mercury with a reasonable opportunity to repair, and reasonable access to the product for warranty service. Warranty claims shall be made by delivering the product for inspection to a Mercury dealer authorized to service the product. If purchaser cannot deliver the product to such a dealer, written notice must be given to Mercury. We will then arrange for the inspection and any covered repair. Purchaser in that case shall pay for all related transportation charges and/or travel time. If the service provided is not covered by this warranty, purchaser shall pay for all related labor and material, and any other expenses associated with that service. Purchaser shall not, unless requested by Mercury, ship the product or parts of the product directly to Mercury. Proof of registered ownership must be presented to the dealer at the time warranty service is requested in order to obtain coverage.



# WARRANTY INFORMATION

**WHAT IS NOT COVERED:** This limited warranty does not cover routine maintenance items, tune ups, adjustments, normal wear and tear, damage caused by abuse, abnormal use, use of a propeller or gear ratio that does not allow the engine to run in its recommended wide open throttle RPM range (see the Operation and Maintenance Manual), operation of the product in a manner inconsistent with the recommended operation/duty cycle section of the Operation and Maintenance Manual, neglect, accident, submersion, improper installation (proper installation specifications and techniques are set forth in the installation instructions for the product), improper service, use of an accessory or part not manufactured or sold by us, jet pump impellers and liners, operation with fuels, oils or lubricants which are not suitable for use with the product (see the Operation and Maintenance Manual), alteration or removal of parts, or water entering the engine through the fuel intake, air intake or exhaust system, or damage to the product from insufficient cooling water caused by blockage of the cooling system by a foreign body, running the engine out of water, mounting the engine too high on the transom, or running the boat with the engine trimmed out too far.. Use of the product for racing or other competitive activity, or operating with a racing type lower unit, at any point, even by a prior owner of the product, voids the warranty.

Expenses related to haul out, launch, towing, storage, telephone, rental, inconvenience, slip fees, insurance coverage, loan payments, loss of time, loss of income, or any other type of incidental or consequential damages are not covered by this warranty. Also, expenses associated with the removal and/or replacement of boat partitions or material caused by boat design for access to the product are not covered by this warranty.

No individual or entity, including Mercury Marine authorized dealers, has been given authority by Mercury Marine to make any affirmation, representation or warranty regarding the product, other than those contained in this limited warranty, and if made, shall not be enforceable against Mercury Marine.

For additional information regarding events and circumstances covered by this warranty, and those that are not, see the Warranty Coverage section of the Operation and Maintenance Manual, incorporated by reference into this warranty.

## DISCLAIMERS AND LIMITATIONS:

THE IMPLIED WARRANTIES OF MERCHANTABILITY AND FITNESS FOR A PARTICULAR PURPOSE ARE EXPRESSLY DISCLAIMED. TO THE EXTENT THAT THEY CANNOT BE DISCLAIMED, THE IMPLIED WARRANTIES ARE LIMITED IN DURATION TO THE LIFE OF THE EXPRESS WARRANTY. INCIDENTAL AND CONSEQUENTIAL DAMAGES ARE EXCLUDED FROM COVERAGE UNDER THIS WARRANTY. SOME STATES/COUNTRIES DO NOT ALLOW FOR THE DISCLAIMERS, LIMITATIONS AND EXCLUSIONS IDENTIFIED ABOVE, AS A RESULT, THEY MAY NOT APPLY TO YOU. THIS WARRANTY GIVES YOU SPECIFIC LEGAL RIGHTS, AND YOU MAY ALSO HAVE OTHER LEGAL RIGHTS WHICH VARY FROM STATE TO STATE AND COUNTRY TO COUNTRY.

## 3 Year Limited Warranty Against Corrosion

**WHAT IS COVERED:** Mercury Marine warrants that each new Mercury, Mariner, Mercury Racing, Sport Jet, M<sup>2</sup> Jet Drive, Tracker by Mercury Marine Outboard, MerCruiser Inboard or sterndrive engine (Product) will not be rendered inoperative as a direct result of corrosion for the period of time described below.

**DURATION OF COVERAGE:** This limited corrosion warranty provides coverage for three (3) years from either the date the product is first sold, or the date on which the product is first put into service, whichever occurs first. The repair or replacement of parts, or the performance of service under this warranty does not extend the life of this warranty beyond its original expiration date. Unexpired warranty coverage can be transferred to subsequent (non-commercial use) purchaser upon proper re-registration of the product.

# WARRANTY INFORMATION

**CONDITIONS THAT MUST BE MET IN ORDER TO OBTAIN WARRANTY COVERAGE:** Warranty coverage is available only to retail customers that purchase from a Dealer authorized by Mercury Marine to distribute the product in the country in which the sale occurred, and then only after the Mercury Marine specified pre-delivery inspection process is completed and documented. Warranty coverage becomes available upon proper registration of the product by the authorized dealer. Corrosion prevention devices specified in the Operation and Maintenance Manual must be in use on the boat, and routine maintenance outlined in the Operation and Maintenance Manual must be timely performed (including without limitation the replacement of sacrificial anodes, use of specified lubricants, and touch-up of nicks and scratches) in order to maintain warranty coverage. Mercury Marine reserves the right to make warranty coverage contingent upon proof of proper maintenance.

**WHAT MERCURY WILL DO:** Mercury's sole and exclusive obligation under this warranty is limited to, at our option, repairing a corroded part, replacing such part or parts with new or Mercury Marine certified re-manufactured parts, or refunding the purchase price of the Mercury product. Mercury reserves the right to improve or modify products from time to time without assuming an obligation to modify products previously manufactured.

**HOW TO OBTAIN WARRANTY COVERAGE:** The customer must provide Mercury with a reasonable opportunity to repair, and reasonable access to the product for warranty service. Warranty claims shall be made by delivering the product for inspection to a Mercury dealer authorized to service the product. If purchaser cannot deliver the product to such a dealer, written notice must be given to Mercury. We will then arrange for the inspection and any covered repair. Purchaser in that case shall pay for all related transportation charges and/or travel time. If the service provided is not covered by this warranty, purchaser shall pay for all related labor and material, and any other expenses associated with that service. Purchaser shall not, unless requested by Mercury, ship the product or parts of the product directly to Mercury. Proof of registered ownership must be presented to the dealer at the time warranty service is requested in order to obtain coverage.

**WHAT IS NOT COVERED:** This limited warranty does not cover electrical system corrosion; corrosion resulting from damage, corrosion which causes purely cosmetic damage, abuse or improper service; corrosion to accessories, instruments, steering systems; corrosion to factory installed jet drive unit; damage due to marine growth; product sold with less than a one year limited Product warranty; replacement parts (parts purchased by customer); products used in a commercial application. Commercial use is defined as any work or employment related use of the product, or any use of the product which generates income, for any part of the warranty period, even if the product is only occasionally used for such purposes.

Corrosion damage caused by stray electrical currents (on-shore power connections, nearby boats, submerged metal) is not covered by this corrosion warranty and should be protected against by the use of a corrosion protection system, such as the Mercury Precision Parts or Quicksilver MerCathode system and/or Galvanic Isolator. Corrosion damage caused by improper application of copper base anti-fouling paints is also not covered by this limited warranty. If anti-fouling protection is required, Tri-Butyl-Tin-Adipate (TBTA) base anti-fouling paints are recommended on Outboard and MerCruiser boating applications. In areas where TBTA base paints are prohibited by law, copper base paints can be used on the hull and transom. Do not apply paint to the outboard or MerCruiser product. In addition, care must be taken to avoid an electrical interconnection between the warranted product and the paint. For MerCruiser product, an unpainted gap of at least 38 mm (1.5 in.) should be left around the transom assembly. Refer to the Operation and Maintenance Manual for additional details.

For additional information regarding events and circumstances covered by this warranty, and those that are not, see the Warranty Coverage section of the Operation and Maintenance Manual, incorporated by reference into this warranty.

## DISCLAIMERS AND LIMITATIONS:

**THE IMPLIED WARRANTIES OF MERCHANTABILITY AND FITNESS FOR A PARTICULAR PURPOSE ARE EXPRESSLY DISCLAIMED. TO THE EXTENT THAT THEY CANNOT BE DISCLAIMED, THE IMPLIED WARRANTIES ARE LIMITED IN DURATION TO THE LIFE OF THE EXPRESS WARRANTY. INCIDENTAL AND CONSEQUENTIAL DAMAGES ARE EXCLUDED FROM COVERAGE UNDER THIS WARRANTY. SOME STATES/COUNTRIES DO NOT ALLOW FOR THE DISCLAIMERS, LIMITATIONS AND EXCLUSIONS IDENTIFIED ABOVE, AS A RESULT, THEY MAY NOT APPLY TO YOU. THIS WARRANTY GIVES YOU SPECIFIC LEGAL RIGHTS, AND YOU MAY ALSO HAVE OTHER LEGAL RIGHTS WHICH VARY FROM STATE TO STATE AND COUNTRY TO COUNTRY.**

# WARRANTY INFORMATION

## Warranty Coverage And Exclusions

The purpose of this section is to help eliminate some of the more common misunderstandings regarding warranty coverage. The following information explains some of the types of services that are not covered by warranty. The provisions set forth following have been incorporated by reference into the Three Year Limited Warranty Against Corrosion Failure, the International Limited Outboard Warranty, and the United States and Canada Limited Outboard Warranty.

Keep in mind that warranty covers repairs that are needed within the warranty period because of defects in material and workmanship. Installation errors, accidents, normal wear, and a variety of other causes that affect the product are not covered.

Warranty is limited to defects in material or workmanship, but only when the consumer sale is made in the country to which distribution is authorized by us.

Should you have any questions concerning warranty coverage, contact your authorized dealer. They will be pleased to answer any questions that you may have.

## GENERAL EXCLUSIONS FROM WARRANTY

1. Minor adjustments and tune-ups, including checking, cleaning or adjusting spark plugs, ignition components, carburetor settings, filters, belts, controls, and checking lubrication made in connection with normal services.
2. Factory installed jet drive units - Specific parts excluded from the warranty are: The jet drive impeller and jet drive liner damaged by impact or wear, and water damaged drive shaft bearings as a result of improper maintenance.
3. Damage caused by neglect, lack of maintenance, accident, abnormal operation or improper installation or service.
4. Haul out, launch, towing charges, removal and/or replacement of boat partitions or material because of boat design for necessary access to the product, all related transportation charges and/or travel time, etc. Reasonable access must be provided to the product for warranty service. Customer must deliver product to an authorized dealer.
5. Additional service work requested by customer other than that necessary to satisfy the warranty obligation.
6. Labor performed by other than an authorized dealer may be covered only under following circumstances: When performed on emergency basis (providing there are no authorized dealers in the area who can perform the work required or have no facilities to haul out, etc., and prior factory approval has been given to have the work performed at this facility).
7. All incidental and/or consequential damages (storage charges, telephone or rental charges of any type, inconvenience or loss of time or income) are the owner's responsibility.
8. Use of other than Mercury Precision or Quicksilver parts when making warranty repairs.
9. Oils, lubricants or fluids changed as a matter of normal maintenance is customer's responsibility unless loss or contamination of same is caused by product failure that would be eligible for warranty consideration.
10. Participating in or preparing for racing or other competitive activity or operating with a racing type lower unit.
11. Engine noise does not necessarily indicate a serious engine problem. If diagnosis indicates a serious internal engine condition which could result in a failure, condition responsible for noise should be corrected under the warranty.
12. Lower unit and/or propeller damage caused by striking a submerged object is considered a marine hazard.
13. Water entering engine through the fuel intake, air intake or exhaust system or submersion.
14. Failure of any parts caused by lack of cooling water, which results from starting motor out of water, foreign material blocking inlet holes, motor being mounted too high or trimmed too far out.
15. Use of fuels and lubricants which are not suitable for use with or on the product. Refer to the **Maintenance** section.
16. Our limited warranty does not apply to any damage to our products caused by the installation or use of parts and accessories which are not manufactured or sold by us. Failures which are not related to the use of those parts or accessories are covered under warranty if they otherwise meet the terms of the limited warranty for that product.

# GENERAL INFORMATION

## Boater's Responsibilities

The operator (driver) is responsible for the correct and safe operation of the boat and safety of its occupants and general public. It is strongly recommended that each operator (driver) read and understand this entire manual before operating the outboard.

Be sure at least one additional person on board is instructed in the basics of starting and operating the outboard and boat handling in case the driver is unable to operate the boat.

## Before Operating Your Outboard

Read this manual carefully. Learn how to operate your outboard properly. If you have any questions, contact your dealer.

Safety and operating information that is practiced, along with using good common sense, can help prevent personal injury and product damage.

This manual as well as safety labels posted on the outboard use the following safety alerts to draw your attention to special safety instructions that should be followed.

### **DANGER**

**DANGER** - indicates an imminently hazardous situation that, if not avoided, will result in death or serious injury.

### **WARNING**

**WARNING** - indicates a potentially hazardous situation that, if not avoided, could result in death or serious injury.

### **CAUTION**

**CAUTION** - indicates a potentially hazardous situation that, if not avoided, may result in minor or moderate injury or property damage. It may also be used to alert against unsafe practices.

## Boat Horsepower Capacity

### **WARNING**

Using an outboard that exceeds the maximum horsepower limit of a boat can: 1) cause loss of boat control 2) place too much weight at the transom altering the designed flotation characteristics of the boat or 3) cause the boat to break apart particularly around the transom area. Overpowering a boat can result in serious injury, death or boat damage.

Do not overpower or overload your boat. Most boats will carry a required capacity plate indicating the maximum acceptable power and load as determined by the manufacturer following certain federal guidelines. If in doubt, contact your dealer or the boat manufacturer.

# GENERAL INFORMATION

U.S. COAST GUARD CAPACITY	
MAXIMUM HORSEPOWER	XXX
MAXIMUM PERSON CAPACITY (POUNDS)	XXX
MAXIMUM WEIGHT CAPACITY	XXX

ob00306

## High-Speed And High-Performance Boat Operation

If your outboard is to be used on a high speed or high performance boat with which you are unfamiliar, we recommend that you never operate it at its high speed capability without first requesting an initial orientation and familiarization demonstration ride with your dealer or an operator experienced with your boat/outboard combination. For additional information, obtain a copy of our **Hi-Performance Boat Operation** booklet from your dealer, distributor, or Mercury Marine.

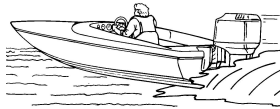

ob00307

## Outboard Remote Control Models

The outboard must be equipped with a Mercury remote control designed for digital throttle and shift. Start in gear protection is provided by the control system. This prevents the engine from starting when the shift is actuated in any position other than neutral.

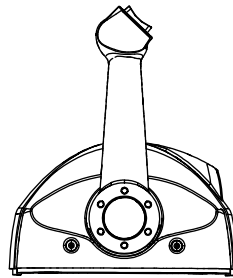
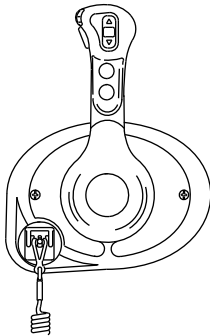

ob01482

## Remote Steering Notice

The steering link rod that connects the steering cable to the engine must be fastened utilizing self-locking nuts. These self-locking nuts must never be replaced with common nuts (non-locking) as they will work loose and vibrate off, freeing the link rod to disengage.

# GENERAL INFORMATION

## ⚠ WARNING

Disengagement of a steering link rod can result in the boat taking a full, sudden, sharp turn. This potentially violent action can cause occupants to be thrown overboard exposing them to serious injury or death.

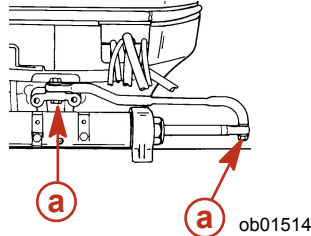

a- Self-locking nuts

## Lanyard Stop Switch

The purpose of a lanyard stop switch is to turn off the engine when the operator moves far enough away from the operator's position (as in accidental ejection from the operator's position) to activate the switch. Tiller handle outboards and some remote control units are equipped with a lanyard stop switch. A lanyard stop switch can be installed as an accessory - generally on the dashboard or side adjacent to the operator's position.

The lanyard is a cord usually between 122 and 152 cm (4 and 5 feet) in length when stretched out, with an element on one end made to be inserted into the switch and a snap on the other end for attaching to the operator. The lanyard is coiled to make its at-rest condition as short as possible to minimize the likelihood of lanyard entanglement with nearby objects. Its stretched-out length is made to minimize the likelihood of accidental activation should the operator choose to move around in an area close to the normal operator's position. If it is desired to have a shorter lanyard, wrap the lanyard around the operator's wrist or leg, or tie a knot in the lanyard.

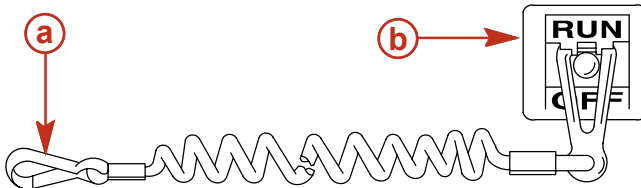

a- Lanyard cord

b- Lanyard stop switch

Read the following Safety Information before proceeding.

**Important Safety Information:** The purpose of a lanyard stop switch is to stop the engine when the operator moves far enough away from the operator's position to activate the switch. This would occur if the operator accidentally falls overboard or moves within the boat a sufficient distance from the operator's position. Falling overboard and accidental ejections are more likely to occur in certain types of boats such as low sided inflatables, bass boats, high performance boats, and light, sensitive handling fishing boats operated by a hand tiller. Falling overboard and accidental ejections are also likely to occur as a result of poor operating practices such as sitting on the back of the seat or gunwale at planing speeds, standing at planing speeds, sitting on elevated fishing boat decks, operating at planing speeds in shallow or obstacle infested waters, releasing your grip on a steering wheel or tiller handle that is pulling in one direction, drinking alcohol or consuming drugs, or daring high speed boat maneuvers.

# GENERAL INFORMATION

While activation of the lanyard stop switch will stop the engine immediately, a boat will continue to coast for some distance depending upon the velocity and degree of any turn at shut down. However, the boat will not complete a full circle. While the boat is coasting, it can cause injury to anyone in the boat's path as seriously as the boat would when under power.

We strongly recommend that other occupants be instructed on proper starting and operating procedures should they be required to operate the engine in an emergency (e.g. if the operator is accidentally ejected).

## **⚠ WARNING**

**Should the operator fall out of the boat, the possibility of serious injury or death from being run over by the boat can be greatly reduced by stopping the engine immediately. Always properly connect both ends of the stop switch lanyard to the stop switch and the operator.**

## **⚠ WARNING**

**Avoid serious injury or death from deceleration forces resulting from accidental or unintended stop switch activation. The boat operator should never leave the operator's station without first disconnecting the stop switch lanyard from the operator.**

Accidental or unintended activation of the switch during normal operation is also a possibility. This could cause any, or all, of the following potentially hazardous situations:

- Occupants could be thrown forward due to unexpected loss of forward motion - a particular concern for passengers in the front of the boat who could be ejected over the bow and possibly struck by the gearcase or propeller.
- Loss of power and directional control in heavy seas, strong current or high winds.
- Loss of control when docking.

## Protecting People In The Water

### WHILE YOU ARE CRUISING

It is very difficult for a person standing or floating in the water to take quick action to avoid a boat heading in his/her direction, even at slow speed.



ob00311

Always slow down and exercise extreme caution any time you are boating in an area where there might be people in the water.

Whenever a boat is moving (coasting) and the outboard gear shift is in neutral position, there is sufficient force by the water on the propeller to cause the propeller to rotate. This neutral propeller rotation can cause serious injury.

### WHILE BOAT IS STATIONARY

## **⚠ WARNING**

**Stop your engine immediately whenever anyone in the water is near your boat. Serious injury to the person in the water is likely if contacted by a rotating propeller, a moving boat, a moving gearcase, or any solid device rigidly attached to a moving boat or gearcase.**

# GENERAL INFORMATION

Shift outboard into neutral and shut off the engine before allowing people to swim or be in the water near your boat.

## Passenger Safety Message - Pontoon Boats And Deck Boats

Whenever the boat is in motion, observe the location of all passengers. Do not allow any passengers to stand or use seats other than those designated for traveling faster than idle speed. A sudden reduction in boat speed, such as plunging into a large wave or wake, a sudden throttle reduction, or a sharp change of boat direction, could throw them over the front of the boat. Falling over the front of the boat between the two pontoons will position them to be run over by the outboard.

### BOATS HAVING AN OPEN FRONT DECK

No one should ever be on the deck in front of the fence while the boat is in motion. Keep all passengers behind the front fence or enclosure.

Persons on the front deck could easily be thrown overboard or persons dangling their feet over the front edge could get their legs caught by a wave and pulled into the water.

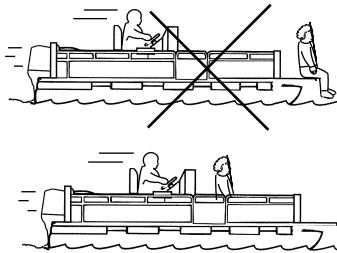

ob00312

## **⚠ WARNING**

**Avoid serious injury or death from falling over the front end of a pontoon or deck boat and being run over. Stay back from the front end of the deck and remain seated while the boat is in motion.**

### BOATS WITH FRONT MOUNTED, RAISED PEDESTAL FISHING SEATS

Elevated fishing seats are not intended for use when the boat is traveling faster than idle or trolling speed. Sit only in seats designated for traveling at faster speeds.

Any unexpected, sudden reduction in boat speed could result in the elevated passenger falling over the front of the boat.

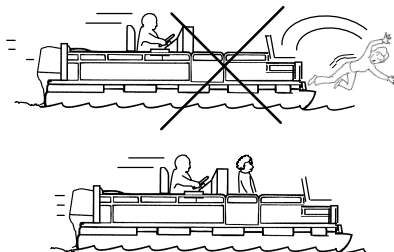

ob00313

## Wave And Wake Jumping

Operating recreational boats over waves and wake is a natural part of boating. However, when this activity is done with sufficient speed to force the boat hull partially or completely out of the water, certain hazards arise, particularly when the boat re-enters the water.



# GENERAL INFORMATION

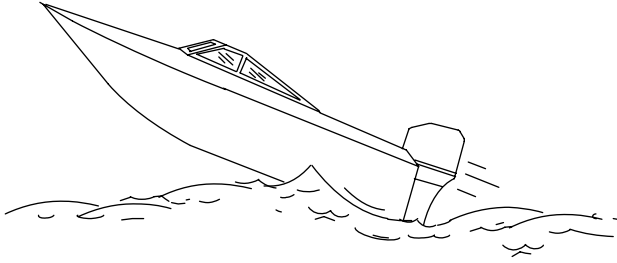

ob00314

The primary concern is the boat changing direction while in the midst of the jump. In such case the landing may cause the boat to veer violently in a new direction. Such a sharp change in direction can cause occupants to be thrown out of their seats, or out of the boat.

## WARNING

**Avoid serious injury or death from being thrown within or out of a boat when it lands after jumping a wave or wake. Avoid wave or wake jumping whenever possible. Instruct all occupants that if a wake or wave jump occurs, get low and hang on to a boat hand hold.**

There is another less common hazardous result from allowing your boat to launch off a wave or wake. If the bow of your boat pitches down far enough while airborne, upon water contact it may penetrate under the water surface and submarine for an instant. This will bring the boat to a nearly instantaneous stop and can send the occupants flying forward. The boat may also steer sharply to one side.

## Impact With Underwater Hazards

Reduce speed and proceed with caution whenever you drive a boat in shallow water areas, or in areas where you suspect underwater obstacles may exist which could be struck by the outboard or the boat bottom. **The most important thing you can do to help reduce injury or impact damage from striking a floating or underwater object is to control the boat speed. Under these conditions, boat speed should be kept to a minimum planing speed 24 to 40 km/h (15 to 25 MPH).**

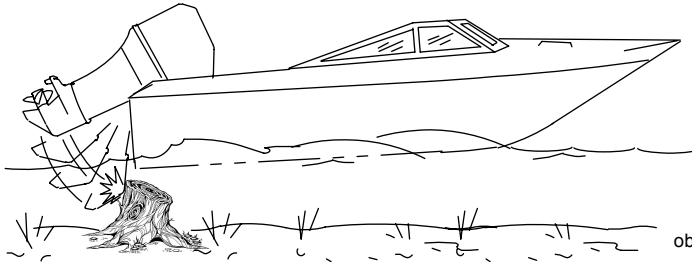

ob00315

## WARNING

**To avoid serious injury or death from all or part of an outboard coming into the boat after striking a floating or underwater obstacle maintain a top speed no greater than minimum planing speed.**

Striking a floating or underwater object could result in an infinite number of situations. Some of these situations could result in the following:

- Part of the outboard or the entire outboard could break loose and fly into the boat.

# GENERAL INFORMATION

- The boat could move suddenly in a new direction. Such a sharp change in direction can cause occupants to be thrown out of their seats or out of the boat.
- A rapid reduction in speed. This will cause occupants to be thrown forward, or even out of the boat.
- Impact damage to the outboard and/or boat.

Keep in mind, the most important thing you can do to help reduce injury or impact damage during an impact is control the boat speed. Boat speed should be kept to a minimum planing speed when driving in waters known to have underwater obstacles.

After striking a submerged object, stop the engine as soon as possible and inspect it for any broken or loose parts. If damage is present or suspected, the outboard should be taken to an authorized dealer for a thorough inspection and necessary repair.

The boat should also be checked for any hull fractures, transom fractures, or water leaks.

Operating a damaged outboard could cause additional damage to other parts of the outboard, or could affect control of the boat. If continued running is necessary, do so at greatly reduced speeds.

## WARNING

**Avoid serious injury or death from loss of boat control. Continued boating with major impact damage can result in sudden outboard component failure with or without subsequent impacts. Have the outboard thoroughly inspected and any necessary repairs made.**

## Exhaust Emissions

### BE ALERT TO CARBON MONOXIDE POISONING

Carbon monoxide is present in the exhaust fumes of all internal combustion engines. This includes the outboards, sterndrives and inboard engines that propel boats, as well as the generators that power various boat accessories. Carbon monoxide is a deadly gas that is odorless, colorless and tasteless.

Early symptoms of carbon monoxide poisoning which should not be confused with seasickness or intoxication, include headache, dizziness, drowsiness, and nausea.

## WARNING

**Avoid the combination of a running engine and poor ventilation. Prolonged exposure to carbon monoxide in sufficient concentration can lead to unconsciousness, brain damage, or death.**

### GOOD VENTILATION

Ventilate passenger area, open side curtains, or forward hatches to remove fumes.

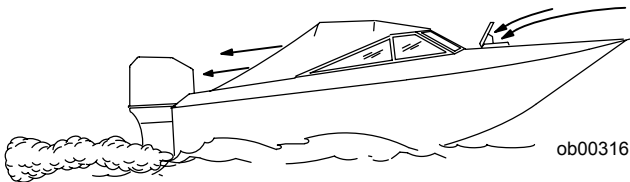

Example of desired air flow through the boat.

### POOR VENTILATION

Under certain running and/or wind conditions, permanently enclosed or canvas enclosed cabins or cockpits with insufficient ventilation may draw in carbon monoxide. Install one or more carbon monoxide detectors in your boat.

Although the occurrence is rare, on a very calm day, swimmers and passengers in an enclosed area of a stationary boat that contains or is near a running engine may be exposed to a hazardous level of carbon monoxide.

# GENERAL INFORMATION

## WHILE BOAT IS STATIONARY

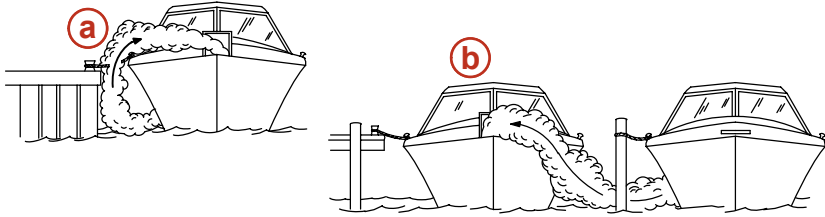

ob00317

**a-** Running the engine when the boat is moored in a confined space.

**b-** Mooring close to another boat that has its engine running.

## WHILE BOAT IS MOVING

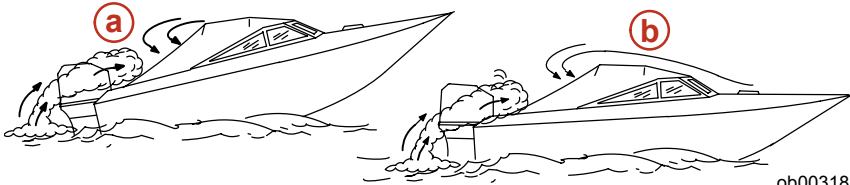

ob00318

**a-** Running the boat with the trim angle of the bow too high.

**b-** Running the boat with no forward hatches open.

## Selecting Accessories For Your Outboard

Genuine Mercury Precision or Quicksilver Accessories have been specifically designed and tested for your outboard. These accessories are available from Mercury Marine dealers.

### **WARNING**

**Check with your dealer before installation of accessories. The misuse of acceptable accessories or the use of unacceptable accessories can result in serious injury, death, or product failure.**

Some accessories not manufactured or sold by Mercury Marine are not designed to be safely used with your outboard or outboard operating system. Acquire and read the installation, operation, and maintenance manuals for all your selected accessories.

## Safe Boating Suggestions

In order to safely enjoy the waterways, familiarize yourself with local and other governmental boating regulations and restrictions, and consider the following suggestions.

**Use flotation devices.** Have an approved personal flotation device of suitable size for each person aboard (it is the law) and have it readily accessible.

**Do not overload your boat.** Most boats are rated and certified for maximum load (weight) capacities (refer to your boat capacity plate). If in doubt, contact your dealer or the boats manufacturer.

**Perform safety checks and required maintenance.** Follow a regular schedule and ensure that all repairs are properly made.

# GENERAL INFORMATION

**Know and obey all nautical rules and laws of the waterways.** Boat operators should complete a boating safety course. Courses are offered in the U.S.A. by 1) The U.S. Coast Guard Auxiliary, 2) The Power Squadron, 3) The Red Cross and 4) your state boating law enforcement agency. Inquiries may be made to the Boating Hotline, 1-800-368-5647 or the Boat U.S. Foundation information number 1-800-336-BOAT.

**Make sure everyone in the boat is properly seated.** Do not allow anyone to sit or ride on any part of the boat that was not intended for such use. This includes the back of seats, gunwales, transom, bow, decks, raised fishing seats, any rotating fishing seat; or anywhere that an unexpected acceleration, sudden stopping, unexpected loss of boat control, or sudden boat movement could cause a person to be thrown overboard or into the boat.

**Never be under the influence of alcohol or drugs while boating (it is the law).** Alcohol or drug use impairs your judgment and greatly reduces your ability to react quickly.

**Prepare other boat operators.** Instruct at least one other person on board in the basics of starting and operating the outboard, and boat handling, in case the driver becomes disabled or falls overboard.

**Passenger boarding.** Stop the engine whenever passengers are boarding, unloading, or are near the back (stern) of the boat. Just shifting the outboard into neutral is not sufficient.

**Be alert.** The operator of the boat is responsible by law to maintain a proper lookout by sight and hearing. The operator must have an unobstructed view particularly to the front. No passengers, load, or fishing seats should block the operators view when operating the boat above idle speed.

**Never drive your boat directly behind a water skier in case the skier falls.** As an example, your boat traveling at 40 km/h (25 MPH) will overtake a fallen skier 61 m (200 ft.) in front of you in 5 seconds.

**Watch fallen skiers.** When using your boat for water skiing or similar activities, always keep a fallen or down skier on the operator's side of the boat while returning to assist the skier. The operator should always have the down skier in sight and never back up to the skier or anyone in the water.

**Report accidents.** Boat operators are required by law to file a Boating Accident Report with their state boating law enforcement agency when their boat is involved in certain boating accidents. A boating accident must be reported if 1) there is loss of life or probable loss of life, 2) there is personal injury requiring medical treatment beyond first aid, 3) there is damage to boats or other property where the damage value exceeds \$500.00 or 4) there is complete loss of the boat. Seek further assistance from local law enforcement.

## Recording Serial Number

It is important to record this number for future reference. The serial number is located on the outboard as shown.

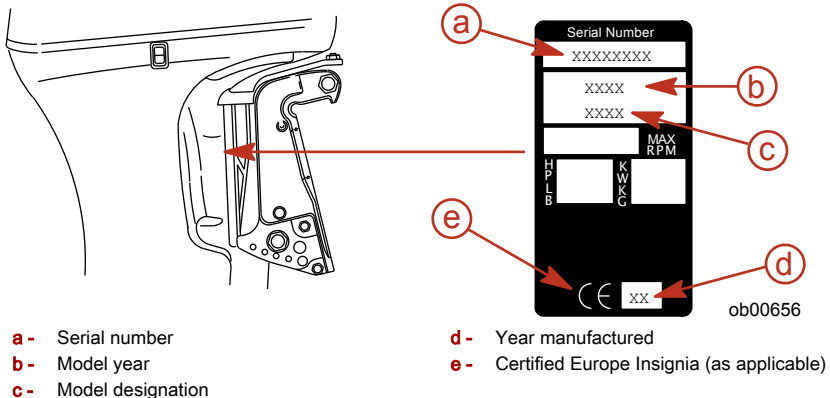

## 200/225 OptiMax DTS Specifications

Models	200	225
Horsepower	200	225

## GENERAL INFORMATION

Models	200	225
Kilowatts	149	168
Full Throttle RPM Range	5000-5750	
Idle Speed in Forward Gear	575 ± 25 RPM	
Number of Cylinders	6	
Piston Displacement	3048 cc (186 cu. in.)	
Cylinder Bore	92.1 mm (3.626 in.)	
Piston Stroke	76.2 mm (3.000 in.)	
Recommended Spark Plug	NGK IZFR5G	
Spark Plug Gap	0.8 mm (0.031 in.)	
Standard Gearcase Ratio	1.75:1	
High Altitude Gearcase Ratio	1.87:1	
Recommended Gasoline	Refer to <b>Fuel &amp; Oil</b>	
Recommended Oil	Refer to <b>Fuel &amp; Oil</b>	
Gearcase Lubricant Capacity	798 ml (27 fl. oz.)	
Battery Rating	1000 Marine Cranking Amps (MCA) or 800 Cold Cranking Amps (CCA)	
Charging System Output	60 Amps	

# GENERAL INFORMATION

## Component Identification

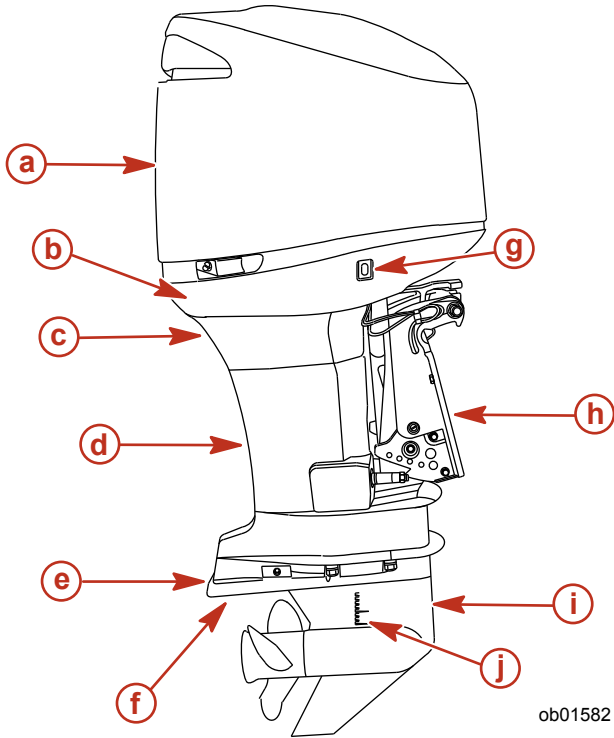

- a-** Top cowl
- b-** Bottom cowl
- c-** Water pump indicator hole
- d-** Driveshaft housing
- e-** Anti-ventilation plate

- f-** Anode plate
- g-** Auxiliary tilt switch
- h-** Transom brackets
- i-** Gearcase
- j-** Cooling water intake holes

# INSTALLATION

## Installing Outboard

### WARNING

Before operation, the outboard must be correctly installed with the required mounting hardware as shown. Failure to correctly fasten outboard could result in outboard ejecting off boat transom causing serious injury, death, or property damage.

We strongly recommend that your dealer install your outboard and related accessories to ensure proper installation and good performance. If you install the outboard yourself, follow instructions in the Outboard Installation Manual which is provided with the outboard.

The outboard must be secured to the transom with the four 12.7 mm (1/2 in.) diameter mounting bolts and locknuts provided. Install two bolts through the upper set of holes and two bolts through the lower set of holes.

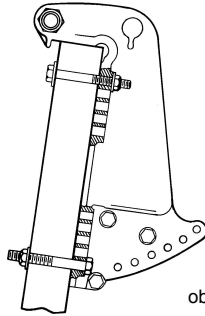

ob00658

## MAXIMUM OUTBOARD MOUNTING HEIGHT

The mounting height of the outboard must not exceed 635 mm (25 in.) for EL models, 762 mm (30 in.) for EXL models, and 889 mm (35 in.) for EXXL models. Mounting the outboard higher may cause damage to the gearcase components.

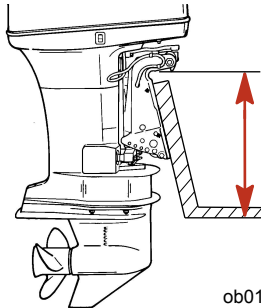

ob01523

## Propeller Selection

For best all around performance from your outboard/boat combination, select a propeller that allows the engine to operate in the upper half of the recommended full throttle RPM range with the boat normally loaded (refer to **General Information - Specifications**). This RPM range allows for better acceleration while maintaining maximum boat speed.

## INSTALLATION

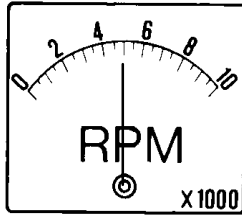

ob00323

If changing conditions cause the RPM to drop below the recommended range, such as warmer, more humid weather, operation at higher elevations, increased boat load, or a dirty boat bottom/gearcase, a propeller change or cleaning may be required to maintain performance and ensure the outboards durability.

Check full-throttle RPM, using an accurate tachometer, with the engine trimmed out to a balanced-steering condition (steering effort equal in both directions) without causing the propeller to break loose.



# TRANSPORTING

## Trailing Boat/Outboard

Trailer your boat with the outboard tilted down in a vertical operating position.

If additional ground clearance is required, the outboard should be tilted up using an accessory outboard support device. Refer to your local dealer for recommendations. Additional clearance may be required for railroad crossings, driveways and trailer bouncing.

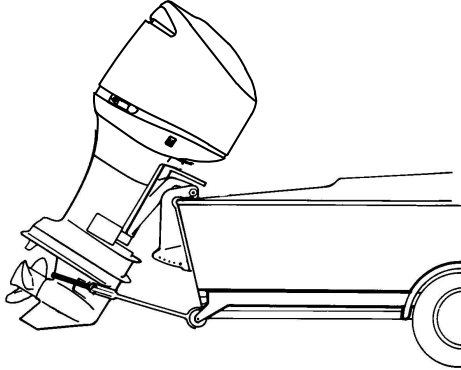

or26

**IMPORTANT:** Do not rely on the power trim/tilt system or tilt support lever to maintain proper ground clearance for trailing. The outboard tilt support lever is not intended to support the outboard for trailing.

# FUEL AND OIL

## Fuel Recommendations

**IMPORTANT:** Use of improper gasoline can damage your engine. Engine damage resulting from the use of improper gasoline is considered misuse of the engine, and damage caused thereby will not be covered under the limited warranty.

## FUEL RATINGS

Mercury Marine engines will operate satisfactorily when using a major brand of unleaded gasoline meeting the following specifications:

**USA and Canada** - having a posted pump Octane Rating of 87 (R+M)/2 minimum. Premium gasoline [92 (R+M)/2 Octane] is also acceptable. Do NOT use leaded gasoline.

**Outside USA and Canada** - having a posted pump Octane Rating of 90 RON minimum. Premium gasoline (98 RON) is also acceptable. If unleaded gasoline is not available, use a major brand of leaded gasoline.

## USING REFORMULATED (OXYGENATED) GASOLINES (USA ONLY)

This type of gasoline is required in certain areas of the USA. The 2 types of oxygenates used in these fuels are Alcohol (Ethanol) or Ether (MTBE or ETBE). If Ethanol is the oxygenate that is used in the gasoline in your area, refer to Gasolines Containing Alcohol.

These Reformulated Gasolines are acceptable for use in your Mercury Marine engine.

## GASOLINES CONTAINING ALCOHOL

If the gasoline in your area contains either methanol (methyl alcohol) or ethanol (ethyl alcohol), you should be aware of certain adverse effects that can occur. These adverse effects are more severe with methanol. Increasing the percentage of alcohol in the fuel can also worsen these adverse effects.

Some of these adverse effects are caused because the alcohol in the gasoline can absorb moisture from the air, resulting in a separation of the water/alcohol from the gasoline in the fuel tank.

The fuel system components on your Mercury Marine engine will withstand up to 10% alcohol content in the gasoline. We do not know what percentage your boat's fuel system will withstand. Contact your boat manufacturer for specific recommendations on the boat's fuel system components (fuel tanks, fuel lines, and fittings). Be aware that gasolines containing alcohol may cause increased:

- Corrosion of metal parts
- Deterioration of rubber or plastic parts
- Fuel permeation through rubber fuel lines
- Starting and operating difficulties

## WARNING

**FIRE AND EXPLOSION HAZARD:** Fuel leakage from any part of the fuel system can be a fire and explosion hazard which can cause serious bodily injury or death. Careful periodic inspection of entire fuel system is mandatory, particularly after storage. All fuel components should be inspected for leakage, softening, hardening, swelling or corrosion. Any sign of leakage or deterioration requires replacement before further engine operation.

Because of possible adverse effects of alcohol in gasoline, it is recommended that only alcohol-free gasoline be used where possible. If only fuel containing alcohol is available, or if the presence of alcohol is unknown, increased inspection frequency for leaks and abnormalities is required.

**IMPORTANT:** When operating a Mercury Marine engine on gasoline containing alcohol, storage of gasoline in the fuel tank for long periods should be avoided. Long periods of storage, common to boats, create unique problems. In cars, alcohol-blend fuels normally are consumed before they can absorb enough moisture to cause trouble, but boats often sit idle long enough for phase separation to take place. In addition, internal corrosion may take place during storage if alcohol has washed protective oil films from internal components.

## Fuel Additives

To minimize carbon deposit buildup in the engine, it is recommended to add Mercury or Quicksilver Quicklean Engine Treatment additive to the engine's fuel at each tank fill throughout the boating season. Use additive as directed on container.

# FUEL AND OIL

## Fuel Requirements

Do not use pre-mixed gas and oil in this engine. The engine automatically receives extra oil during engine break-in. Use a fresh supply of the recommended gasoline during engine break-in and after engine break-in.

## Avoiding Fuel Flow Restriction

**IMPORTANT:** Adding components to the fuel supply system (filters, valves, fittings, etc.) may restrict the fuel flow. This may cause engine stalling at low speed, and/or a lean fuel condition at high RPM that could cause engine damage.

## Filling Fuel Tank

### **WARNING**

**Avoid serious injury or death from a gasoline fire or explosion. Always stop the engine and do not smoke or allow open flames or sparks in the area while filling fuel tanks.**

Fill fuel tanks outdoors away from heat, sparks, and open flames.

Remove portable fuel tanks from boat to refill them.

Always stop engine before refilling tanks.

Do not completely fill the fuel tanks. Leave approximately 10% of the tank volume unfilled. Fuel will expand in volume as its temperature rises and can leak under pressure if the tank is completely filled.

## Oil Recommendation

<b>Recommended Oil</b>	<b>MercuryOptimax/DFI or Quicksilver DFI 2-Cycle Engine Oil</b>
------------------------	---

Mercury Optimax/DFI or Quicksilver DFI 2-Cycle Engine Oil is recommended for your engine. If Mercury Optimax/DFI or Quicksilver DFI 2-Cycle engine oil is not available, we recommend using Mercury or Quicksilver TC-W3 Premium Plus 2-Cycle Oil. Severe engine damage may result from use of an inferior oil.

## Filling Remote Oil Tank

Remove filler cap and fill with the specified oil. Oil tank capacity is 11.5 liters (3 gallons). Replace filler cap and tighten securely.

**IMPORTANT:** Always make sure the oil tank caps are threaded on tight. An air leak will prevent oil flow to the engine.

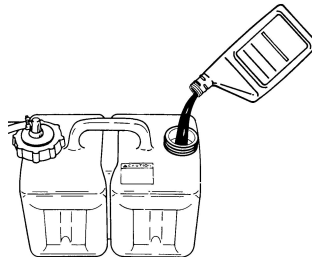

or27

## Filling Engine Mounted Oil Reservoir Tank

**NOTE:** Filling this tank is only necessary if the oil level should ever drop and the low oil warning system is activated.

1. Remove the top cowl.

# FUEL AND OIL

2. Loosen the fill cap on the engine oil reservoir tank. Run the engine until all the air has been vented out of the oil reservoir tank and tank is filled with oil to the point of overflow.
3. Re-tighten the fill cap. Stop the engine and replace the top cowl.

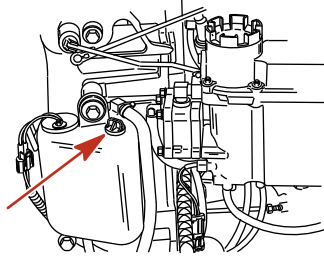

ob01583

# FEATURES AND CONTROLS

## Warning System

The outboard warning system incorporates a warning horn inside the boat. The warning horn is located under the dash within the wiring harness.

### WARNING HORN SIGNALS

When the key switch is turned to the "ON" position, the horn will turn on for a moment as a test to show the horn is working.

The warning horn will emit either a continuous beep or intermittent short beeps. This will alert the operator and help identify the following listed situations. For visual display of the specific engine functions and for additional engine data, refer to **SmartCraft Product** information, following.

Warning Horn		
Function	Sound	Description
Start up	One beep	Normal system test
Low oil reserve	Four beeps every 2 minutes	Oil lever is low in the engine mounted oil reservoir. Refill the engine mounted oil reservoir along with the remote oil tank. Refer to <b>Fuel &amp; Oil</b> .
Water in fuel	Four beeps every 2 minutes	Water in the fuel filter chamber reaches the full level. Water can be removed from the chamber. Refer to <b>Maintenance - Fuel System</b> for water removal.
Cooling system problem	Continuous	Engine Guardian System is activated. Power limit will vary with level of overheat. Shift outboard into neutral and check for a steady stream of water coming out of the water pump indicator hole. If no water is coming out of the water pump indicator hole or flow is intermittent, stop engine and check water intake holes for obstruction.

## FEATURES AND CONTROLS

Warning Horn		
Function	Sound	Description
Oil level is critically low	Continuous	Engine Guardian System is activated. Power will be limited. The oil level is critically low in the engine mounted oil reservoir. Refill the engine mounted oil reservoir along with the remote oil tank. Refer to <b>Fuel &amp; Oil</b> .
Oil pump failure	Continuous	Engine Guardian System is activated. Power limit will allow a fast idle. The warning horn is activated if the oil pump should ever stop functioning electrically. No lubricating oil is being supplied to the engine.
Engine overspeed	Continuous	The warning horn is activated any time engine speed exceeds the maximum allowable RPM. The system will limit the engine speed to within the allowable range. Engine overspeed indicates a condition that should be corrected. Overspeed could be caused by incorrect propeller pitch, engine height, trim angle, etc.
Remote control failure	Continuous	Engine Guardian System is activated. Wiring problem to the remote control or an internal control problem has occurred.
Sensor out of range	Continuous	Engine Guardian System is activated. Power limit may activate at full throttle speed.
	Intermittent beep	Engine Guardian System is activated. Power limit may restrict engine speed to idle.

# FEATURES AND CONTROLS

Warning Horn		
Function	Sound	Description
Engine running cold at slow speed	One beep	Engine is not reaching correct temperature while operating below 1000 RPM.

## ENGINE GUARDIAN SYSTEM

The Engine Guardian System monitors the critical sensors on the engine for any early indications of problems. The system will respond to a problem by emitting a continuous beep and/or reducing engine power in order to provide engine protection.

If Guardian System has been activated, reduce throttle speed. The problem will need to be identified and corrected, if possible. The system must be reset before the engine will operate at higher speeds. Moving the throttle lever back to the idle position will reset the system.

## SMARTCRAFT PRODUCT

A Mercury SmartCraft System instrument package can be purchased for this outboard. A few of the functions the instrument package will display are engine RPM, coolant temperature, battery voltage, fuel consumption and engine operating hours.

The SmartCraft Instrument package will also aid in Engine Guardian diagnostics. The SmartCraft Instrument package will display critical engine alarm data and potential problems.

## Remote Control Features

### PANEL MOUNT FEATURES

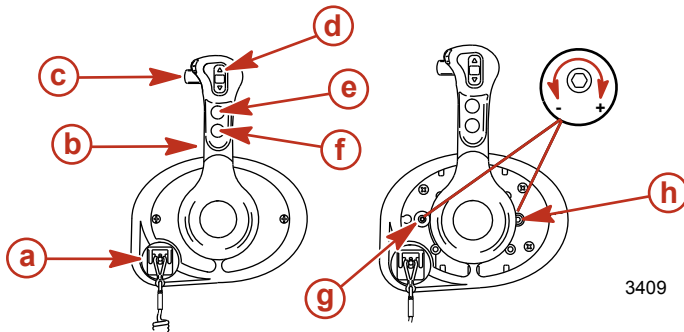

3409

- a** - Lanyard/lanyard stop switch - Refer to **General Information - Lanyard Stop Switch**.
- b** - Control handle - Forward (F), Neutral (N), Reverse (R).
- c** - Shift lock - Refer to **Operation - Gear Shifting**.
- d** - Trim/tilt switch - Refer to **Power Trim and Tilt**.
- e** - Throttle only button - Allows the boat operator to increase engine RPM for warm-up, without shifting the engine into gear.
- f** - Stop/start button - Allows the boat operator to start or stop the engine without using the ignition key.
- g** - Detent tension adjustment - Refer to **Operation - Remote Control Adjustments**.
- h** - Control handle friction adjustment screw - Refer to **Operation - Remote Control Adjustments**.

# FEATURES AND CONTROLS

## CONSOLE MOUNT FEATURES - SINGLE ENGINE

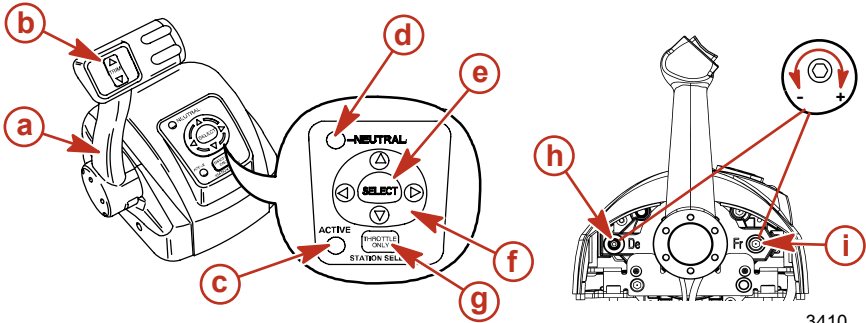

3410

- a** - Control handle - Forward (F), Neutral (N), Reverse (R).
- b** - Trim/tilt switch - Refer to **Power Trim and Tilt**.
- c** - Active light - Illuminated when remote control is active and ready.
- d** - Neutral light - Illuminated when engine is in neutral gear position. Blinks when engine is in throttle only mode.
- e** - Select key - Used to select System View on-screen options, if equipped. Refer to **System View Operation Manual** for screen options.
- f** - Arrow trackpad - Used to scroll through System View displays, if equipped. Refer to **System View Operation Manual** for screen options.
- g** - Throttle only/station select key - Allows the boat operator to increase engine RPM for warm-up, without shifting the engine into gear. Allows the boat operator to select which station will be used for dual helm applications. Refer to **Operation - Starting The Engine**.
- h** - Detent tension adjustment - Refer to **Operation - Remote Control Adjustments**.
- i** - Control handle friction adjustment screw - Refer to **Operation - Remote Control Adjustments**.



# FEATURES AND CONTROLS

## CONSOLE MOUNT FEATURES - DUAL ENGINE

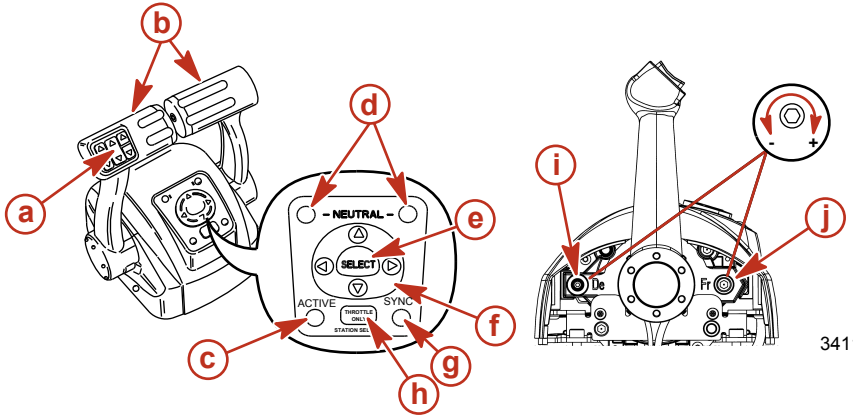

3411

- a - Trim/tilt switch - Refer to **Power Trim and Tilt**.
- b - Control handles - Forward (F), Neutral (N), Reverse (R).
- c - Active light - Illuminated when remote control is active and ready to use.
- d - Neutral light - Illuminated when engine is in neutral gear position. Blinks when engine is in throttle only mode.
- e - Select key - Used to select System View on-screen options, if equipped. Refer to **System View Operation Manual** for screen options.
- f - Arrow trackpad - Used to scroll through System View displays, if equipped. Refer to **System View Operation Manual** for screen options.
- g - Sync light - Illuminated when the auto synchronizing feature is engaged. Refer to **Operation - Starting The Engine**.
- h - Throttle only/station select key - Allows the boat operator to increase engine RPM for warm-up, without shifting the engine into gear. Allows the boat operator to select which station will be used for dual helm applications. Refer to **Operation - Starting The Engine**.
- i - Detent tension adjustment - Refer to **Operation - Remote Control Adjustments**.
- j - Control handle friction adjustment screw - Refer to **Operation - Remote Control Adjustments**.

# FEATURES AND CONTROLS

## SLIM BINNACLE CONSOLE MOUNT FEATURES - SINGLE ENGINE

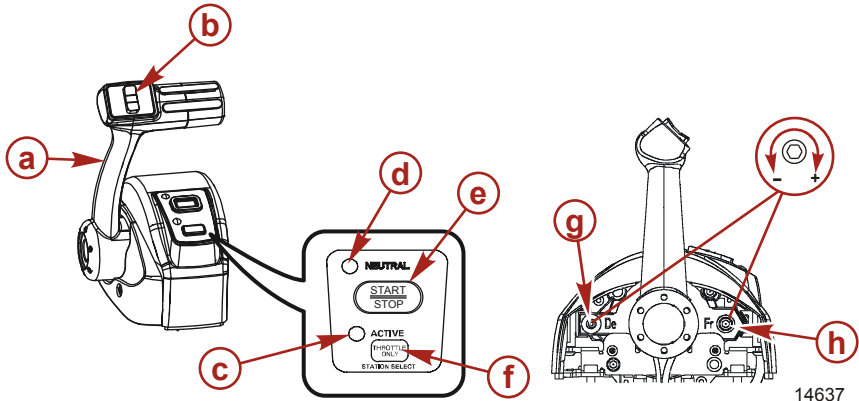

- a -** Control handle - Forward (F), Neutral (N), Reverse (R).
- b -** Trim/tilt switch - Refer to **Power Trim and Tilt**.
- c -** Active light - Illuminated when remote control is active and ready.
- d -** Neutral light - Illuminated when engine is in neutral gear position. Blinks when engine is in throttle only mode.
- e -** Start/stop button - Allows the boat operator to start or stop the engine without using the ignition key.
- f -** Throttle only/station select key - Allows the boat operator to increase engine RPM for warm-up, without shifting the engine into gear. Allows the boat operator to select which station will be used for dual helm applications. Refer to **Operation - Starting The Engine**.
- g -** Detent tension adjustment - Refer to **Operation - Remote Control Adjustments**.
- h -** Control handle friction adjustment screw - Refer to **Operation - Remote Control Adjustments**.

# FEATURES AND CONTROLS

## SHADOW MODE REMOTE CONTROL FEATURES

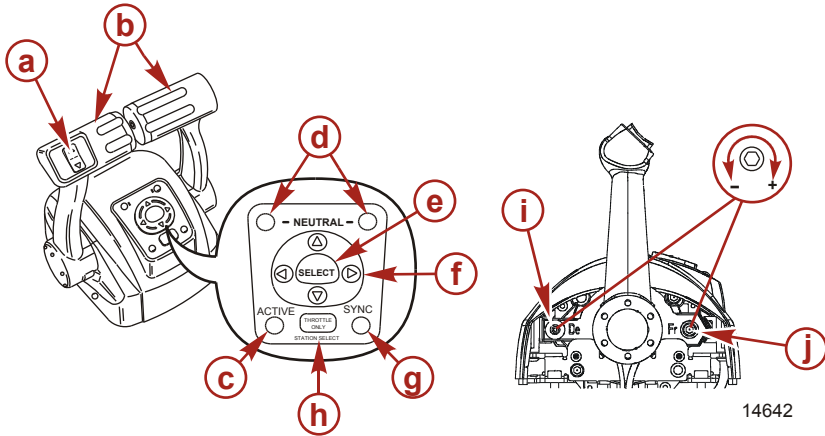

- a** - Trim/tilt switch - Refer to **Power Trim and Tilt**.
- b** - Control handle - Forward (F), Neutral (N), Reverse (R).
- c** - Active light - Illuminated when remote control is active and ready.
- d** - Neutral light - Illuminated when engine is in neutral gear position. Blinks when engine is in throttle only mode.
- e** - Select key - Used to select System View on-screen options, if equipped. Refer to **System View Operation Manual** for screen options.
- f** - Arrow trackpad - Used to scroll through System View displays, if equipped. Refer to **System View Operation Manual** for screen options.
- g** - Sync light - Illuminated when the auto synchronizing feature is engaged. Refer to **Operation - Starting The Engine**.
- h** - Throttle only/station select key - Allows the boat operator to increase engine RPM for warm-up, without shifting the engine into gear. Allows the boat operator to select which station will be used for dual helm applications. Refer to **Operation - Starting The Engine**.
- i** - Detent tension adjustment - Refer to **Operation - Remote Control Adjustments**.
- j** - Control handle friction adjustment screw - Refer to **Operation - Remote Control Adjustments**.

### Throttle and Shift Operation

Movement of the handles on the remote control allows the boat operator to control the engine throttle speed and gear shift positions of all three engines.

The throttle and shift function is dependant on what engines are running. Refer to the following table.

## FEATURES AND CONTROLS

Port Engine	Center Engine	Starboard Engine	Control Handle Function
Running	Running	Running	Port engine throttle and shift = controlled by port control handle
			Starboard engine throttle and shift = controlled by starboard control handle
			Center engine throttle = average of port and starboard engines
			Center engine shift = neutral unless both engines are in the same gear
Running	Running	Off	Port and center engine throttle and shift = controlled by port control handle
Off	Running	Running	Starboard and center engine throttle and shift = controlled by starboard control handle
Running	Off	Running	Port engine throttle and shift = controlled by port control handle
			Starboard engine throttle and shift = controlled by starboard control handle
Running	Off	Off	Port engine throttle and shift = controlled by port control handle
Off	Off	Running	Starboard engine throttle and shift = controlled by starboard control handle

# FEATURES AND CONTROLS

Port Engine	Center Engine	Starboard Engine	Control Handle Function
Off (ignition key switch turned on)	Running	Off (ignition key switch turned on)	Center engine throttle and shift = neutral/idle unless both control handles are in the same gear

Turning off one of the outer engines while underway will cause the center engine to go into forced neutral/idle. Operation to the center engine can be restored by moving the control handle of the functioning outer engine back into neutral position and then re-engaging. The center engine speed and gear shift will then be controlled by the functioning outer engine.

Turning off the center engine while underway will have no effect on the operation of the outer engines.

If a failure should occur while underway which causes a one of the outer engines into forced neutral/idle condition, the center engine will also be forced to neutral/idle. Operation to the center engine can be restored by moving the control handle of the functioning outer engine back into neutral and then re-engaging.

Operation of the shift and throttle is controlled by the movement of the control handles. Push the control handles forward from the neutral to the first detent for forward gear. Continue pushing the control handles forward to increase speed. Pull the control handles back from neutral to the first detent for reverse gear. Continue pulling back to increase speed

## Power Trim and Tilt

The outboard has a trim/tilt control called power trim. This enables the operator to easily adjust the position of the outboard by pressing the trim switch. Moving the outboard in closer to the boat transom is called trimming in or down. Moving the outboard further away from the boat transom is called trimming out or up. The term trim generally refers to the adjustment of the outboard within the first 20° range of travel. This is the range used while operating the boat on plane. The term tilt is generally used when referring to adjusting the outboard further up out of the water. With the engine turned off and ignition switch turned on, the outboard can be tilted out of the water. At low idle speed, the outboard can also be tilted up past the trim range to permit, for example, shallow water operation.

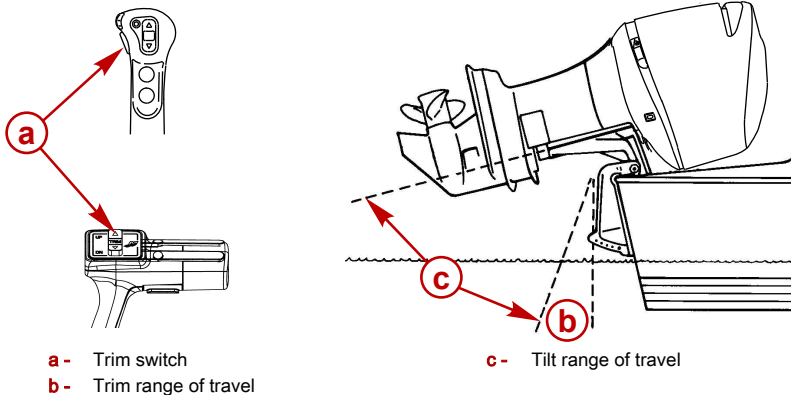

3327

## POWER TRIM OPERATION

With most boats, operating around the middle of the trim range will give satisfactory results. However, to take full advantage of the trimming capability there may be times when you choose to trim your outboard all the way in or out. Along with an improvement in some performance aspects comes a greater responsibility for the operator, and this is being aware of some potential control hazards.

# FEATURES AND CONTROLS

The most significant control hazard is a pull or torque that can be felt on the steering wheel or tiller handle. This steering torque results from the outboard being trimmed so that the propeller shaft is not parallel to the water surface.

## WARNING

**Avoid possible serious injury or death. When the outboard is trimmed in or out beyond a neutral steering condition, a pull on the steering wheel or tiller handle in either direction may result. Failure to keep a continuous firm grip on the steering wheel or tiller handle when this condition exists can result in loss of boat control as the outboard can turn freely. The boat can now spin out or go into a very tight maximum turn which, if unexpected, can result in occupants being thrown within the boat or out of the boat.**

Consider the following lists carefully.

1. Trimming In or Down Can:
  - Lower the bow.
  - Result in quicker planing off, especially with a heavy load or a stern heavy boat.
  - Generally improve the ride in choppy water.
  - Increase steering torque or pull to the right (with the normal right hand rotation propeller).
  - In excess can lower the bow of some boats to a point where they begin to plow with their bow in the water while on plane. This can result in an unexpected turn in either direction (called bow steering or over-steering) if any turn is attempted, or if a significant wave is encountered.

## WARNING

**Avoid possible serious injury or death. Adjust outboard to an intermediate trim position as soon as boat is on plane to avoid possible ejection due to boat spin out. Do not attempt to turn boat when on plane if outboard is trimmed extremely in or down and there is a pull on the steering wheel or tiller handle.**

- In rare circumstances, the owner may decide to limit the trim in. This can be accomplished by purchasing a stainless steel tilt pin from your dealer and inserting it in whatever adjustment hole in the transom brackets is desired. The non-stainless steel shipping bolt should not be used in this application other than on a temporary basis.
2. Trimming Out or Up can:
    - Lift the bow higher out of the water.
    - Generally increase top speed.
    - Increase clearance over submerged objects or a shallow bottom.
    - Increase steering torque or pull to the left at a normal installation height (with the normal right hand rotation propeller).
    - In excess can cause boat porpoising (bouncing) or propeller ventilation.
    - Cause engine overheating if any cooling water intake holes are above the water line.

## TILTING TO FULL UP POSITION

### Tilt At Helm

**NOTE:** *The trim/tilt switch will remain active for 15 minutes after the ignition key switch has been turned off.*

1. If the ignition key switch has been turned off for over 15 minutes, turn it to the "ON" position.
2. Press the trim/tilt switch to the up position. The outboard will tilt up until the switch is released or it reaches its maximum tilt position.

### Tilt At Engine

The cowl mounted auxiliary tilt switch can be used to tilt the outboard with the key switch in the "OFF" position.

1. Engage the tilt support lever, by rotating knob to bring the support lever upward.
2. Lower outboard to rest on the tilt support lever.

# FEATURES AND CONTROLS

3. Disengage the tilt support lever, by raising the outboard off the support lever and rotating the tilt support lever down. Lower the outboard.

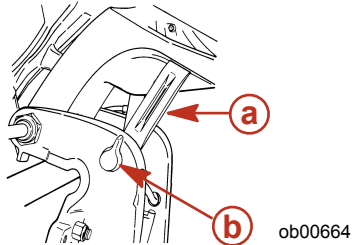

**a** - Tilt support lever

**b** - Knob

## MANUAL TILTING

If the outboard cannot be tilted using the power trim/tilt switch, the outboard can be manually tilted.

**NOTE:** The manual tilt release valve must be tightened before operating the outboard to prevent the outboard from tilting up during reverse operation.

1. Turn out the manual tilt release valve 3 turns counterclockwise. This allows manual tilting of the outboard. Tilt the outboard to the desired position and tighten the manual tilt release valve.

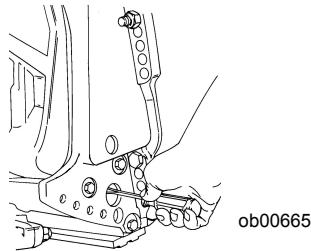

## AUXILIARY TILT SWITCH

This switch can be used to tilt the outboard up or down using the power trim system.

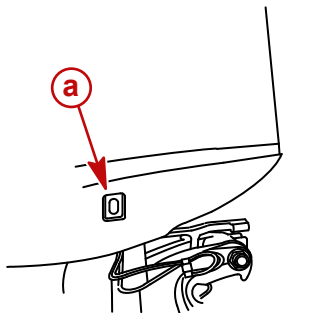

**a** - Auxiliary tilt switch

# FEATURES AND CONTROLS

## SHALLOW WATER OPERATION

When operating your boat in shallow water, you can tilt the outboard beyond the maximum trim range to prevent hitting bottom.

1. Reduce engine speed below 2000 RPM.
2. Tilt outboard up. Make sure all the water intake holes stay submerged at all times.
3. Operate the engine at slow speed only. If engine speed exceeds 2000 RPM, the outboard will automatically return down to the maximum trim range.



# OPERATION

## Pre-Starting Check List

- Operator knows safe navigation, boating, and operating procedures.
- An approved personal flotation device of suitable size for each person aboard and readily accessible (it is the law).
- A ring type life buoy or buoyant cushion designed to be thrown to a person in the water.
- Know the boat's maximum load capacity. Look at the boat capacity plate.
- Fuel supply OK.
- Oil supply (oil injection) OK.
- Arrange passengers and load in the boat so the weight is distributed evenly and everyone is seated in a proper seat.
- Tell someone where you are going and when you expect to return.
- It is illegal to operate a boat while under the influence of alcohol or drugs.
- Know the waters and area you will be boating; tides, currents, sand bars, rocks, and other hazards.
- Make inspection checks listed in **Maintenance - Inspection and Maintenance Schedule**.

## Operating In Freezing Temperatures

When using your outboard or having your outboard moored in freezing or near freezing temperatures, keep the outboard tilted down at all times so the gearcase is submerged. This prevents trapped water in gearcase from freezing and causing possible damage to the water pump and other components.

If there is a chance of ice forming on the water, the outboard should be removed and drained completely of water. If ice should form at the water level inside the outboard driveshaft housing, it will block water flow to the engine causing possible damage.

## Operating In Salt Water Or Polluted Water

We recommend that you flush the internal water passages of your outboard with fresh water after each use in salt or polluted water. This will prevent a buildup of deposits from clogging the water passages. Refer to **Maintenance - Flushing The Cooling System**.

If you keep your boat moored in the water, always tilt the outboard so the gearcase is completely out of water (except in freezing temperatures) when not in use.

Wash the outboard exterior and flush out the exhaust outlet of the propeller and gearcase with fresh water after each use. Each month, spray Mercury Precision or Quicksilver Corrosion Guard on external metal surfaces. Do not spray on corrosion control anodes as this will reduce the effectiveness of the anodes.

## Operating at High Elevations

Your engine automatically compensates for high elevation changes. A different pitch propeller may help reduce some normal performance loss resulting from reduced oxygen in the air. Consult your dealer.

## Setting Trim Angle While Running Engine at Idle Speed

Submerging the exhaust relief hole on the outboard can happen on some boats if you trim full in while running at idle speed, resulting in, exhaust restriction, rough idle, excessive smoke, and fouled spark plugs. If this condition exists, trim outboard up until exhaust relief hole is out of the water.

# OPERATION

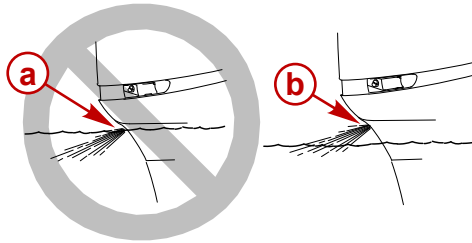

or35-1

a - Relief hole submerged (wrong)

b - Relief hole above water line (correct)

## Engine Break-in Procedure

### ⚠ CAUTION

Severe damage to the engine can result by not complying with the Engine Break-in Procedure.

## GASOLINE/OIL BREAK-IN MIXTURE

**NOTE:** Do not use pre-mixed gas and oil during break-in. Use straight gasoline during engine break-in and after engine break-in.

The engine break-in procedure for an OptiMax outboard is important to ensure proper performance and maximum life from the engine. The following break-in procedure allows the internal engine parts to wear-in evenly. Incorrect engine break-in can shorten the engine life.

The engine automatically receives extra oil during the first hours of operation. For most boaters this extra oil mode will be complete in about ten hours.

## BREAK-IN PROCEDURE

1. For the first hour of operation, allow the engine to warm up for 30-60 seconds.
  - a. Run the engine at varied throttle settings, the majority of the time between 3000 and 4500 RPM or three-quarter throttle.
  - b. Change engine speed approximately every two minutes, and avoid continuous operation at idle speed for more than ten minutes. Short bursts of full throttle for periods up to ten seconds are acceptable.
  - c. Avoid trimming the outboard out (up) beyond a vertical trim position during operation.

**NOTE:** It is the driver's responsibility to always drive in a safe manner. Improper trim angle of the outboard when driving at speed can be difficult and dangerous. The purpose of specifying trim angle is to help guide the operator in determining how to put the propel load on the engine. They are intended to be guidelines and do not suggest or require unsafe boat operation.

2. For the next three hours of operation, change engine speed every ten minutes.

## Starting The Engine

### PANEL MOUNT - SINGLE ENGINE STARTING PROCEDURE

Before starting, read the Pre-Starting Check List, Special Operating Instructions, and Engine Break-in Procedure in the Operation Section.

### ⚠ CAUTION

Never start or operate your outboard (even momentarily) without water circulating through all the cooling water intake holes in the gearcase to prevent damage to the water pump (running dry) or overheating of the engine.

# OPERATION

1. Lower the outboard to the vertical operating position. Make sure all cooling water intake holes are submerged.

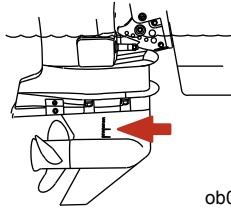

ob00668

2. Open fuel tank vent screw (in filler cap) on manual venting type fuel tanks.

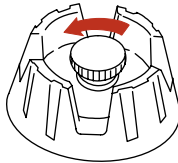

ob00348

3. Squeeze the fuel line primer bulb several times until it feels firm.

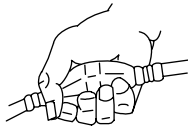

ob00349

**NOTE:** The engine will not start unless the lanyard is set to the "RUN" position.

4. Set the lanyard stop switch to "RUN" position. Refer to **General Information - Lanyard Stop Switch**.



ob00350

5. Shift outboard to neutral (N) position.

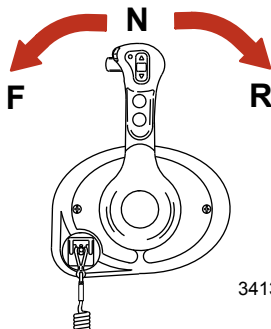

3413

# OPERATION

**NOTE:** The engine can be started by using the ignition key or the start/stop button located on the remote control handle.

6. For initial start of a new engine or for an engine that ran out of fuel, or was drained of fuel, the fuel system should be filled as follows:
  - a. Squeeze the fuel line primer bulb until it feels firm.
  - b. Turn the ignition key switch to the "ON" position for three seconds. This operates the electric fuel pump.
  - c. Turn the ignition key switch back to the "OFF" position, and squeeze the primer bulb again until it feels firm. Turn the ignition key switch to the "ON" position again for three seconds. Continue this procedure until the fuel line primer bulb stays firm.
7. Ignition key starting - Turn the ignition key to "START" position and release the key. The electronic starting system will automatically crank the engine for starting. If engine fails to start, engine will stop cranking. Turn the key to "START" position again until engine starts.

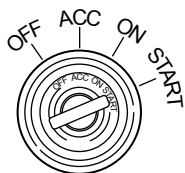

3485

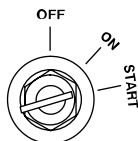

ob00354

8. Start/stop button - Turn the ignition key to "ON" position and press start/stop button and release. The electronic starting system will automatically crank the engine for starting. If the engine fails to start, the engine will stop cranking. Press start/stop button and release again until engine starts.

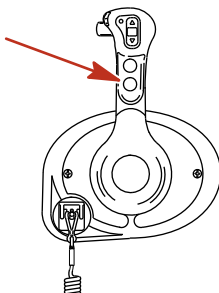

3414

9. Check for a steady stream of water flowing out of the water pump indicator hole.

**IMPORTANT:** If no water is coming out of the water pump indicator hole, stop engine and check cooling water intake holes for obstruction. No obstruction may indicate a water pump failure or blockage in the cooling system. This condition will cause the engine to overheat. Have the outboard checked by your dealer. Operating the engine while overheated will cause engine damage.

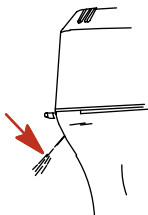

ob00331

## Warming Up Engine

Throttle Only Button - This feature allows the boat operator to increase engine RPM for warm-up, without shifting the engine into gear.

# OPERATION

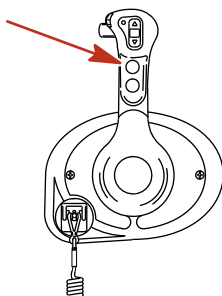

3416

1. Move the control handle into neutral position.
2. Depress shift lock button, press and hold the throttle only button while moving the control handle ahead to the forward detent. The horn sound indicates that throttle only is engaged.
3. Hold in the button until the horn sounds twice. The horn sound indicates that throttle only is engaged.
4. Advance the control handle to increase engine RPM. Engine RPM is limited to 3000 RPM to prevent engine damage.
5. To disengage, return the control handle back to neutral position.

## CONSOLE MOUNT - SINGLE ENGINE STARTING PROCEDURE

Before starting, read the Pre-Starting Check List, Special Operating Instructions, and Engine Break-in Procedure in the Operation Section.

### CAUTION

**Never start or operate your outboard (even momentarily) without water circulating through all the cooling water intake holes in the gearcase to prevent damage to the water pump (running dry) or overheating of the engine.**

1. Lower the outboard to the vertical operating position. Make sure all cooling water intake holes are submerged.

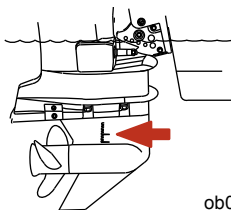

ob00668

2. Open fuel tank vent screw (in filler cap) on manual venting type fuel tanks.

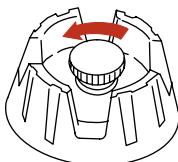

ob00348

3. Squeeze the fuel line primer bulb several times until it feels firm.

# OPERATION

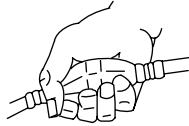

ob00349

**NOTE:** The engine will not start unless the lanyard is set to the "RUN" position.

4. Set the lanyard stop switch to "RUN" position. Refer to **General Information - Lanyard Stop Switch**.



ob00350

5. Shift outboard to neutral (N) position.

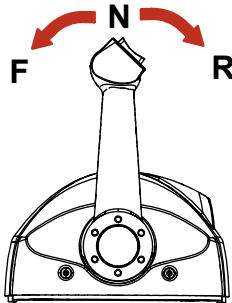

3417

6. For initial start of a new engine or for an engine that ran out of fuel, or was drained of fuel, the fuel system should be filled as follows:
  - a. Squeeze the fuel line primer bulb until it feels firm.
  - b. Turn the ignition key switch to the "ON" position for three seconds. This operates the electric fuel pump.
  - c. Turn the ignition key switch back to the "OFF" position, and squeeze the primer bulb again until it feels firm. Turn the ignition key switch to the "ON" position again for three seconds. Continue this procedure until the fuel line primer bulb stays firm.
7. Turn the ignition key to "START" position and release the key. The electronic starting system will automatically crank the engine for starting. If the engine fails to start, the engine will stop cranking. Return the key to "START" position and try again.

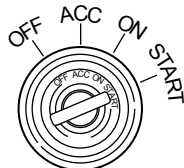

3485

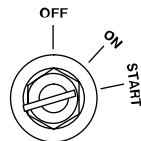

ob00354

8. The "ACTIVE" light located on the console remote control key pad will become illuminated once the engine is started and communicating with the remote control.

# OPERATION

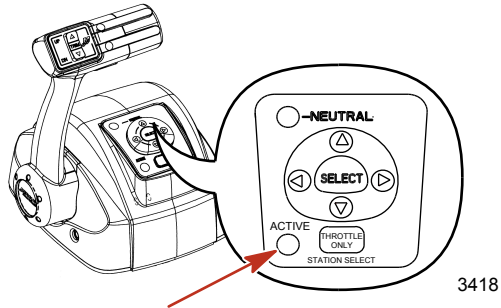

9. Check for a steady stream of water flowing out of the water pump indicator hole.

**IMPORTANT:** If no water is coming out of the water pump indicator hole, stop engine and check cooling water intake holes for obstruction. No obstruction may indicate a water pump failure or blockage in the cooling system. This condition will cause the engine to overheat. Have the outboard checked by your dealer. Operating the engine while overheated will cause engine damage.

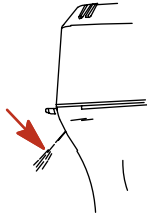

## Warming Up Engine

Throttle Only/Station Select Button - This feature allows the boat operator to increase engine RPM for warm-up, without shifting the engine into gear.

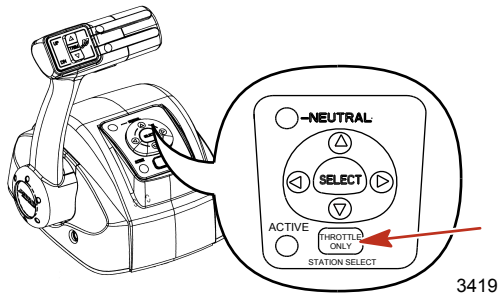

1. Move the control handle into neutral position.
2. Press and hold the throttle only button while moving the control handle ahead to the forward detent.
3. Hold in the button until the horn sounds twice and the neutral light starts flashing. The flashing light indicates that the throttle only is engaged.
4. Advance the control handle to increase engine RPM. Engine RPM is limited to 3000 RPM to prevent engine damage.
5. To disengage, return the control handle back to neutral position.

# OPERATION

## CONSOLE MOUNT - DUAL ENGINE/DUAL HELM STARTING PROCEDURE

Before starting, read the Pre-Starting Check List, Special Operating Instructions, and Engine Break-in Procedure in the Operation Section.

### CAUTION

**Never start or operate your outboard (even momentarily) without water circulating through all the cooling water intake holes in the gearcase to prevent damage to the water pump (running dry) or overheating of the engine.**

1. Lower the outboard to the vertical operating position. Make sure all cooling water intake holes are submerged.

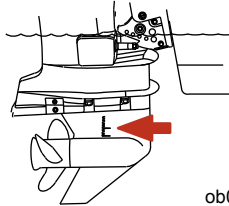

ob00668

2. Open fuel tank vent screw (in filler cap) on manual venting type fuel tanks.

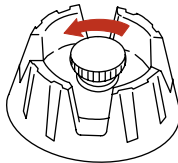

ob00348

3. Squeeze the fuel line primer bulb several times until it feels firm.

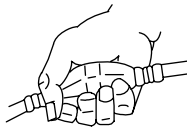

ob00349

**NOTE:** The engine will not start unless the lanyard is set to the "RUN" position.

4. Set the lanyard stop switch to "RUN" position. Refer to **General Information - Lanyard Stop Switch**.



ob00350

5. Shift outboard to neutral (N) position.



# OPERATION

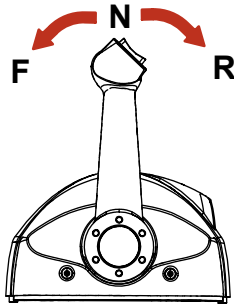

3417

6. For initial start of a new engine or for an engine that ran out of fuel, or was drained of fuel, the fuel system should be filled as follows:
  - a. Squeeze the fuel line primer bulb until it feels firm.
  - b. Turn the ignition key switch to the "ON" position for three seconds. This operates the electric fuel pump.
  - c. Turn the ignition key switch back to the "OFF" position, and squeeze the primer bulb again until it feels firm. Turn the ignition key switch to the "ON" position again for three seconds. Continue this procedure until the fuel line primer bulb stays firm.
7. Turn the ignition key to "START" position and release the key. The electronic starting system will automatically crank the engine for starting. If the engine fails to start, the engine will stop cranking. Return the key to "START" position and try again. Repeat the procedure for the second engine.

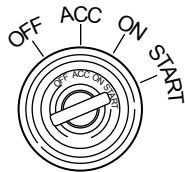

3485

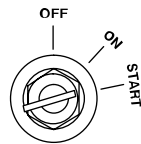

ob00354

8. The "ACTIVE" light located on the console remote control key pad will become illuminated once the engine is started and communicating with the remote control.

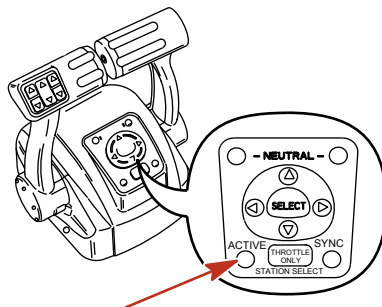

3424

9. Check for a steady stream of water flowing out of the water pump indicator hole.

**IMPORTANT:** If no water is coming out of the water pump indicator hole, stop engine and check cooling water intake holes for obstruction. No obstruction may indicate a water pump failure or blockage in the cooling system. This condition will cause the engine to overheat. Have the outboard checked by your dealer. Operating the engine while overheated will cause engine damage.

# OPERATION

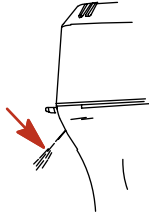

ob00331

## Warming Up Engine

Throttle Only/Station Select Button - This feature allows the boat operator to increase engine RPM for warm-up, without shifting the engines into gear.

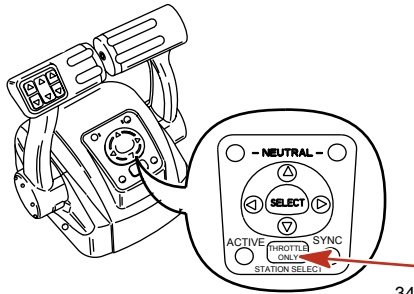

3425

1. Move the control handles into neutral position.
2. Press and hold the throttle only button while moving the control handles ahead to the forward detent.
3. Hold in the button until the horn sounds twice and the neutral lights starts flashing. The flashing lights indicates that the throttle only is engaged.
4. Advance the control handles to increase engine RPM. Engine RPM is limited to 3000 RPM to prevent engine damage.
5. To disengage, return the control handles back to neutral position.

## SLIM BINNACLE - SINGLE ENGINE STARTING PROCEDURE

Before starting, read the Pre-Starting Check List, Special Operating Instructions, and Engine Break-in Procedure in the Operation Section.

### CAUTION

**Never start or operate your outboard (even momentarily) without water circulating through all the cooling water intake holes in the gearcase to prevent damage to the water pump (running dry) or overheating of the engine.**

1. Make sure the cooling water intake is submerged.

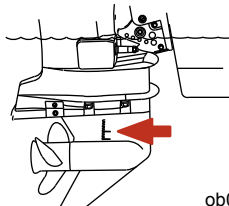

ob00668

# OPERATION

- Open fuel tank vent on manual venting type tanks.

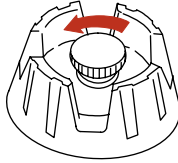

ob00348

**NOTE:** The engine will not start unless the lanyard is set to the "RUN" position.

- Set the lanyard stop switch to the "RUN" position. Refer to **General Information - Lanyard Stop Switch**.



ob00350

- Shift outboard to neutral (N) position.

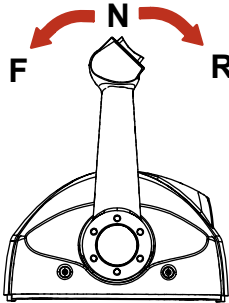

3417

**NOTE:** The engine can be started by using the ignition key or the start/stop button located on the remote control panel.

- Ignition key starting - Turn the ignition key to "START" position and release the key. The electronic starting system will automatically crank the engine for starting. If the engine fails to start, the engine will stop cranking. Turn the key to "START" position again until engine starts.

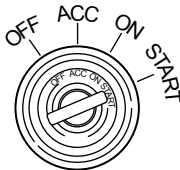

3485

- Start/stop button - Turn the ignition key to "ON" position and press start/stop button and release. The electronic starting system will automatically crank the engine for starting. If the engine fails to start, the engine will stop cranking. Press start/stop button and release again until engine starts.

# OPERATION

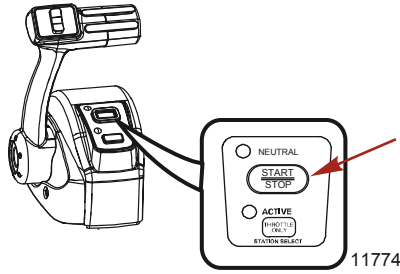

7. The "ACTIVE" light located on the remote control panel will become illuminated once the engine is started and communicating with the remote control.

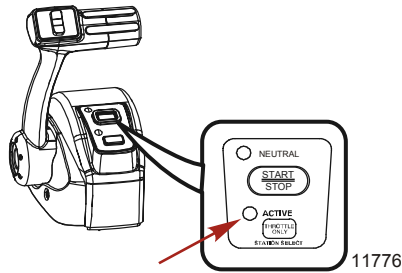

8. After engine starts, check for a steady stream of water flowing out of the water pump indicator hole.

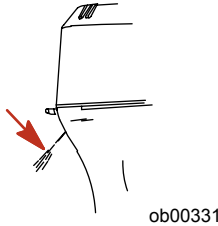

**IMPORTANT:** If no water is coming out of the water pump indicator hole, stop engine and check the cooling water intake for obstruction. No obstruction may indicate a water pump failure or blockage in the cooling system. These conditions will cause the engine to overheat. Have the outboard checked by your dealer. Operating the engine while overheated will cause engine damage.

## Warming up engine

Throttle Only/Station Select Button - This feature allows the boat operator to increase engine RPM for warm-up, without shifting the engine into gear.

# OPERATION

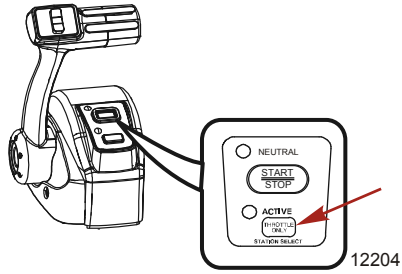

1. Move the control handle into neutral position.
2. Depress shift lock button, press and hold the throttle only/station select button while moving the control handle ahead to the forward detent.
3. Hold in the button until the horn sounds twice and the neutral light starts flashing. The flashing light indicates that the throttle only is engaged.
4. Advance the control handle to increase engine RPM. Engine RPM is limited to prevent engine damage.
5. To disengage, return the control handle back to neutral position.

## SHADOW MODE REMOTE CONTROL ENGINE STARTING PROCEDURE

Before starting, read the Pre-Starting Check List, Special Operating Instructions, and Engine Break-in Procedure in the Operation Section.

### ⚠ CAUTION

**Never start or operate your outboard (even momentarily) without water circulating through all the cooling water intake holes in the gearcase to prevent damage to the water pump (running dry) or overheating of the engine.**

1. Lower the outboard to the vertical operating position. Make sure all cooling water intake holes are submerged.

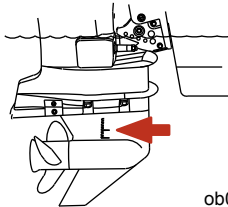

2. Open fuel tank vent on manual venting type tanks.

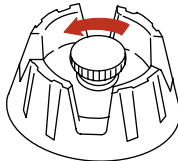

3. Squeeze the fuel line primer bulb several times until it feels firm.

# OPERATION

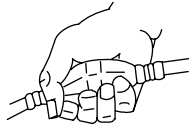

ob00349

**NOTE:** The engines will not start unless the lanyard is set to the "RUN" position.

4. Set the lanyard stop switch to the "RUN" position. Refer to **General Information - Lanyard Stop Switch**.



ob00350

5. Shift outboards to neutral (N) position.

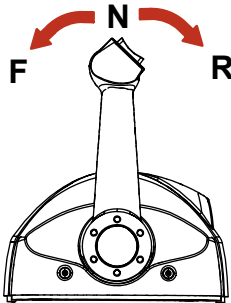

3417

6. For initial start of a new engine or for an engine that ran out of fuel, or was drained of fuel, the fuel system should be filled as follows:
  - a. Squeeze the fuel line primer bulb until it feels firm.
  - b. Turn the ignition key switch to the "ON" position for three seconds. This operates the electric fuel pump.
  - c. Turn the ignition key switch back to the "OFF" position, and squeeze the primer bulb again until it feels firm. Turn the ignition key switch to the "ON" position again for three seconds. Continue this procedure until the fuel line primer bulb stays firm.
7. Turn the each ignition key to "START" position and release the key. The electronic starting system will automatically crank the engine for starting. If engine fails to start, the engine will stop cranking. Return the key to "START" position and try again. Repeat the procedure for the other engines.

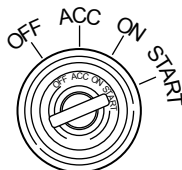

3485

8. The "ACTIVE" light will become illuminated to show the helm is active and ready for use..

# OPERATION

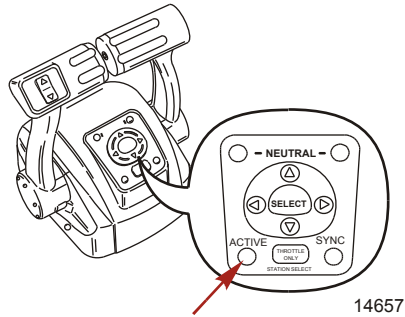

9. After engine starts, check for a steady stream of water flowing out of the water pump indicator hole.

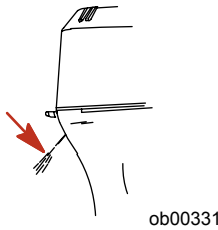

**IMPORTANT:** If no water is coming out of the water pump indicator hole, stop engine and check the cooling water intake for obstruction. No obstruction may indicate a water pump failure or blockage in the cooling system. These conditions will cause the engine to overheat. Have the outboard checked by your dealer. Operating the engine while overheated will cause engine damage.

## Warming up engines

Throttle Only/Station Select Button - This feature allows the boat operator to increase engine RPM for warm-up, without shifting the engines into gear.

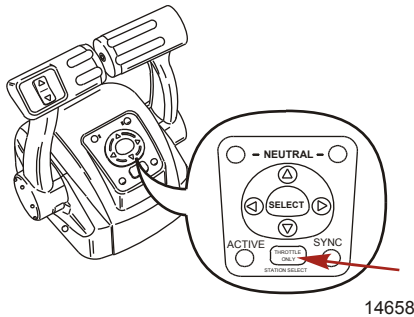

1. Move the control handles into neutral position.
2. Press and hold the throttle only/station select button while moving the control handles ahead to the forward detent.
3. Hold in the button until the horn sounds twice and the neutral lights starts flashing. The flashing lights indicates that the throttle only is engaged.
4. Advance the control handles to increase engine RPM. Engine RPM is limited to prevent engine damage.
5. To disengage, return the control handles back to neutral position.

# OPERATION

- 6. The warm up mode can be re-activated by turning off and re-starting the engines.

## Gear Shifting

### DTS PANEL MOUNT REMOTE CONTROL

**IMPORTANT:** Never shift outboard into gear unless engine speed is at idle. Do not shift outboard into forward or reverse when the engine is not running.

- The outboard has three gear shift positions to provide operation. Forward (F), Neutral (N) and Reverse (R).

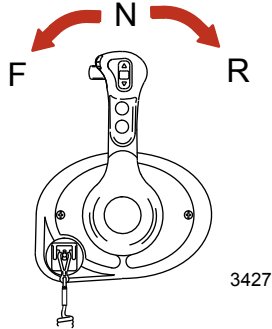

- When shifting, always stop at neutral position and allow the engine speed to return to idle.
- Panel mount remote control requires the operator to always press shift lock while moving the control handle out of the neutral position.

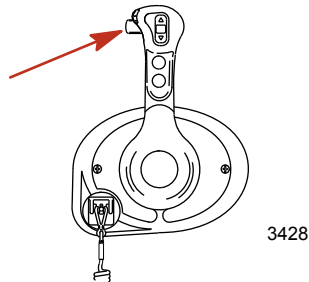

- Advance the control lever to further increase speed.

### DTS CONSOLE MOUNT REMOTE CONTROL

**IMPORTANT:** Never shift outboard into gear unless engine speed is at idle. Do not shift outboard into forward or reverse when the engine is not running.

- The outboard has three gear shift positions to provide operation. Forward (F), Neutral (N) and Reverse (R).



# OPERATION

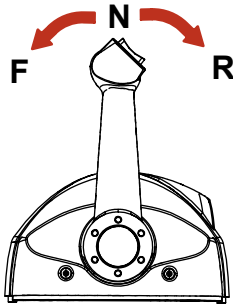

3417

- When shifting, always stop at neutral position and allow the engine speed to return to idle.
- Advance the control lever to further increase speed.

## Dual Helm Station Transfer

The throttle only/station select button allows the boat operator to select which remote control is in control of the engine operation.

The active light is illuminated at the remote control station that is in control of the engine.

### ⚠ WARNING

**Avoid serious injury or death from loss of boat control. The boat operator should never leave the active station while engine is in gear. Helm transfer should only be attempted while both stations are manned. One person helm transfer should only be performed while engine is in neutral.**

**NOTE:** Idle position is preferred when doing a station transfer. If conditions do not allow the remote control to be placed at idle position, a station transfer can be done while in gear.

**NOTE:** Pressing and releasing station select button at new station allows the engine control to be transferred to the new station. The control will automatically start adjusting engine RPM and gear position to match the control handle setting at the new station. Adjust control handles to the desired throttle and gear position.

1. Place active remote control lever to idle position.
2. Proceed to the inactive helm station and position remote control lever to the idle position.
3. Press throttle only/station select button once. The "ACTIVE" light will illuminate to indicate the remote control station is in control of the engine.

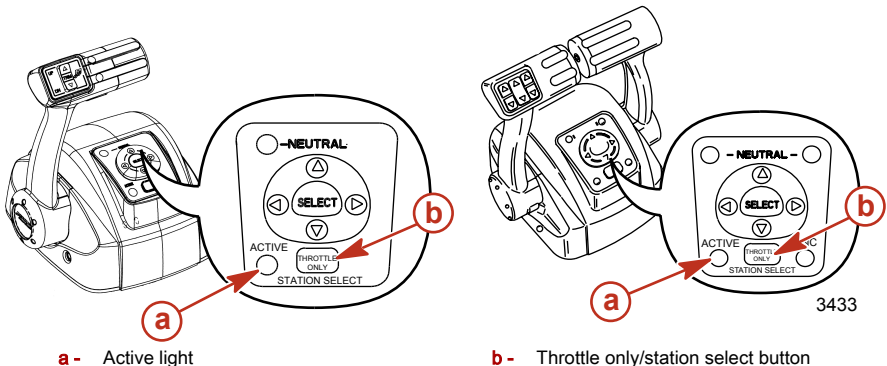

a - Active light

b - Throttle only/station select button

# OPERATION

4. The active light will switch off at the original remote control station.

## SYNCHRONIZING DUAL HELMS PRIOR TO STATION TRANSFER

Pressing the station select button and holding it in allows the boat operator ten seconds to match up the control handle settings at the new station with the handle settings that are at the old (to be inactive) station. If the handles are not matched, the neutral light will flash. The light blinks faster as the handles are nearing match position. Once light stays on solid, the handles are matched and the button can be released. Transfer process is complete and the new station is now in control. If the button is held for over 10 seconds, the station transfer is cancelled.

## Synchronizing Dual Engines

The auto synchronizing feature, when engaged, will automatically adjust the port engine speed to match the speed of the starboard engine.

Synchronizing of engines will automatically engage when the speed of both engines are over 900 RPM for two seconds and remote control handles are positioned are within 5° of each other.

Auto Synchronizing will stay engaged up to 95% throttle opening. The Sync light will turn on when the engines are synchronized.

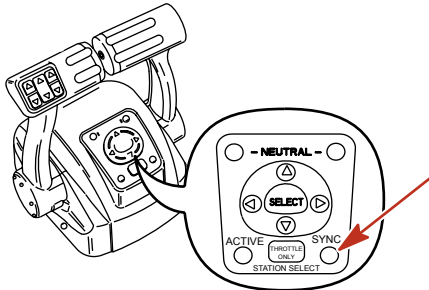

3434

To disengage, move one or both control handles until they are more than 5° apart, reduce engine speed below 900 RPM, or increase engine speed beyond 95%.

## Stopping The Engine

**IMPORTANT: Turning key to the "START" position while the engine is running will result in engine shut down, while leaving the DTS system active. This will allow the use of the power trim/tilt from the remote control handle.**

Reduce engine speed and shift outboard to neutral position. Turn ignition key to "OFF" position.



3482

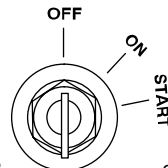

ob00360

# OPERATION

## Remote Control Adjustments

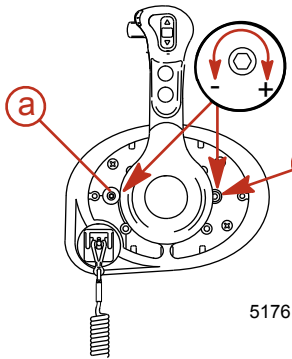

**a** - Detent tension adjustment

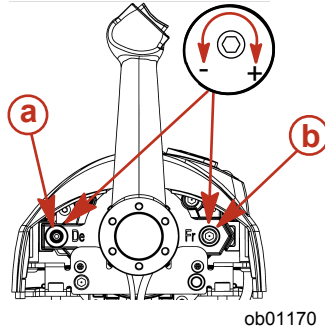

**b** - Control handle friction adjustment screw

1. Remove cover to gain access to screws.
2. **Detent tension adjustment** - The detent screw can be adjusted to increase or decrease the effort needed to move the control handle into or out of detent position.
3. **Control handle friction adjustment** - The friction adjustment screw can be adjusted to increase or decrease the overall effort to move the control handle. This will help prevent unwanted motion of the handle in rough water.
4. Turn screw towards "+" to increase friction or towards "-" to decrease friction.
5. Reinstall cover.

# MAINTENANCE

## Outboard Care

To keep your outboard in the best operating condition, it is important that your outboard receive the periodic inspections and maintenance listed in the Inspection and Maintenance Schedule. We urge you to keep it maintained properly to ensure the safety of you and your passengers, and retain its dependability.

### ⚠ WARNING

Neglected inspection and maintenance service of your outboard or attempting to perform maintenance or repair on your outboard if you are not familiar with the correct service and safety procedures could cause personal injury, death, or product failure.

Record maintenance performed in Maintenance Log at the back of this book. Save all maintenance work orders and receipts.

## SELECTING REPLACEMENT PARTS FOR YOUR OUTBOARD

We recommend using original Mercury Precision or Quicksilver replacement parts and Genuine Lubricants.

### ⚠ WARNING

Using a replacement part that is inferior to the original part could result in personal injury, death, or product failure.

## EPA Emissions

### EMISSION CERTIFICATION LABEL

An emission certification label, showing emission levels and engine specifications directly related to emissions, is placed on the engine at time of manufacture.

		EMISSION CONTROL INFORMATION	
This engine conforms to <input type="checkbox"/> model year EPA regulations for Marine SI engines. Refer to Owner's Manual for required maintenance.			
<b>a</b>	IDLE SPEED: <input type="text"/>	FAMILY: <input type="text"/>	<b>f</b>
<b>b</b>	<input type="text"/> hp <input type="text"/> cc	FEL: <input type="text"/> g/kWh	<b>g</b>
<b>c</b>	TIMING (IN DEGREES): <input type="text"/>	<input type="text"/>	<b>h</b>
<b>d</b>	Standard spark plug: <input type="text"/>	<input type="text"/>	<b>i</b>
	Suppressor spark plug: <input type="text"/>		
	GAP: <input type="text"/>		
<b>e</b>	Valve Clearance (Cold) mm	Intake <input type="text"/>	
		Exhaust <input type="text"/>	

ob1071

- a** - Idle speed
- b** - Engine horsepower
- c** - Timing specification
- d** - Recommended spark plug and gap
- e** - Valve clearance (if applicable)
- f** - Family number
- g** - Maximum emission output for the engine family
- h** - Piston placement
- i** - Date of manufacture

## OWNER RESPONSIBILITY

The owner/operator is required to have routine engine maintenance performed to maintain emission levels within prescribed certification standards.

The owner/operator is not to modify the engine in any manner that would alter the horsepower or allow emissions levels to exceed their predetermined factory specifications.

# MAINTENANCE

## Inspection And Maintenance Schedule

### BEFORE EACH USE

- Check that lanyard stop switch stops the engine.
- Visually inspect the fuel system for deterioration or leaks.
- Check outboard for tightness on transom.
- Check steering system for binding or loose components.
- Visually check steering link rod fasteners for proper tightness. See **Steering Link Rod Fasteners**.
- Check propeller blades for damage.

### AFTER EACH USE

- Flush out the outboard cooling system if operating in salt or polluted water. See **Flushing the Cooling System**.
- Wash off all salt deposits and flush out the exhaust outlet of the propeller and gearcase with fresh water if operating in salt water.

### EVERY 100 HOURS OF USE OR ONCE YEARLY, WHICHEVER OCCURS FIRST

- Lubricate all lubrication points. Lubricate more frequently when used in salt water. See **Lubrication Points**.
- Replace spark plugs at first 100 hours or first year. After that, inspect spark plugs every 100 hours or once yearly. Replace spark plugs as needed. See **Spark Plug Inspection and Replacement**.
- Replace fuel filter. See **Fuel System**.
- Replace compressor air intake filter. See **Compressor Air Intake Filter**.
- Inspect alternator belt. See **Alternator Belt Inspection**.
- Check corrosion control anodes. Check more frequently when used in salt water. See **Corrosion Control Anodes**.
- Drain and replace gearcase lubricant. See **Gearcase Lubrication**.
- Check power trim fluid. See **Checking Power Trim Fluid**.
- Inspect battery. See **Battery Inspection**.
- Lubricate splines on the driveshaft and shift shaft.<sup>1</sup>
- Check tightness of bolts, nuts, and other fasteners.
- Check cowl seals to make sure seals are intact and not damaged.
- Check internal cowl sound reduction foam (if equipped) to make sure foam is intact and not damaged.
- Check that the intake silencer (if equipped) is in place.
- Check that the idle relief muffler (if equipped) is in place.
- Check for loose hose clamps and rubber boots (if equipped) on the air intake assembly.

### EVERY 300 HOURS OF USE OR THREE YEARS

- Replace water pump impeller (more often if overheating occurs or reduced water pressure is noted).<sup>1</sup>
- Replace the two in-line oil filters located in the air compressor oil return lines.<sup>1</sup>

### BEFORE PERIODS OF STORAGE

- Refer to Storage procedure. See **Storage** section.

## Flushing The Cooling System

Flush the internal water passages of the outboard with fresh water after each use in salt, polluted, or muddy water. This will help prevent a buildup of deposits from clogging the internal water passages.

1. These items should be serviced by an authorized dealer.

# MAINTENANCE

**NOTE:** Engine can be stopped or running at idle speed when flushing the cooling system. Do not flush engine using a water system that exceeds 310.26 kPa (45 psi).

1. Remove the plug from fitting in the bottom cowl.

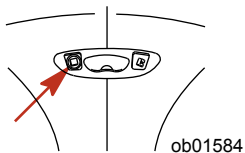

2. Attach a water hose to the fitting. Turn on the water and flush for 3 to 5 minutes.

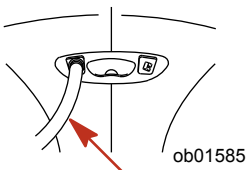

## Top Cowl Removal And Installation

### REMOVAL

1. Release the front and side cowl latches.
2. Lift the top cowl from the outboard.

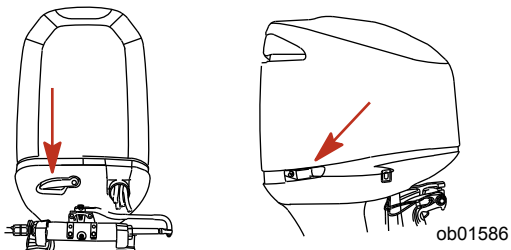

### INSTALLATION

1. Position the top cowl over the engine.
2. Ensure the bottom rubber seal fits properly and lock the front and side latches.

## Cleaning Care for Top Cowl

**IMPORTANT:** Dry wiping (wiping the plastic surface when it is dry) will result in minor surface scratches. Always wet the surface before cleaning. Follow cleaning and waxing procedure.

### CLEANING AND WAXING PROCEDURE

1. Before washing, rinse the top cowl with clean water to remove dirt and dust that may scratch the surface.
2. Wash the top cowl with clean water and a mild non-abrasive soap. Use a soft clean cloth when washing.
3. Dry thoroughly with a soft clean cloth.
4. Wax the surface using a non-abrasive automotive polish (polish designed for clear coat finishes). Remove the applied wax by hand using a clean soft cloth.

# MAINTENANCE

## Alternator Belt Inspection

1. Inspect the alternator belt and have it replaced by an authorized dealer if any of the following conditions are found.
  - a. Cracks or deterioration in the rubber portion of the belt.
  - b. Belt surfaces rough or uneven.
  - c. Signs of wear on edges or outer surfaces of belt.

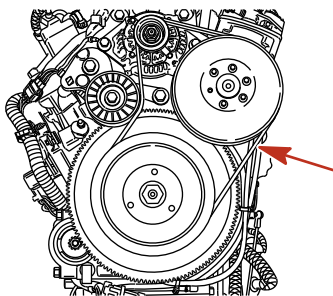

ob01587

## Fuel System

### **WARNING**

**Avoid serious injury or death from gasoline fire or explosion. Carefully follow all fuel system service instructions. Always stop the engine and do not smoke or allow open flames or sparks in the area while servicing any part of the fuel system.**

Before servicing any part of the fuel system, stop engine and disconnect the battery. Drain the fuel system completely. Use an approved container to collect and store fuel. Wipe up any spillage immediately. Material used to contain spillage must be disposed of in an approved receptacle. Any fuel system service must be performed in a well ventilated area. Inspect any completed service work for sign of fuel leakage.

## FUEL LINE INSPECTION

Visually inspect the fuel line and primer bulb for cracks, swelling, leaks, hardness, or other signs of deterioration or damage. If any of these conditions are found, the fuel line or primer bulb must be replaced.

## FUEL FILTER REPLACEMENT

### Removal

1. Use the shaft of a screwdriver between the lugs on the filter cap and unscrew the filter.

### Installation

1. Lubricate the O-ring seals with oil.

# MAINTENANCE

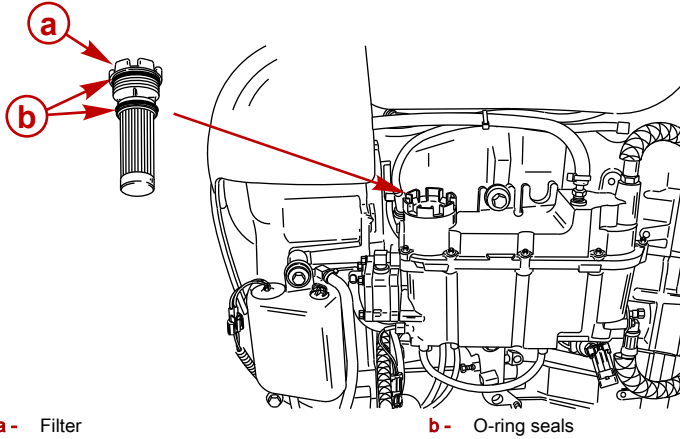

3388

**a-** Filter

**b-** O-ring seals

2. Install the fuel filter and tighten securely.

**IMPORTANT:** Visually inspect for fuel leakage from the filter while squeezing the primer bulb until firm, forcing fuel into the filter.

## DRAINING WATER FROM THE FUEL FILTER CHAMBER

**NOTE:** If a sufficient amount of water has accumulated in the fuel filter chamber, the warning system will turn on. Draining the water from the fuel filter chamber is required.

1. Pull the drain hose off the right side fitting. Hold open end of the hose over a container.
2. Loosen drain screw and drain the fuel filter chamber.
3. Retighten drain screw and reattach hose.

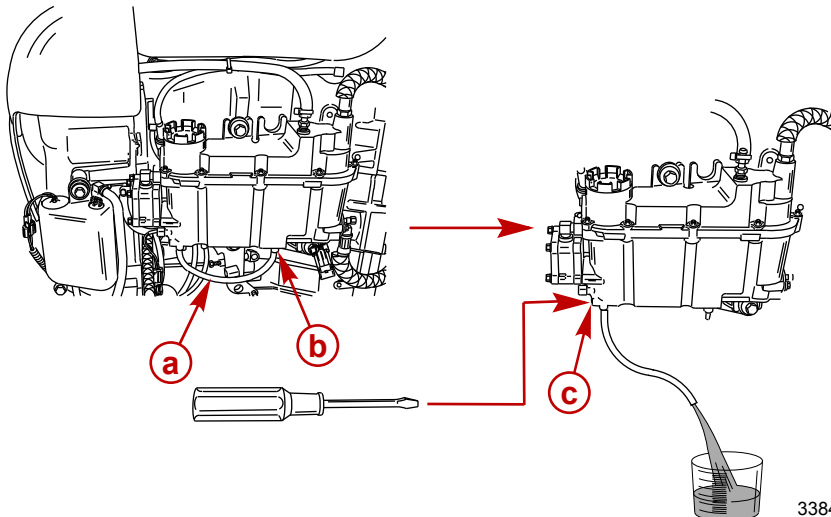

3384

**a-** Drain hose

**b-** Side fitting

**c-** Drain screw



# MAINTENANCE

**IMPORTANT:** Visually inspect for fuel leakage from the drain screw by squeezing the primer bulb until firm, forcing fuel into the chamber.

## Steering Link Rod Fasteners

**IMPORTANT:** The steering link rod that connects the steering cable to the engine must be fastened using special washer head bolt ("a" - Part Number 10-849838) and self-locking nylon insert locknuts ("c" & "d" - Part Number 11-826709113). These locknuts must never be replaced with common nuts (non-locking) as they will work loose and vibrate off freeing the link rod to disengage.

### ⚠ WARNING

Disengagement of a steering link rod can result in the boat taking a full, sudden, sharp turn. This potentially violent action can cause occupants to be thrown overboard exposing them to serious injury or death.

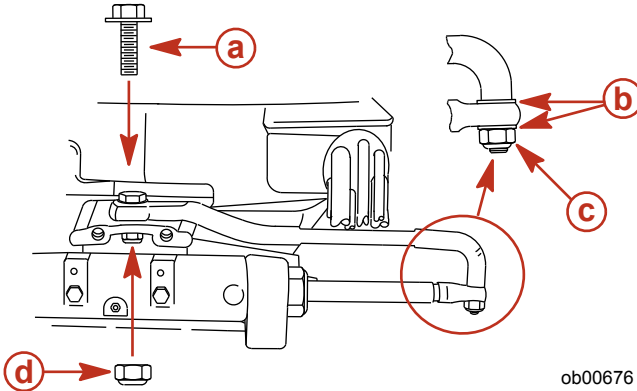

ob00676

- a- Special washer head bolt (10-849838)
- b- Flat washer (2)

- c- Nylon insert locknut (11-826709113)
- d- Nylon insert locknut (11-826709113)

Description	Nm	lb. in.	lb. ft.
Special washer head bolt	27		20
Nylon insert locknut "d"	27		20
Nylon insert locknut "c"	Tighten until seats, then back off 1/4 turn		

Assemble steering link rod to steering cable with two flat washers and self-locking nylon insert locknut. Tighten locknut until it seats, then back nut off 1/4 turn.

Assemble steering link rod to engine with special washer head bolt and self-locking nylon insert locknut. First torque bolt, then torque locknut to specifications.

## Fuse Replacement

**IMPORTANT:** Always carry spare 2, 5 and 20 AMP fuses.

The electrical wiring circuits on the outboard are protected from overload by fuses in the wiring. If a fuse is blown, try to locate and correct the cause of the overload. If the cause is not found, the fuse may blow again.

Open the fuse holder and look at the silver colored band inside the fuse. If band is broken, replace the fuse. Replace fuse with a new fuse with the same rating.

# MAINTENANCE

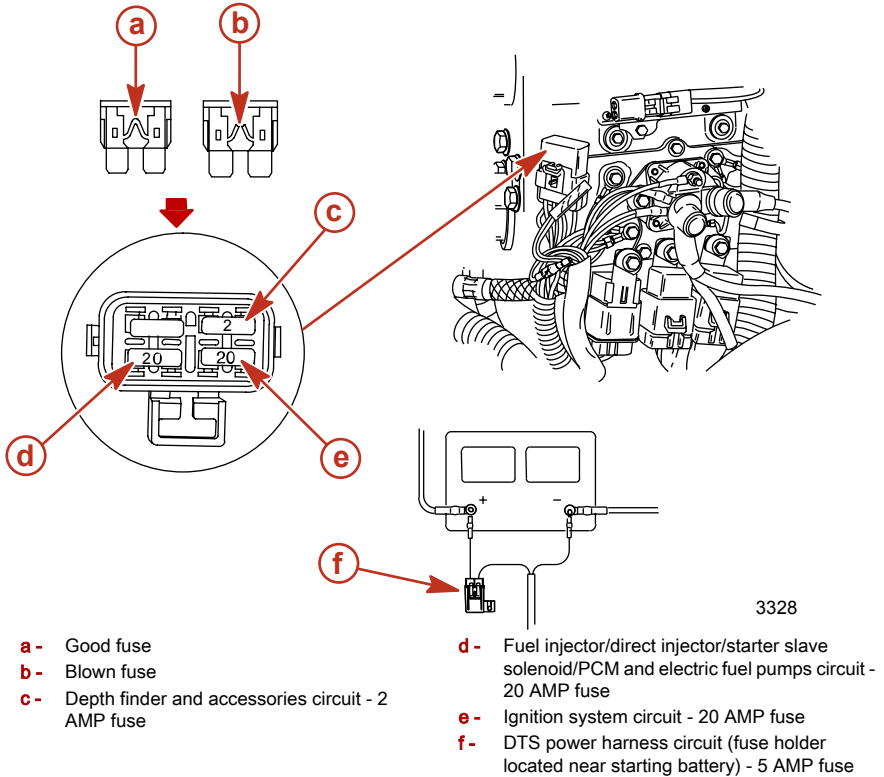

## DTS Wiring System

### ⚠ WARNING

To avoid the possibility of serious injury or death from loss of boat control, do not splice or probe into any wire insulation of the DTS system. Splicing or probing will damage the wire insulation allowing water to enter the wiring. Water intrusion may lead to wiring failure and loss of throttle and shift control.

- Verify the harnesses are not routed near sharp edges, hot surfaces or moving parts.
- Verify that all unused connectors and receptacles are covered with a weather cap.
- Verify that the harnesses are fastened along the routing path.

## Corrosion Control Anode

Your outboard has corrosion control anodes at different locations. An anode helps protect the outboard against galvanic corrosion by sacrificing its metal to be slowly corroded instead of the outboard metals.

Each anode requires periodic inspection, especially in salt water which will accelerate the erosion. To maintain this corrosion protection, always replace the anode before it is completely eroded. Never paint or apply a protective coating on the anode as this will reduce effectiveness of the anode.

# MAINTENANCE

The gearcase has three anodes. Two anodes are located on each side of the gearcase, and a third is an anode plate installed underneath the anti-ventilation plate. If a trim tab should be installed, this anode plate will be removed. Another anode is installed on the bottom of the transom bracket assembly.

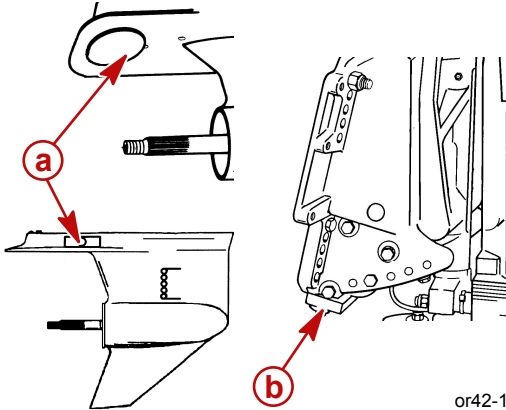

or42-1

**a-** Corrosion control anodes (gearcase)

**b-** Corrosion control anode (transom bracket)

## Battery Inspection

The battery should be inspected at periodic intervals to ensure proper engine starting capability.

**IMPORTANT: Read the safety and maintenance instructions which accompany your battery.**

1. Turn off the engine before servicing the battery.
2. Add water as necessary to keep the battery full.
3. Make sure the battery is secure against movement.
4. Battery cable terminals should be clean, tight, and correctly installed. Positive to positive and negative to negative.
5. Make sure the battery is equipped with a nonconductive shield to prevent accidental shorting of battery terminals.

## Battery Information

### ⚠ CAUTION

Hex nuts must be used to secure battery leads to battery posts to avoid loss of electrical power.

- Do not use deep cycle batteries. Engines must use a marine starting battery with 1000 MCA, 800 CCA or 180 Ah.
- When connecting engine battery, hex nuts must be used to secure battery leads to battery posts. Torque nuts to specification.

Description	Nm	lb. in.	lb. ft.
Hex nuts	13.5	120	

# MAINTENANCE

**IMPORTANT:** Battery cable size and length is critical. Refer to engine installation manual for size requirements.

Decal needs to be placed on or near battery box for future service reference. One 5/16 in. and one 3/8 in. hex nut are supplied per battery for wing nut replacement. Metric hex nuts are not supplied.

**NOTICE - DTS & Optimax Engines**

**DO NOT USE DEEP CYCLE BATTERIES!**

DTS (Digital Throttle and Shift) applications and Optimax engines must use a marine starting battery with 1000 MCA, 800 CCA, or 180 Ah. rating.

13.5Nm (120 lbs. in.)

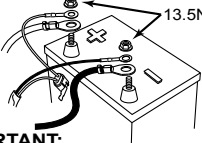

**DO NOT USE WING NUTS.**

**IMPORTANT:**  
Battery cable size and length is critical. Refer to engine installation manual for size requirements.  
37-895387

Place decal on or near battery box for future service reference. 5/16" and 3/8" hex nuts supplied for wing nut replacement. Metric hex nuts not supplied.

3486

## Propeller Replacement

### **WARNING**

If the propeller shaft is rotated while the engine is in gear, there is the possibility that the engine will crank over and start. To prevent this type of accidental engine starting and possible serious injury caused from being struck by a rotating propeller, always shift outboard to neutral position and remove spark plug leads when you are servicing the propeller.

1. Shift outboard to neutral (N) position.

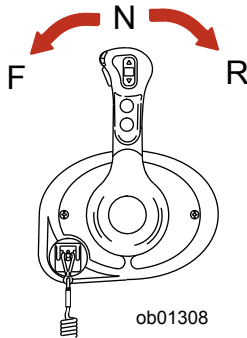

**IMPORTANT:** Refer to Spark Plug Inspection and Replacement for removing spark plug leads.

2. Remove spark plug leads to prevent engine from starting.

# MAINTENANCE

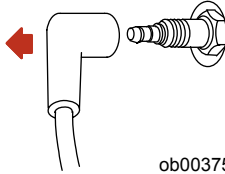

ob00375

3. Straighten the bent tabs on the propeller nut retainer.

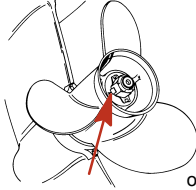

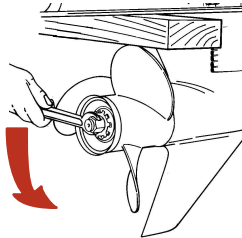

ob00376

4. Place a block of wood between gearcase and propeller to hold propeller and remove propeller nut.



ob01672

5. Pull propeller straight off shaft. If propeller is seized to the shaft and cannot be removed, have the propeller removed by an authorized dealer.
6. Coat the propeller shaft with Quicksilver or Mercury Precision Lubricants Anti-Corrosion Grease or 2-4-C with Teflon.

Tube Ref No.	Description	Where Used	Part No.
 94	Anti-Corrosion Grease	Propeller shaft	92-802867Q1
 95	2-4-C with Teflon	Propeller shaft	92-802859Q1

**IMPORTANT:** To prevent the propeller hub from corroding and seizing to the propeller shaft, especially in salt water, always apply a coat of the recommended lubricant to the entire propeller shaft at the recommended maintenance intervals and also each time the propeller is removed.

7. Flo-Torq I Drive Hub Propellers - Install forward thrust hub, propeller, continuity washer, rear thrust hub, propeller nut retainer, and propeller nut onto the shaft.

# MAINTENANCE

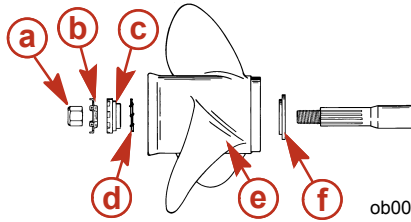

- a-** Propeller nut
- b-** Propeller nut retainer
- c-** Rear thrust hub
- d-** Continuity washer
- e-** Propeller
- f-** Forward thrust hub

8. Flo-Torq II Drive Hub Propellers - Install forward thrust hub, replaceable drive sleeve, propeller, thrust hub, propeller nut retainer and propeller nut onto the shaft.

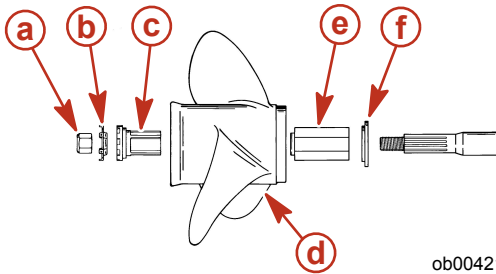

- a-** Propeller nut
- b-** Propeller nut retainer
- c-** Rear thrust hub
- d-** Propeller
- e-** Replaceable drive sleeve
- f-** Forward thrust hub

9. Place a block of wood between gearcase and propeller and torque to specifications.

Description	Nm	lb. in.	lb. ft.
Propeller nut	75		55

10. Secure propeller nut by bending three of the tabs into the thrust hub grooves.

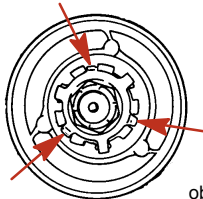

# MAINTENANCE

## Spark Plug Inspection And Replacement

### ⚠ WARNING

Avoid serious injury or death from fire or explosion caused by damaged spark plug boots. Damaged spark plug boots can emit sparks. Sparks can ignite fuel vapors under the engine cowl. To avoid damaging spark plug boots, do not use any sharp object or metal tool such as pliers, screwdriver, etc. to remove spark plug boots.

1. Remove the spark plug leads. Twist the rubber boots slightly and pull off.

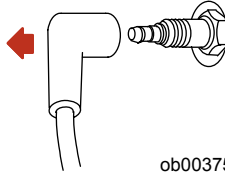

2. Remove the spark plugs to inspect. Replace spark plug if electrode is worn or the insulator is rough, cracked, broken, blistered or fouled.

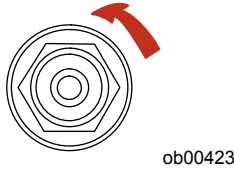

3. Set the spark plug gap to specification.

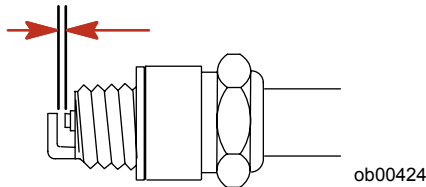

### Spark Plug

Spark plug gap

0.80 mm (0.031 in.)

4. Before installing spark plugs, clean off any dirt on the spark plug seats. Install plugs finger tight, and then tighten 1/4 turn or torque to specifications.

Description	Nm	lb. in.	lb. ft.
Spark plug	27		20

## Compressor Air Intake Filter

The filter should be changed every 100 hours of operation, or once a season.

**IMPORTANT: Never run the engine without the air filter.**

### REMOVAL

1. Remove the hose clamp and pull the hose off the air filter.

# MAINTENANCE

2. Rotate the filter 1/4 turn to the unlock position to remove.

## INSTALLATION

1. Place the nylon washer and rubber washer onto the filter cover.

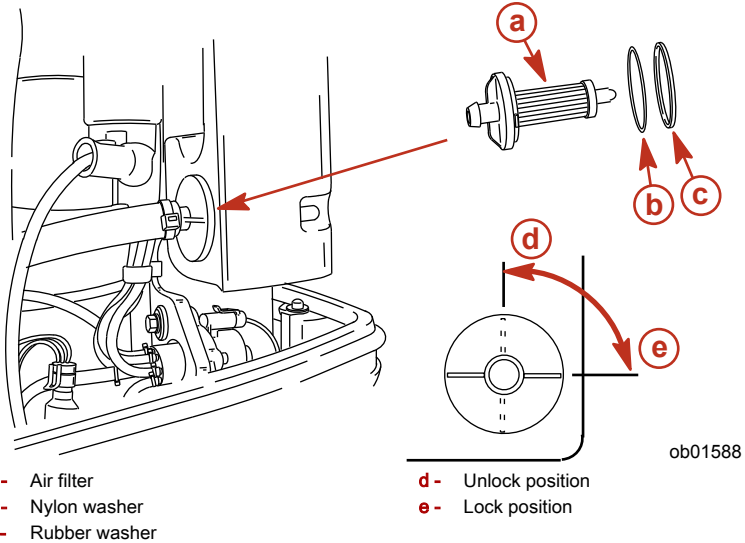

2. Insert filter into opening. Place the front tip of the filter into the through hole and align the two tabs on the filter cover with the notches in the opening.
3. Rotate the filter 1/4 turn to the lock position.
4. Reinstall the hose and secure with clamp.

## Lubrication Points

1. Lubricate the following with Quicksilver or Mercury Precision Special Lubricant 101.

Tube Ref No.	Description	Where Used	Part No.
 34	Special Lubricant 101	Trim rod ball ends	92-802865Q1

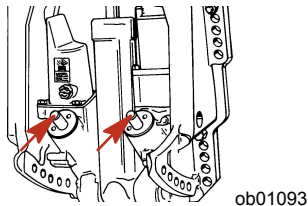

- Trim Rod Ball Ends - Turn the ball ends to work the lubricant into the ball sockets.



2. Lubricate the following with Quicksilver or Mercury Precision Lubricants Anti-Corrosion Grease or 2-4-C with Teflon.





# MAINTENANCE

Tube Ref No.	Description	Where Used	Part No.
 94	Anti-Corrosion Grease	Propeller shaft	92-802867Q1
 95	2-4-C with Teflon	Propeller shaft	92-802859Q1

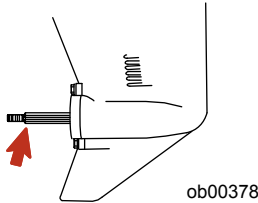
- Propeller Shaft - Refer to **Propeller Replacement** for removal and installation of the propeller. Coat the entire propeller shaft with lubricant to prevent the propeller hub from corroding and seizing to the shaft.



3. Lubricate the following with Quicksilver or Mercury Precision Lubricants 2-4-C with Teflon or Special Lubricant 101.

Tube Ref No.	Description	Where Used	Part No.
 34	Special Lubricant 101	Alternator belt tensioner pivot shaft, swivel bracket, tilt support lever, tilt tube, steering cable	92-802865Q1
 95	2-4-C with Teflon	Alternator belt tensioner pivot shaft, swivel bracket, tilt support lever, tilt tube, steering cable	92-802859Q1

- Alternator Belt Tensioner Pivot Shaft - Lubricate through fitting.

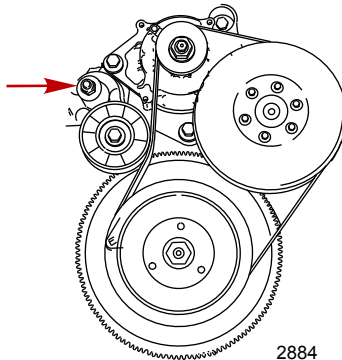

- Swivel Bracket - Lubricate through fitting.

# MAINTENANCE

- Tilt Support Lever - Lubricate through fitting.

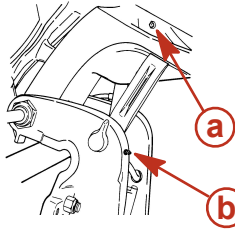

ob00683

**a-** Swivel bracket

**b-** Tilt support lever

- Tilt Tube - Lubricate through fitting.

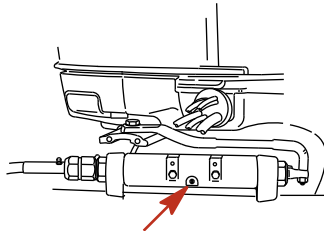

ob00684

## **⚠ WARNING**

The end of the steering cable must be fully retracted into the outboard tilt tube before adding lubricant. Adding lubricant to steering cable when fully extended could cause steering cable to become hydraulically locked. A hydraulically locked steering cable will cause loss of steering control, possibly resulting in serious injury or death.

- Steering Cable - Rotate steering wheel to fully retract the steering cable end into the outboard tilt tube. Lubricate through fitting.

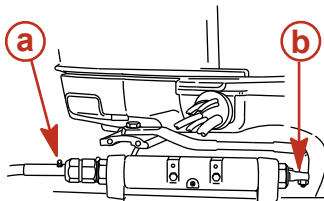

ob00685

**a-** Fitting

**b-** Cable end

4. Lubricate the following with Light Weight Oil.
  - Steering Link Rod Pivot Points - Lubricate pivot points.

# MAINTENANCE

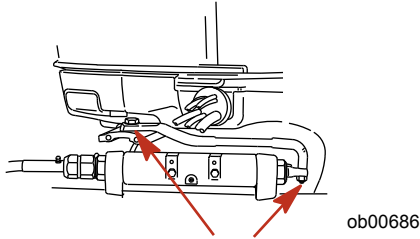

## Checking Power Trim Fluid

1. Tilt outboard to the full up position and engage the tilt support lever.

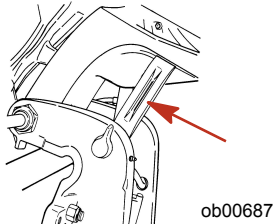

2. Remove fill cap and check fluid level. The fluid level should be even with the bottom of the fill hole. Add Quicksilver or Mercury Precision Lubricants Power Trim & Steering Fluid. If not available, use automotive (ATF) automatic transmission fluid.

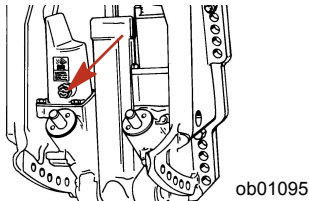

## Gearcase Lubrication

When adding or changing gearcase lubricant, visually check for the presence of water in the lubricant. If water is present, it may have settled to the bottom and will drain out prior to the lubricant, or it may be mixed with the lubricant, giving it a milky colored appearance. If water is noticed, have the gearcase checked by your dealer. Water in the lubricant may result in premature bearing failure or, in freezing temperatures, will turn to ice and damage the gearcase.

Examine the drained gearcase lubricant for metal particles. A small amount of metal particles indicates normal gear wear. An excessive amount of metal filings or larger particles (chips) may indicate abnormal gear wear and should be checked by an authorized dealer.

## DRAINING GEARCASE

1. Place outboard in a vertical operating position.
2. Place drain pan below outboard.
3. Remove vent plug and fill/drain plug and drain lubricant.

# MAINTENANCE

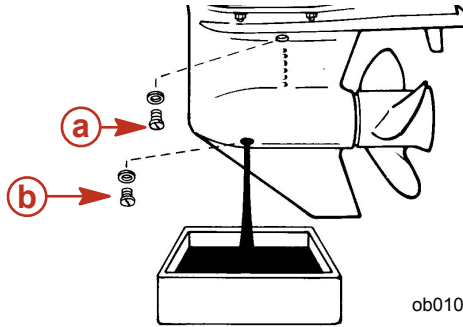

ob01096

**a-** Vent plug

**b-** Fill/drain plug

## GEARCASE LUBRICANT CAPACITY

Gearcase lubricant capacity is approximately 798 ml (27 fl. oz.).

## GEARCASE LUBRICANT RECOMMENDATION

Mercury or Quicksilver High Performance Gear Lubricant.

## CHECKING LUBRICANT LEVEL AND REFILLING GEARCASE

1. Place outboard in a vertical operating position.
2. Remove vent plug.
3. Remove fill/drain plug. Place lubricant tube into the fill hole and add lubricant until it appears at the vent hole.

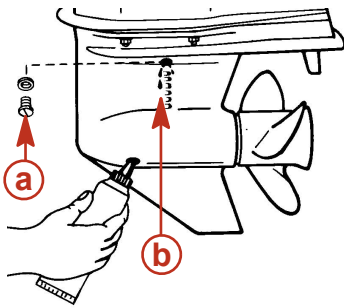

**a-** Vent plug

**b-** Vent hole

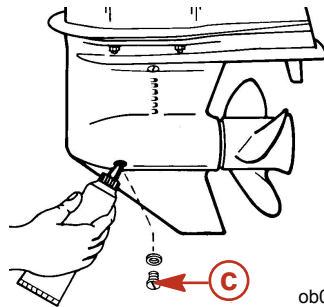

ob01097

**c-** Fill/drain plug

**IMPORTANT: Replace sealing washers if damaged.**

4. Stop adding lubricant. Install the vent plug and sealing washer before removing the lubricant tube.
5. Remove lubricant tube and reinstall cleaned fill/drain plug and sealing washer.

## Submerged Outboard

A submerged outboard will require service within a few hours by an authorized dealer once the outboard is recovered from the water. This immediate attention by a servicing dealer is necessary once the engine is exposed to the atmosphere to minimize internal corrosion damage to the engine.

# STORAGE

## Storage Preparation

The major consideration in preparing your outboard for storage is to protect it from rust, corrosion, and damage caused by freezing of trapped water.

The following storage procedures should be followed to prepare your outboard for out of season storage or prolonged storage (two months or longer).

### ⚠ CAUTION

Never start or operate your outboard (even momentarily) without water circulating through all the cooling water intake holes in the gearcase to prevent damage to the water pump (running dry) or overheating of the engine.

## FUEL SYSTEM

**IMPORTANT:** Gasoline containing alcohol (ethanol or methanol) can cause a formation of acid during storage and can damage the fuel system. If the gasoline being used contains alcohol, it is advisable to drain as much of the remaining gasoline as possible from the fuel tank, remote fuel line, and engine fuel system.

The most effective method of storage preparation is to add the recommended amount of Mercury Precision Fuel Stabilizer and Mercury Precision Quickleen products as described on the containers to the fuel tank before the last operation of the boat. Adding fuel stabilizer will help prevent the formation of varnish and gum in the gasoline. The Mercury Precision Quickleen product will help clean and lubricate the fuel injectors.

1. Portable Fuel Tank - Pour the required amount of gasoline stabilizer and Quickleen (follow instructions on containers) into fuel tank. Tip fuel tank back and forth to mix stabilizer and Quickleen with the fuel.
2. Permanently Installed Fuel Tank - Pour the required amount of gasoline stabilizer and Quickleen (follow instructions on containers) into a separate container and mix with approximately 1 liter (1 quart) of gasoline. Pour this mixture into fuel tank.
3. Pull the drain hose off the right side fitting. Hold open end of the hose over a container.
4. Loosen drain screw and drain the fuel filter chamber.

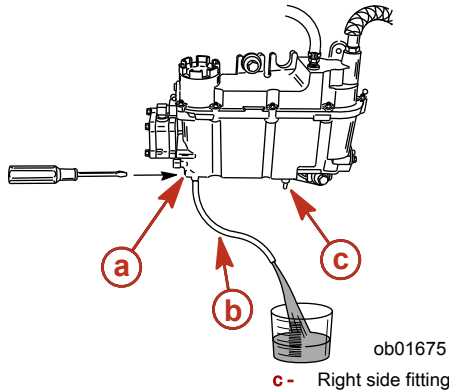

5. Retighten drain screw and reattach hose.
6. Pull the drain hose off the left side fitting. Hold the open end of the hose over a container.
7. Loosen drain screw and drain the float chamber.

# STORAGE

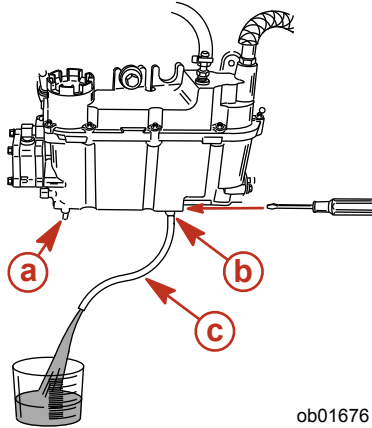

ob01676

- a- Left side fitting
- b- Drain screw

c- Drain hose

8. Retighten drain screw and reattach hose.
9. Premix the following in a container:
  - a. 8 cc (0.27 oz.) or 2 teaspoons of Mercury Precision Quickleen lubricant.
  - b. 8 cc (0.27 oz.) or 2 teaspoons of Mercury Precision Fuel Stabilizer.
10. Remove the fuel filter. See **Maintenance - Fuel System** for procedure.
11. Pour this mixture into the fuel filter opening. Reinstall the fuel filter.
12. Prime the fuel system. See **Operation - Starting The Engine**.
13. Place the outboard in water or connect flushing attachment for circulating cooling water. Start the engine and run at idle speed for five minutes to allow the treated fuel to fill the fuel system.

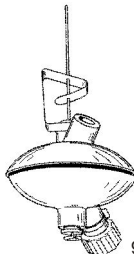
Flushing Device	91-44357Q 2
 <p style="text-align: right;">9192</p>	Attaches to the water intakes; provides a fresh water connection when flushing the cooling system or operating the engine.

## Protecting Internal Engine Components

**NOTE:** Make sure the fuel system has been prepared for storage. Refer to **Fuel System**, preceding.

**IMPORTANT:** Refer to **Spark Plug Inspection and Replacement** for correct procedure for removing spark plug leads.

1. Remove the spark plugs and add approximately 30 ml (1 oz.) of engine oil into each spark plug hole.
2. Rotate the flywheel manually several times to distribute the oil in the cylinders.
3. Re-install spark plugs.

# STORAGE

## Protecting External Outboard Components

- Lubricate all outboard components listed in **Maintenance - Inspection and Maintenance Schedule**.
- Touch up any paint nicks. See your dealer for touch-up paint.
- Spray Quicksilver or Mercury Precision Lubricants Corrosion Guard on external metal surfaces (except corrosion control anodes).

Tube Ref No.	Description	Where Used	Part No.
	Corrosion Guard	External metal surfaces	92-802878Q5 5

## Gearcase

- Drain and refill the gearcase lubricant (refer to **Maintenance - Gearcase Lubrication**).

## Positioning Outboard For Storage

Store outboard in an upright (vertical) position to allow water to drain out of outboard.

### CAUTION

If outboard is stored tilted up in freezing temperature, trapped cooling water or rain water that may have entered the propeller exhaust outlet in the gearcase could freeze and cause damage to the outboard.

## Battery Storage

- Follow the battery manufacturer's instructions for storage and recharging.
- Remove the battery from the boat and check water level. Recharge if necessary.
- Store the battery in a cool, dry place.
- Periodically check the water level and recharge the battery during storage.

# TROUBLESHOOTING

## Starter Motor Will Not Crank the Engine

### POSSIBLE CAUSES

- Lanyard stop switch not in "RUN" position.
- Blown 5 Amp fuse. Check DTS power harness circuit fuse. Refer to **Maintenance** section.
- Outboard is not shifted to neutral position.
- Shift actuator failure. "Gear Shift Diff" error message shown on System View. Refer to **Maintenance** section.
- Weak battery or battery connections are loose or corroded.
- Ignition key switch failure.
- Wiring or electrical connection faulty.
- Starter motor solenoid or slave solenoid failure.

## Engine Will Not Start

### POSSIBLE CAUSES

- Lanyard stop switch not in "RUN" position.
- Battery not fully charged.
- Incorrect starting procedure. Refer to **Operation** section.
- Old or contaminated fuel.
- Fuel is not reaching the engine.
  - Fuel tank is empty.
  - Fuel tank vent not open or restricted.
  - Fuel line is disconnected or kinked.
  - Primer bulb not squeezed.
  - Primer bulb check valve is faulty.
  - Fuel filter is obstructed. Refer to **Maintenance** section.
  - Fuel pump failure.
  - Fuel tank filter obstructed.
- Open 20 amp fuse. Check fuses, refer to **Maintenance** section.
- Threaded connection of an air hose is loose.
- Ignition system component failure.
- Spark plugs fouled or defective. Refer to **Maintenance** section.

## Engine Starts But Will Not Shift Into Gear

- Shift actuator failure. "Gear Shift Diff" error message shown on System View. Refer to **Maintenance** section.

## Engine Runs Erratically

### POSSIBLE CAUSES

- Spark plugs fouled or defective. Refer to **Maintenance** section.
- Incorrect setup and adjustments.
- Fuel is being restricted to the engine.
  - a. Engine fuel filter is obstructed. Refer to **Maintenance** section.
  - b. Fuel tank filter obstructed.
  - c. Stuck anti-siphon valve on built in fuel tank.
  - d. Fuel line is kinked or pinched.
  - e. Injector plugged.



# TROUBLESHOOTING

- Threaded connection of an air hose is loose.
- Fuel pump failure.
- Ignition system component failure.

## Performance Loss

### POSSIBLE CAUSES

- Throttle not fully open.
- Damaged propeller or improper propeller size.
- Boat overloaded or load improperly distributed.
- Excessive water in bilge.
- Boat bottom is dirty or damaged.

## Battery Will Not Hold Charge

### POSSIBLE CAUSES

- Battery connections are loose or corroded.
- Low electrolyte level in battery.
- Worn out or inefficient battery.
- Excessive use of electrical accessories.
- Defective rectifier, alternator, or voltage regulator.
- Open circuit in the alternator output wire (fused link).

# OWNER SERVICE ASSISTANCE

## Local Repair Service

Always return your outboard to your local authorized dealer should the need for service arise. Only he has the factory trained mechanics, knowledge, special tools, equipment, and genuine parts and accessories to properly service your engine should the need occur. He knows your engine best.

## Service Away From Home

If you are away from your local dealer and the need arises for service, contact the nearest authorized dealer. Refer to the Yellow Pages of the telephone directory. If, for any reason, you cannot obtain service, contact the nearest Mercury Marine Service Office.

## Parts And Accessories Inquiries

All inquiries concerning genuine replacement parts and accessories should be directed to your local authorized dealer. The dealer has the necessary information to order parts and accessories for you. When inquiring on parts and accessories, the dealer requires the model and serial number to order the correct parts.

## Service Assistance

Your satisfaction with your outboard product is very important to your dealer and to us. If you ever have a problem, question or concern about your outboard product, contact your dealer or any authorized Mercury Marine dealership. If additional assistance is required, take these steps.

1. Talk with the dealership's sales manager or service manager. If this has already been done, then contact the owner of the dealership.
2. Should you have a question, concern, or problem that cannot be resolved by your dealership, please contact Mercury Marine Service Office for assistance. Mercury Marine will work with you and your dealership to resolve all problems.

The following information will be needed by the service office:

- Your name and address
- Daytime telephone number
- Model and serial number of your outboard
- The name and address of your dealership
- Nature of problem

## Mercury Marine Service Offices

For assistance, call, fax, or write. Please include your daytime telephone number with mail and fax correspondence.

United States		
Telephone	(920) 929-5040	Mercury Marine W6250 W. Pioneer Road P.O. Box 1939 Fond du Lac, WI 54936-1939
Fax	(920) 929-5893	
Website	www.mercurymarine.com	

Canada		
Telephone	(905) 567-6372	Mercury Marine Ltd. 2395 Meadowpine Blvd. Mississauga, Ontario L5N 7W6 Canada
Fax	(905) 567-8515	

## OWNER SERVICE ASSISTANCE

<b>Australia, Pacific</b>		
Telephone	(61) (3) 9791-5822	Mercury Marine Australia 132-140 Frankston Road Dandenong, Victoria 3164 Australia
Fax	(61) (3) 9793-5880	

<b>Europe, Middle East, Africa</b>		
Telephone	(32) (87) 32 • 32 • 11	Marine Power - Europe, Inc. Parc Industriel de Petit-Rechain B-4800 Verviers, Belgium
Fax	(32) (87) 31 • 19 • 65	

<b>Mexico, Central America, South America, Caribbean</b>		
Telephone	(954) 744-3513	Mercury Marine 11650 Interchange Circle North Miramar, FL 33025 U.S.A.
Fax	(954) 744-3535	

<b>Japan</b>		
Telephone	81-053-423-2500	Mercury Marine - Japan Anshin-cho 283-1 Hamamatsu Shizuoka-ken, Japan 435-0005 Japan
Fax	81-053-423-2510	

<b>Asia, Singapore</b>		
Telephone	5466160	Mercury Marine Singapore 72 Loyang Way Singapore, 508762
Fax	5467789	