

## Welcome Aboard!

Proper care and maintenance is an important part in keeping your Mercury Product operating at peak efficiency for maximum performance and economy. The enclosed Owner's Registration Card is your key to trouble-free family fun. Refer to your **Operation and Maintenance Manual** for full details of your warranty coverage.

Details of your nearest dealer can be found on [www.marinepower.com](http://www.marinepower.com) where country maps and full contact information are displayed.

Is your engine properly registered for warranty purpose? Please check on [www.marinepower.com](http://www.marinepower.com). If necessary, please contact your local dealer.

If the outboard motor's serial number plate contains the CE mark in the lower left-hand corner, the following statement applies:

This outboard motor manufactured by Mercury Marine, Fond du Lac, WI, USA or Marine Power Europe Inc. Park Industriel, de Petit-Rechain, Belgium complies with the requirements of the following directives and standards, as amended:

Recreational Craft Directive: 94/25/EC; std. ISO 8665, ISO 11547

Machinery Directive: 98/37/EC,

EMC Directive: 89/336/EC; std. EN50081-1, SAE J551 (CISPR Pub. 12),  
EN 50082-1, IEC 61000 PT4-2, IEC 61000 PT4-3



Patrick C. Mackey

President, Mercury Marine, Fond du Lac, WI USA

European Regulations Contact:

Product Environmental Engineering Department, Mercury Marine, Fond du Lac, WI USA

**EUROPEAN COMMUNITY DECLARATION OF CONFORMITY**  
**Issued in accordance with the**  
**MARINE EQUIPMENT DIRECTIVE (MED)**

This is to certify that in compliance with the Council Directive 96 / 98 / EC of 20 December 1996 on marine equipment, as amended by Commission Directives 98 / 85 / EC, 2001 / 53 / EC, 2002 / 75 / EC and Directive 2002 / 84 / EC of the European Parliament and of the Council :

**MARINE POWER EUROPE, Inc.**  
**Parc Industriel de Petit-Rechain**  
**B-4800 Verviers**  
**BELGIUM**

declares that the product(s) detailed below conform(s) to type as required by the above Directives as evidenced by the Conformity Route below :

EC Type Examination (Module B) Certificate N° *MED 0050424 (mercury)*  
N° *MED 0050421 (mariner)*  
issued November 17, 2000 by the Notified body (LRV N° = 0038)

&

EC (Module D) Certificate of Conformity N° *MED 0400010*  
issued March 23, 2004 by the Notified Body (LRV N° = 0038)

Manufacturer's Product            Code N° or type :    *Mercury and Mariner 40 hp 2cyl. (all versions)*  
Description :                    *Rescue Boat Propulsion Engine – Outboard Motor*  
Annex A.1 Item No. :    *A.1/1.37*

Applicable Testing Standards : **IMO Resolution MSC.81(70)**

Name : *Jacques BRONCHART*  
Title : *General Manager*  
Date : *9/8/04*

Signature

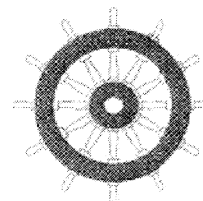

Test(s) outstanding / other actions required at ship (if any) \_\_\_\_\_

0038/YY (\*)

(\*) refers to the year of affixing the mark

**IMPORTANT NOTICE :**

In accordance with the above-mentioned certificate :

- 1 Each engine shall be fitted with the manufacturer's recommended propeller, which when fitted to a rescue boat, shall also be fitted with a guard.  
THE PROPELLER MAY NOT BE SUPPLIED AS FACTORY STANDARD EQUIPMENT.  
THE PROPELLER GUARD IS NOT SUPPLIED AS FACTORY STANDARD EQUIPMENT.
- 2 When supplied for use on Fast Rescue Boats on Ro-ro Passenger ships to which IMO MSC / Circ.809 Annex applies, for compliance with Annex paragraph 4.1.8. the engine is to be equipped with the facilities necessary to enable it to be re-started following a capsized.  
THESE FACILITIES ARE NOT SUPPLIED AS FACTORY STANDARD EQUIPMENT.

# TABLE OF CONTENTS

---

## Warranty Information

---

Transfer Of Warranty.....	1
Warranty Registration United States And Canada.....	1
Warranty Registration Outside The United States And Canada.....	1
Mercury Marine Two Years Limited Warranty (Europe).....	2
Mercury Marine One Year Limited Warranty (Confederation of Independent States, Middle-East, Africa).....	3
3 Year Limited Warranty Against Corrosion.....	5
Warranty Coverage And Exclusions.....	6

---

## GENERAL INFORMATION

---

Boater's Responsibilities.....	8
Before Operating Your Outboard.....	8
Boat Horsepower Capacity.....	8
High-Speed And High-Performance Boat Operation.....	9
Outboard Remote Control Models.....	9
Remote Steering Notice.....	9
Lanyard Stop Switch.....	10
Protecting People In The Water.....	11
Passenger Safety Message - Pontoon Boats And Deck Boats.....	11
Wave And Wake Jumping.....	12
Impact With Underwater Hazards.....	13
Safety Instructions For Hand Tilled Outboards.....	14
Exhaust Emissions.....	14
Selecting Accessories For Your Outboard.....	15
Safe Boating Suggestions.....	16
Recording Serial Number.....	16
40 Sea Pro/Marathon - 30/40 HP Specifications.....	17
Component Identification.....	18
40 SeaPro/Marathon Component Identification.....	19

---

## INSTALLATION

---

Installing Outboard.....	20
Propeller Selection.....	21

---

## TRANSPORTING

---

Trailing Boat/Outboard.....	22
Transporting Portable Fuel Tanks.....	22

---

## FUEL & OIL

---

Gasoline Recommendations.....	24
Oil Recommendation.....	24
Fuel and Oil Ratio.....	24
Mixing Fuel and Oil.....	25
Filling Oil Injection System.....	25

---

# TABLE OF CONTENTS

Filling Fuel Tank.....	26
------------------------	----

---

## FEATURES & CONTROLS

---

Remote Control Features.....	27
Warning System - Electric Start Models.....	27
Warning Horn System - Manual Start Models.....	28
Engine Over-Speed Limiter.....	29
Manual Tilt System.....	30
Power Trim And Tilt (if equipped).....	36
Throttle Grip Friction Adjustment - Tiller Handle Models.....	39
Steering Friction Adjustment.....	39
Trim Tab Adjustment.....	40

---

## OPERATION

---

Pre-Starting Check List.....	42
Operating In Freezing Temperatures.....	42
Operating In Salt Water Or Polluted Water.....	42
Operating at High Elevations.....	42
Engine Break-in Procedure.....	42
Starting The Engine - Electric Start Remote Control Models.....	43
Starting The Engine - Tiller Handle Models And Manual Start Remote Control Models.....	45
Gear Shifting.....	49
Stopping The Engine.....	49
Emergency Starting - Electric Start Models.....	50
Emergency Starting - Manual Start Models.....	52

---

## MAINTENANCE

---

Outboard Care.....	54
EPA Emissions.....	54
Inspection And Maintenance Schedule.....	55
Flushing The Cooling System.....	55
Top Cowl Removal And Installation.....	56
Battery Inspection.....	57
Fuel System.....	57
Exterior Care.....	61
Steering Link Rod Fasteners.....	61
Fuse Replacement - Electric Start Models.....	62
Corrosion Control Anode.....	63
Propeller Replacement.....	63
Spark Plug Inspection And Replacement.....	65
Lubrication Points.....	66
Checking Power Trim Fluid.....	68
Gearcase Lubrication.....	69
Submerged Outboard.....	70

---

## STORAGE

---

Storage Preparation.....	71
Protecting External Outboard Components.....	71

# TABLE OF CONTENTS

Protecting Internal Engine Components.....	71
Gearcase.....	71
Positioning Outboard For Storage.....	71
Battery Storage.....	72

---

## TROUBLESHOOTING

---

Starter Motor Will Not Crank The Engine (Electric Start Models).....	73
Engine Will Not Start.....	73
Engine Runs Erratically.....	73
Performance Loss.....	73
Battery Will Not Hold Charge.....	74

---

## OWNER SERVICE ASSISTANCE

---

Local Repair Service.....	75
Service Away From Home.....	75
Parts And Accessories Inquiries.....	75
Service Assistance.....	75
Mercury Marine Service Offices.....	75

# WARRANTY INFORMATION

## Transfer Of Warranty

The limited warranty is transferable to a subsequent purchaser, but only for the remainder of the unused portion of the limited warranty. This will not apply to products used for commercial applications.

To transfer the warranty to the subsequent owner, send or fax a copy of the bill of sale or purchase agreement, new owner's name, address and engine serial number to Mercury Marine's warranty registration department.

Mercury Marine  
Attn: Warranty Registration Department  
W6250 W. Pioneer Road  
P.O. Box 1939  
Fond du Lac, WI 54936-1939  
920-929-5054

Upon processing the transfer of warranty, Mercury Marine will send registration verification to the new owner of the product by mail.

There is no charge for this service.

For products purchased outside the United States and Canada, contact the distributor in your country, or the Mercury Marine Service Office closest to you.

## Warranty Registration United States And Canada

1. You may change your address at any time, including at time of warranty claim, by calling Mercury Marine or sending a letter or fax with your name, old address, new address, and engine serial number to Mercury Marine's warranty registration department. Your dealer can also process this change of information.

Mercury Marine  
Attn: Warranty Registration Department  
W6250 W. Pioneer Road  
P.O. Box 1939  
Fond du Lac, WI 54936-1939  
920-929-5054

**NOTE:** Registration lists must be maintained by Mercury Marine and any dealer on marine products sold in the United States, should a safety recall notification under the Federal Safety Act be required.

2. To be eligible for warranty coverage, the product must be registered with Mercury Marine. At the time of sale, the dealer should complete the warranty registration and immediately submit it to Mercury Marine via MercNET, E-mail, or mail. Upon receipt of this warranty registration, Mercury Marine will record the registration.
3. Upon processing the warranty registration, Mercury Marine will send registration verification by mail to the purchaser of the product. If this registration verification is not received within 30 days, please contact your selling dealer immediately. Warranty coverage is not effective until your product is registered with Mercury Marine.

## Warranty Registration Outside The United States And Canada

1. It is important that your selling dealer fills out the Warranty Registration Card completely and mails it to the distributor or Marine Power Service Center responsible for administering the warranty registration/claim program for your area.
2. The Warranty Registration Card identifies your name and address, product model and serial numbers, date of sale, type of use and the selling distributor's/dealer's code number, name and address. The distributor/dealer also certifies that you are the original purchaser and user of the product.
3. A copy of the Warranty Registration Card, designated as the Purchaser's Copy, MUST be given to you immediately after the card has been completely filled out by the selling distributor/dealer. This card represents your factory registration identification, and should be retained by you for future use when required. Should you ever require warranty service on this product, your dealer may ask you for the Warranty Registration Card to verify date of purchase and to use the information on the card to prepare the warranty claim forms.

# WARRANTY INFORMATION

4. In some countries, the Marine Power Service Center will issue you a permanent (plastic) Warranty Registration Card within 30 days after receiving the Factory Copy of the Warranty Registration Card from your distributor/dealer. If you receive a plastic Warranty Registration Card, you may discard the Purchaser's Copy that you received from the distributor/dealer when you purchased the product. Ask your distributor/dealer if this plastic card program applies to you.

**IMPORTANT: Registration lists must be maintained by the factory and dealer in some countries by law. It is our desire to have ALL products registered at the factory should it ever be necessary to contact you. Make sure your dealer/distributor fills out the warranty registration card immediately and sends the factory copy to the Marine Power International Service Center for your area.**

5. For further information concerning the Warranty Registration Card and its relationship to Warranty Claim processing, refer to the International Warranty.

## Mercury Marine Two Years Limited Warranty (Europe)

**WHAT IS COVERED:** Mercury Marine warrants each new Mercury Outboard, Mariner Outboard, Jet Products, Thruster Electric Trolling Motors, Mercruiser Inboard or Sterndrive engine products to be free of defects in material and workmanship during the period described below.

**DURATION OF COVERAGE:** This Limited Warranty provides coverage for two (2) years from the date the product is first sold to a recreational use retail purchaser, or the date on which the product is first put into service, whichever occurs first. Commercial users of these products receive warranty coverage of two (2) years from the date of first retail sale, or the accumulation of 500 hours of operation, whichever occurs first. Commercial use is defined as any work or employment related use of the product, or any use of the product which generates income, for any part of the warranty period, even if the product is only occasionally used for such purposes. The repair or replacement of parts, or the performance of service under this warranty, does not extend the life of this warranty beyond its original expiration date. Unexpired warranty coverage can be transferred to one recreational use to a subsequent recreational use customer upon proper re-registration of the product.

**CONDITIONS THAT MUST BE MET IN ORDER TO OBTAIN WARRANTY COVERAGE:** Warranty coverage is available only to retail customers that purchase from a Dealer authorized by Mercury Marine to distribute the product in the country in which the sale occurred, and then only after the Mercury Marine specified pre-delivery inspection process is completed and documented. Warranty coverage becomes available upon proper registration of the product by the authorized dealer. Inaccurate warranty registration information regarding recreational use, or subsequent change of use from recreational to commercial (unless properly re-registered) may void the warranty at the sole discretion of Mercury Marine. Routine maintenance outlined in the Operation and Maintenance Manual must be timely performed in order to maintain warranty coverage. If this maintenance is performed by the retail customer Mercury Marine reserves the right to make future warranty coverage contingent on proof of proper maintenance.

**WHAT MERCURY WILL DO:** Mercury's sole and exclusive obligation under this warranty is limited to, at our option, repairing a defective part, replacing such part or parts with new or Mercury Marine certified re-manufactured parts, or refunding the purchase price of the Mercury product. Mercury reserves the right to improve or modify products from time to time without assuming an obligation to modify products previously manufactured.

**HOW TO OBTAIN WARRANTY COVERAGE:** The customer must provide Mercury with a reasonable opportunity to repair, and reasonable access to the product for warranty service. Warranty claims shall be made by delivering the product for inspection to a Mercury dealer authorized to service the product. If purchaser cannot deliver the product to such a dealer, written notice must be given to Mercury. We will then arrange for the inspection and any covered repair. Purchaser in that case shall pay for all related transportation charges and/or travel time. If the service provided is not covered by this warranty, purchaser shall pay for all related labor and material, and any other expenses associated with that service. Purchaser shall not, unless requested by Mercury, ship the product or parts of the product directly to Mercury. The warranty registration card is the only valid registration identification and must be presented to the dealer at the time warranty service is requested in order to obtain coverage.

# WARRANTY INFORMATION

**WHAT IS NOT COVERED:** This limited warranty does not cover routine maintenance items, tune ups, adjustments, normal wear and tear, damage caused by abuse, abnormal use, use of a propeller or gear ratio that does not allow the engine to run in its recommended wide open throttle RPM range (see the Operation and Maintenance Manual), operation of the product in a manner inconsistent with the recommended operation/duty cycle section of the Operation and Maintenance Manual, neglect, accident, submersion, improper installation (proper installation specifications and techniques are set forth in the installation instructions for the product), improper service, use of an accessory or part not manufactured or sold by us, jet pump impellers and liners, operation with fuels, oils or lubricants which are not suitable for use with the product (see the Operation and Maintenance Manual), alteration or removal of parts, or water entering the engine through the fuel intake, air intake or exhaust system. Use of the product for racing or other competitive activity, or operating with a racing type lower unit, at any point, even by a prior owner of the product, voids the warranty.

Expenses related to haul out, launch, towing, storage, telephone, rental, inconvenience, slip fees, insurance coverage, loan payments, loss of time, loss of income, or any other type of incidental or consequential damages are not covered by this warranty. Also, expenses associated with the removal and/or replacement of boat partitions or material caused by boat design for access to the product are not covered by this warranty.

No individual or entity, including Mercury Marine authorized dealers, has been given authority by Mercury Marine to make any affirmation, representation or warranty regarding the product, other than those contained in this limited warranty, and if made, shall not be enforceable against Mercury Marine.

For additional information regarding events and circumstances covered by this warranty, and those that are not, see the Warranty Coverage section of the Operation and Maintenance Manual, incorporated by reference into this warranty.

## DISCLAIMERS AND LIMITATIONS:

THE IMPLIED WARRANTIES OF MERCHANTABILITY AND FITNESS FOR A PARTICULAR PURPOSE ARE EXPRESSLY DISCLAIMED. TO THE EXTENT THAT THEY CANNOT BE DISCLAIMED, THE IMPLIED WARRANTIES ARE LIMITED IN DURATION TO THE LIFE OF THE EXPRESS WARRANTY. INCIDENTAL AND CONSEQUENTIAL DAMAGES ARE EXCLUDED FROM COVERAGE UNDER THIS WARRANTY. SOME STATES/COUNTRIES DO NOT ALLOW FOR THE DISCLAIMERS, LIMITATIONS AND EXCLUSIONS IDENTIFIED ABOVE, AS A RESULT, THEY MAY NOT APPLY TO YOU. THIS WARRANTY GIVES YOU SPECIFIC LEGAL RIGHTS, AND YOU MAY ALSO HAVE OTHER LEGAL RIGHTS WHICH VARY FROM STATE TO STATE AND COUNTRY TO COUNTRY.

## Mercury Marine One Year Limited Warranty (Confederation of Independent States, Middle-East, Africa)

**WHAT IS COVERED:** Mercury Marine warrants each new Mercury outboard, Mariner outboard, Jet Products, Thruster Electric Trolling Motors, Mercruiser Inboard or Sterndrive engine products to be free of defects in material and workmanship during the period described below.

**DURATION OF COVERAGE:** This Limited Warranty provides coverage for one (1) year from the date the product is first sold to a recreational use retail purchaser, or the date on which the product is first put into service, whichever occurs first. Commercial users of these products receive warranty coverage of one (1) years from the date of first retail sale, or the accumulation of 500 hours of operation, whichever occurs first. Commercial use is defined as any work or employment related use of the product, or any use of the product which generates income, for any part of the warranty period, even if the product is only occasionally used for such purposes. The repair or replacement of parts, or the performance of service under this warranty, does not extend the life of this warranty beyond its original expiration date. Unexpired warranty coverage can be transferred to a subsequent purchaser upon proper re-registration of the product.



# WARRANTY INFORMATION

**CONDITIONS THAT MUST BE MET IN ORDER TO OBTAIN WARRANTY COVERAGE:** Warranty coverage is available only to retail customers that purchase from a Dealer authorized by Mercury Marine to distribute the product in the country in which the sale occurred, and then only after the Mercury Marine specified pre-delivery inspection process is completed and documented. Warranty coverage becomes available upon proper registration of the product by the authorized dealer. Inaccurate warranty registration information regarding recreational use, or subsequent change of use from recreational to commercial (unless properly re-registered) may void the warranty at the sole discretion of Mercury Marine. Routine maintenance outlined in the Operation and Maintenance Manual must be timely performed in order to maintain warranty coverage. If this maintenance is performed by the retail customer Mercury Marine reserves the right to make future warranty coverage contingent on proof of proper maintenance.

**WHAT MERCURY WILL DO:** Mercury's sole and exclusive obligation under this warranty is limited to, at our option, repairing a defective part, replacing such part or parts with new or Mercury Marine certified re-manufactured parts, or refunding the purchase price of the Mercury product. Mercury reserves the right to improve or modify products from time to time without assuming an obligation to modify products previously manufactured.

**HOW TO OBTAIN WARRANTY COVERAGE:** The customer must provide Mercury with a reasonable opportunity to repair, and reasonable access to the product for warranty service. Warranty claims shall be made by delivering the product for inspection to a Mercury dealer authorized to service the product. If purchaser cannot deliver the product to such a dealer, written notice must be given to Mercury. We will then arrange for the inspection and any covered repair. Purchaser in that case shall pay for all related transportation charges and/or travel time. If the service provided is not covered by this warranty, purchaser shall pay for all related labor and material, and any other expenses associated with that service. Purchaser shall not, unless requested by Mercury, ship the product or parts of the product directly to Mercury. The warranty registration card is the only valid registration identification and must be presented to the dealer at the time warranty service is requested in order to obtain coverage.

**WHAT IS NOT COVERED:** This limited warranty does not cover routine maintenance items, tune ups, adjustments, normal wear and tear, damage caused by abuse, abnormal use, use of a propeller or gear ratio that does not allow the engine to run in its recommended wide open throttle RPM range (see the Operation and Maintenance Manual), operation of the product in a manner inconsistent with the recommended operation/duty cycle section of the Operation and Maintenance Manual, neglect, accident, submersion, improper installation (proper installation specifications and techniques are set forth in the installation instructions for the product), improper service, use of an accessory or part not manufactured or sold by us, jet pump impellers and liners, operation with fuels, oils or lubricants which are not suitable for use with the product (see the Operation and Maintenance Manual), alteration or removal of parts, or water entering the engine through the fuel intake, air intake or exhaust system. Use of the product for racing or other competitive activity, or operating with a racing type lower unit, at any point, even by a prior owner of the product, voids the warranty.

Expenses related to haul out, launch, towing, storage, telephone, rental, inconvenience, slip fees, insurance coverage, loan payments, loss of time, loss of income, or any other type of incidental or consequential damages are not covered by this warranty. Also, expenses associated with the removal and/or replacement of boat partitions or material caused by boat design for access to the product are not covered by this warranty.

No individual or entity, including Mercury Marine authorized dealers, has been given authority by Mercury Marine to make any affirmation, representation or warranty regarding the product, other than those contained in this limited warranty, and if made, shall not be enforceable against Mercury Marine.

For additional information regarding events and circumstances covered by this warranty, and those that are not, see the Warranty Coverage section of the Operation and Maintenance Manual, incorporated by reference into this warranty.

# WARRANTY INFORMATION

## DISCLAIMERS AND LIMITATIONS:

THE IMPLIED WARRANTIES OF MERCHANTABILITY AND FITNESS FOR A PARTICULAR PURPOSE ARE EXPRESSLY DISCLAIMED. TO THE EXTENT THAT THEY CANNOT BE DISCLAIMED, THE IMPLIED WARRANTIES ARE LIMITED IN DURATION TO THE LIFE OF THE EXPRESS WARRANTY. INCIDENTAL AND CONSEQUENTIAL DAMAGES ARE EXCLUDED FROM COVERAGE UNDER THIS WARRANTY. SOME STATES/COUNTRIES DO NOT ALLOW FOR THE DISCLAIMERS, LIMITATIONS AND EXCLUSIONS IDENTIFIED ABOVE, AS A RESULT, THEY MAY NOT APPLY TO YOU. THIS WARRANTY GIVES YOU SPECIFIC LEGAL RIGHTS, AND YOU MAY ALSO HAVE OTHER LEGAL RIGHTS WHICH VARY FROM STATE TO STATE AND COUNTRY TO COUNTRY.

## 3 Year Limited Warranty Against Corrosion

**WHAT IS COVERED:** Mercury Marine warrants that each new Mercury, Mariner, Mercury Racing, Sport Jet, M<sup>2</sup> Jet Drive, Tracker by Mercury Marine Outboard, MerCruiser Inboard or sterndrive engine (Product) will not be rendered inoperative as a direct result of corrosion for the period of time described below.

**DURATION OF COVERAGE:** This limited corrosion warranty provides coverage for three (3) years from either the date the product is first sold, or the date on which the product is first put into service, whichever occurs first. The repair or replacement of parts, or the performance of service under this warranty does not extend the life of this warranty beyond its original expiration date. Unexpired warranty coverage can be transferred to subsequent (non-commercial use) purchaser upon proper re-registration of the product.

**CONDITIONS THAT MUST BE MET IN ORDER TO OBTAIN WARRANTY COVERAGE:** Warranty coverage is available only to retail customers that purchase from a Dealer authorized by Mercury Marine to distribute the product in the country in which the sale occurred, and then only after the Mercury Marine specified pre-delivery inspection process is completed and documented. Warranty coverage becomes available upon proper registration of the product by the authorized dealer. Corrosion prevention devices specified in the Operation and Maintenance Manual must be in use on the boat, and routine maintenance outlined in the Operation and Maintenance Manual must be timely performed (including without limitation the replacement of sacrificial anodes, use of specified lubricants, and touch-up of nicks and scratches) in order to maintain warranty coverage. Mercury Marine reserves the right to make warranty coverage contingent upon proof of proper maintenance.

**WHAT MERCURY WILL DO:** Mercury's sole and exclusive obligation under this warranty is limited to, at our option, repairing a corroded part, replacing such part or parts with new or Mercury Marine certified re-manufactured parts, or refunding the purchase price of the Mercury product. Mercury reserves the right to improve or modify products from time to time without assuming an obligation to modify products previously manufactured.

**HOW TO OBTAIN WARRANTY COVERAGE:** The customer must provide Mercury with a reasonable opportunity to repair, and reasonable access to the product for warranty service. Warranty claims shall be made by delivering the product for inspection to a Mercury dealer authorized to service the product. If purchaser cannot deliver the product to such a dealer, written notice must be given to Mercury. We will then arrange for the inspection and any covered repair. Purchaser in that case shall pay for all related transportation charges and/or travel time. If the service provided is not covered by this warranty, purchaser shall pay for all related labor and material, and any other expenses associated with that service. Purchaser shall not, unless requested by Mercury, ship the product or parts of the product directly to Mercury. Proof of registered ownership must be presented to the dealer at the time warranty service is requested in order to obtain coverage.

**WHAT IS NOT COVERED:** This limited warranty does not cover electrical system corrosion; corrosion resulting from damage, corrosion which causes purely cosmetic damage, abuse or improper service; corrosion to accessories, instruments, steering systems; corrosion to factory installed jet drive unit; damage due to marine growth; product sold with less than a one year limited Product warranty; replacement parts (parts purchased by customer); products used in a commercial application. Commercial use is defined as any work or employment related use of the product, or any use of the product which generates income, for any part of the warranty period, even if the product is only occasionally used for such purposes.

# WARRANTY INFORMATION

Corrosion damage caused by stray electrical currents (on-shore power connections, nearby boats, submerged metal) is not covered by this corrosion warranty and should be protected against by the use of a corrosion protection system, such as the Mercury Precision Parts or Quicksilver MerCathode system and/or Galvanic Isolator. Corrosion damage caused by improper application of copper base anti-fouling paints is also not covered by this limited warranty. If anti-fouling protection is required, Tri-Butyl-Tin-Adipate (TBTA) base anti-fouling paints are recommended on Outboard and MerCruiser boating applications. In areas where TBTA base paints are prohibited by law, copper base paints can be used on the hull and transom. Do not apply paint to the outboard or MerCruiser product. In addition, care must be taken to avoid an electrical interconnection between the warranted product and the paint. For MerCruiser product, an unpainted gap of at least 38 mm (1.5 in.) should be left around the transom assembly. Refer to the Operation and Maintenance Manual for additional details.

For additional information regarding events and circumstances covered by this warranty, and those that are not, see the Warranty Coverage section of the Operation and Maintenance Manual, incorporated by reference into this warranty.

## **DISCLAIMERS AND LIMITATIONS:**

**THE IMPLIED WARRANTIES OF MERCHANTABILITY AND FITNESS FOR A PARTICULAR PURPOSE ARE EXPRESSLY DISCLAIMED. TO THE EXTENT THAT THEY CANNOT BE DISCLAIMED, THE IMPLIED WARRANTIES ARE LIMITED IN DURATION TO THE LIFE OF THE EXPRESS WARRANTY. INCIDENTAL AND CONSEQUENTIAL DAMAGES ARE EXCLUDED FROM COVERAGE UNDER THIS WARRANTY. SOME STATES/COUNTRIES DO NOT ALLOW FOR THE DISCLAIMERS, LIMITATIONS AND EXCLUSIONS IDENTIFIED ABOVE, AS A RESULT, THEY MAY NOT APPLY TO YOU. THIS WARRANTY GIVES YOU SPECIFIC LEGAL RIGHTS, AND YOU MAY ALSO HAVE OTHER LEGAL RIGHTS WHICH VARY FROM STATE TO STATE AND COUNTRY TO COUNTRY.**

## Warranty Coverage And Exclusions

The purpose of this section is to help eliminate some of the more common misunderstandings regarding warranty coverage. The following information explains some of the types of services that are not covered by warranty. The provisions set forth following have been incorporated by reference into the Three Year Limited Warranty Against Corrosion Failure, the International Limited Outboard Warranty, and the United States and Canada Limited Outboard Warranty.

Keep in mind that warranty covers repairs that are needed within the warranty period because of defects in material and workmanship. Installation errors, accidents, normal wear, and a variety of other causes that affect the product are not covered.

Warranty is limited to defects in material or workmanship, but only when the consumer sale is made in the country to which distribution is authorized by us.

Should you have any questions concerning warranty coverage, contact your authorized dealer. They will be pleased to answer any questions that you may have.

## GENERAL EXCLUSIONS FROM WARRANTY

1. Minor adjustments and tune-ups, including checking, cleaning or adjusting spark plugs, ignition components, carburetor settings, filters, belts, controls, and checking lubrication made in connection with normal services.
2. Factory installed jet drive units - Specific parts excluded from the warranty are: The jet drive impeller and jet drive liner damaged by impact or wear, and water damaged drive shaft bearings as a result of improper maintenance.
3. Damage caused by neglect, lack of maintenance, accident, abnormal operation or improper installation or service.
4. Haul out, launch, towing charges, removal and/or replacement of boat partitions or material because of boat design for necessary access to the product, all related transportation charges and/or travel time, etc. Reasonable access must be provided to the product for warranty service. Customer must deliver product to an authorized dealer.
5. Additional service work requested by customer other than that necessary to satisfy the warranty obligation.

# WARRANTY INFORMATION

6. Labor performed by other than an authorized dealer may be covered only under following circumstances: When performed on emergency basis (providing there are no authorized dealers in the area who can perform the work required or have no facilities to haul out, etc., and prior factory approval has been given to have the work performed at this facility).
7. All incidental and/or consequential damages (storage charges, telephone or rental charges of any type, inconvenience or loss of time or income) are the owner's responsibility.
8. Use of other than Mercury Precision or Quicksilver parts when making warranty repairs.
9. Oils, lubricants or fluids changed as a matter of normal maintenance is customer's responsibility unless loss or contamination of same is caused by product failure that would be eligible for warranty consideration.
10. Participating in or preparing for racing or other competitive activity or operating with a racing type lower unit.
11. Engine noise does not necessarily indicate a serious engine problem. If diagnosis indicates a serious internal engine condition which could result in a failure, condition responsible for noise should be corrected under the warranty.
12. Lower unit and/or propeller damage caused by striking a submerged object is considered a marine hazard.
13. Water entering engine through the fuel intake, air intake or exhaust system or submersion.
14. Failure of any parts caused by lack of cooling water, which results from starting motor out of water, foreign material blocking inlet holes, motor being mounted too high or trimmed too far out.
15. Use of fuels and lubricants which are not suitable for use with or on the product. Refer to the **Maintenance** section.
16. Our limited warranty does not apply to any damage to our products caused by the installation or use of parts and accessories which are not manufactured or sold by us. Failures which are not related to the use of those parts or accessories are covered under warranty if they otherwise meet the terms of the limited warranty for that product.

# GENERAL INFORMATION

## Boater's Responsibilities

The operator (driver) is responsible for the correct and safe operation of the boat and safety of its occupants and general public. It is strongly recommended that each operator (driver) read and understand this entire manual before operating the outboard.

Be sure at least one additional person on board is instructed in the basics of starting and operating the outboard and boat handling in case the driver is unable to operate the boat.

## Before Operating Your Outboard

Read this manual carefully. Learn how to operate your outboard properly. If you have any questions, contact your dealer.

Safety and operating information that is practiced, along with using good common sense, can help prevent personal injury and product damage.

This manual as well as safety labels posted on the outboard use the following safety alerts to draw your attention to special safety instructions that should be followed.

### **DANGER**

**DANGER** - indicates an imminently hazardous situation that, if not avoided, will result in death or serious injury.

### **WARNING**

**WARNING** - indicates a potentially hazardous situation that, if not avoided, could result in death or serious injury.

### **CAUTION**

**CAUTION** - indicates a potentially hazardous situation that, if not avoided, may result in minor or moderate injury or property damage. It may also be used to alert against unsafe practices.

## Boat Horsepower Capacity

### **WARNING**

Using an outboard that exceeds the maximum horsepower limit of a boat can: 1) cause loss of boat control 2) place too much weight at the transom altering the designed flotation characteristics of the boat or 3) cause the boat to break apart particularly around the transom area. Overpowering a boat can result in serious injury, death or boat damage.

Do not overpower or overload your boat. Most boats will carry a required capacity plate indicating the maximum acceptable power and load as determined by the manufacturer following certain federal guidelines. If in doubt, contact your dealer or the boat manufacturer.

# GENERAL INFORMATION

U.S. COAST GUARD CAPACITY	
MAXIMUM HORSEPOWER	XXX
MAXIMUM PERSON CAPACITY (POUNDS)	XXX
MAXIMUM WEIGHT CAPACITY	XXX

ob00306

## High-Speed And High-Performance Boat Operation

If your outboard is to be used on a high speed or high performance boat with which you are unfamiliar, we recommend that you never operate it at its high speed capability without first requesting an initial orientation and familiarization demonstration ride with your dealer or an operator experienced with your boat/outboard combination. For additional information, obtain a copy of our **Hi-Performance Boat Operation** booklet (part number 90-849250--1) from your dealer, distributor, or Mercury Marine.



ob00307

## Outboard Remote Control Models

The remote control connected to your outboard must be equipped with a start in neutral only protection device. This prevents the engine from starting when the shift is actuated in any position other than neutral.

### WARNING

Avoid serious injury or death from a sudden unexpected acceleration when starting your engine. The design of this outboard requires that the remote control used with it must have a built in start in neutral only protection device.

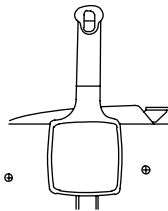

ob00308

## Remote Steering Notice

### WARNING

Disengagement of a steering link rod can result in the boat taking a full, sudden, sharp turn. This potentially violent action can cause occupants to be thrown overboard exposing them to serious injury or death.

# GENERAL INFORMATION

The steering link rod that connects the steering cable to the engine must be fastened utilizing self-locking nuts. These self-locking nuts must never be replaced with common nuts (non-locking) as they will work loose and vibrate off, freeing the link rod to disengage.

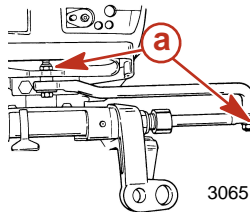

a - Self-locking nuts

## Lanyard Stop Switch

The purpose of a lanyard stop switch is to turn off the engine when the operator moves far enough away from the operator's position (as in accidental ejection from the operator's position) to activate the switch. Tiller handle outboards and some remote control units are equipped with a lanyard stop switch. A lanyard stop switch can be installed as an accessory - generally on the dashboard or side adjacent to the operator's position.

The lanyard is a cord usually between 122 and 152 cm (4 and 5 feet) in length when stretched out, with an element on one end made to be inserted into the switch and a snap on the other end for attaching to the operator. The lanyard is coiled to make its at-rest condition as short as possible to minimize the likelihood of lanyard entanglement with nearby objects. Its stretched-out length is made to minimize the likelihood of accidental activation should the operator choose to move around in an area close to the normal operator's position. If it is desired to have a shorter lanyard, wrap the lanyard around the operator's wrist or leg, or tie a knot in the lanyard.

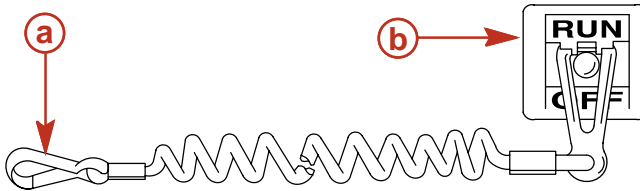

a - Lanyard cord

b - Lanyard stop switch

Read the following Safety Information before proceeding.

**Important Safety Information:** The purpose of a lanyard stop switch is to stop the engine when the operator moves far enough away from the operator's position to activate the switch. This would occur if the operator accidentally falls overboard or moves within the boat a sufficient distance from the operator's position. Falling overboard and accidental ejections are more likely to occur in certain types of boats such as low sided inflatables, bass boats, high performance boats, and light, sensitive handling fishing boats operated by a hand tiller. Falling overboard and accidental ejections are also likely to occur as a result of poor operating practices such as sitting on the back of the seat or gunwale at planing speeds, standing at planing speeds, sitting on elevated fishing boat decks, operating at planing speeds in shallow or obstacle infested waters, releasing your grip on a steering wheel or tiller handle that is pulling in one direction, drinking alcohol or consuming drugs, or daring high speed boat maneuvers.

While activation of the lanyard stop switch will stop the engine immediately, a boat will continue to coast for some distance depending upon the velocity and degree of any turn at shut down. However, the boat will not complete a full circle. While the boat is coasting, it can cause injury to anyone in the boat's path as seriously as the boat would when under power.

We strongly recommend that other occupants be instructed on proper starting and operating procedures should they be required to operate the engine in an emergency (e.g. if the operator is accidentally ejected).

# GENERAL INFORMATION

## **⚠ WARNING**

Should the operator fall out of the boat, the possibility of serious injury or death from being run over by the boat can be greatly reduced by stopping the engine immediately. Always properly connect both ends of the stop switch lanyard to the stop switch and the operator.

## **⚠ WARNING**

Avoid serious injury or death from deceleration forces resulting from accidental or unintended stop switch activation. The boat operator should never leave the operator's station without first disconnecting the stop switch lanyard from the operator.

Accidental or unintended activation of the switch during normal operation is also a possibility. This could cause any, or all, of the following potentially hazardous situations:

- Occupants could be thrown forward due to unexpected loss of forward motion - a particular concern for passengers in the front of the boat who could be ejected over the bow and possibly struck by the gearcase or propeller.
- Loss of power and directional control in heavy seas, strong current or high winds.
- Loss of control when docking.

## Protecting People In The Water

### WHILE YOU ARE CRUISING

It is very difficult for a person standing or floating in the water to take quick action to avoid a boat heading in his/her direction, even at slow speed.



ob00311

Always slow down and exercise extreme caution any time you are boating in an area where there might be people in the water.

Whenever a boat is moving (coasting) and the outboard gear shift is in neutral position, there is sufficient force by the water on the propeller to cause the propeller to rotate. This neutral propeller rotation can cause serious injury.

### WHILE BOAT IS STATIONARY

## **⚠ WARNING**

Stop your engine immediately whenever anyone in the water is near your boat. Serious injury to the person in the water is likely if contacted by a rotating propeller, a moving boat, a moving gearcase, or any solid device rigidly attached to a moving boat or gearcase.

Shift outboard into neutral and shut off the engine before allowing people to swim or be in the water near your boat.

## Passenger Safety Message - Pontoon Boats And Deck Boats

Whenever the boat is in motion, observe the location of all passengers. Do not allow any passengers to stand or use seats other than those designated for traveling faster than idle speed. A sudden reduction in boat speed, such as plunging into a large wave or wake, a sudden throttle reduction, or a sharp change of boat direction, could throw them over the front of boat. Falling over the front of the boat between the two pontoons will position them to be run over by the outboard.



# GENERAL INFORMATION

## BOATS HAVING AN OPEN FRONT DECK

No one should ever be on the deck in front of the fence while the boat is in motion. Keep all passengers behind the front fence or enclosure.

Persons on the front deck could easily be thrown overboard or persons dangling their feet over the front edge could get their legs caught by a wave and pulled into the water.

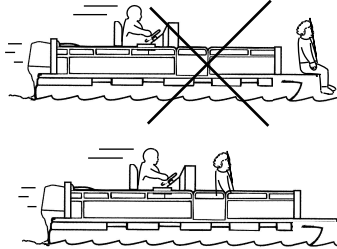

ob00312

### **WARNING**

**Avoid serious injury or death from falling over the front end of a pontoon or deck boat and being run over by the outboard. Stay back from the front end of the deck and remain seated while the boat is in motion.**

## BOATS WITH FRONT MOUNTED, RAISED PEDESTAL FISHING SEATS

Elevated fishing seats are not intended for use when the boat is traveling faster than idle or trolling speed. Sit only in seats designated for traveling at faster speeds.

Any unexpected, sudden reduction in boat speed could result in the elevated passenger falling over the front of the boat.

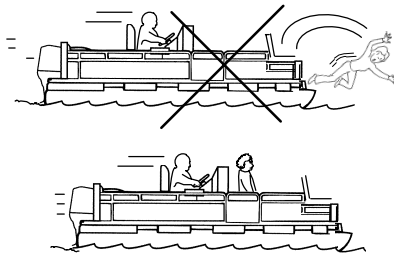

ob00313

## Wave And Wake Jumping

Operating recreational boats over waves and wake is a natural part of boating. However, when this activity is done with sufficient speed to force the boat hull partially or completely out of the water, certain hazards arise, particularly when the boat re-enters the water.

# GENERAL INFORMATION

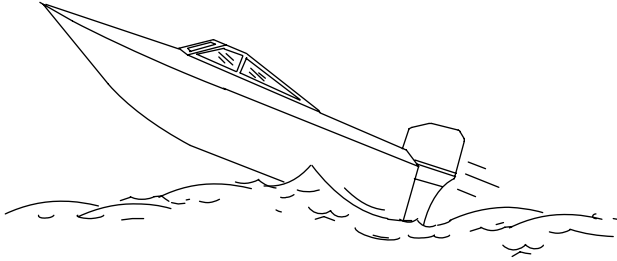

ob00314

The primary concern is the boat changing direction while in the midst of the jump. In such case the landing may cause the boat to veer violently in a new direction. Such a sharp change in direction can cause occupants to be thrown out of their seats, or out of the boat.

## WARNING

**Avoid serious injury or death from being thrown within or out of a boat when it lands after jumping a wave or wake. Avoid wave or wake jumping whenever possible. Instruct all occupants that if a wake or wave jump occurs, get low and hang on to a boat hand hold.**

There is another less common hazardous result from allowing your boat to launch off a wave or wake. If the bow of your boat pitches down far enough while airborne, upon water contact it may penetrate under the water surface and submarine for an instant. This will bring the boat to a nearly instantaneous stop and can send the occupants flying forward. The boat may also steer sharply to one side.

## Impact With Underwater Hazards

Reduce speed and proceed with caution whenever you drive a boat in shallow water areas, or in areas where you suspect underwater obstacles may exist which could be struck by the outboard or the boat bottom. **The most important thing you can do to help reduce injury or impact damage from striking a floating or underwater object is to control the boat speed. Under these conditions, boat speed should be kept to a minimum planing speed 24 to 40 km/h (15 to 25 MPH) .**

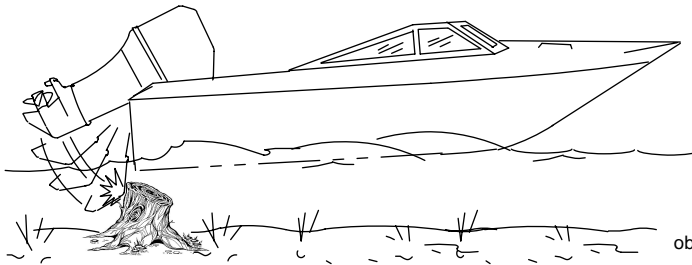

ob00315

## WARNING

**To avoid serious injury or death from all or part of an outboard coming into the boat after striking a floating or underwater obstacle maintain a top speed no greater than minimum planing speed.**

Striking a floating or underwater object could result in an infinite number of situations. Some of these situations could result in the following:

- Part of the outboard or the entire outboard could break loose and fly into the boat.
- The boat could move suddenly in a new direction. Such a sharp change in direction can cause occupants to be thrown out of their seats or out of the boat.

# GENERAL INFORMATION

- A rapid reduction in speed. This will cause occupants to be thrown forward, or even out of the boat.
- Impact damage to the outboard and/or boat.

Keep in mind, the most important thing you can do to help reduce injury or impact damage during an impact is control the boat speed. Boat speed should be kept to a minimum planing speed when driving in waters known to have underwater obstacles.

After striking a submerged object, stop the engine as soon as possible and inspect it for any broken or loose parts. If damage is present or suspected, the outboard should be taken to an authorized dealer for a thorough inspection and necessary repair.

The boat should also be checked for any hull fractures, transom fractures, or water leaks.

Operating a damaged outboard could cause additional damage to other parts of the outboard, or could affect control of the boat. If continued running is necessary, do so at greatly reduced speeds.

## WARNING

**Avoid serious injury or death from loss of boat control. Continued boating with major impact damage can result in sudden outboard component failure with or without subsequent impacts. Have the outboard thoroughly inspected and any necessary repairs made.**

## Safety Instructions For Hand Tilted Outboards

No person or cargo should occupy the area directly in front of the outboard while the boat is in motion. If an underwater obstacle is struck, the outboard will tilt up and could seriously injure anyone occupying this area.

### MODELS WITH CLAMP SCREWS:

Some outboards come with transom bracket clamp screws. The use of clamp bracket screws alone, is insufficient to properly and safely secure the outboard to the transom. Proper installation of the outboard includes bolting the engine to the boat through the transom. Refer to **Installation - Installing Outboard** for more complete installation information.

## WARNING

**Avoid serious injury or death from being struck by a disconnected outboard. Do not accelerate above idle speed in water suspected of containing underwater obstacles if the outboard is not attached to the transom correctly.**

If an obstacle is struck at planing speed and the outboard is not securely fastened to the transom, it is possible the outboard could lift off the transom and land in the boat.

## Exhaust Emissions

### BE ALERT TO CARBON MONOXIDE POISONING

Carbon monoxide is present in the exhaust fumes of all internal combustion engines. This includes the outboards, sterndrives and inboard engines that propel boats, as well as the generators that power various boat accessories. Carbon monoxide is a deadly gas that is odorless, colorless and tasteless.

Early symptoms of carbon monoxide poisoning which should not be confused with seasickness or intoxication, include headache, dizziness, drowsiness, and nausea.

## WARNING

**Avoid the combination of a running engine and poor ventilation. Prolonged exposure to carbon monoxide in sufficient concentration can lead to unconsciousness, brain damage, or death.**

### GOOD VENTILATION

Ventilate passenger area, open side curtains, or forward hatches to remove fumes.

# GENERAL INFORMATION

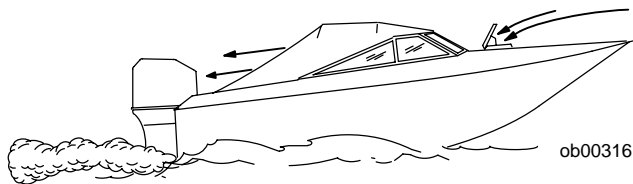

ob00316

Example of desired air flow through the boat.

## POOR VENTILATION

Under certain running and/or wind conditions, permanently enclosed or canvas enclosed cabins or cockpits with insufficient ventilation may draw in carbon monoxide. Install one or more carbon monoxide detectors in your boat.

Although the occurrence is rare, on a very calm day, swimmers and passengers in an enclosed area of a stationary boat that contains or is near a running engine may be exposed to a hazardous level of carbon monoxide.

## WHILE BOAT IS STATIONARY

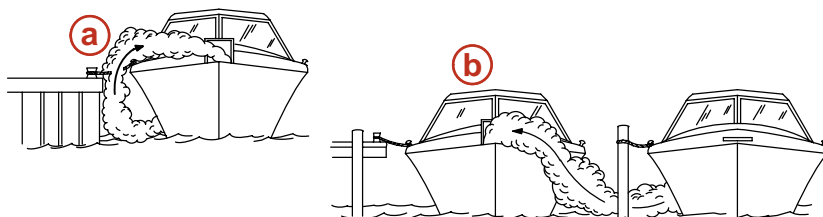

ob00317

- a- Running the engine when the boat is moored in a confined space.
- b- Mooring close to another boat that has its engine running.

## WHILE BOAT IS MOVING

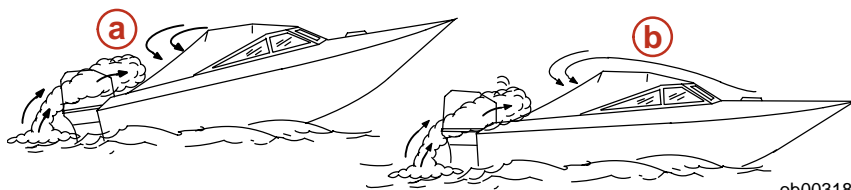

ob00318

- a- Running the boat with the trim angle of the bow too high.
- b- Running the boat with no forward hatches open.

## Selecting Accessories For Your Outboard

Genuine Mercury Precision or Quicksilver Accessories have been specifically designed and tested for your outboard. These accessories are available from Mercury Marine dealers.

### **WARNING**

Check with your dealer before installation of accessories. The misuse of acceptable accessories or the use of unacceptable accessories can result in serious injury, death, or product failure.

# GENERAL INFORMATION

Some accessories not manufactured or sold by Mercury Marine are not designed to be safely used with your outboard or outboard operating system. Acquire and read the installation, operation, and maintenance manuals for all your selected accessories.

## Safe Boating Suggestions

In order to safely enjoy the waterways, familiarize yourself with local and other governmental boating regulations and restrictions, and consider the following suggestions.

**Use flotation devices.** Have an approved personal flotation device of suitable size for each person aboard (it is the law) and have it readily accessible.

**Do not overload your boat.** Most boats are rated and certified for maximum load (weight) capacities (refer to your boat capacity plate). If in doubt, contact your dealer or the boats manufacturer.

**Perform safety checks and required maintenance.** Follow a regular schedule and ensure that all repairs are properly made.

**Know and obey all nautical rules and laws of the waterways.** Boat operators should complete a boating safety course. Courses are offered in the U.S.A. by 1) The U.S. Coast Guard Auxiliary, 2) The Power Squadron, 3) The Red Cross and 4) your state boating law enforcement agency. Inquiries may be made to the Boating Hotline, 1-800-368-5647 or the Boat U.S. Foundation information number 1-800-336-BOAT.

**Make sure everyone in the boat is properly seated.** Do not allow anyone to sit or ride on any part of the boat that was not intended for such use. This includes the back of seats, gunwales, transom, bow, decks, raised fishing seats, any rotating fishing seat; or anywhere that an unexpected acceleration, sudden stopping, unexpected loss of boat control, or sudden boat movement could cause a person to be thrown overboard or into the boat.

**Never be under the influence of alcohol or drugs while boating (it is the law).** Alcohol or drug use impairs your judgment and greatly reduces your ability to react quickly.

**Prepare other boat operators.** Instruct at least one other person on board in the basics of starting and operating the outboard, and boat handling, in case the driver becomes disabled or falls overboard.

**Passenger boarding.** Stop the engine whenever passengers are boarding, unloading, or are near the back (stern) of the boat. Just shifting the outboard into neutral is not sufficient.

**Be alert.** The operator of the boat is responsible by law to maintain a proper lookout by sight and hearing. The operator must have an unobstructed view particularly to the front. No passengers, load, or fishing seats should block the operators view when operating the boat above idle speed.

**Never drive your boat directly behind a water skier in case the skier falls.** As an example, your boat traveling at 40 km/h (25 MPH) will overtake a fallen skier 61 m (200 ft.) in front of you in 5 seconds.

**Watch fallen skiers.** When using your boat for water skiing or similar activities, always keep a fallen or down skier on the operator's side of the boat while returning to assist the skier. The operator should always have the down skier in sight and never back up to the skier or anyone in the water.

**Report accidents.** Boat operators are required by law to file a Boating Accident Report with their state boating law enforcement agency when their boat is involved in certain boating accidents. A boating accident must be reported if 1) there is loss of life or probable loss of life, 2) there is personal injury requiring medical treatment beyond first aid, 3) there is damage to boats or other property where the damage value exceeds \$500.00 or 4) there is complete loss of the boat. Seek further assistance from local law enforcement.

## Recording Serial Number

It is important to record this number for future reference. The serial number is located on the outboard as shown.

# GENERAL INFORMATION

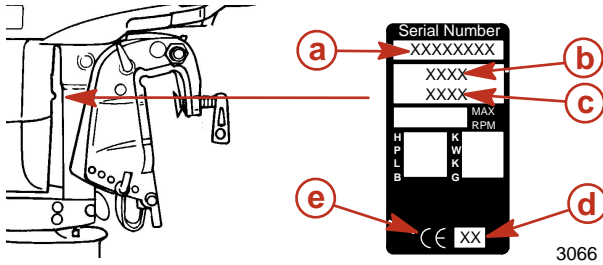

- a- Serial number
- b- Model year
- c- Model designation
- d- Year manufactured
- e- Certified Europe Insignia (as applicable)

## 40 Sea Pro/Marathon - 30/40 HP Specifications

Models	30	40
Horsepower	30	40
Kilowatts	22.4	29.8
Full Throttle RPM Range - Pleasure Models	4500-5500 RPM	5000-5500 RPM
Full Throttle RPM Range (Sea Pro/Marathon Models)	4500-5500 RPM	
Idle Speed in Forward Gear	700-750 RPM	
Number of Cylinders	2	
Piston Displacement	644 cc (39.3 cu. in.)	
Cylinder Bore	76 mm (2.993 in.)	
Piston Stroke	71 mm (2.796 in.)	
Recommended Spark Plug	NGK BPZ8H-N-10	
Spark Plug Gap	1.0 mm (0.040 in.)	
Gear Ratio	2.0:1	
Recommended Gasoline	Refer to <b>Fuel &amp; Oil</b>	
Recommended Oil	Refer to <b>Fuel &amp; Oil</b>	
Gearcase Lubricant Capacity	440 ml (14.9 fl. oz.)	
Battery Rating	465 Marine Cranking AMPS (MCA) or 350 Cold Cranking AMPS (CCA)	
Ampere Hours (Ah)	70-100	

# GENERAL INFORMATION

## Component Identification

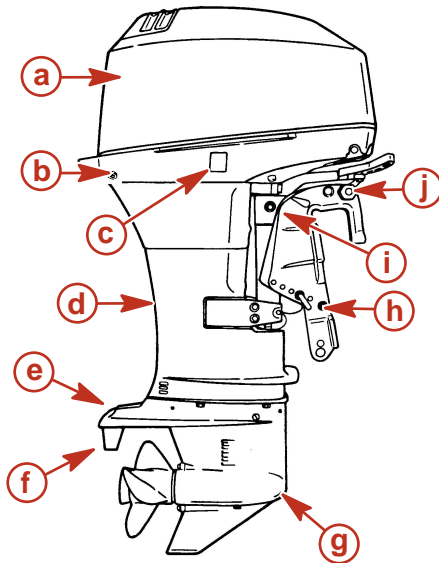

- a-** Top cowl
- b-** Water pump indicator hole
- c-** Auxiliary tilt switch
- d-** Driveshaft housing
- e-** Anti-ventilation plate
- f-** Trim tab
- g-** Gearcase
- h-** Transom brackets
- i-** Steering friction adjustment (non-tiller handle models)
- j-** Tilt lock lever

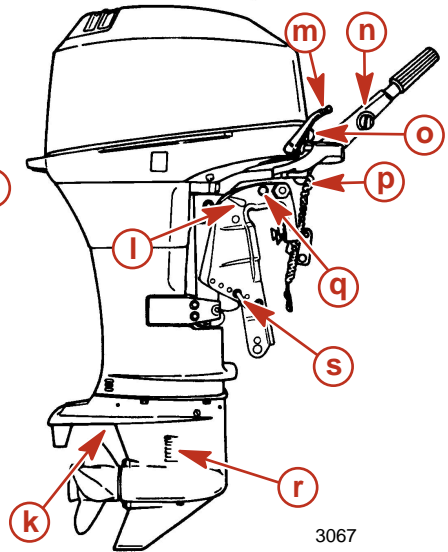

- k-** Secondary cooling water intake
- l-** Shallow water drive lever (non-power trim)
- m-** Shift handle
- n-** Throttle friction adjustment knob
- o-** Lanyard stop switch
- p-** Steering friction adjustment lever (tiller handle models)
- q-** Tilt support pin
- r-** Primary cooling water intake
- s-** Tilt pin

# GENERAL INFORMATION

## 40 SeaPro/Marathon Component Identification

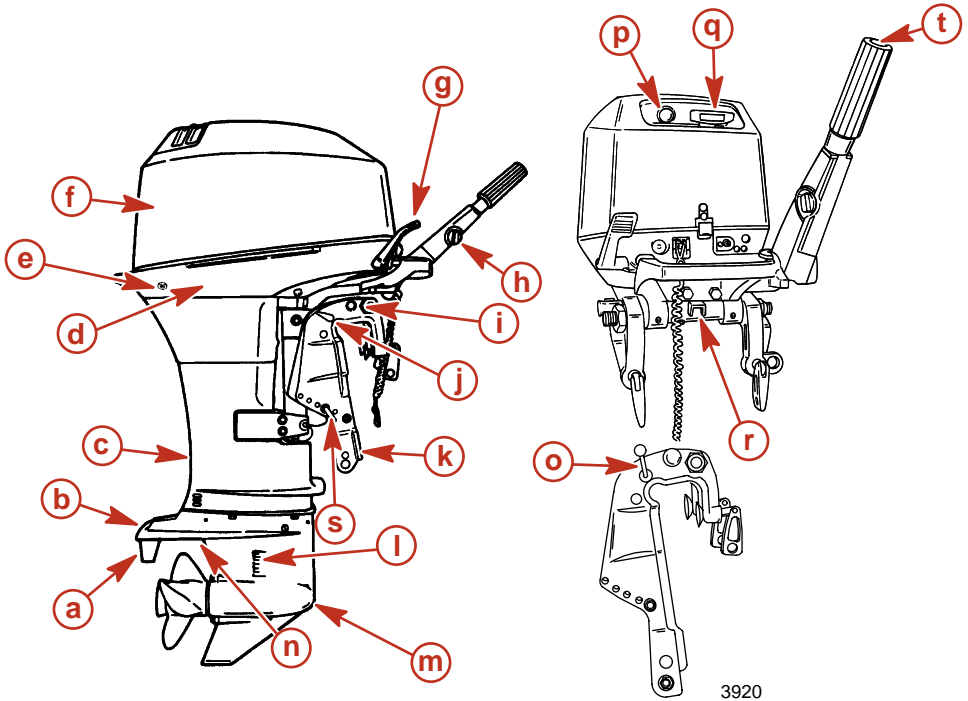

- |            |   |            |  |
|------------|---|------------|--|
| <b>a</b> - | Trim tab  | <b>k</b> - | Transom bracket                            |
| <b>b</b> - | Anti-ventilation plate                                  | <b>l</b> - | Primary cooling water intake               |
| <b>c</b> - | Driveshaft housing                                      | <b>m</b> - | Gearcase                                   |
| <b>d</b> - | Bottom cowl   | <b>n</b> - | Secondary cooling water intake             |
| <b>e</b> - | Water pump indicator hole                               | <b>o</b> - | Tilt lever - gas assisted type tilt system |
| <b>f</b> - | Top cowl  | <b>p</b> - | Primer                                     |
| <b>g</b> - | Shift handle  | <b>q</b> - | Starter rope                               |
| <b>h</b> - | Throttle friction adjustment                            | <b>r</b> - | Steering friction adjustment               |
| <b>i</b> - | Tilt support pin  | <b>s</b> - | Tilt pin                                   |
| <b>j</b> - | Shallow water drive/trailing lever - manual tilt system | <b>t</b> - | Stop switch                                |



# INSTALLATION

## Installing Outboard

### WARNING

Before operation, the outboard must be correctly installed with the required mounting hardware as shown. Failure to correctly fasten outboard could result in outboard ejecting off boat transom causing serious injury, death, or property damage.

We strongly recommend that your dealer install your outboard and related accessories to ensure proper installation and good performance. If you install the outboard yourself, follow instructions in the outboard installation manual which is provided with the outboard.

### MODELS WITHOUT TRANSOM BRACKET CLAMP SCREWS

The outboard must be secured to the transom with the four 12.7 mm (1/2 in.) diameter mounting bolts and locknuts provided. Install two bolts through the upper set of holes and two bolts through the lower set of holes.

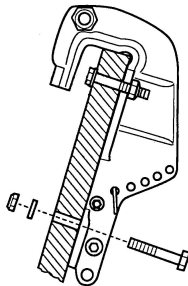

3068

### MODELS WITH TRANSOM BRACKET CLAMP SCREWS

The outboard must be secured to the transom one of two ways: either with clamp screws and the two mounting bolts, washers and locknuts provided, or with clamp screws and optional Quicksilver or Mercury Precision Parts Outboard Mounting Kit.

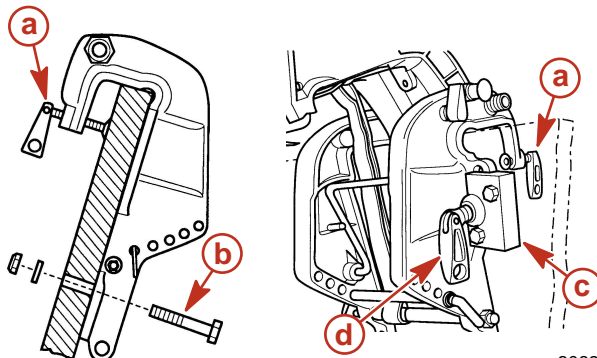

3069

- a-** Transom bracket clamp screws
- b-** Mounting bolts, washers and locknuts

- c-** Outboard mounting kit
- d-** Retainer screw

# INSTALLATION

## Propeller Selection

For best all around performance from your outboard/boat combination, select a propeller that allows the engine to operate in the upper half of the recommended full throttle RPM range with the boat normally loaded (refer to **General Information - Specifications**). This RPM range allows for better acceleration while maintaining maximum boat speed.

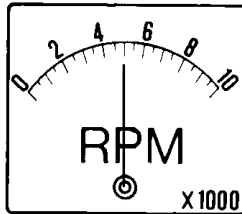

ob00323

If changing conditions cause the RPM to drop below the recommended range, such as warmer, more humid weather, operation at higher elevations, increased boat load, or a dirty boat bottom/gearcase, a propeller change or cleaning may be required to maintain performance and ensure the outboards durability.

Check full-throttle RPM, using an accurate tachometer, with the engine trimmed out to a balanced-steering condition (steering effort equal in both directions) without causing the propeller to break loose.

# TRANSPORTING

## Trailing Boat/Outboard

Trailer your boat with the outboard tilted down in a vertical operating position.

If additional ground clearance is required, the outboard should be tilted up using an accessory outboard support device. Refer to your local dealer for recommendations. Additional clearance may be required for railroad crossings, driveways and trailer bouncing.

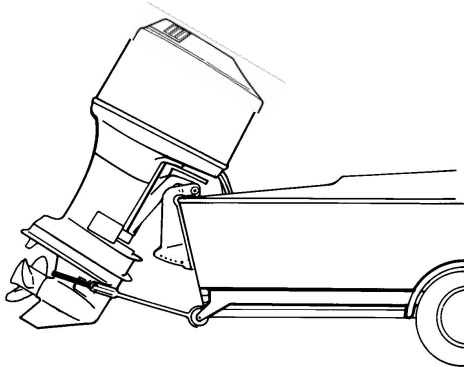

ob01074

**IMPORTANT:** Do not rely on the power trim/tilt system or tilt support lever to maintain proper ground clearance for trailering. The outboard tilt support lever is not intended to support the outboard for trailering.

Shift the outboard to forward gear. This prevents the propeller from spinning freely.

## Transporting Portable Fuel Tanks

### **WARNING**

Avoid serious injury or death from a gasoline fire or explosion. Follow portable fuel tank transporting instructions. Transport the fuel tank in a well ventilated area away from open flame or sparks.

### MANUAL VENTING TYPE FUEL TANK

1. Close fuel tank air vent when transporting tank. This will prevent escape of fuel or vapors from tank.

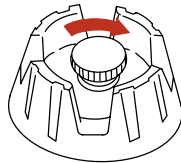

ob00325

### AUTO-VENTING TYPE FUEL TANK

1. Disconnect the remote fuel line from tank. This will close the air vent and prevent escape of fuel or vapors from tank.

# TRANSPORTING

2. Install tether cap over the fuel line connector stem. This will protect the connector stem from being accidentally pushed-in, thus, allowing fuel or vapor to escape.

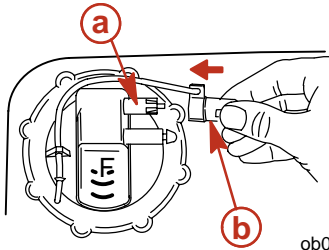

ob00326

**a -** Connector stem

**b -** Tether cap

# FUEL & OIL

## Gasoline Recommendations

### UNITED STATES AND CANADA

Use a major brand of automotive unleaded gasoline with a minimum posted octane rating of 87. Mid-grade automotive gasolines that contain fuel injector cleaner are preferred for added internal engine cleanliness. Leaded gasoline is not recommended.

### INTERNATIONAL

Use a major brand of automotive unleaded gasoline with a minimum posted octane rating of 90RON. Automotive gasolines that contain fuel injector cleaner are preferred for added internal engine cleanliness. Leaded gasoline is acceptable in areas where unleaded gasoline is not available.

### USING REFORMULATED (OXYGENATED) FUELS - UNITED STATES ONLY

This type of fuel is required in certain areas of the United States. The two types of reformulated ingredients in these fuels are alcohol (Ethanol) or Ether (MTBE or ETBE). If Ethanol is the oxygenates that is used in the gasoline, refer to **Alcohol in Gasoline**.

These reformulated fuels are acceptable for use in the Mercury engine.

### ALCOHOL IN GASOLINE

We do not recommend the use of gasoline which contains alcohol because of the possible adverse effect the alcohol may have on the fuel system. In general, if only gasoline containing alcohol is available, it must not contain more than 10% ethanol or 5% methanol, and the addition of a water separating fuel filter is recommended.

If gasoline containing alcohol is used or if you suspect the presence of alcohol in your gasoline, increase your inspection of the fuel system, visually checking for fuel leaks or abnormalities.

Gasoline containing alcohol may cause the following problems to your outboard and fuel system:

- Corrosion of metal parts
- Deterioration of elastomers and plastic parts
- Wear and damage of internal engine parts
- Starting and operating difficulties
- Vapor lock or fuel starvation

Some of these adverse effects are due to the tendency of gasoline containing alcohol to absorb moisture from the air, resulting in a phase of water and alcohol which separates from the gasoline in the fuel tank.

The adverse effects of alcohol are more severe with methanol and are worse with increasing content of alcohol.

## Oil Recommendation

Recommended Oil	Mercury or Quicksilver Premium 2-Cycle TC-W3 Outboard Oil
-----------------	---

**IMPORTANT:** Oil must be NMMA certified TC-W3 2-Cycle oil.

Mercury or Quicksilver Premium TC-W3 2-Cycle oil is recommended for this engine. For added protection and lubrication, Mercury or Quicksilver Premium Plus TC-W3 2-Cycle oil is recommended. If Mercury or Quicksilver outboard oil is not available, substitute another brand of 2-cycle outboard oil that is NMMA Certified TC-W3. Severe engine damage may result from use of an inferior oil.

## Fuel and Oil Ratio

### MODELS WITH OIL INJECTION

Use a 50:1 (2%) gasoline/oil mixture in the first tank of fuel. Follow the table below for mixing ratios. Use of this fuel mixture combined with oil from the oil injection system will supply adequate lubrication during engine break-in.

After the break-in fuel mixture is used up, it is no longer necessary to add oil with the gasoline.

**NOTE:** At the end of the break-in period, visually check to see if the oil level in the oil injection system has dropped. Oil usage indicates the oil injection system is functioning correctly.

# FUEL & OIL

GASOLINE/OIL MIXING RATIO CHART			
Gas/Oil Ratio	3.8 liters (1 gal.) gas	11.5 liters (3 gal.) gas	23 liters (6 gal.) gas
50:1 (2%)	89 ml (3 fl. oz.) oil	237 ml (8 fl. oz.) oil	473 ml (16 fl. oz.) oil

## MODELS WITHOUT OIL INJECTION

Use a 25:1 (4%) gasoline/oil mixture in the first tank of fuel.

After the break-in fuel mixture is used up, use a 50:1 (2%) gasoline/oil mixture. Follow the table for mixing ratios.

GASOLINE/OIL MIXING RATIO CHART			
Gas/Oil Ratio	3.8 liters (1 gal.) gas	11.5 liters (3 gal.) gas	23 liters (6 gal.) gas
25:1 (4%)	148 ml (5 fl. oz.) oil	473 ml (16 fl. oz.) oil	946 ml (32 fl. oz.) oil
50:1 (2%)	89 ml (3 fl. oz.) oil	237 ml (8 fl. oz.) oil	473 ml (16 fl. oz.) oil

## Mixing Fuel and Oil

**Portable Tank** - Pour 4 liters (1 gallon) of gasoline into tank. Add the correct amount of oil and mix thoroughly. Add the remainder of gasoline.

**Built-in Tank** - Using a funnel, pour the correct amount of oil slowly with the gasoline as tank is filled.

## Filling Oil Injection System

- Place outboard in a vertical operating position. Check oil level using the sight gauge in front of the outboard.

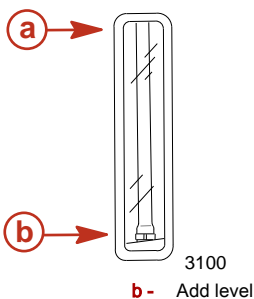

- Remove the fill cap and fill tank with oil.

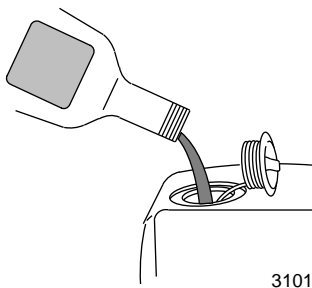

# FUEL & OIL

	Capacity	Fluid Type
Oil tank	1.5 liters (50.5 fl. oz.)	Mercury or Quicksilver Premium TC-W3 2-cycle oil

## Filling Fuel Tank

### **WARNING**

**Avoid serious injury or death from a gasoline fire or explosion. Always stop the engine and do not smoke or allow open flames or sparks in the area while filling fuel tanks.**

Fill fuel tanks outdoors away from heat, sparks, and open flames.

Remove portable fuel tanks from boat to refill them.

Always stop engine before refilling tanks.

Do not completely fill the fuel tanks. Leave approximately 10% of the tank volume unfilled. Fuel will expand in volume as its temperature rises and can leak under pressure if the tank is completely filled.

### **PORTABLE FUEL TANK PLACEMENT IN THE BOAT**

Place the fuel tank in the boat so the vent is higher than the fuel level under normal boat operating conditions.

# FEATURES & CONTROLS

## Remote Control Features

Your boat may be equipped with one of the Mercury Precision or Quicksilver remote controls shown. If not, consult your dealer for a description of the functions and operations of the remote control.

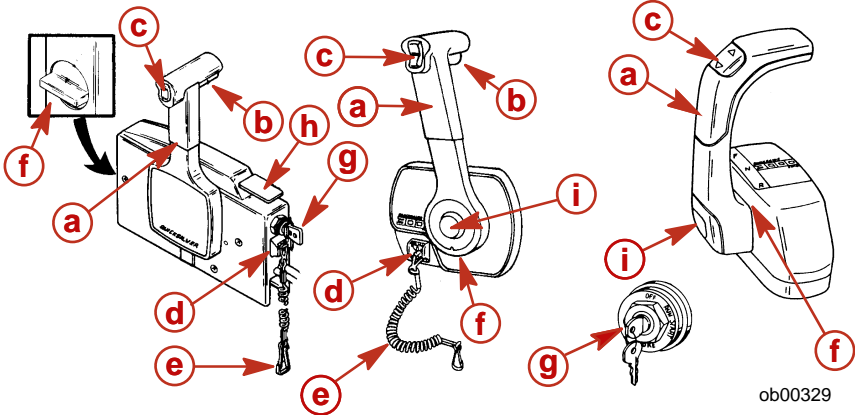

ob00329

- a - Control handle - forward, neutral, reverse.
- b - Neutral release lever
- c - Trim/tilt switch (if equipped). - Refer to **Features & Controls - Power Trim and Tilt**.
- d - Lanyard stop switch - Refer to **General Information - Lanyard Stop Switch**.
- e - Lanyard - Refer to **General Information - Lanyard Stop Switch**.
- f - Throttle friction adjustment - Console controls require cover removal for adjustment.
- g - Ignition key switch - off, on, start.
- h - Fast idle lever - Refer to **Operation - Starting the Engine**.
- i - Throttle only button - Refer to **Operation - Starting the Engine**.

## Warning System - Electric Start Models

### WARNING SYSTEM

The outboard warning system incorporates a warning horn inside the boat. Remote control models will have the warning horn located inside the remote control or connected to the ignition key switch. Tiller handle models will have the warning horn located in the ignition key panel.

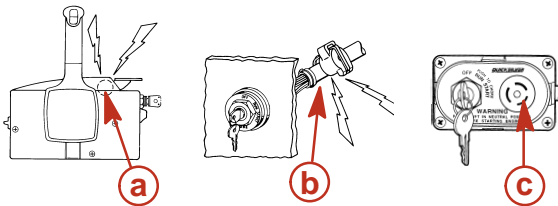

ob00332

- a - Horn inside remote control
- b - Horn connected to ignition key switch
- c - Horn in ignition key panel



# FEATURES & CONTROLS

## WARNING SYSTEM OPERATION

The warning horn will emit a continuous beep. This will alert the operator and help identify the following listed situations.

Warning System		
Function	Sound	Description
Engine Over Temperature	Continuous	Engine Over Heat
Low Oil Level	Continuous	Low Oil Level

## ENGINE OVERHEAT

If the engine overheats, immediately reduce throttle speed to idle. Shift outboard into neutral and check for a steady stream of water coming out of the water pump indicator hole.

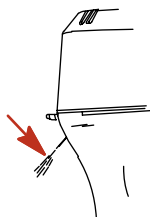

ob00331

If no water is coming out of the water pump indicator hole or flow is intermittent, stop engine and check the cooling water intake holes for obstruction. If no obstruction is found, there may be a blockage in the cooling system or a water pump problem. Have the outboard checked by your dealer. Operating the engine while overheated will cause engine damage.

**NOTE:** Should overheating occur and you are stranded, stop the engine and allow it to cool down. This will usually allow some additional low speed (idle) running time before the engine starts to overheat again. Operating an overheated engine will cause engine damage.

If a steady flow of water is coming out of the water pump indicator hole and the engine continues to overheat, consult your dealer. Operating an overheated engine will cause engine damage.

## LOW OIL LEVEL

The warning system will be activated if the oil level drops below the sight gauge in the cowl when the outboard is in a vertical position. There is still oil reserve remaining for 30 minutes of full speed operation. Refer to **Fuel & Oil - Filling Oil Injection System**.

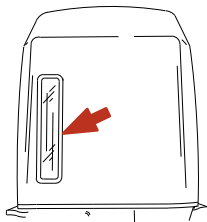

3103

## Warning Horn System - Manual Start Models

The outboard warning system incorporates a warning horn beneath the bottom cowl. The warning horn will sound if the engine overheats.

# FEATURES & CONTROLS

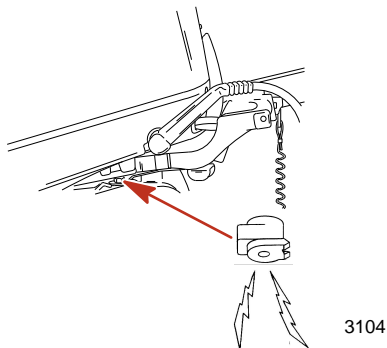

## ENGINE OVERHEAT

If the engine overheats, the warning horn will sound and the warning system will automatically limit the engine speed to 2500 RPM. Immediately reduce throttle speed to idle. Shift outboard into neutral and check for a steady stream of water coming out of the water pump indicator hole.

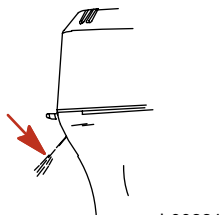

If no water is coming out of the water pump indicator hole or flow is intermittent, stop engine and check the cooling water intake holes for obstruction. If no obstruction is found, there may be a blockage in the cooling system or a water pump problem. Have the outboard checked by your dealer. Operating the engine while overheated will cause engine damage.

**NOTE:** *Should overheating occur and you are stranded, stop the engine and allow it to cool down. This will usually allow some additional low speed (idle) running time before the engine starts to overheat again. Operating an overheated engine will cause engine damage.*

If a steady flow of water is coming out of the water pump indicator hole and the engine continues to overheat, consult your dealer. Operating an overheated engine will cause engine damage.

## Engine Over-Speed Limiter

The outboard is equipped with an engine over-speed limiter which limits the engine maximum RPM. This will protect the engine from mechanical damage.

Some causes of engine over-speed are as follows:

- Propeller ventilation.
- A propeller which has an incorrect pitch or diameter.
- Propeller hub slippage.
- Outboard mounted too high on the transom.
- Tilting the outboard out beyond a vertical position.
- Cavitation of the propeller due to rough water or obstruction in the boat hull.

When the engine over-speed limiter is activated, the engine timing will be momentarily retarded to decrease the engine speed. Excessive over-speed (above 6000 RPM) will result in cutout of the cylinders to prevent operation above this limit.

# FEATURES & CONTROLS

## Manual Tilt System

### TILT LOCK LEVER

The tilt lock lever is used to engage the reverse lock mechanism, and prevent the outboard from lifting out of the water when operating in reverse gear due to reverse propeller thrust. The tilt lock lever can be placed in two positions as follows.

Release Position - Placing the tilt lock lever up in the release position will allow you to tilt up the outboard.

Lock Position - Place the tilt lock lever down in the lock position whenever operating the outboard.

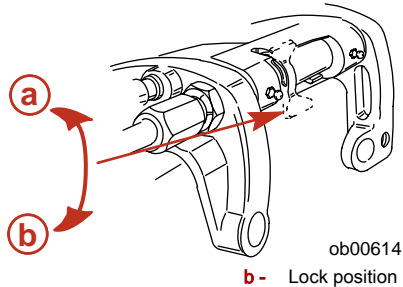

**a -** Release position

**b -** Lock position

**NOTE:** With the tilt lock lever in the lock position, the outboard will still kick up if an underwater obstruction is hit.

### TILTING OPERATION

#### Tilting To Full Up Position

1. Stop the engine.
2. Push the tilt lock lever up to the release position.
3. Take hold of the top cowl grip and raise outboard to the full up position.
4. Push in the tilt support pin. Lower the outboard to rest on the tilt support pin.

# FEATURES & CONTROLS

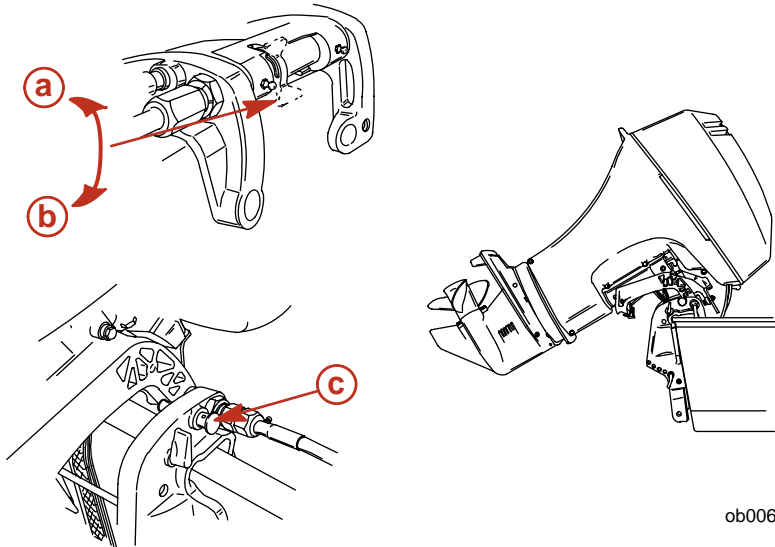

ob00615

- a-** Release position
- b-** Lock position
- c-** Tilt support pin

## Lowering To Run Position

1. Raise outboard slightly and pull out the tilt support pin. Lower the outboard.
2. Move the tilt lock lever down to the lock position.

## SHALLOW WATER OPERATION

The shallow water drive feature on the outboard allows you to position the outboard at a higher tilt angle to prevent hitting bottom.

**IMPORTANT:** While in shallow water, operate the outboard at slow speed and keep the cooling water intake submerged.

### Engaging Shallow Water Drive

1. Reduce engine speed to idle.
2. Push the tilt lock lever up to the release position.
3. Rotate knob to engage the shallow water drive bracket.

# FEATURES & CONTROLS

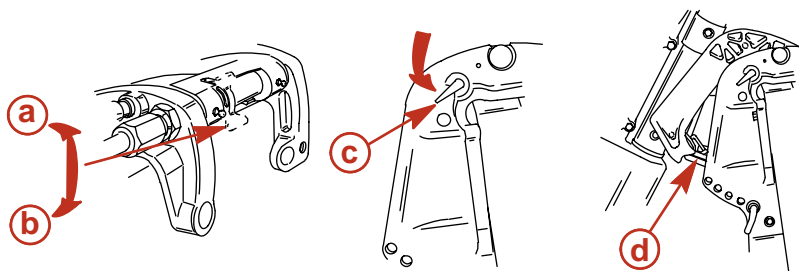

**a-** Release position

**b-** Lock position

**c-** Knob

**d-** Shallow water drive bracket

ob00616

4. Take hold of the top cowl grip and raise outboard to enable the shallow water drive bracket to swing down.
5. Lower the outboard to rest on the shallow water drive bracket.
6. Move the tilt lock lever down to the lock position.

## Releasing Outboard From Shallow Water Drive Position

1. Push the tilt lock lever up to the release position.
2. Raise outboard slightly and rotate knob to disengage the shallow water drive bracket. Lower the outboard down.
3. Move the tilt lock lever down to the lock position.

## SETTING THE OPERATING ANGLE OF THE OUTBOARD

The vertical operating angle of your outboard is adjusted by changing the position of the tilt pin in the five adjustment holes provided. The outboard should be locked against this tilt pin by setting the tilt lock lever to the lock/run position. Proper adjustment allows the boat to achieve optimum performance, stability, and minimize steering effort.

**NOTE:** Refer to the following lists when adjusting the operating angle of your outboard.

The tilt pin should be adjusted so the outboard is positioned to run perpendicular to the water when the boat is running at full speed. This allows the boat to be driven parallel to the water.

Arrange passengers and load in the boat so the weight is distributed evenly.

# FEATURES & CONTROLS

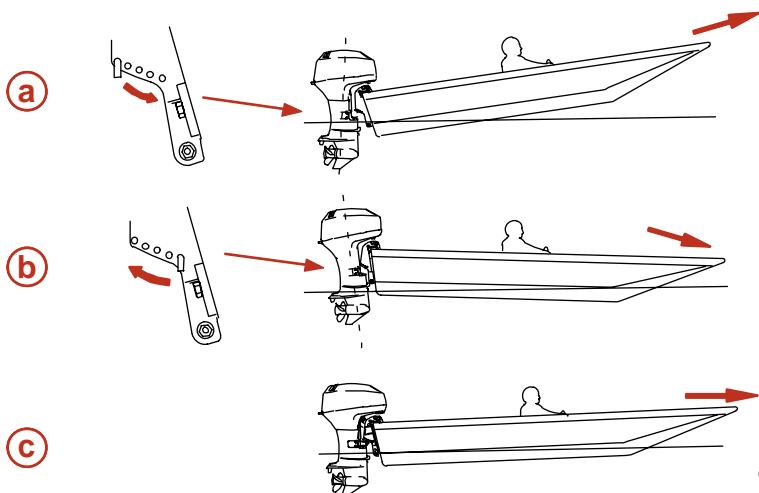

ob00613

- a-** Too much angle (stern down - bow up)
- b-** Not enough angle (stern up - bow down)
- c-** Angle adjusted properly (bow slightly up)

Consider the following lists carefully when adjusting the operating angle of your outboard.

Adjusting the outboard close to the boat transom can:

- Lower the bow.
- Result in quicker planing off, especially with a heavy load or a stern heavy boat.
- Generally improve the ride in choppy water.
- Increase steering torque or pull to the right (with the normal right hand rotation propeller).
- In excess can lower the bow of some boats to a point where they begin to plow with their bow in the water while on plane. This can result in an unexpected turn in either direction (called bow steering or over-steering) if any turn is attempted or if a significant wave is encountered.

Adjusting the outboard away from the boat transom can:

- Lift the bow out of the water.
- Generally increase top speed.
- Increase clearance over submerged objects or a shallow bottom.
- Increase steering torque or pull to the left at a normal installation height (with the normal right hand rotation propeller).
- In excess can cause boat porpoising (bouncing) or propeller ventilation.

## MANUAL GAS ASSISTED TILT SYSTEM - TILLER HANDLE MODELS

Models equipped with a gas assisted tilt system allows the operator to easily tilt and lock the outboard at any tilt position from full down to full up.

This tilt system is designed to be adjusted when the outboard is idling in neutral or with the engine turned off.

Before operating, the outboard must be locked in its tilt position by moving the tilt lock lever to the lock/run position.

# FEATURES & CONTROLS

## ⚠ WARNING

Before operating, the outboard must be locked in its lock/run position. Failure to lock the outboard in its lock/run position could result in the outboard tilting up out of the water during deceleration or while operating in reverse, resulting in possible loss of boat control. Loss of boat control can result in serious injury, death, or boat damage.

### Basic Tilting Operation

Move tilt lock lever to the tilt position. Tilt outboard to desired position and lock in place by moving the tilt lock lever back to the lock/run position.

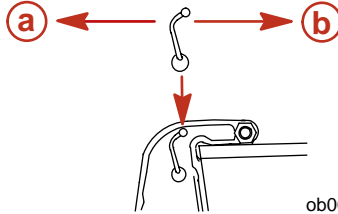

**a-** Tilt position

**b-** Lock/run position

### Shallow Water Operation

When operating your boat in shallow water, the outboard can be adjusted and locked at a higher tilt angle. Operate your outboard at slow speed while tilted up for shallow water operation. Keep the cooling water intake holes submerged in the water and continue to check for water discharge from the water pump indicator hole.

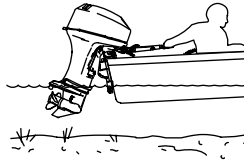

ob00609

### Tilting Outboard To Full Up Position

1. Stop the engine. Move the tilt lock lever to the tilt position. Take hold of the top cowl grip and raise outboard to full tilt up position. Lock the outboard in place by moving the tilt lock lever to the lock/run position.



ob00610

2. Push in the tilt support pin.
3. Lower outboard to rest on the tilt support pin.

### Lowering Outboard to run position

1. Raise the outboard off the support pin to disengage tilt support. Pull out the support pin and lower the outboard.
2. Move tilt lock lever to lock/run position.

# FEATURES & CONTROLS

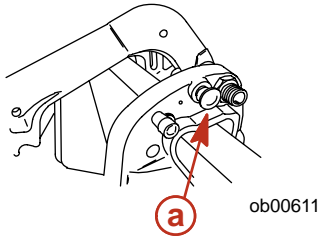

- a -** Tilt support pin

## Operating Angle Adjustment

The transom brackets have five holes for adjusting the operating angle (forward stop movement) of the outboard. Tilt stops are installed for adjustment in the first hole. Use tilt pin provided for adjustments in the remaining four holes. Remove tilt pin when using the tilt stops.

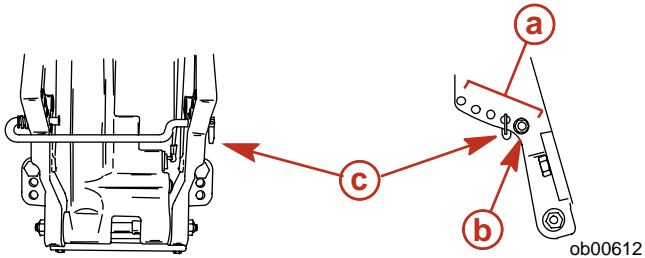

- a -** Transom bracket holes
- b -** Tilt stops
- c -** Tilt pin

Adjust the operating angle of the outboard so that the outboard runs perpendicular to the water when the boat is at full speed.

Arrange passengers and load in the boat so the weight is distributed evenly.



# FEATURES & CONTROLS

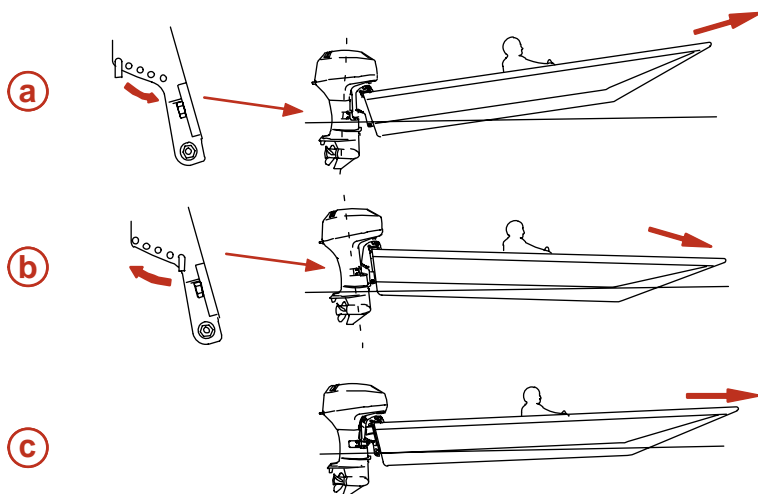

**a-** Too much angle (bow up) - adjust in.

**c-** Angle adjusted properly (bow slightly up).

**b-** Not enough angle (bow down) - adjust out.

**NOTE:** The outboard should be locked against the tilt stops or tilt pin during operation by setting the tilt lock lever to the lock/run position.

Consider the following lists carefully when adjusting the operating angle of your outboard.

Adjusting the outboard close to the boat transom can:

- Lower the bow.
- Result in quicker planing off, especially with a heavy load or a stern heavy boat.
- Generally improve the ride in choppy water.
- Increase steering torque or pull to the right (with the normal right hand rotation propeller).
- In excess can lower the bow of some boats to a point where they begin to plow with their bow in the water while on plane. This can result in an unexpected turn in either direction (called bow steering or over-steering) if any turn is attempted or if a significant wave is encountered.

Adjusting the outboard away from the boat transom can:

- Lift the bow out of the water.
- Generally increase top speed.
- Increase clearance over submerged objects or a shallow bottom.
- Increase steering torque or pull to the left at a normal installation height (with the normal right hand rotation propeller).
- In excess can cause boat porpoising (bouncing) or propeller ventilation.

## Power Trim And Tilt (if equipped)

### POWER TRIM AND TILT

Your outboard has a trim/tilt control called power trim. This enables the operator to easily adjust the position of the outboard by pressing the trim switch. Moving the outboard in closer to the boat transom is called trimming in or down. Moving the outboard further away from the boat transom is called trimming out or up. The term trim generally refers to the adjustment of the outboard within the first 20° range of travel. This is the range used while operating your boat on plane. The term tilt is generally used when referring to adjusting the outboard further up out of the water. With the engine turned off, the outboard can be tilted out of the water. At low idle speed, the outboard can also be tilted up past the trim range to permit, for example, shallow water operation.

# FEATURES & CONTROLS

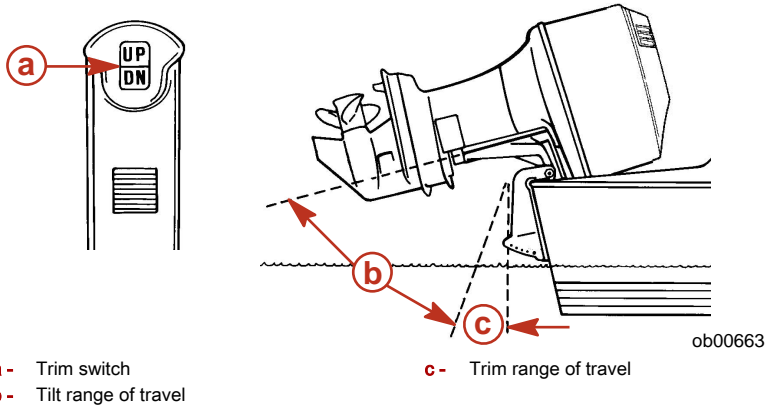

## POWER TRIM OPERATION

With most boats, operating around the middle of the trim range will give satisfactory results. However, to take full advantage of the trimming capability there may be times when you choose to trim your outboard all the way in or out. Along with an improvement in some performance aspects comes a greater responsibility for the operator, and this is being aware of some potential control hazards.

The most significant control hazard is a pull or torque that can be felt on the steering wheel or tiller handle. This steering torque results from the outboard being trimmed so that the propeller shaft is not parallel to the water surface.

### **WARNING**

**Avoid possible serious injury or death. When the outboard is trimmed in or out beyond a neutral steering condition, a pull on the steering wheel or tiller handle in either direction may result. Failure to keep a continuous firm grip on the steering wheel or tiller handle when this condition exists can result in loss of boat control as the outboard can turn freely. The boat can now spin out or go into a very tight maximum turn which, if unexpected, can result in occupants being thrown within the boat or out of the boat.**

Consider the following lists carefully.

1. Trimming In or Down Can:
  - Lower the bow.
  - Result in quicker planing off, especially with a heavy load or a stern heavy boat.
  - Generally improve the ride in choppy water.
  - Increase steering torque or pull to the right (with the normal right hand rotation propeller).
  - In excess can lower the bow of some boats to a point where they begin to plow with their bow in the water while on plane. This can result in an unexpected turn in either direction (called bow steering or over-steering) if any turn is attempted, or if a significant wave is encountered.

# FEATURES & CONTROLS

## WARNING

**Avoid possible serious injury or death. Adjust outboard to an intermediate trim position as soon as boat is on plane to avoid possible ejection due to boat spin out. Do not attempt to turn boat when on plane if outboard is trimmed extremely in or down and there is a pull on the steering wheel or tiller handle.**

- In rare circumstances, the owner may decide to limit the trim in. This can be accomplished by repositioning the tilt stop pin into whatever adjustment hole in the transom bracket is desired.
2. Trimming Out or Up can:
    - Lift the bow higher out of the water.
    - Generally increase top speed.
    - Increase clearance over submerged objects or a shallow bottom.
    - Increase steering torque or pull to the left at a normal installation height (with the normal right hand rotation propeller).
    - In excess can cause boat porpoising (bouncing) or propeller ventilation.
    - Cause engine overheating if any cooling water intake holes are above the water line.

## TILTING OPERATION

To tilt outboard, shut off the engine and press the trim/tilt switch or auxiliary tilt switch to the up position. The outboard will tilt up until the switch is released or it reaches its maximum tilt position.

1. Push in the tilt support pin.

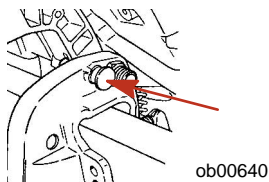

2. Lower outboard to rest on the tilt support pin.
3. Disengage the tilt support pin, by raising the outboard off the support pin and pulling out the support pin. Lower the outboard.

## MANUAL TILTING

If the outboard cannot be tilted using the power trim/tilt switch, the outboard can be manually tilted.

**NOTE:** The manual tilt release valve must be tightened before operating the outboard to prevent the outboard from tilting up during reverse operation.

1. Turn out the manual tilt release valve 3 turns counterclockwise. This allows manual tilting of the outboard. Tilt the outboard to the desired position and tighten the manual tilt release valve.

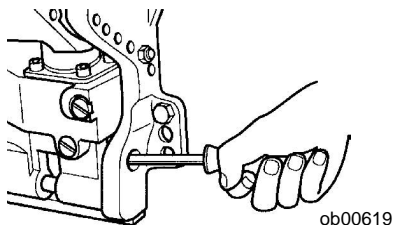

## AUXILIARY TILT SWITCH

The auxiliary tilt switch can be used to tilt the outboard up or down using the power trim system.

# FEATURES & CONTROLS

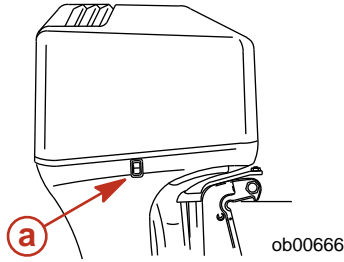

**a** - Auxiliary tilt switch

## SHALLOW WATER OPERATION

When operating your boat in shallow water, you can tilt the outboard beyond the maximum trim range to prevent hitting bottom.

1. Reduce engine speed below 2000 RPM.
2. Tilt outboard up. Make sure all the water intake holes stay submerged at all times.
3. Operate the engine at slow speed only. If engine speed exceeds 2000 RPM, the outboard will automatically return down to the maximum trim range.

## Throttle Grip Friction Adjustment - Tiller Handle Models

Throttle Grip Friction Knob - Turn friction knob to set and maintain the throttle at desired speed. Turn knob clockwise to tighten friction and turn knob counterclockwise to loosen friction.

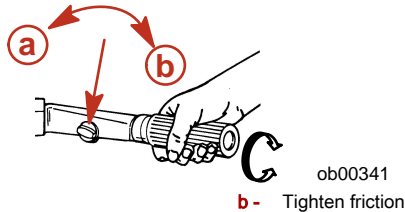

**a** - Loosen friction

**b** - Tighten friction

## Steering Friction Adjustment

### TILLER HANDLE MODELS

#### **WARNING**

**Avoid possible serious injury or death from loss of boat control. Maintain sufficient steering friction to prevent the outboard from steering into a full turn if the tiller handle or steering wheel is released.**

Steering Friction Adjustment - Adjust this lever to achieve the desired steering friction (drag) on the tiller handle. Move lever to the left to tighten friction or move to the right to loosen friction.

# FEATURES & CONTROLS

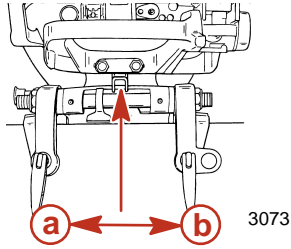

**a -** Tighten friction

**b -** Loosen friction

## REMOTE STEERING MODELS

Steering Friction Adjustment - Adjust this screw to achieve the desired steering friction (drag) on the steering wheel. Turn screw clockwise to tighten friction or turn counterclockwise to loosen friction.

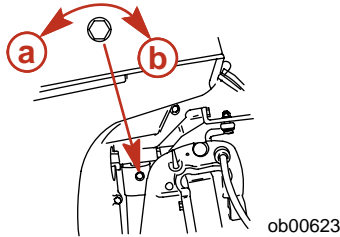

**a -** Loosen friction

**b -** Tighten friction

## Trim Tab Adjustment

Propeller steering torque will cause your boat to pull in one direction. This steering torque is a normal result from your outboard not trimmed with the propeller shaft parallel to the water surface. The trim tab can help to compensate for this steering torque in many cases and can be adjusted within limits to reduce any unequal steering effort.

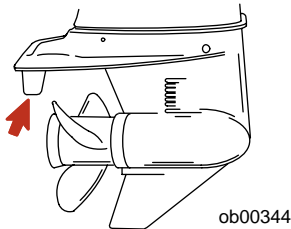

ob00344

**NOTE:** Trim tab adjustment will have little effect reducing steering torque if the outboard is installed with the anti-ventilation plate approximately 50 mm (2 in.) or more above the boat bottom.

## MODELS WITHOUT POWER TRIM

Operate your boat at normal cruising speed trimmed to desired position by installing the tilt pin in the desired tilt pin hole. Turn your boat left and right and note the direction the boat turns more easily.

If adjustment is necessary, loosen trim tab bolt and make small adjustments at a time. If the boat turns more easily to the left, move the trailing edge of trim tab to the left. If the boat turns more easily to the right move the trailing edge of trim tab to the right. Retighten bolt and retest.

# FEATURES & CONTROLS

## MODELS WITH POWER TRIM

Operate your boat at normal cruising speed, trimmed to desired position. Turn your boat left and right and note the direction the boat turns more easily.

If adjustment is necessary, loosen trim tab bolt and make small adjustments at a time. If the boat turns more easily to the left, move the trailing edge of trim tab to the left. If the boat turns more easily to the right move the trailing edge of trim tab to the right. Retighten bolt and retest.

# OPERATION

## Pre-Starting Check List

- Operator knows safe navigation, boating, and operating procedures.
- An approved personal flotation device of suitable size for each person aboard and readily accessible (it is the law).
- A ring type life buoy or buoyant cushion designed to be thrown to a person in the water.
- Know the boat's maximum load capacity. Look at the boat capacity plate.
- Fuel supply OK.
- Oil supply (oil injection) OK.
- Arrange passengers and load in the boat so the weight is distributed evenly and everyone is seated in a proper seat.
- Tell someone where you are going and when you expect to return.
- It is illegal to operate a boat while under the influence of alcohol or drugs.
- Know the waters and area you will be boating; tides, currents, sand bars, rocks, and other hazards.
- Make inspection checks listed in **Maintenance - Inspection and Maintenance Schedule**.

## Operating In Freezing Temperatures

When using your outboard or having your outboard moored in freezing or near freezing temperatures, keep the outboard tilted down at all times so the gearcase is submerged. This prevents trapped water in gearcase from freezing and causing possible damage to the water pump and other components.

If there is a chance of ice forming on the water, the outboard should be removed and drained completely of water. If ice should form at the water level inside the outboard driveshaft housing, it will block water flow to the engine causing possible damage.

## Operating In Salt Water Or Polluted Water

We recommend that you flush the internal water passages of your outboard with fresh water after each use in salt or polluted water. This will prevent a buildup of deposits from clogging the water passages. Refer to **Maintenance - Flushing The Cooling System**.

If you keep your boat moored in the water, always tilt the outboard so the gearcase is completely out of water (except in freezing temperatures) when not in use.

Wash the outboard exterior and flush out the exhaust outlet of the propeller and gearcase with fresh water after each use. Each month, spray Mercury Precision or Quicksilver Corrosion Guard on external metal surfaces. Do not spray on corrosion control anodes as this will reduce the effectiveness of the anodes.

## Operating at High Elevations

**IMPORTANT: To prevent serious damage to the engine caused by a lean fuel mixture, do not operate your outboard (if the jets were changed for high elevation) at a lower elevation unless the jets are changed again to correspond to the new elevation.**

Operating your outboard at an elevation higher than 750 m (2500 ft.) above sea level may require a carburetor jet change and/or different pitch propeller. Consult your dealer. This will reduce the normal performance loss experienced as a result of reduced oxygen in the air causing an overly rich fuel mixture.

## Engine Break-in Procedure

### CAUTION

Severe damage to the engine can result by not complying with the Engine Break-in Procedure.

## MODELS WITH OIL INJECTION

**Engine Break-in Fuel Mixture** - Use a 50:1 (2%) gasoline/oil mixture in the first tank of fuel. Use of this fuel mixture combined with oil from the oil injection system will supply adequate lubrication during engine break-in.

# OPERATION

**Engine Break-in Procedure** - Vary the throttle setting during the first hour of operation. During the first hour of operation, avoid remaining at constant speed for more than two minutes and avoid sustained wide open throttle.

## MODELS WITHOUT OIL INJECTION

**Engine Break-in Fuel Mixture** - Use a 25:1 (4%) gasoline/oil mixture in the first tank of fuel. After the break-in fuel mixture is used up, use a 50:1 (2%) gasoline/oil mixture.

**Engine Break-in Procedure** - Vary the throttle setting during the first hour of operation. During the first hour of operation, avoid remaining at constant speed for more than two minutes and avoid sustained wide open throttle.

## Starting The Engine - Electric Start Remote Control Models

Before starting, read the Pre-Starting Check List, Special Operating Instructions, and Engine Break-in Procedure in the Operation Section.

### CAUTION

Never start or operate your outboard (even momentarily) without water circulating through all the cooling water intake holes in the gearcase to prevent damage to the water pump (running dry) or overheating of the engine.

1. Make sure the cooling water intake is submerged.

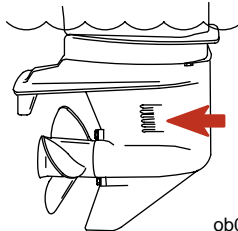

ob00347

2. Open fuel tank vent screw (in filler cap) on manual venting type fuel tanks.

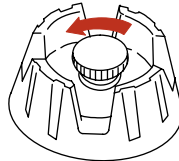

ob00348

3. Connect the fuel line to the outboard.

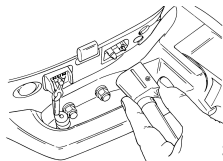

3074

4. Squeeze the fuel line primer bulb several times until it feels firm.

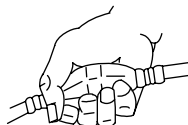

ob00349

5. Set the lanyard stop switch to "RUN" position. Refer to **General Information - Lanyard Stop Switch**.



# OPERATION



ob00350

- Shift outboard to neutral (N) position.

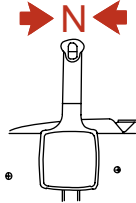

ob00351

- Models without power trim - Position the tilt lock lever down to the lock position.

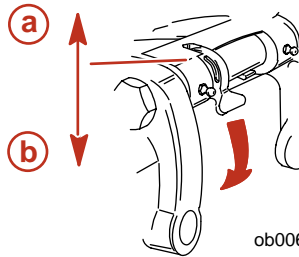

ob00625

## ⚠ WARNING

**Models without power trim - Before operating, the outboard must be locked in its tilt position. Failure to lock the outboard in its tilt position could result in the outboard lifting out of the water when operating in reverse, resulting in possible loss of boat control. Loss of boat control can result in serious injury, death, or boat damage.**

- Cold Engine - Advance the fast idle lever or throttle only feature to an approximate halfway (1/2) setting. After engine start up, immediately adjust neutral fast idle setting so engine speed drops below 2000 RPM. Return back to normal idle speed after engine is warmed up.

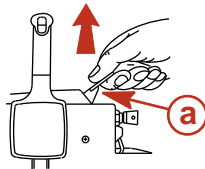

**a -** Fast idle speed lever

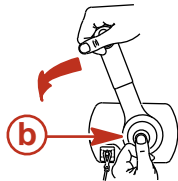

3030

**b -** Throttle only feature

- Turn ignition key to the "START" position and start the engine. If engine is cold, push in on key to choke engine. If engine fails to start in 10 seconds, wait 30 seconds and try again. If engine begins to stall, re-prime (push key in) until engine is running.

# OPERATION

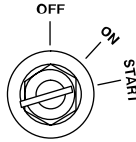

ob00354

10. Starting Flooded Engine - Advance the fast idle lever or throttle only feature to the maximum position. Without activating primer, crank engine for 10 seconds. Wait 30 seconds and repeat until engine starts. Immediately start to reduce engine speed after engine starts.
11. After engine starts, check for a steady stream of water flowing out of the water pump indicator hole.

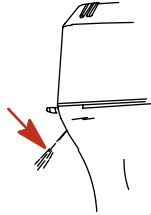

ob00331

**IMPORTANT:** If no water is coming out of the water pump indicator hole, stop engine and check cooling water intake for obstruction. No obstruction may indicate a water pump failure or blockage in the cooling system. These conditions will cause the engine to overheat. Have the outboard checked by your dealer. Operating the engine while overheated will cause engine damage.

## Starting The Engine - Tiller Handle Models And Manual Start Remote Control Models

Before starting, read the Pre-Starting Check List, Special Operating Instructions, and Engine Break-in Procedure in the Operation Section.

### CAUTION

Never start or operate your outboard (even momentarily) without water circulating through all the cooling water intake holes in the gearcase to prevent damage to the water pump (running dry) or overheating of the engine.

1. Make sure the cooling water intake is submerged.

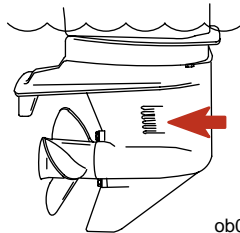

ob00347

2. Open fuel tank vent screw (in filler cap) on manual venting type fuel tanks.

# OPERATION

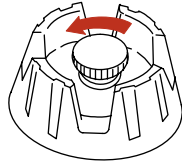

ob00348

3. Connect the fuel line to the outboard.

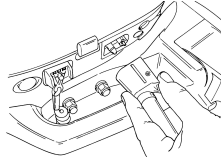

3074

4. Squeeze the fuel line primer bulb several times until it feels firm.

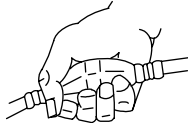

ob00349

5. Set the lanyard stop switch to "RUN" position. Refer to **General Information - Lanyard Stop Switch**.



ob00350

6. Shift outboard to neutral (N) position.

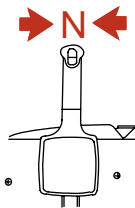

ob00351

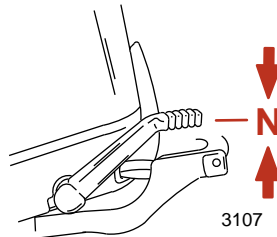

3107

7. Position the tilt lock lever to the lock position.

# OPERATION

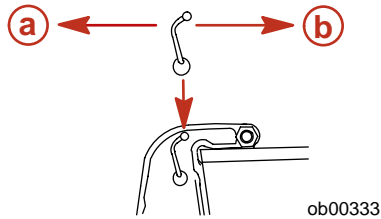
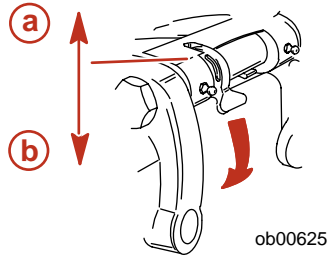

**a** - Reverse/tilt position

**b** - Lock/run position

8. Tiller handle models - Move throttle grip to "START" position.

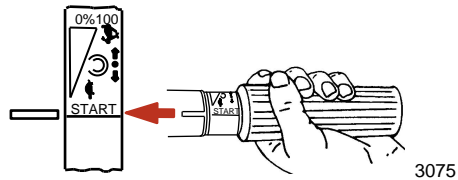

9. Remote control models - Move on/off switch to the on position.

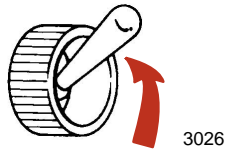

**NOTE:** Manual starting models - For initial start of a new engine or first start after a prolonged storage, primer lines may have air in them. In this case, push in the primer bulb several times until fluid can be felt and then the normal 4 to 6 rapid primes.

10. Manual starting models - If engine is cold, push in the primer bulb rapidly 4 to 6 times.

# OPERATION

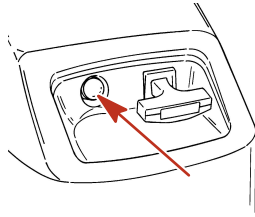

- a. Pull the starter rope slowly until starter engages, then pull rapidly to crank the engine.
- b. Allow rope to return slowly. Repeat until engine starts. If engine begins to stall, re-prime until engine is running.

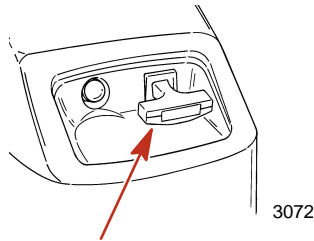

11. Electric starting models - Turn ignition key to the "START" position and start the engine. If engine is cold, push in on key to choke engine. If engine fails to start in 10 seconds, wait 30 seconds and try again. If engine begins to stall, re-prime (push key in) until engine is running.

## WARNING

**RAPID ACCELERATION HAZARD - Before shifting your outboard from neutral into gear, decrease engine speed to slow. This will prevent a rapid acceleration that can cause people in the boat to be thrown from their seats or out of the boat, causing injury or death.**

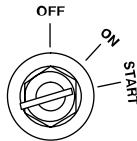

12. Check for a steady stream of water flowing out of the water pump indicator hole.

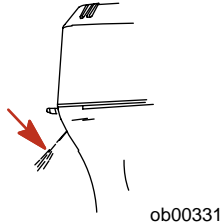

**IMPORTANT:** If no water is coming out of the water pump indicator hole, stop engine and check cooling water intake for obstruction. No obstruction may indicate a water pump failure or blockage in the cooling system. These conditions will cause the engine to overheat. Have the outboard checked by your dealer. Operating the engine while overheated will cause serious engine damage.

# OPERATION

## Gear Shifting

**IMPORTANT:** Never shift outboard into gear unless engine speed is at idle. Do not shift outboard into reverse when the engine is not running.

- The outboard has three gear shift positions to provide operation: Forward (F), Neutral (N), and Reverse (R).

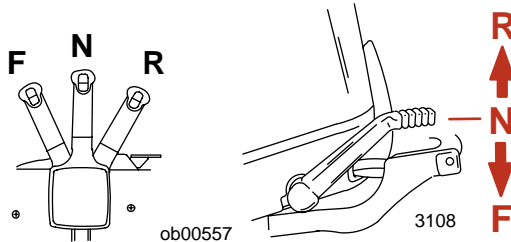

- Remote Control Models** - When shifting, always stop at neutral position and allow the engine speed to return to idle.

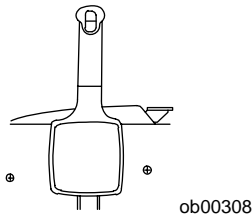

- Tiller Handle Models** - Reduce engine speed to idle before shifting.



- Always shift outboard into gear with a quick motion.
- After shifting outboard into gear, advance the remote control lever or rotate the throttle grip (tiller handle) to increase speed.

## Stopping The Engine

- Remote Control Models** - Reduce engine speed and shift outboard to neutral position. Turn ignition key to "OFF" position.

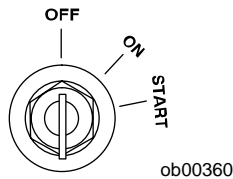

- Tiller Handle Models** - Reduce engine speed and shift outboard to neutral position. Push in the engine stop button or turn ignition key to "OFF" position.

# OPERATION

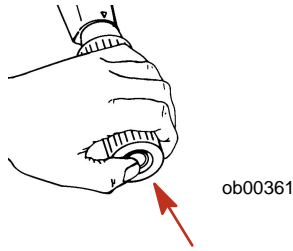

## Emergency Starting - Electric Start Models

If the starter system fails, use the spare starter rope (provided) and follow procedure.

### **WARNING**

When using emergency starter rope to start engine, the start in gear protection device is inoperative. Make sure to set the outboard gear shift into neutral to prevent outboard from starting in gear. Sudden unexpected acceleration could result in serious injury or death.

1. Shift outboard to neutral (N) position.

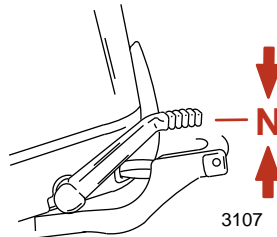
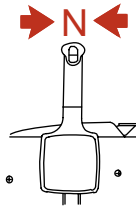

2. Set the lanyard stop switch to "RUN" position. Refer to **General Information - Lanyard Stop Switch**.

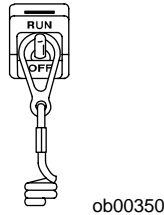

3. Turn ignition key to "ON" position.

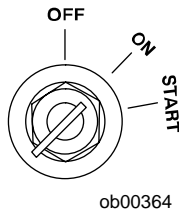

4. Remove flywheel cover.

# OPERATION

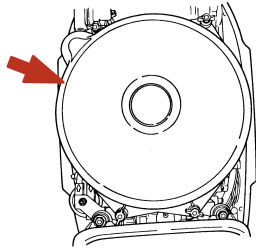

3097

## WARNING

To prevent getting an electrical shock, do not touch any ignition component, wiring, or spark plug wire when starting or running the engine.

## WARNING

The exposed moving flywheel can cause serious injury. Keep your hands, hair, clothing, tools, and other objects away from engine when starting or running the engine. Do not attempt to reinstall the flywheel cover or top cowl when engine is running.

5. If engine is cold, hold the fuel primer button in and pump up the fuel pressure with the fuel line primer bulb.

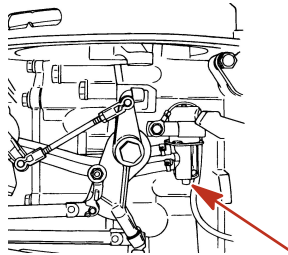

3078

6. Place the starter rope knot into the flywheel notch and wind the rope clockwise around the flywheel.
7. Pull the starter rope to start the engine.

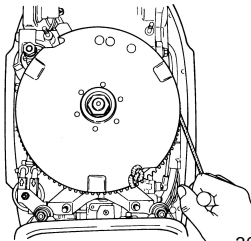

3079



# OPERATION

## Emergency Starting - Manual Start Models

If the starter system fails, use the spare starter rope (provided) and follow procedure.

### WARNING

When using emergency starter rope to start engine, the start in gear protection device is inoperative. Make sure to set the outboard gear shift into neutral to prevent outboard from starting in gear. Sudden unexpected acceleration could result in serious injury or death.

1. Shift outboard to neutral (N) position.

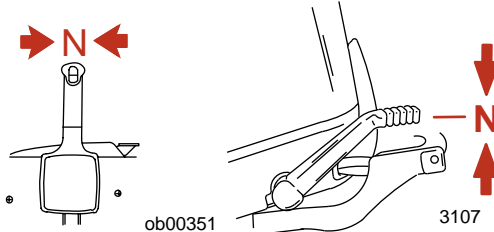

2. If starter rope is intact, pull rope out of the rewind housing and tie a knot in the rope. Remove retainer from end of rope and untie the retainer knot.

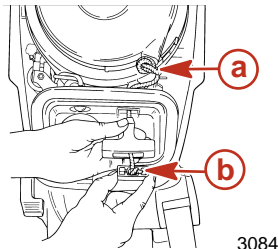

**a-** Knot

**b-** Retainer

3. Set the lanyard stop switch to "RUN" position. Refer to **General Information - Lanyard Stop Switch**.

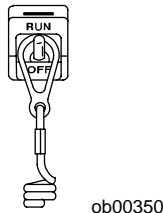

ob00350

4. Remove rewind starter.

# OPERATION

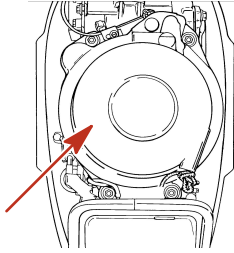

3085

## **⚠ WARNING**

To prevent getting an electrical shock, do not touch any ignition component, wiring, or spark plug wire when starting or running the engine.

## **⚠ WARNING**

The exposed moving flywheel can cause serious injury. Keep your hands, hair, clothing, tools, and other objects away from engine when starting or running the engine. Do not attempt to reinstall the rewind starter assembly or top cowl when engine is running.

5. Remote control models - Move on/off switch to the on position.



3026

6. Place starter rope knot into the flywheel notch and wind the rope clockwise around the flywheel.

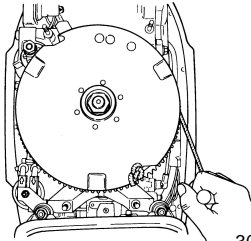

3079

7. In engine is cold, push in the fuel primer button 4 to 6 times.
8. Pull the starter rope to start the engine.

# MAINTENANCE

## Outboard Care

To keep your outboard in the best operating condition, it is important that your outboard receive the periodic inspections and maintenance listed in the Inspection and Maintenance Schedule. We urge you to keep it maintained properly to ensure the safety of you and your passengers, and retain its dependability.

### ⚠ WARNING

**Neglected inspection and maintenance service of your outboard or attempting to perform maintenance or repair on your outboard if you are not familiar with the correct service and safety procedures could cause personal injury, death, or product failure.**

Record maintenance performed in Maintenance Log at the back of this book. Save all maintenance work orders and receipts.

## SELECTING REPLACEMENT PARTS FOR YOUR OUTBOARD

We recommend using original Mercury Precision or Quicksilver replacement parts and Genuine Lubricants.

### ⚠ WARNING

**Using a replacement part that is inferior to the original part could result in personal injury, death, or product failure.**

## EPA Emissions

### EMISSION CERTIFICATION LABEL

An emission certification label, showing emission levels and engine specifications directly related to emissions, is placed on the engine at time of manufacture.

		EMISSION CONTROL INFORMATION	
This engine conforms to <input type="checkbox"/> model year EPA regulations for Marine SI engines. Refer to Owner's Manual for required maintenance.			
<b>a</b> →	IDLE SPEED: <input type="text"/>	FAMILY: <input type="text"/>	<b>f</b> →
<b>b</b> →	<input type="text"/> hp	<input type="text"/> cc	<b>g</b> →
<b>c</b> →	TIMING (IN DEGREES): <input type="text"/>	FEL: <input type="text"/> g/kWh	<b>h</b> →
<b>d</b> →	Standard spark plug: <input type="text"/>	<input type="text"/>	<b>i</b> →
	Suppressor spark plug: <input type="text"/>		
	GAP: <input type="text"/>		
<b>e</b> →	Valve Clearance (Cold) mm	Intake <input type="text"/>	
		Exhaust <input type="text"/>	

ob01071

- a** - Idle speed
- b** - Engine horsepower
- c** - Timing specification
- d** - Recommended spark plug and gap
- e** - Valve clearance (if applicable)
- f** - Family number
- g** - Maximum emission output for the engine family
- h** - Piston placement
- i** - Date of manufacture

## OWNER RESPONSIBILITY

The owner/operator is required to have routine engine maintenance performed to maintain emission levels within prescribed certification standards.

The owner/operator is not to modify the engine in any manner that would alter the horsepower or allow emissions levels to exceed their predetermined factory specifications.

# MAINTENANCE

## Inspection And Maintenance Schedule

### BEFORE EACH USE

- Check that lanyard stop switch stops the engine.
- Visually inspect the fuel system for deterioration or leaks.
- Check outboard for tightness on transom.
- Check steering system for binding or loose components.
- Remote control models - Visually check steering link rod fasteners for proper tightness. See **Steering Link Rod Fasteners**.
- Check propeller blades for damage.

### AFTER EACH USE

- Flush out the outboard cooling system if operating in salt or polluted water. See **Flushing the Cooling System**.
- Wash off all salt deposits and flush out the exhaust outlet of the propeller and gearcase with fresh water if operating in salt water.

### EVERY 100 HOURS OF USE OR ONCE YEARLY, WHICHEVER OCCURS FIRST

- Lubricate all lubrication points. Lubricate more frequently when used in salt water. See **Lubrication Points**.
- Inspect and clean spark plugs. See **Spark Plug Inspection and Replacement**.
- Check engine fuel filter for contaminants. See **Fuel System**.
- Adjust carburetors. (If required)<sup>1</sup>.
- Check engine timing setup.<sup>1</sup>.
- Check corrosion control anodes. Check more frequently when used in salt water. See **Corrosion Control Anodes**.
- Drain and replace gearcase lubricant. See **Gearcase Lubrication**.
- Lubricate splines on the driveshaft.<sup>1</sup>.
- Check power trim fluid. See **Checking Power Trim Fluid**.
- Inspect battery. See **Battery Inspection**.
- Check control cable adjustments.<sup>1</sup>.
- Remove engine deposits with Mercury Precision or Quicksilver Power Tune Engine Cleaner.
- Check tightness of bolts, nuts, and other fasteners.

### EVERY 300 HOURS OF USE OR THREE YEARS

- Replace water pump impeller (more often if overheating occurs or reduced water pressure is noted).<sup>1</sup>.

### BEFORE PERIODS OF STORAGE

- Refer to Storage procedure. See **Storage** section.

## Flushing The Cooling System

Flush the internal water passages of the outboard with fresh water after each use in salt, polluted, or muddy water. This will help prevent a buildup of deposits from clogging the internal water passages.

Use a Mercury Precision or Quicksilver accessory (or equivalent) flushing attachment.

### **WARNING**

**To avoid possible injury when flushing, remove the propeller. Refer to Propeller Replacement, following.**

1. Remove propeller. Refer to **Propeller Replacement**. Install the flushing attachment so the rubber cups fit tightly over the cooling water intake.
1. These items should be serviced by an authorized dealer.

# MAINTENANCE

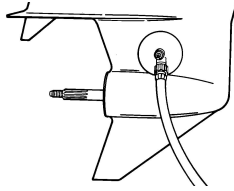

ob01604

2. Attach a water hose to the flushing attachment. Turn on the water and adjust the flow so water is leaking around the rubber cups to ensure the engine receives an adequate supply of cooling water.

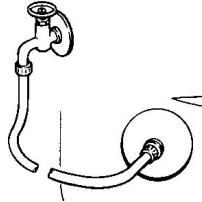

ob00570

3. Start the engine and run it at idle speed in neutral shift position.

**IMPORTANT: Do not run engine above idle when flushing.**

4. Adjust water flow (if necessary) so excess water continues leaking out from around the rubber cups to ensure the engine is receiving an adequate supply of cooling water.

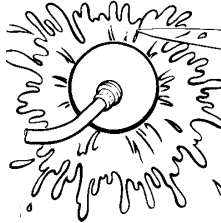

ob00571

5. Check for a steady stream of water flowing out of the water pump indicator hole. Continue flushing the outboard for 3 to 5 minutes, carefully monitoring water supply at all times.
6. Stop the engine, turn off the water, and remove the flushing attachment. Reinstall the propeller.

## Top Cowl Removal And Installation

### REMOVAL

1. Unlock the rear latch by pushing lever down.

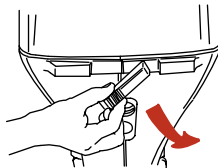

ob00368

2. Lift rear of cowl and disengage front hook.

# MAINTENANCE

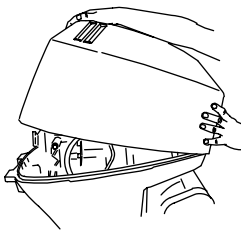

ob00369

## INSTALLATION

1. Engage the front hook and push cowl back over the cowl seal.
2. Push cowl down and move the rear latch lever up to lock.

## Battery Inspection

The battery should be inspected at periodic intervals to ensure proper engine starting capability.

**IMPORTANT: Read the safety and maintenance instructions which accompany your battery.**

1. Turn off the engine before servicing the battery.
2. Add water as necessary to keep the battery full.
3. Make sure the battery is secure against movement.
4. Battery cable terminals should be clean, tight, and correctly installed. Positive to positive and negative to negative.
5. Make sure the battery is equipped with a nonconductive shield to prevent accidental shorting of battery terminals.

## Fuel System

### WARNING

**Avoid serious injury or death from gasoline fire or explosion. Carefully follow all fuel system service instructions. Always stop the engine and do not smoke or allow open flames or sparks in the area while servicing any part of the fuel system.**

Before servicing any part of the fuel system, stop engine and disconnect the battery. Drain the fuel system completely. Use an approved container to collect and store fuel. Wipe up any spillage immediately. Material used to contain spillage must be disposed of in an approved receptacle. Any fuel system service must be performed in a well ventilated area. Inspect any completed service work for sign of fuel leakage.

## FUEL LINE INSPECTION

Visually inspect the fuel line and primer bulb for cracks, swelling, leaks, hardness, or other signs of deterioration or damage. If any of these conditions are found, the fuel line or primer bulb must be replaced.

## ENGINE FUEL FILTER

Inspect the sight bowl for water accumulation and inspect the filter element for sediment. Clean the filter as follows.

### Removal

1. Read fuel system servicing information and Warning preceding.
2. Hold on to the cover to prevent it from turning and remove the the sight bowl.
3. Pull out the filter element and wash it with cleaning solvent.

# MAINTENANCE

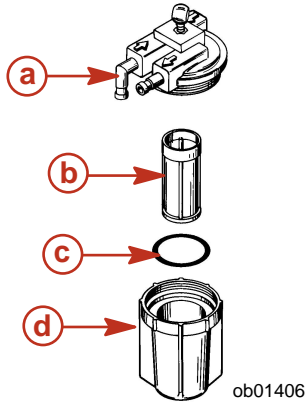
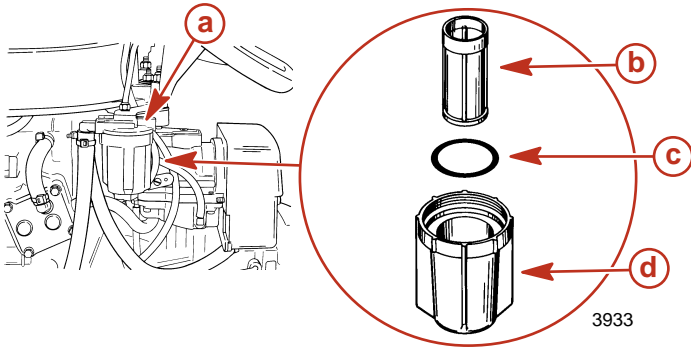

- a**- Cover
- b**- Filter element

- c**- O-ring
- d**- Sight bowl

## Installation

1. Push the filter element (with open end toward cover) into the cover.
2. Place the O-ring seal into the sight bowl and screw the sight bowl hand tight into the cover.

**IMPORTANT:** Visually inspect for fuel leakage from the filter by squeezing the primer bulb until firm, forcing fuel into the filter.

## SEA PRO/MARATHON MODELS

### Fuel Pump Filter

## WARNING

Avoid serious injury or death from gasoline fire or explosion. Carefully follow all fuel system service instructions. Always stop the engine and do not smoke or allow open flames or sparks in the area while servicing any part of the fuel system.

1. Remove the filter.

# MAINTENANCE

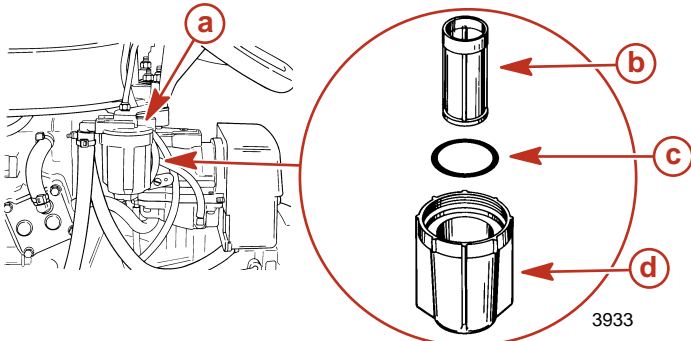

- a** - Cover
- b** - Filter

- c** - O-ring seal
- d** - Sight bowl

2. Wash sight bowl and filter in cleaning solvent.

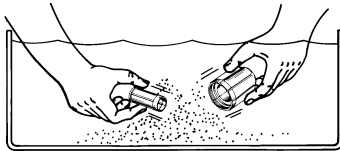

3806

## Carburetor Fuel Bowl

### **⚠ WARNING**

Avoid serious injury or death from gasoline fire or explosion. Carefully follow all fuel system service instructions. Always stop the engine and do not smoke or allow open flames or sparks in the area while servicing any part of the fuel system.

1. Loosen main jet plug on side of carburetor 1 turn to drain fuel.

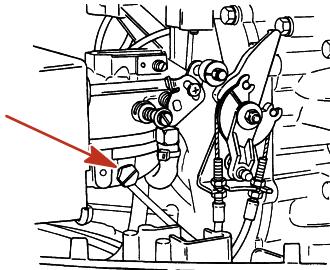

3938

2. Dispose of fuel properly.



# MAINTENANCE

## CARBURETOR ADJUSTMENTS

### Slow Speed Mixture Adjustment

1. Before starting engine, turn the slow speed mixture screw in until it is lightly seated then back it out 1-1/4 turns.

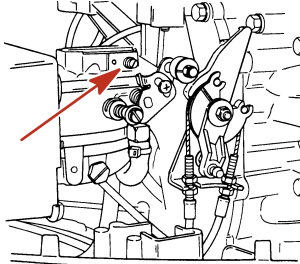

3951

2. With boat tied securely to dock, start engine and allow it to warm up.
3. Shift the outboard into forward gear while maintaining idle speed.

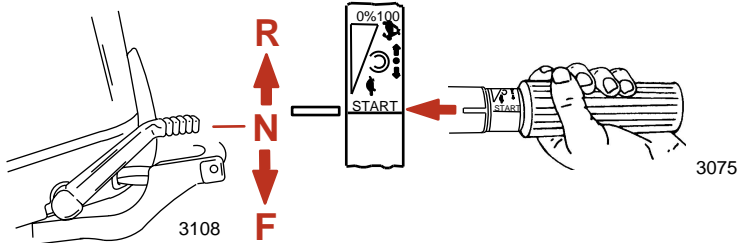

4. Turn the slow speed mixture screw slowly in until the engine starts to misfire or stall due to a lean mixture. Note the position of the screw slot.
5. Turn the slow speed mixture screw slowly out until the engine starts to load up or fire unevenly due to a rich mixture. Note the position of the screw slot.
6. Set the slow speed mixture screw midway between the rich and lean setting. When in doubt, set the mixture slightly rich rather than too lean.

### Engine Idle Speed Adjustment

1. With boat tied securely to dock, start engine and allow it to warm up.
2. Shift the outboard into forward gear while maintaining idle speed.

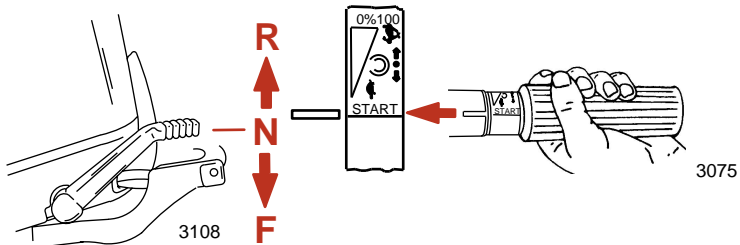

3. Adjust the idle speed screw to obtain the recommended engine idle speed. Refer to **General Information - Specifications**.

# MAINTENANCE

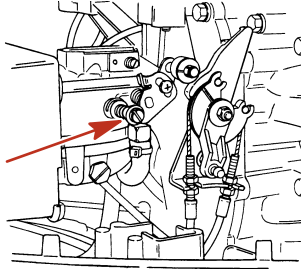

## High Speed Mixture Adjustment

The carburetor is equipped with a standard size high speed fixed jet that is replaceable for operation at higher elevations. See an authorized dealer.

## Exterior Care

Your outboard is protected with a durable baked enamel finish. Clean and wax often using marine cleaners and waxes.

## Steering Link Rod Fasteners

**IMPORTANT:** The steering link rod that connects the steering cable to the engine must be fastened using special washer head bolt ("a" - Part Number 10-856680) and self-locking nylon insert locknuts ("b" & "e" - Part Number 11-826709113). These locknuts must never be replaced with common nuts (non-locking) as they will work loose and vibrate off, freeing the link rod to disengage.

### **WARNING**

Disengagement of a steering link rod can result in the boat taking a full, sudden, sharp turn. This potentially violent action can cause occupants to be thrown overboard exposing them to serious injury or death.

Assemble steering link rod to steering cable with two flat washers and nylon insert locknut. Tighten locknut until it seats, then back nut off 1/4 turn.

Assemble steering link rod to engine with special washer head bolt, locknut and spacer. First torque bolt to specifications, then torque locknut to specifications.

# MAINTENANCE

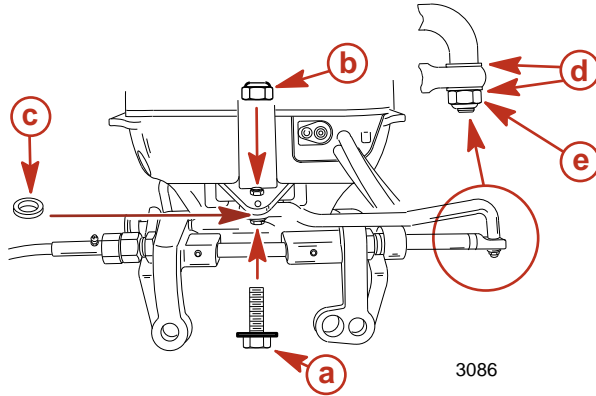

- a-** Special washer head bolt (10-856680)
- b-** Nylon insert locknut (11-826709113)
- c-** Spacer
- d-** Flat washers
- e-** Nylon insert locknut (11-826709113)

Description	Nm	lb. in.	lb. ft.
Special washer head bolt	27		20
Nylon insert locknut "b"	27		20
Nylon insert locknut "e"	Tighten until seats, then back off 1/4 turn		

## Fuse Replacement - Electric Start Models

**IMPORTANT: Always carry spare SFE 20 AMP fuses.**

The electric starting circuit is protected from overload by an SFE 20 AMP fuse. If the fuse is blown, the electric starter motor will not operate. Try to locate and correct the cause of the overload. If the cause is not found, the fuse may blow again.

1. Open the fuse holder and look at the silver colored band inside the fuse. If band is broken, replace the fuse. Replace fuse with a new fuse with the same rating.

# MAINTENANCE

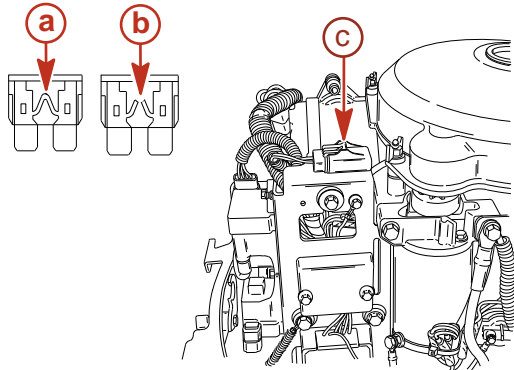

3087

- a- Good band
- b- Broken band

- c- Fuse holder

## Corrosion Control Anode

The outboard has corrosion control anodes at different locations. An anode helps protect the outboard against galvanic corrosion by sacrificing its metal to be slowly eroded instead of the outboard metals.

Each anode requires periodic inspection, especially in salt water which will accelerate the erosion. To maintain this corrosion protection, always replace the anode before it is completely eroded. Never paint or apply a protective coating on the anode as this will reduce effectiveness of the anode.

The trim tab on the gearcase is a corrosion control anode. Models that have a longer transom bracket will have another anode installed on the bottom of the transom bracket assembly.

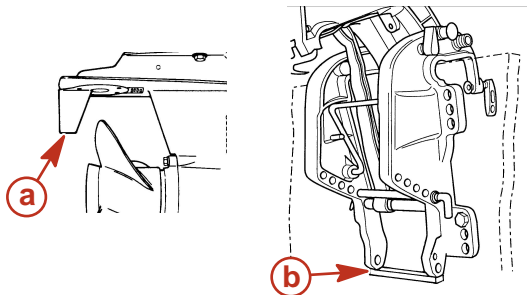

3088

- a- Trim tab anode

- b- Transom bracket anode

## Propeller Replacement

### **WARNING**

If the propeller shaft is rotated while the engine is in gear, there is the possibility that the engine will crank over and start. To prevent this type of accidental engine starting and possible serious injury caused from being struck by a rotating propeller, always shift outboard to neutral position and remove spark plug leads when you are servicing the propeller.

1. Shift outboard to neutral (N) position.

# MAINTENANCE

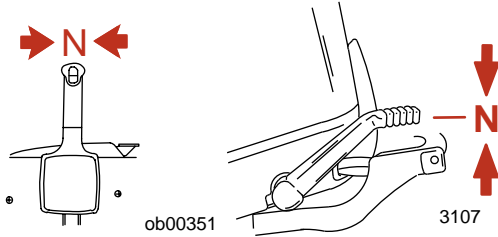

2. Remove the spark plug leads to prevent engine from starting.

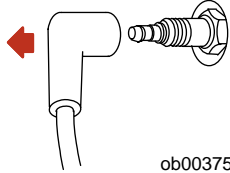

3. Straighten the bent tabs on the propeller nut retainer.

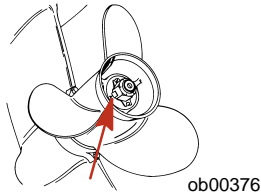

4. Place a block of wood between gearcase and propeller to hold propeller and remove propeller nut.

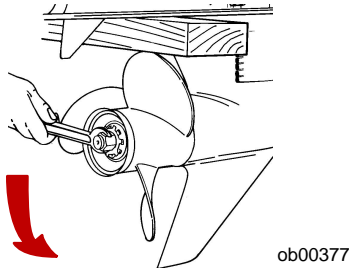

5. Pull propeller straight off shaft. If propeller is seized to the shaft and cannot be removed, have the propeller removed by an authorized dealer.
6. Coat the propeller shaft with Quicksilver or Mercury Precision Lubricants Anti-Corrosion Grease or 2-4-C with Teflon.

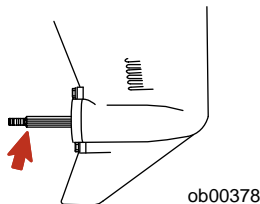

# MAINTENANCE

**IMPORTANT:** To prevent the propeller hub from corroding and seizing to the propeller shaft (especially in salt water), always apply a coat of the recommended lubricant to the entire propeller shaft at the recommended maintenance intervals, and also each time the propeller is removed.

7. Flo-Torq I Drive Hub Propellers - Install forward thrust hub, propeller, propeller nut retainer, and propeller nut onto the shaft.

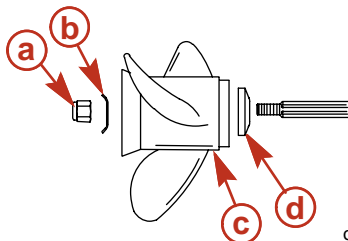

ob00379

- a- Propeller nut
- b- Propeller nut retainer
- c- Propeller
- d- Forward thrust hub

8. Place propeller nut retainer over pins. Place a block of wood between gearcase and propeller and tighten propeller nut to specifications, aligning flat sides of the propeller nut with tabs on the propeller nut retainer.

Description	Nm	lb. in.	lb. ft.
Propeller nut	75		55

9. Secure propeller nut by bending tabs up and against the flats on the propeller nut.

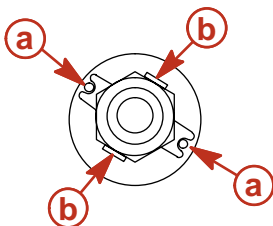

ob00381

- a- Pins
- b- Tabs

10. Reinstall spark plug leads.

## Spark Plug Inspection And Replacement

### ⚠ WARNING

Avoid serious injury or death from fire or explosion caused by damaged spark plug boots. Damaged spark plug boots can emit sparks. Sparks can ignite fuel vapors under the engine cowl. To avoid damaging spark plug boots, do not use any sharp object or metal tool such as pliers, screwdriver, etc. to remove spark plug boots.

1. Remove the spark plug boots. Twist the rubber boots slightly and pull off.

# MAINTENANCE

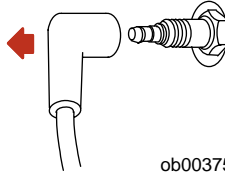

ob00375

- Remove the spark plugs to inspect. Replace spark plug if electrode is worn or the insulator is rough, cracked, broken, blistered or fouled.



ob00423

- Set the spark plug gap to specification.

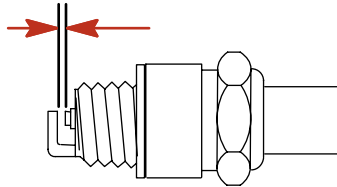

ob00424

Spark Plug	
Spark plug gap	1.0 mm (0.040 in.)

- Before installing spark plugs, clean off any dirt on the spark plug seats. Install plugs finger tight, and then tighten 1/4 turn or torque to specifications.

Description	Nm	lb. in.	lb. ft.
Spark plug	27		20

## Lubrication Points

- Lubricate the following with Quicksilver or Mercury Precision Lubricants Anti-Corrosion Grease or 2-4-C with Teflon.
  - Propeller Shaft - Refer to **Propeller Replacement** for removal and installation of the propeller. Coat the entire propeller shaft with lubricant to prevent the propeller hub from corroding and seizing to the shaft.

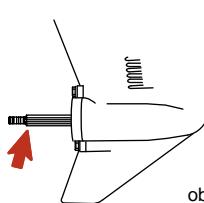

ob00378

# MAINTENANCE

- Lubricate the following with Quicksilver or Mercury Precision Lubricants 2-4-C with Teflon or Special Lubricant 101.

- Swivel Bracket - Lubricate through fitting.

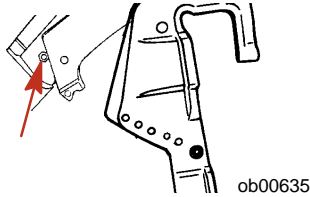

- Tilt Tube - Lubricate through fitting.
- Co-Pilot Shaft (Tiller Handle Models) - Lubricate through fitting. Move the steering friction lever back and forth while lubricating.

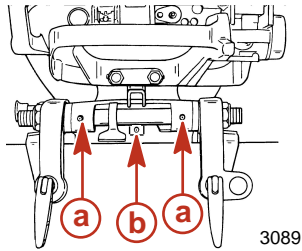

**a-** Tilt Tube

**b-** Co-pilot shaft

- Lubricate threads of transom clamp screws (if equipped).

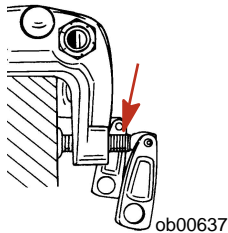

- Shift Handle (Tiller Handle Models) - Lubricate through fittings.

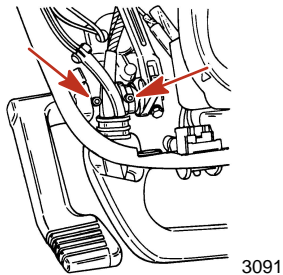

- Steering Cable Grease Fitting (If equipped) - Rotate steering wheel to fully retract the steering cable end into the outboard tilt tube. Lubricate through fitting.



# MAINTENANCE

## ⚠ WARNING

The end of the steering cable must be fully retracted into the outboard tilt tube before adding lubricant. Adding lubricant to steering cable when fully extended could cause steering cable to become hydraulically locked. A hydraulically locked steering cable will cause loss of steering control, possibly resulting in serious injury or death.

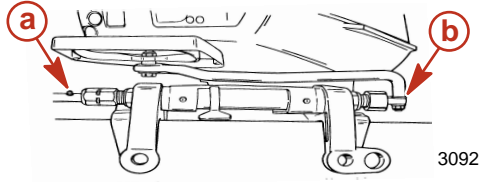

**a -** Fitting

**b -** Steering cable end

- Lubricate the following with light weight oil.
  - Steering Link Rod Pivot Points - Lubricate points.

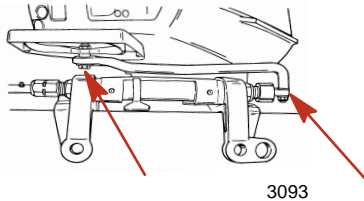

3093

## Checking Power Trim Fluid

- Tilt outboard to the full up position and push in the tilt support pin.

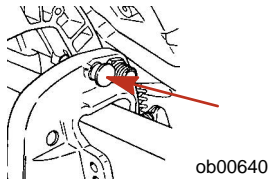

ob00640

- Remove fill cap and check fluid level. The fluid level should be even with the bottom of the fill hole. Add Quicksilver or Mercury Precision Lubricants Power Trim & Steering Fluid. If not available, use automotive (ATF) automatic transmission fluid.

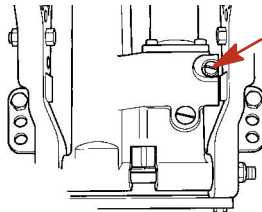

ob00641

# MAINTENANCE

## Gearcase Lubrication

When adding or changing gearcase lubricant, visually check for the presence of water in the lubricant. If water is present, it may have settled to the bottom and will drain out prior to the lubricant, or it may be mixed with the lubricant, giving it a milky colored appearance. If water is noticed, have the gearcase checked by your dealer. Water in the lubricant may result in premature bearing failure or, in freezing temperatures, will turn to ice and damage the gearcase.

Examine the drained gearcase lubricant for metal particles. A small amount of metal particles indicates normal gear wear. An excessive amount of metal filings or larger particles (chips) may indicate abnormal gear wear and should be checked by an authorized dealer.

## DRAINING GEARCASE

1. Place outboard in a vertical operating position.
2. Place a drain pan below outboard.
3. Remove vent plug and fill/drain plug and drain lubricant.

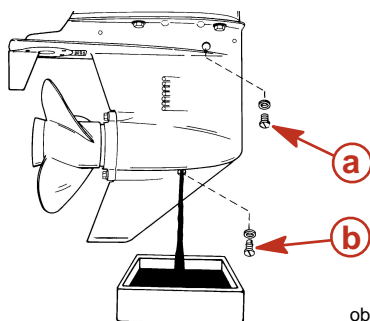

ob00439

**a -** Vent plug

**b -** Fill/drain plug

## GEARCASE LUBRICANT CAPACITY

Gearcase lubricant capacity is approximately 440 ml (14.9 fl. oz.).

## GEARCASE LUBRICANT RECOMMENDATION

Mercury or Quicksilver Premium or High Performance Gear Lubricant.

## CHECKING LUBRICANT LEVEL AND REFILLING GEARCASE

1. Place outboard in a vertical operating position.
2. Remove vent plug.

# MAINTENANCE

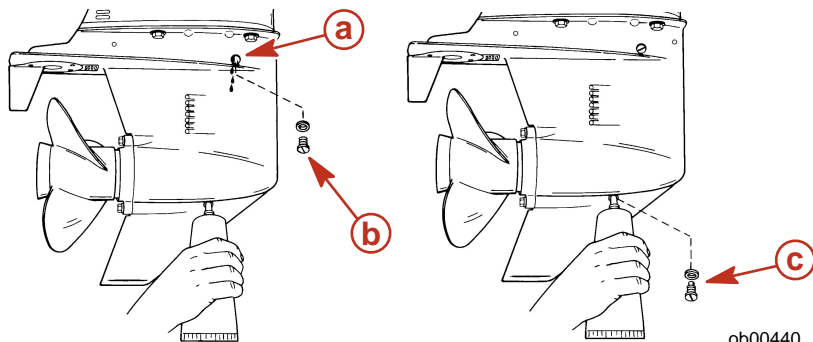

a - Vent hole

b - Vent plug

c - Fill/drain plug

ob00440

3. Place lubricant tube into the fill hole and add lubricant until it appears at the vent hole.

**IMPORTANT: Replace sealing washers if damaged.**

4. Stop adding lubricant. Install the vent plug and sealing washer before removing the lubricant tube.
5. Remove lubricant tube and reinstall cleaned fill/drain plug and sealing washer.

## Submerged Outboard

A submerged outboard will require service within a few hours by an authorized dealer once the outboard is recovered from the water. This immediate attention by a servicing dealer is necessary once the engine is exposed to the atmosphere to minimize internal corrosion damage to the engine.

# STORAGE

## Storage Preparation

The major consideration in preparing your outboard for storage is to protect it from rust, corrosion, and damage caused by freezing of trapped water.

The following storage procedures should be followed to prepare your outboard for out of season storage or prolonged storage (two months or longer).

### CAUTION

**Never start or operate your outboard (even momentarily) without water circulating through all the cooling water intake holes in the gearcase to prevent damage to the water pump (running dry) or overheating of the engine.**

## FUEL SYSTEM

**IMPORTANT: Gasoline containing alcohol (ethanol or methanol) can cause a formation of acid during storage and can damage the fuel system. If the gasoline being used contains alcohol, it is advisable to drain as much of the remaining gasoline as possible from the fuel tank, remote fuel line, and engine fuel system.**

Fill the fuel tank and engine fuel system with treated (stabilized) fuel to help prevent formation of varnish and gum. Proceed with following instructions.

- Portable Fuel Tank - Pour the required amount of gasoline stabilizer (follow instructions on container) into fuel tank. Tip fuel tank back and forth to mix stabilizer with the fuel.
- Permanently Installed Fuel Tank - Pour the required amount of gasoline stabilizer (follow instructions on container) into a separate container and mix with approximately one quart (one liter) of gasoline. Pour this mixture into fuel tank.
- Place the outboard in water or connect flushing attachment for circulating cooling water. Run the engine for ten minutes to fill the engine fuel system.

## Protecting External Outboard Components

- Lubricate all outboard components listed in **Maintenance - Inspection and Maintenance Schedule**.
- Touch up any paint nicks. See your dealer for touch-up paint.
- Spray Quicksilver or Mercury Precision Lubricants Corrosion Guard on external metal surfaces (except corrosion control anodes).

## Protecting Internal Engine Components

**NOTE: Make sure the fuel system has been prepared for storage. Refer to Fuel System, preceding.**

**IMPORTANT: Refer to Maintenance - Spark Plug Inspection and Replacement for correct procedure for removing spark plug boots.**

- Place the outboard in water or connect flushing attachment for circulating cooling water. Start the engine and let it run in neutral to warm up.
- With engine running at fast idle, stop the fuel flow by disconnecting the remote fuel line. When engine begins to stall, quickly spray Quicksilver or Mercury Precision Lubricants Storage Seal into carburetor until engine stops from lack of fuel.
- Remove the spark plugs and inject a five second spray of storage seal around the inside of the cylinder.
- Rotate the flywheel manually several times to distribute the storage seal in the cylinder. Reinstall spark plug.

## Gearcase

- Drain and refill the gearcase lubricant (refer to **Maintenance - Gearcase Lubrication**).

## Positioning Outboard For Storage

Store outboard in an upright (vertical) position to allow water to drain out of outboard.

# STORAGE

## CAUTION

If outboard is stored tilted up in freezing temperature, trapped cooling water or rain water that may have entered the propeller exhaust outlet in the gearcase could freeze and cause damage to the outboard.

### Battery Storage

- Follow the battery manufacturer's instructions for storage and recharging.
- Remove the battery from the boat and check water level. Recharge if necessary.
- Store the battery in a cool, dry place.
- Periodically check the water level and recharge the battery during storage.

# TROUBLESHOOTING

## Starter Motor Will Not Crank The Engine (Electric Start Models)

### POSSIBLE CAUSES

- Remote control models - Blown 20 Amp fuse in the starting circuit. Refer to **Maintenance** section.
- Outboard is not shifted to neutral position.
- Weak battery or battery connections are loose or corroded.
- Ignition key switch failure.
- Wiring or electrical connection faulty.
- Starter motor or starter solenoid failure.

## Engine Will Not Start

### POSSIBLE CAUSES

- Lanyard stop switch not in "RUN" position.
- Incorrect starting procedure. Refer to **Operation** section.
- Old or contaminated gasoline.
- Engine flooded. Refer to **Operation** section.
- Fuel is not reaching the engine.
  - a. Fuel tank is empty.
  - b. Fuel tank vent not open or restricted.
  - c. Fuel line is disconnected or kinked.
  - d. Primer bulb not squeezed.
  - e. Primer bulb check valve is faulty.
  - f. Fuel filter is obstructed. Refer to **Maintenance** section.
  - g. Fuel pump failure.
  - h. Fuel tank filter obstructed.
- Ignition system component failure.
- Spark plugs fouled or defective. Refer to **Maintenance** section.

## Engine Runs Erratically

### POSSIBLE CAUSES

- Spark plugs fouled or defective. Refer to **Maintenance** section.
- Incorrect setup and adjustments.
- Fuel is being restricted to the engine.
  - Engine fuel filter is obstructed. Refer to **Maintenance** section.
  - Fuel tank filter obstructed.
  - Stuck anti-siphon valve on built in fuel tank.
  - Fuel line is kinked or pinched.
- Fuel pump failure.
- Ignition system component failure.

## Performance Loss

### POSSIBLE CAUSES

- Throttle not fully open.
- Damaged or improper size propeller.
- Incorrect engine timing, adjustments, or setup.
- Boat overloaded or load improperly distributed.

# TROUBLESHOOTING

- Excessive water in bilge.
- Boat bottom is dirty or damaged.

## **Battery Will Not Hold Charge**

### **POSSIBLE CAUSES**

- Battery connections are loose or corroded.
- Low electrolyte level in battery.
- Worn out or inefficient battery.
- Excessive use of electrical accessories.
- Defective rectifier, alternator, or voltage regulator.

# OWNER SERVICE ASSISTANCE

## Local Repair Service

Always return your outboard to your local authorized dealer should the need for service arise. Only he has the factory trained mechanics, knowledge, special tools, equipment, and genuine parts and accessories to properly service your engine should the need occur. He knows your engine best.

## Service Away From Home

If you are away from your local dealer and the need arises for service, contact the nearest authorized dealer. Refer to the Yellow Pages of the telephone directory. If, for any reason, you cannot obtain service, contact the nearest Mercury Marine Service Office.

## Parts And Accessories Inquiries

All inquiries concerning genuine replacement parts and accessories should be directed to your local authorized dealer. The dealer has the necessary information to order parts and accessories for you. When inquiring on parts and accessories, the dealer requires the model and serial number to order the correct parts.

## Service Assistance

Your satisfaction with your outboard product is very important to your dealer and to us. If you ever have a problem, question or concern about your outboard product, contact your dealer or any authorized Mercury Marine dealership. If additional assistance is required, take these steps.

1. Talk with the dealership's sales manager or service manager. If this has already been done, then contact the owner of the dealership.
2. Should you have a question, concern, or problem that cannot be resolved by your dealership, please contact Mercury Marine Service Office for assistance. Mercury Marine will work with you and your dealership to resolve all problems.

The following information will be needed by the service office:

- Your name and address
- Daytime telephone number
- Model and serial number of your outboard
- The name and address of your dealership
- Nature of problem

## Mercury Marine Service Offices

For assistance, call, fax, or write. Please include your daytime telephone number with mail and fax correspondence.

United States		
Telephone	(920) 929-5040	Mercury Marine W6250 W. Pioneer Road P.O. Box 1939 Fond du Lac, WI 54936-1939
Fax	(920) 929-5893	
Website	www.mercurymarine.com	

Canada		
Telephone	(905) 567-6372	Mercury Marine Ltd. 2395 Meadowpine Blvd. Mississauga, Ontario L5N 7W6 Canada
Fax	(905) 567-8515	



# OWNER SERVICE ASSISTANCE

<b>Australia, Pacific</b>		
Telephone	(61) (3) 9791-5822	Mercury Marine Australia 132-140 Frankston Road Dandenong, Victoria 3164 Australia
Fax	(61) (3) 9793-5880	

<b>Europe, Middle East, Africa</b>		
Telephone	(32) (87) 32 • 32 • 11	Marine Power - Europe, Inc. Parc Industriel de Petit-Rechain B-4800 Verviers, Belgium
Fax	(32) (87) 31 • 19 • 65	

<b>Mexico, Central America, South America, Caribbean</b>		
Telephone	(954) 744-3513	Mercury Marine 11650 Interchange Circle North Miramar, FL 33025 U.S.A.
Fax	(954) 744-3535	

<b>Japan</b>		
Telephone	81-053-423-2500	Mercury Marine - Japan Anshin-cho 283-1 Hamamatsu Shizuoka-ken, Japan 435-0005 Japan
Fax	81-053-423-2510	

<b>Asia, Singapore</b>		
Telephone	5466160	Mercury Marine Singapore 72 Loyang Way Singapore, 508762
Fax	5467789	