

UTTERN D77 MODEL YEAR 2017

[Parts catalog](#)



Revision history

25th of November 2015

7th of March 2016

11th of March 2016

12th of April 2016

4th of July 2016

D77 MECHANICAL SYSTEMS

AFT BILGE PUMP SYSTEM



INT 1760963
PUMP BILGE SAHARA 500

INT 263954
HOSE CLAMP #10

INT 1692922
3/4" ID CORR PVC WATER HOSE

INT 2037135
THRU-HULL, PLAS SSCAP 3/4 "S



FORWARD BILGE PUMP SYSTEM

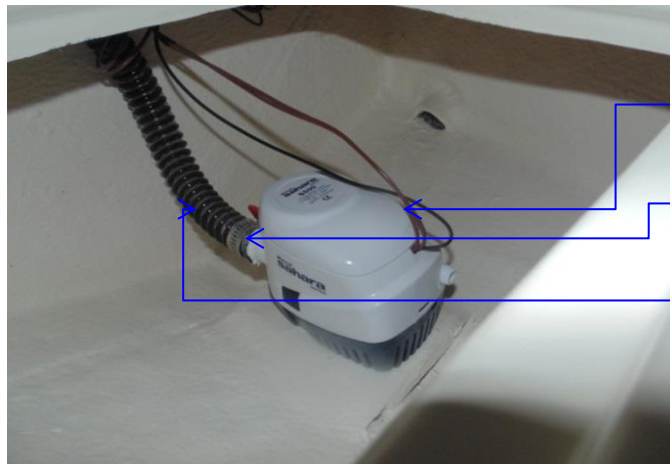

INT 1760963
PUMP BILGE SAHARA 500

INT 263954
HOSE CLAMP #10

INT 1692922
3/4" ID CORR PVC WATER HOSE

INT 2037135
THRU-HULL, PLAS SSCAP 3/4 "S



FUEL SYSTEM

INT 123489
HOSE CLAMP #24

INT 263954
HOSE CLAMP #10

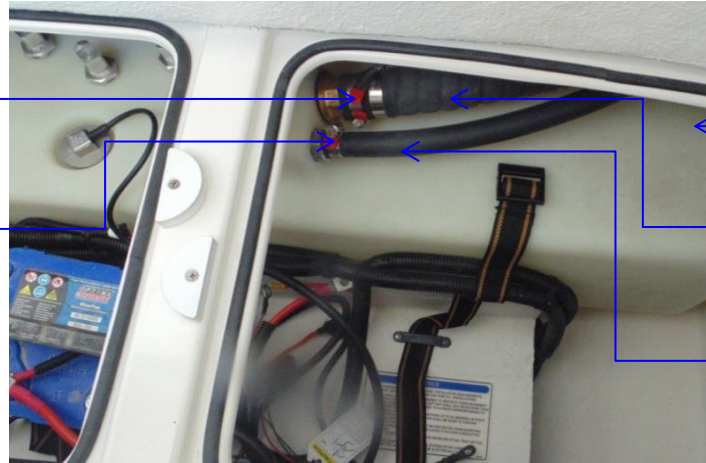

INT 2147513
TANK, FUEL 280L TEE PEX

INT 2017535
HOSE, FUEL 1.5" ISO/SAE A2COR

INT 123778
HOSE, FUEL 5/8" TYPE A1 ISO/C



INT 1971016
DECK PLATE GAS CHR W/VENT STRAIGHT

INT 1497452
TAPE FOAM NEOPRENE

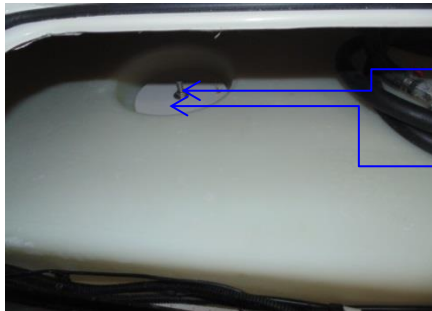
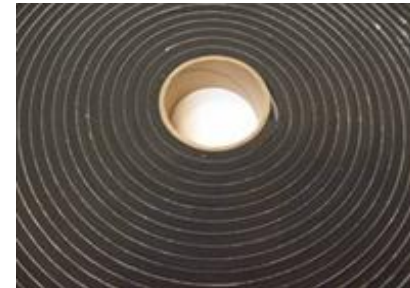

INT 1978985
267MM FUEL TANK BRACKET

INT 1978962
TANK CLEAT 140

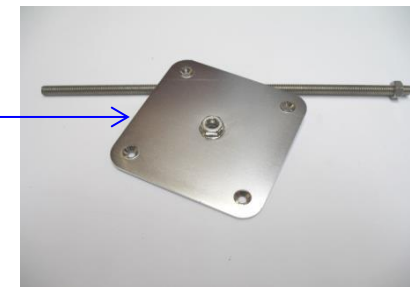

INT 2081605
BRACKET, 230MM FUEL TANK

COCKPIT DRAIN SYSTEM



INT 1741022
THRU HULL, 1.5" STALON SCUPPE

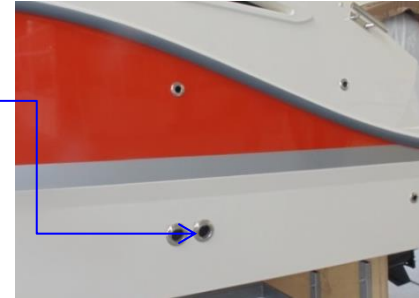

INT 1727536
THRU-HULL- PLAS 3/4 BARB L-H



INT 2101136
THRU-HULL,PLAS 1.5"X90D TPR HD

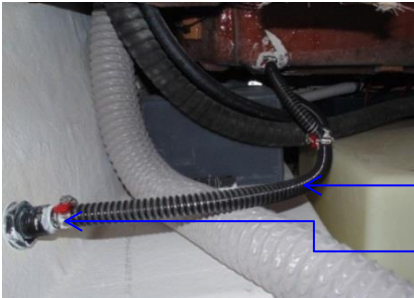

INT 1692922
3/4" ID CORR PVC WATER HOSE

INT 263954
HOSE CLAMP #10

INT 1692954
HOSE PVC 1.5WHITE





INT 1823043
TEE, 3/4" BLACK #625



INT 2078069
DRAIN,IMPACT 3/4"FLUSH HEAD EIBOW



INT 2037135
THRU-HULL,PLAS SSCAP 3/4"SHT



UTE 873642
3/4" THRU-HULL FITTING PLASTIG

INT 2101136
THRU-HULL,PLAS 1.5"X90D TPR HD

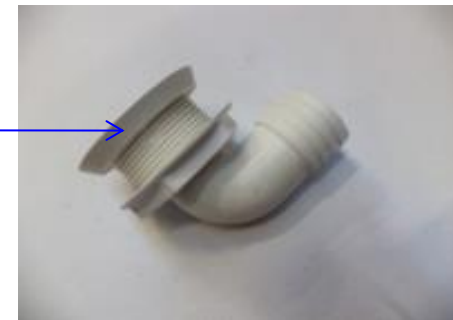

INT 123489

HOSE CLAMP #24

INT 830968

COVER CLAMP END1/2X0450

INT 830976

COVER CLAMP END 1/2X035X30

VENTILATION BOX DRAIN SYSTEM



UTE 873642
3/4" THRU-HULL FITTING PLASTIG

INT 1699463
THRU HULL, PLASTIC 3/4" X 90 DEG.

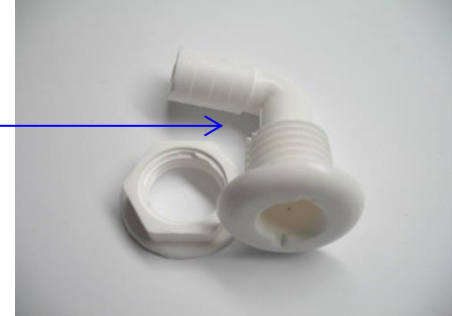

INT 1692922
3/4" ID CORR PVC WATER HOSE

INT 263954
HOSE CLAMP #10

INT 830968
COVER CLAMP END 1/2 X 0450

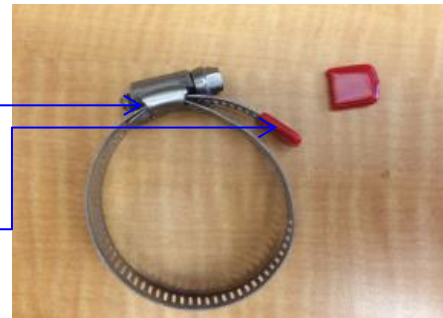

DASH DRAIN SYSTEM



INT 1702191
DRAIN FITTING 1/4"6MM

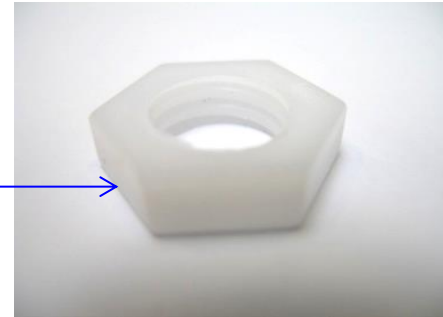

INT 1702192
NUT, JAM PLAS 1/2" FOR 1702191



INT 124347
HOSE, PVC CLEAR 3/8"

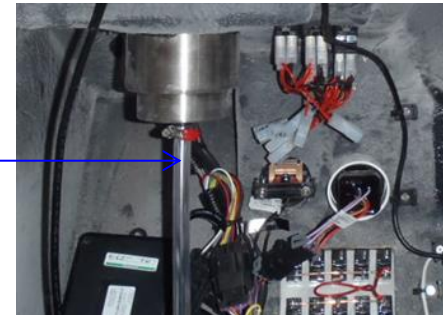

INT 123398
HOSE CLAMP #6

INT 830968
COVER CLAMP END1/2X0450

WATER SYSTEM

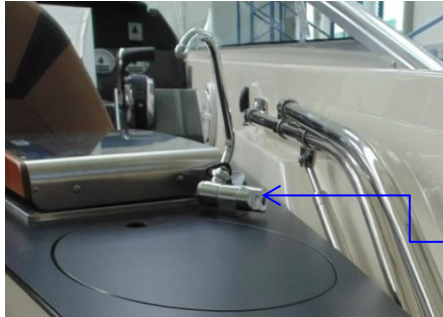

INT 2118435
FAUCET COLD WATER

INT 2118496
ADAPTER, 3/8"BSP 15MM PLAS

INT 1693275
ELBOW ADAPTER 1/2BSP 15MM

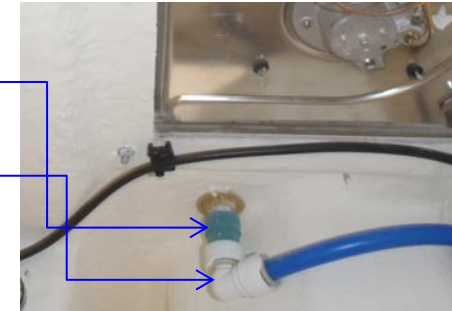

INT 1971019
DECK PLATE,WTR CHR W/VENT

INT 1693251
TEE EQUAL 15MMX15MMX15MM

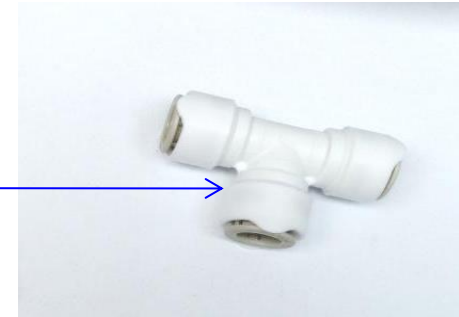

INT 2147514
TANK, WATER 80L BOX

INT 1693249
ELBOW, EQUAL15MMX15MM

INT 490219
HOSE, CORR SAN/WATER-FILL



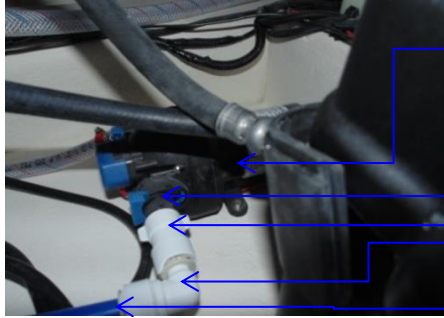

INT 1947087

PUMP, PORTABLE WATER 2.9 G

INT 1942968

ADAPTER, PLAS 1/2"THRDR STR

INT 1693253

ADAPTER FML 1/2" TO 15MM

INT 1693275

ELBOW ADAPTER 1/2"BSP 15MM

INT 1929686

MDPE TUBE 15MM BLUE

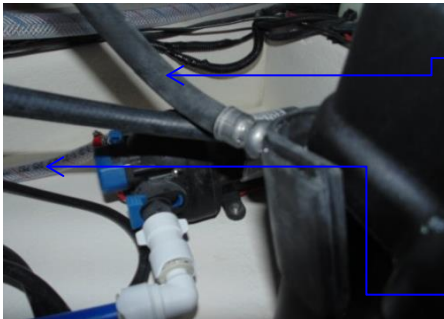

INT 124412

HOSE, PVC5/8" CLEAR W/B

INT 2064898

ADAPTER, PLAS 1/2"BARB STRAIGHT

* located on opposite side of the pump

INT 2067032

HOSE, PVC 1/2" CLEAR W/BLUE/RED

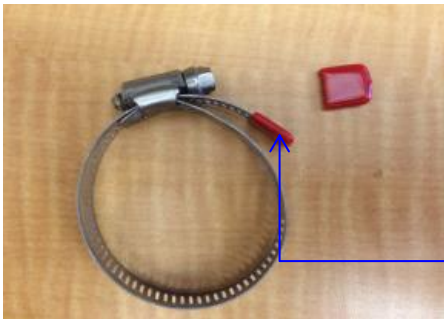
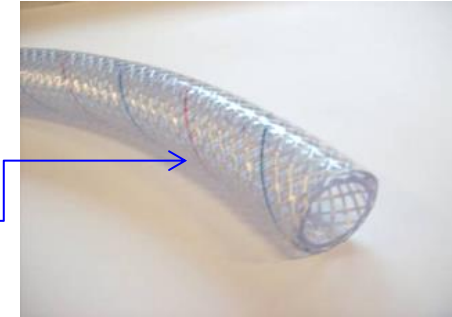

INT 123398

HOSE CLAMP #6

INT 263954

HOSE CLAMP #10

INT 123489

HOSE CLAMP #24

INT 830968

COVER CLAMP END1/2X0450

INT 830976

COVER CLAMP END 1/2X035X30

INT 1915911

FILTER, IN-LINE
WATER STN



WASTE SYSTEM



INT 263954
HOSE CLAMP #10

INT 1934547
HEAD, MANUAL RH COMPACT/T

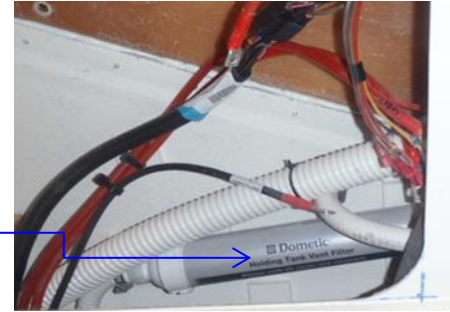

INT 2049172
FILTER,CARBON FOR WASTE SYSTEM

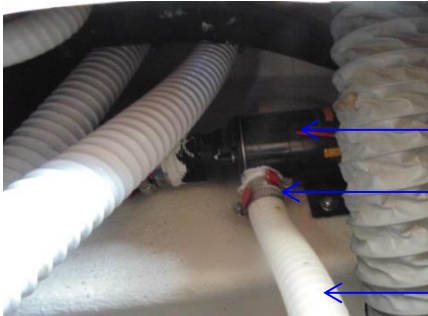

INT 1857992
PUMP, MACERATOR 13 GPM,12V

INT 2111292
CLAMP HOSE NR16 SS

INT 1694239
HOSE- SANI 1 ID WHITE



INT 2037135
THRU-HULL,PLAS SSCAP 3/4"S

INT2118404
TANK,WASTE 27.8L GRY W/CLE

UTE 870602
TANKSTRAP 1.5 M

INT1702532
CLEAT,SEAT 4" BLK



INT 2112302
ELBOW,MARELON1.5"MPTX1.5"B

INT 846899
HOSE, SANI 1.5" PREMIUM R

INT 123489
HOSE CLAMP #24



INT 1971021
DECK PLATE,WASTE CHR STRAI

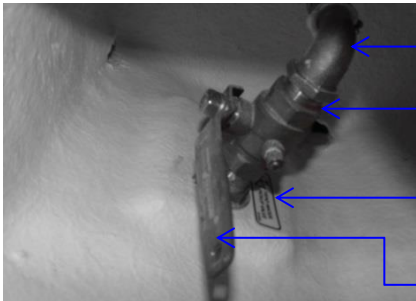

INT 1702035
ELBOW, BRASS 3/4" MPT X 3/4" BARB

INT 1701381
BARB, BRASS 3/4" MPT W/1,5"

INT 2016958
HEAD WATER PICKUP VALVE LAB

INT 1703616
VALVE, BALL 3/4" W/GND SCR

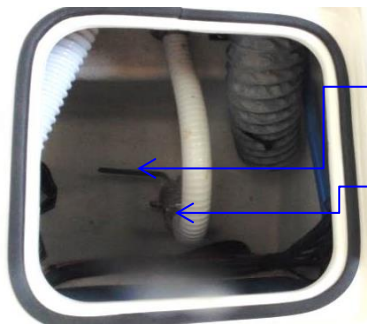
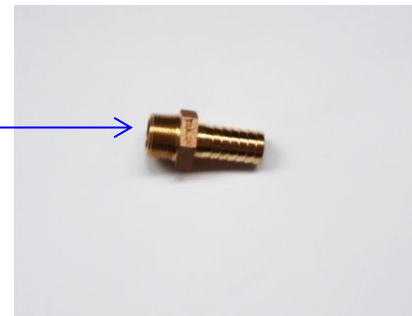

INT 1703694
VALVE 1" BALL

INT 1704767
ADAPTER, BRZ 1" MPT X 1" BARB

INT 2118445
THRU-HULL BRZ 1" W-HEX NUT



UTE 877020
HOSE WASTE 19MM

INT 2016961
OVERBOARD DISCHARGE VALVE L

INT 1843338
PICKUP, 3/4" WATER STRAIN



VENTILATION SYSTEM



INT 1577949
HOSE, VENT/ BLOWER3" WHITE

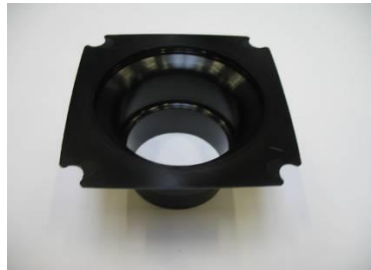

INT 875860MANCHON
PROTECTION SLEEVE/VENTIL GRATE

INT 830698 COVER, CLAMP END 1/2"X.045"X

INT 830976 COVER, CLAMP END 1/2"X.035"

STANDARD STEERING WHEEL



UTE 877101
STEER. WHEEL FERARRA 800 BLACK

D77 ELECTRICAL SYSTEMS

HULL ELECTRICAL



INT 808775
BOX-BATTERY @6 13X9X10

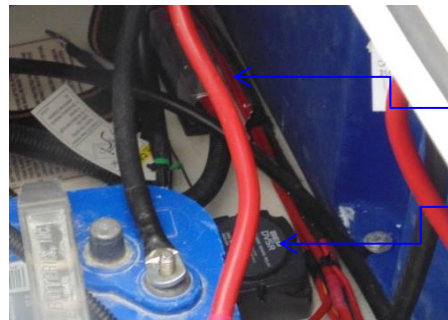

INT 2155980
BUSS BAR, 4 X 5/16" STUDS

UTE 877238
RELAY CHARGING DUAL BATTERY



Q/S 859223A01
+SENSOR-SPEED/TEMP TRANSOM

INT 2111296
HARNESS, VESSEL SC FUEL/PADDLE

DECK ELECTRICAL



UTE 875119
ROUND BASE FOR POLE WHITE

INT 1734685
LIGHT-NAV A/R STERN84 F

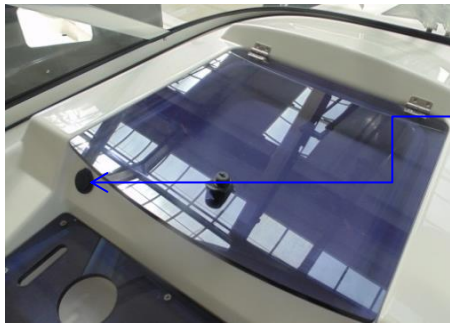

UTE 873748
SOCKET 12V ROUND FLUSH MOUNT

INT 875374
SIDELIGHTS SS 2 MI



INT 1911089
LIGHT, STEP WHT LED 12/24



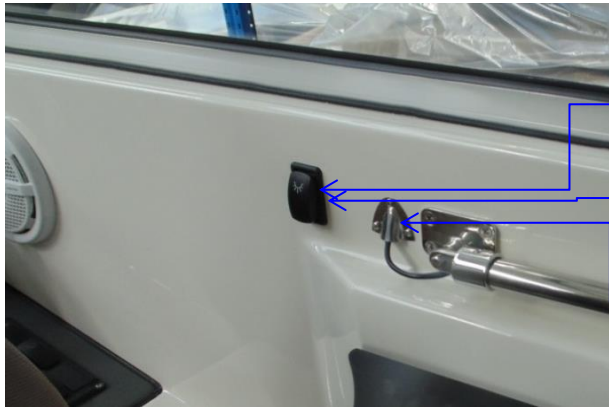

INT 2148856
ACTUATOR, COURTESY LIGHT

UTE 871343
FRAME FOR EL.PANEL SINGEL

UTE 874770
CLAMSHELL COVER STAINLESS



UTE 871336
MAIN SWITCH ON/OFF W/O PUSH

INT 2081250
HORN, MARINE
DROPINHIDDEN12VBLK



INT 2148020 HARNESS, MAIN EN/CD

CABIN ELECTRICAL



INT 2063848
CO MONITOR, CMD-4EOL WHT

INT 1782156
PLATE, CO MONITORBCKNG WHT

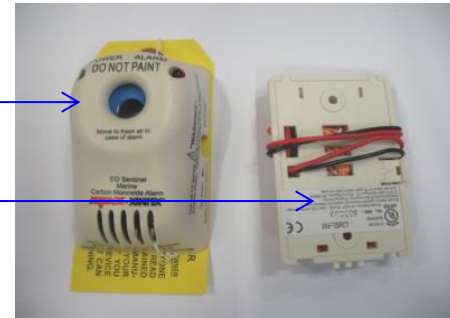

UTE 873748
SOCKET 12V ROUND FLUSH MOUNT



INT 1911089
LIGHT, STEP WHT LED 12/24



INT 2118477
LIGHT, LED COMET SWITCHED



INT 2082022
LAMP, CEILING 12V SWITCHED CHR

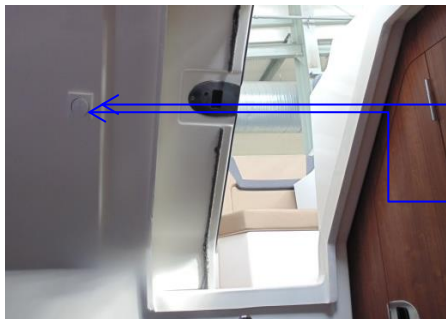

INT 2118476
SWITCH,DOUBLE LIGHT

INT 2118664
SWITCH FRAME, 1 GANG POLAR WHI

DASH ELECTRICAL



UTE 873748
SOCKET 12V ROUND FLUSH MOUNT



INT 2150655
PANEL, GAUGE



INT 2148021
PANEL, DC BREAKER PANEL

Q/S 859318T2*
JUNCTION BOX WEATHER CAP

Q/S 878492T14 *
JUNCTION BOX 4-WAY

Q/S 892453A01*
CABLE ASY-ADAPT FEMALE/FE

Q/S 1128345*
SPACER-.26 X .50 X .45

* p/n available from HIN BE-UTBEN006J617



INT 2148022
PANEL, SWITCH EN/CD

UTT D77 COMPONENT ASSEMBLY

ANCHOR LINE LOCKER HATCH

D77ANCHORHT-APA
(LAM+ HARDWARE)

INT 879DEL442
D77 ANCHOR LINE LOCKER HATCH LAM

INT 1896799
HINGE, DRAFTED BUTT SS3"X2

INT 674358
CYLINDER GAS 40PSI 20EXTX12COM

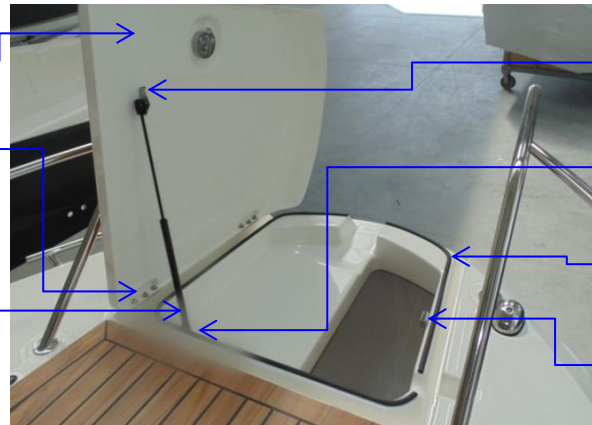

INT 634550
BRACKET MOUNT SS ANGLE 2"11/16"

INT 634592
BRACKET MOUNT SS FLAT

INT 1232156
TRIM-SEAL, #X1333BT ST F-ADH BLACK

INT 2176301
CATCH, DRAW LATCH FLUSH SS



INT 1781437
LATCH, COMPRESSION
2"N/LOCK



INT 1781440
PLATE, DEEP BRKT \\
2"W/HDWR P



INT 1781439
CATH, PAWL 2" OFFSET
SHORT S

PORT FORWARD SEAT HATCH

INT D77PFWDSTHT-APA
(LAM+ HARDWARE)



INT 879DEL443
D77 PORT FWD SEATHATCH LAM

INT 1896799
HINGE, DRAFTED BUTT SS3"X2



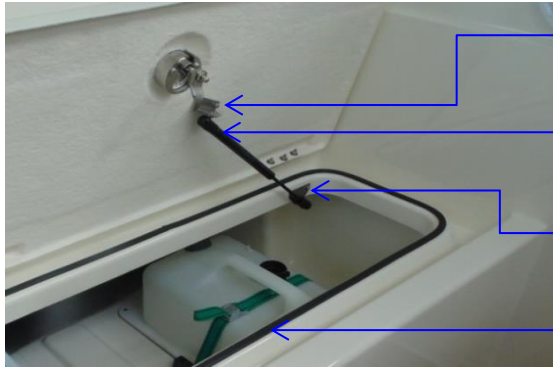

INT 634550
BRACKET MOUNT SS ANGLE 2"11/16"

INT 2072356
CYLINDER, GAS 30PSI 12.04" EXT X 8

INT 634592
BRACKET MOUNT SS FLAT

INT 1232156
TRIM-SEAL, #X1333BT ST F-ADH BLACK



INT 1916867
LATCH, COMPRESSION
2" LOCK I



INT 1781439
CATH, PAWL 2" OFFSET
SHORT S



INT 1781440
PLATE, DEEP BRKT \\
2"W/HDWR P

CABIN ENTRY DOOR ASSEMBLY



INT 1978559
LOCK, SS ENTRY DOOR OVAL

INT 1232156
TRIM-SEAL,#X1333BT ST F-ADH BLACK

INT 2148056
LATCH- DOOR ENTRY/WINDOW S

INT 2148862
DOOR HDWR SLIDING TRACK 123CM

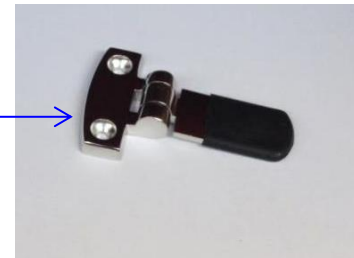

INT 1701595
BUMPER GLASS DOOR 12948-0

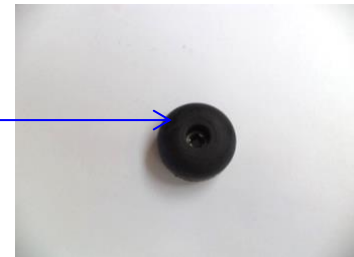

INT 1809076
DOOR HARDWARE WHISKERS SEAL GREY

INT 826453
SHIM,DOOR STRIKER

AFT LOUNGE SEAT BACK

INT D77ALNGSTBK-APA
(LAM+ HARDWARE)



INT 879DEL444
D77 AFT LOUNGE

INT 2151893
RAIL, SS SEAT BACK



INT 2148061
ACTUATOR, PADDLE PLSRC/AL

INT 1039247
BUMPER, 3/4"DIA X 1/4"THK

INT 2151894
HINGE, FOLDING ST LH

INT 2151896
HINGE, FOLDING ST RH



INT 2165338
SCREW, DIN 965 A4M3 X 45



INT 875682
STICKY WASHER 12/6.5*1



INT 2161857
BRACKET CABLE HANDLE SS



INT 2161853
SPRING,CMP50X10X1.2WIRE

INT 1979172 CABLE 280/310 DUAL AFT SEA

INT 2176300 WASHER, NYLON 38MMX21MMX1MM

AFT LOUNGE SEAT HATCH

INT D77ALNGSTHT-APA
(LAM+ HARDWARE)

INT 879DEL445
AFT LOUNGE SEAT HATCH LAM

INT 634550
BRACKET MOUNT SS ANGLE 2"11/16"

INT 634592
BRACKET MOUNT SS FLAT

INT 1232156
TRIM-SEAL,#X1333BT ST F-ADH BLACK

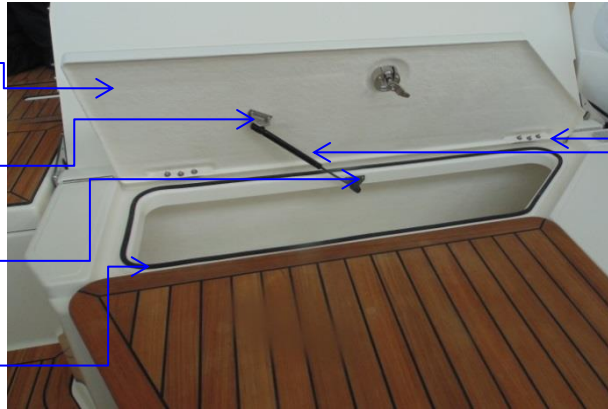

INT 1896799
HINGE, DRAFTED BUTT SS3"X2

INT 1074780
CYLINDER, GAS 40PSI 12.

INT 1916867
LATCH, COMPRESSION
2" LOCKI

INT 1781439
CATH, PAWL 2" OFFSET
SHORT S

INT 1781440
PLATE, DEEP BRKT \
2"W/HDWR P

PORT LOUNGE SEAT HATCH

INT D77PLNGSTHT-APA
(LAM+ HARDWARE)

INT 879DEL446
PRT LOUNGE SEAT HATCH LAM

INT 634550
BRACKET MOUNT SS ANGLE 2"11/16"

INT 634592
BRACKET MOUNT SS FLAT

INT 1232156
TRIM-SEAL#X1333BT ST F-ADH BLACK

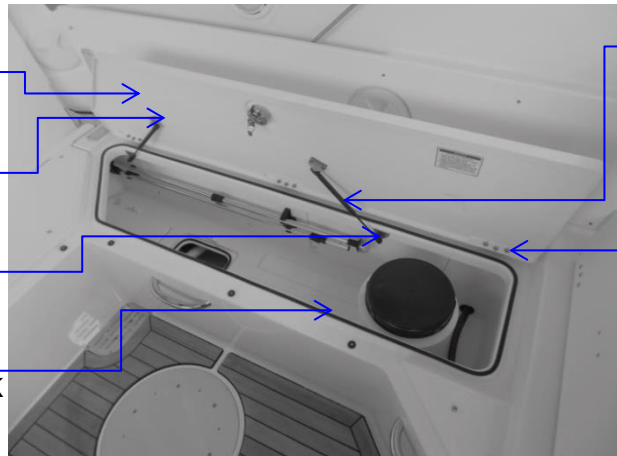

INT 1074780
CYLINDER, GAS 40PSI 12.

INT 1896799
HINGE, DRAFTED BUTT SS3"X2

INT 1916867
LATCH, COMPRESSION
2" LOCKI

INT 1781439
CATH, PAWL 2" OFFSET
SHORT S

INT 1781440
PLATE, DEEP BRKT \
2"W/HDWR P

MOTORWELL STEP

→ **INT D77BRDGESTP-APA**
(LAM+ HARDWARE)

INT 879DEL447
D77 MOTOR WELL STSTEP LAM

INT 2101144
CYLINDER,GAS30LB17.2'EXTX1

INT 1232156
TRIM-SEAL,#X1333BT
ST F-ADH BLACK

INT 2176301
CATCH,DRAW LATCH FLUSH SS

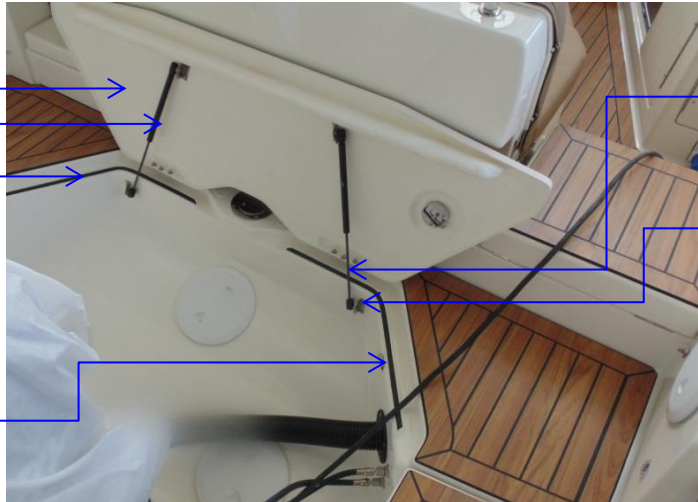

INT 1896799
HINGE, DRAFTED BUTT SS3"X2

INT 634550
BRACKET MOUNT SS
ANGLE2"11/16"



INT 1781437
LATCH, COMPRESSION
2"N/LOCK



INT 1781440
PLATE, DEEP BRKT \\
2"W/HDWR P



INT 1781439
CATH, PAWL 2" OFFSET
SHORT S

CANVAS STORAGE PORT HATCH

INT D77CANVASHT-APA
(LAM+ HARDWARE)



INT 879DEL449
D77 CANVAS STOR PRT HATCH LAM

INT 1781437
LATCH, COMPRESSION
2"N/LOCK

INT 1781440
PLATE, DEEP BRKT \\
2"W/HDWR P

INT 1781439
CATH, PAWL 2" OFFSET
SHORT S

INT 1916867
LATCH, COMPRESSION
2" LOCKI



INT 2148062
COVER, SS CANVAS STORAGE H

INT 2148054
HINGE, SS BUTT 4"X4" CAST

INT 1232156
TRIM-SEAL,#X1333BT ST F-ADH BLACK

INT 2148057
STRIKER, LATCH SS

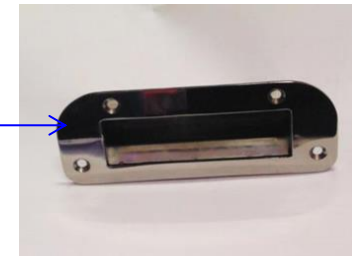

LADDER COVER



INT 879DEL450
LADDER COVER

CANVAS STORAGE STARBOARD HATCH

INT D77CANVASSHT-AP
(LAM+ HARDWARE)



INT 879DEL451
D77 CANVAS STOR STB HATCH

INT 1692956
SCREW, MACHINE #10-24X5/

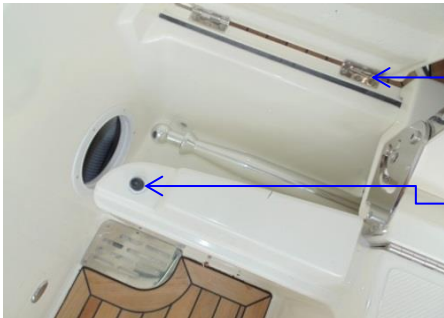

INT 1896799
HINGE, DRAFTED BUTT SS3"X2

INT 1690487
STOP, MINI HOLDERRBR BLK

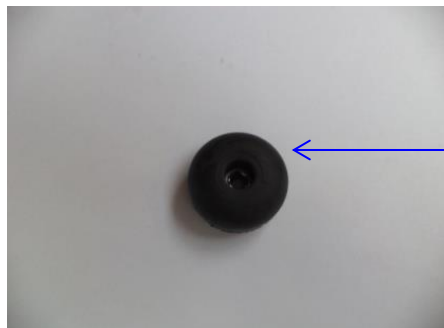

INT 1039247
BUMPER, 3/4"DIA X 1/4"THK

INT 1798594
NUT, BBL #10-24X 3/8"TH SS

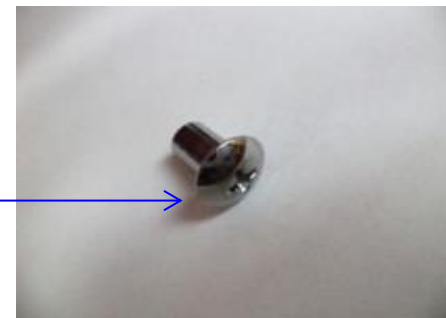

PORT SWIM PLATFORM HATCH

INT D77PSWIMHT-APA



INT 879DEL452
D77 PRT SWIM PLTF HATCH LAM

INT 1690487
STOP, MINI HOLDERRBR BLK

INT 1896799
HINGE, DRAFTED BUTT SS3"X2

INT 1232156
TRIM-SEA INT 1039247



INT 1692956
SCREW, MACHINE #10-24X5/



INT 1798594
NUT, BBL #10-24X 3/8"TH SS



INT 1039247
BUMPER, 3/4"DIA X 1/4"THK

STARBOARD DASH



INT 1878489
DRINK HOLDER SSDC 70300

INT 1232156
TRIM-SEAL,#X1333BT ST F-ADH BLACK



INT 2148863
FOREDECK ENTRY/DASH SUPPORT RAIL

D77 HULL HARDWARE

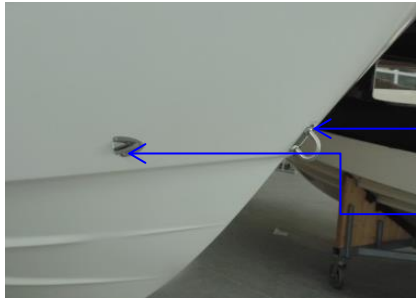

INT 2088144
EYE,BOW 316SS 1/2"X2 5/8"

INT 875335001INOX
S.S MIDGET VENT

INT 2088145
ANCHOR DEADEND W13 MM HOLE



INT 2088143
EYE, BOW 316SS 1/2"X3 7/8"

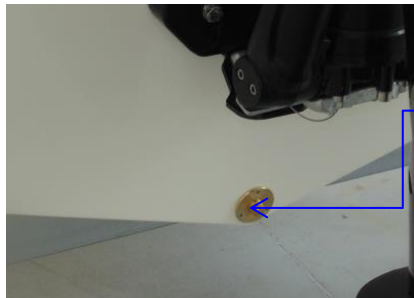

INT 126615
GARBOARD DRAIN, BRASS PLU

INT 875682
STICKY WASHER 12/6.5*1



INT 2086306
BUMPER,CLEAR RND 12MMDIAX3.5MMTALL

INTERIOR FLOOR LINER



INT 879DEL453
D77 FWD BERTH ASS FWD

INT 879DEL454
D77 FWD BERTH ASS PORT

INT 879DEL455
D77 FWD BERTH ASS MIDD

INT 879DEL456
D77 FWD BERTH ASS STB

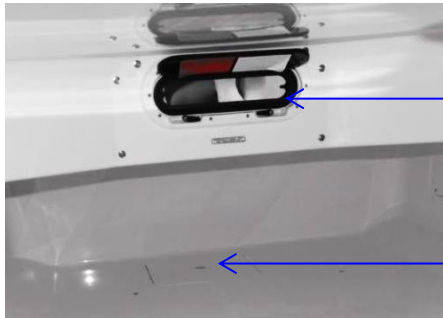

INT 2100526
PORTLIGHT OPENING6"X14"OVAL PL

INT 879DEL484
D77/805 AFT BERTH BILGE PUMP ACCES



INT 879DEL485
D77/805 AFT BERTH BAT CHARG AC

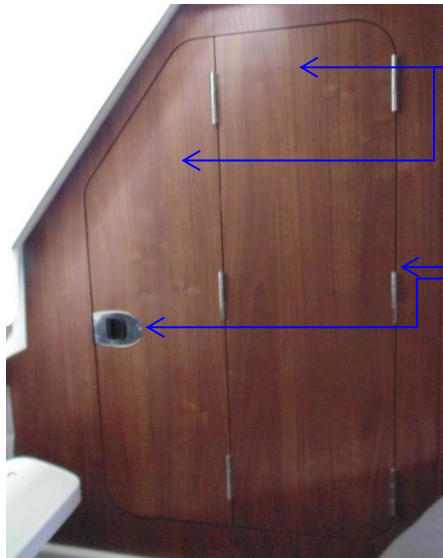

INT 879DEL457
 D77 ENCLOSED HEAD DOOR
 ONLY WOOD WITHOUT HINGE AND LATCH

INT 2082191
 HINGE, SS NON-MORTICE 3.8

INT 1846523
 LATCH, COMPACT 5/8 SATIN NIC

INT 2041384
 LOOP, 1/2" VELCOIN

INT 2155982
 BRACKET, 108 DEG CORNER

INT 2127761
 SCREW, MACH FHSS 1/4-20X 5/8"

INT 2118427
 PORTLIGHT, OVAL 5-9/16X14-1/1

INT 879DEL458
 D77 ENCL HEAD PANEL

INT 879DEL459
 D77 HEAD ACCESS

INT 2106822
 NUT, SS BBL PTH5/16 DIA X 3/4 X 1/4-

INT 2082090
 STRIKER, SS 5MM N/DUSTBI

INT 2156000
 COCKPIT SUPPORT/ENTRY WAY STAI

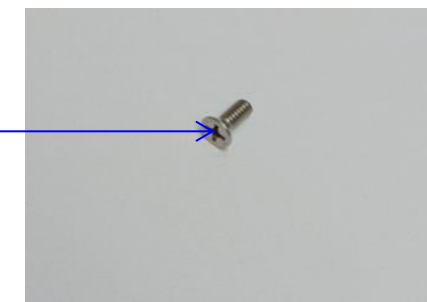
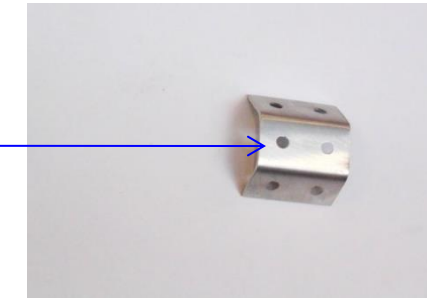
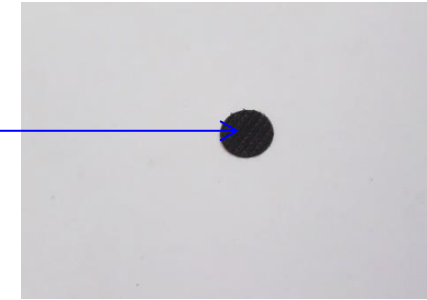

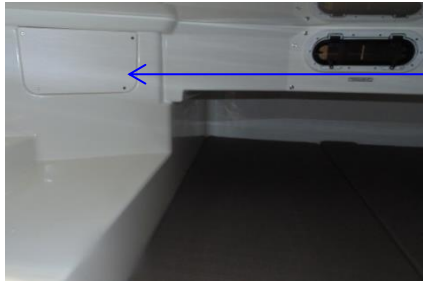

INT 879DEL463
D77 ROOF LINER STBD ACCESS



INT 879DEL462
D77 ROOF LINER PORT ACCESS



INT 879DEL461
D77 ROOF LINER HEAD ACCESS



INT 879DEL460
ROOF LINER AFT BERTH



INT 2026923
DECK PLATE, SCREW IN 188MM
** hidden under the mirror*



INT 875330WHITE
PLASTIC PLUG WHITE



INT 879DEL486
D77/805 FWD BERTH MIRROR P



INT 2118395
EDGE BAND, PVC WALNUT

INT 1232156

TRIM-SEAL, #X1333BT ST F-A

INT 1698881

ANGLE-3/4X3/4 W/.19 HOLE

INT 2155996

O-RING,-008EPDM

D77 DECK HARDWARE

DECK ASSEMBLY

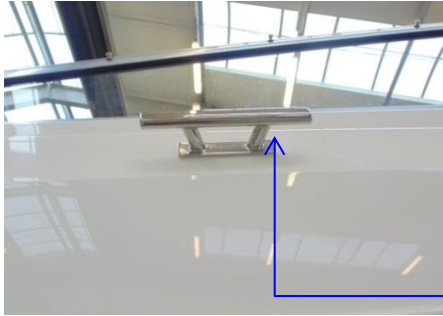

INT 2026923
DECK PLATE, SCREW IN 188MM



UTE 873463
CLEAT SS 205X55MM



UTE 871702
FLAG HOLDER SS

UTE 871758
GRABRAIL SS 200 MM





INT 2148083
RAIL, BOW STBD

INT 2118401
HATCH, DECK 17X17 FLUSH

INT 879DEL487
D77/805 STB FOREDECK WINDOW

INT 879DEL488
D77/805 PORT FOREDECK WINDOW

INT 2148082
RAIL, BOW PORT

INT 2127788
NUT, TEE M6X12.3
4 PRONG S

INT 875682
STICKY WASHER
12/6.5*1



INT 2156001
SUPPORT, PORT LOUNGE SEAT

INT 2152199
ACCESS PLATE, 127MM ID

INT 2155992
STANDOFF SS 4MM X12.4

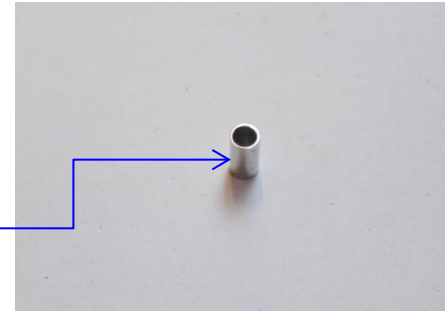

INT 2148065
TRIM RING, SCRN 17"X17"X1

INT 2124965
SCREEN, HATCH 17" X 17"





INT 1979176
BACKING PLATE SECURITY EYE

INT 2170073
HATCH, INSP180X280RM VBL DOOR W

INT 2148049
DRAIN, SS GRATE

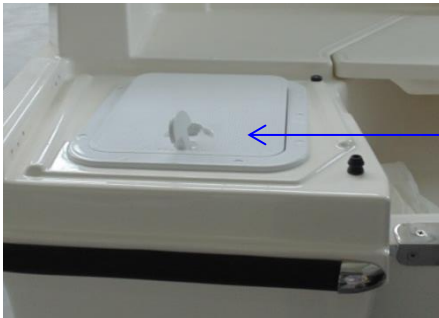

UTE 874706
FIRE EXTINGUISHER PRIMEX 2

INT 875396
HATCH 306MM X 356MM

UTE 874782
DRIVER SEAT BASE 35/52



INT 1907894
CLIP, POLE STRG BLK - MAST LIGHT

UTE 874770
CLAMSHELL COVER STAINLESS



INT 2161855
BASE, CANVAS CLEVIS 90



INT 875904
INOX U-BOLT HEAT TREATED C

WINDSHIELD



INT 2148074
WINDSHIELD, PORT

INT 2148075
WINDSHIELD, CTR

INT 2148076
WINDSHIELD, STBD

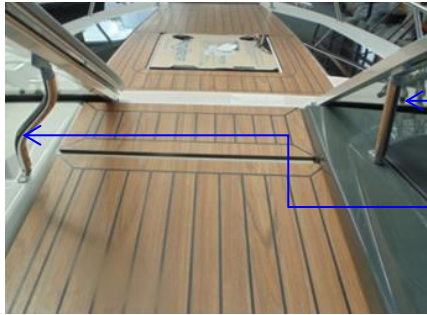

INT 2155989
WINDSHIELD,SUPPORT PRT TU

INT 2155988
WINDSHIELD, SUPPORT PRT T

INT 2148875
WINDSHIELD, INSTALL KIT



INT 1762533
BRACE,W/S BASE FT7/8" TU

INT 153171
MACHINE 1/4-20X2" PFH 18-8

INT 1762534
BRACE, W/S 7/8" SCKET TU

INT 2101149
WASHER,NYLON 6MM I.DX12MM

INT 2155981
BRACKET, SS PORT WS SUPPOR

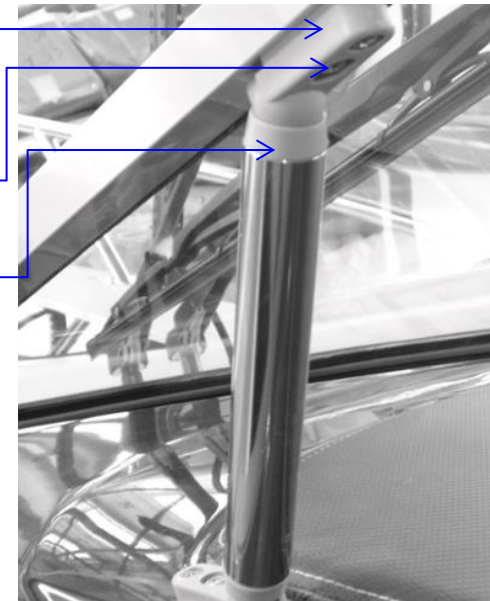

INT 1703244
CONN, 7/8" TUBE 1/4-20



INT 1693420
SPACER, .49OB X 26ID X .



- | | | |
|----|--------------------|----------------------------|
| 1. | INT 1703244 | CONN, 7/8" TUBE 1/4-20 |
| 2. | INT 1693420 | SPACER, .490B X 26ID X . |
| 3. | INT 153171 | MACHINE 1/4-20X2" PFH 18-8 |
| 4. | INT 2161861 | TUBE, W/S CENTER PANEL STA |
| 5. | INT 1701595 | BUMPER GLASS DOOR 12948- |

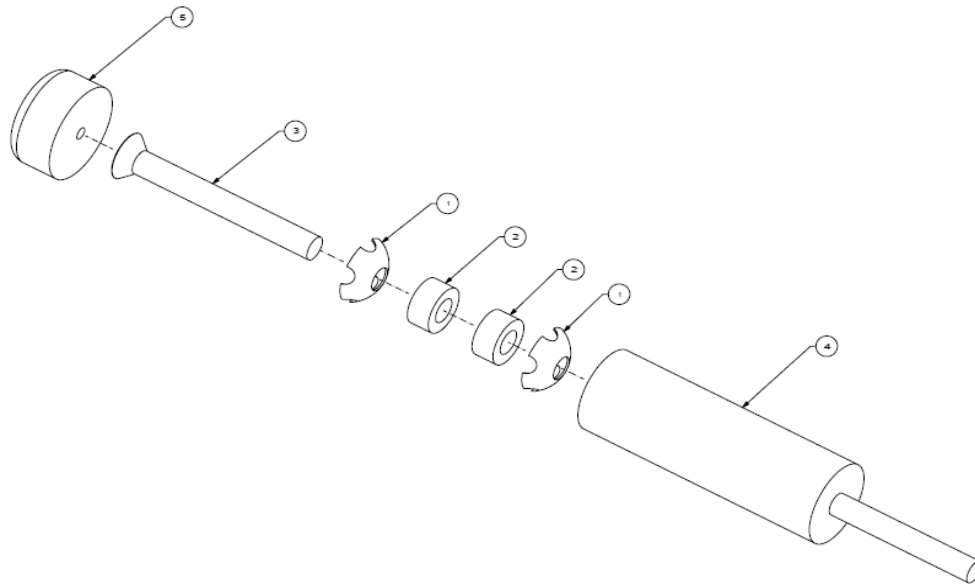

WINDSHIELD WIPERS



INT 2149466
BLADE 508MM FLEX, BLACK

INT 2149465
WIPER, ARM

INT 2156026
WIPER, SPRAY KIT



INT 2149464
WIPER MOTOR

INT 2149468
WIPER WASHER, RESERVOIR KIT



INT 2156025
WIPER, WASCHER BLKHD FTG

INT 2160403

HOSE, PVC CLEAR 7OD 4ID

PORT DASH

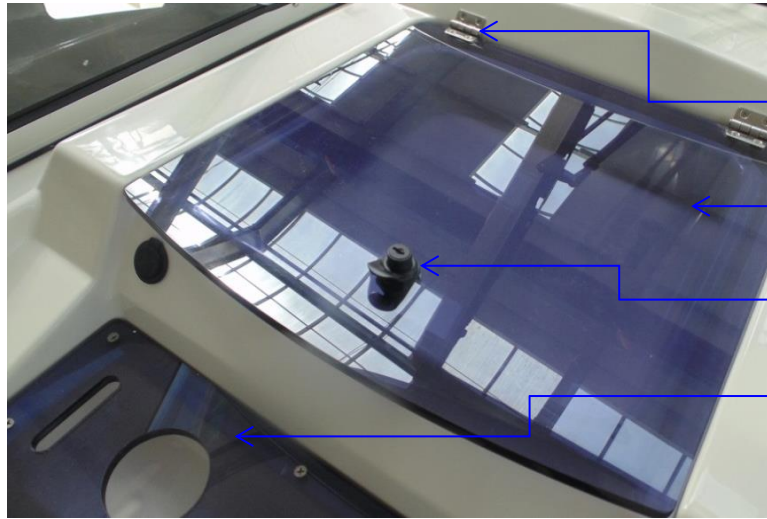

UTE 871242
HINGE 38X37 (2+2)

INT 879DEL470
D77 PORT DASH CLOSE

INT 1714041
LATCH, LOCKING W/PULL

INT 879DEL471
D77 PORT DASH CUP HLD



INT 2086306
BUMPER,CLEAR RND 12MMDIAx3.5MM



INT 2155996
O-RING, -008 EPDM

INT 2155997
O-RING, -010 EPDM

INT 2148052
SS STAND OFF 65MM

ENTERTAINMENT CENTER



INT 879DEL480
COCKPIT ENTERTAINMENT CENTER SINK LID

INT 879DEL4803
D77 ENT CENTER C-TOP NO-STOV

INT 2153738
SINK, SS OVAL 382X265X140

INT 2132430
RAIL, HAND SS 600MM X M8



INT 879DEL481
D77 GALLEY DOOR STB

INT 879DEL482
D77 GALLEY DOOR PRT
** no fridge*

INT 2155970
HINGE SS CONTINOUS 90D 45C

INT 2014920
LATCH, PUSH TO CLOSE SS



INT 875640DOUILLE
DOUILLE 9X8.5



INT 875640VIS
SCREW ALUMINIUM 9X10

INT 2026993
BELLOW CABLE, SMALL BLK

INT 1705174
EDGE TRIM FOR BOATS

INT 2063000
TAPE, VHB RP16 3/4"36Y

INT 1698881
ANGLE-3/4X3/4 W/.19 HOLE

COCKPIT TABLE/SUNLOUNGE



INT 2148877
TABLE, TEAK

INT 2149489
PEDESTAL, ADJUSTABLE GAS

INT 2155979
KNOB, GRIP FLUTEDM8X16

INT 2155978
ADAPTER, ALUM TABLE PEDES



INT 1039247
BUMPER, 3/4"DIA X 1/4"THK

INT 879DEL483
D77 CKPT TABLE FILLER

INT 2155993
RECEIVER, SS SUN LOUNGE FI

INT 2155994
PLATE, SS SUN LOUNGE FLAT

FORWARD PORT SEAT BACK



INT 879DEL472
D77 FWD PRT SEAT BACK

INT 2148047
SUPPORT, 8 DEG SEAT BACK

INT 1896799
HINGE, DRAFTED
BUTT SS3"X2



INT 2141636
CATCH, SS BALL

INT 1753746
SCREW, MACHINE # 10-24X3



INT 1040211
NUT- BBL #10-24 X3/8 TH C

INT 2127787
NUT TEE M5X8 4-PRONG SSA2



AFT LOUNGE TUB

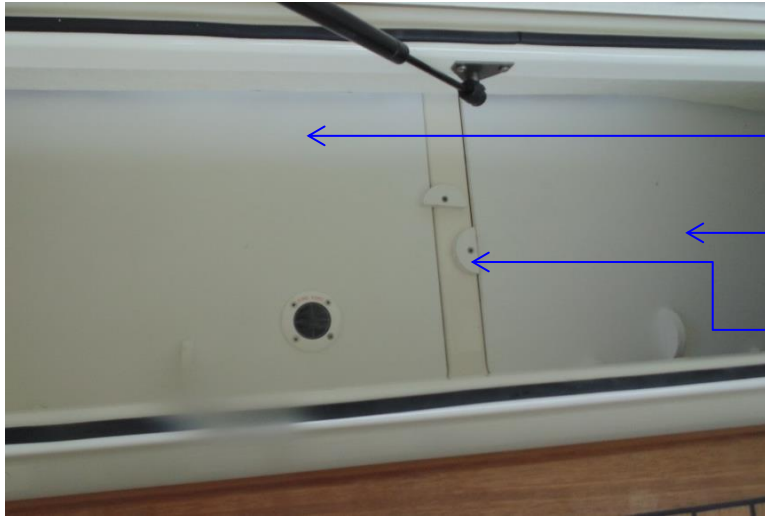

INT 879DEL464
AFT ACCESS PANEL STBD

INT 879DEL465
AFT ACCESS PANEL PORT

INT 879DEL468
STORAGE ACCESS TWIST LOCK

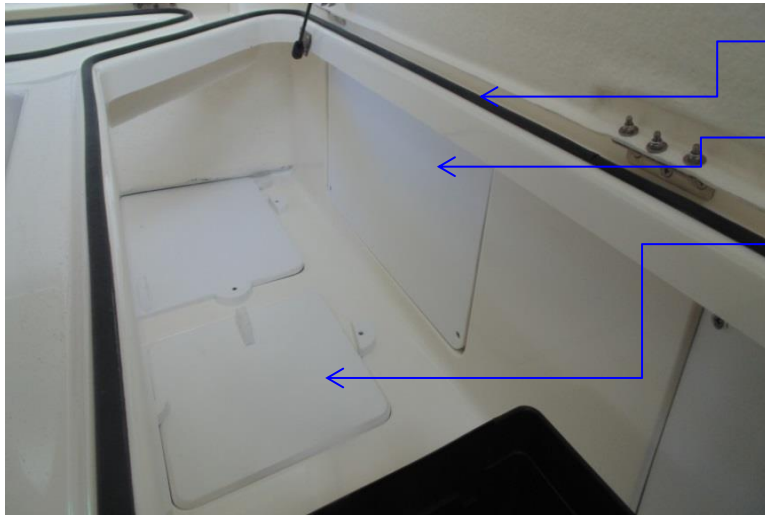

INT 1232156
TRIM-SEAL, #1333BT ST F-AD

INT 879DEL467
D77 AFT LOUNGE TUBE ACCESS

INT 879DEL466
D77 AFT LOUNGE FWD PANEL ACCESS



UTE 874692
FIREPORT

D77 GUNNEL AND TRIM

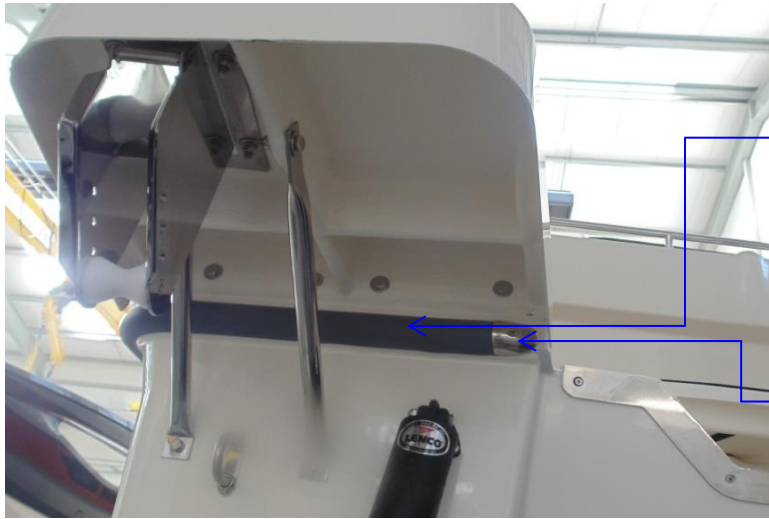

INT 2085162
GUNNEL TRIM, RADIAL PROFIL
* 18 MT is needed all around the boat

INT 2085163
GUNNEL TRIM, RADIAL TRACK D
* 18 MT is needed all around the boat

INT 2085164
GUNNEL FITTING, END CAP SS



INT 1701557
HOLDER,T-HULL THREADED N/HO

INT 1701558
FILLER,CAP T-HULLTHREADED

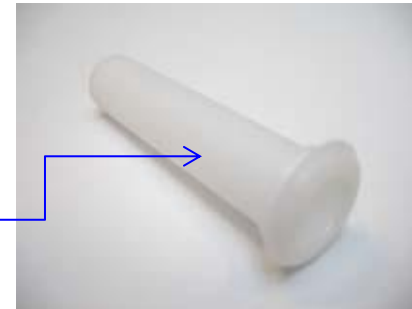

D77 FORWARD /AFT BERTH UPHOLSTERY

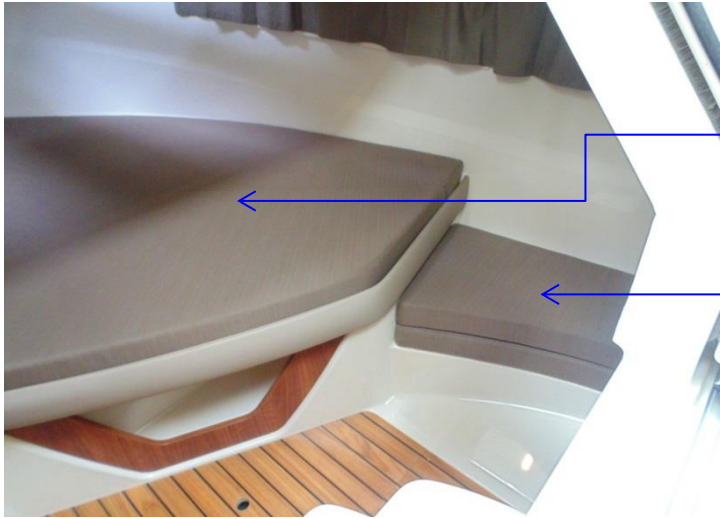

INT 2148712
MATTRESS, FWD BERTH

INT 2148880
CUSH, CABIN STB SEAT EN



INT 2148711
MATTRESS, AFT BERTH FILLER

INT 2148710
MATTRESS, AFT BERTH



INT 2153728PA
FWD BERTH STBD BLSTR

INT 2153729PA
D77 FWD BERTH CTRBLSTR

INT 2153727PA
FWD BERTH PRT FWDBLST

INT 2153730PA
D77 FWD BERTH MATRESS BOLSTER



INT 2153726PA
FWD BERTH PRT AFT BLSTR

INT 1980882
CLIP, PLASXMAS TREE SGL HEAD 1

D77 HELM BROW



INT 879DEL473
D77 HELM BROW PL

D77 CANVAS



INT 2184252
CANOPY W/
LED LIGHT EN/CD

INT 2184254
ENCLOSURE,
CONOPY EN/CD

INT 2184252LIGHT
LIGHT WITH PLASTIC
BRACK.FOR BIMINI
INCLUDED IN
INT 2184252



INT 2161858
END FITTING, GAS SPRING M6

INT 2101149
WASHER,NYLON 6MM I.DX12MM

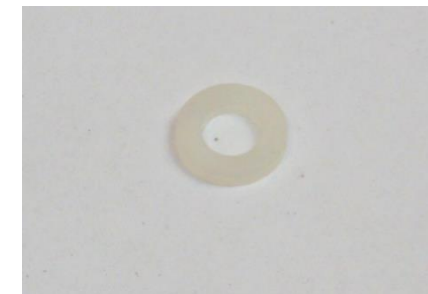

INT 2148808 CYLINDER, GAS SS TBD PSI

D77 FINAL-OTHER ASSEMBLY



INT 2086302
BAG LG FOR ACC KIT

INT 2155983
ACCESSORY KIT, SMALL 2015



INT 2148053
COVER, CKPT TABLE

D77 TAPES & LABELS

INT 2148027	GRAPHICS, STRIPE POR
INT 2148029	GRAPHICS, STRIPE STB
INT 2148030	PLATE BUILDER CE EN
INT 2120375	294KW MAX POWER PLATE
INT 2073960	SCRIPT, UTTERN W/METALLIC
INT 1811368	LABEL, DANGER CO HELM 06
INT 1811367	LABEL, DANGER CO TRANSOM 06
INT 1812911	LABEL, DANGER CO CABIN 06
INT 2016965	WARNING ROTATING PROP HELM
INT 2016954	LANYARD SWITCH LABEL
INT 2016953	WARNING PETRO FUEL LABEL
INT 2016964	WARNING ROTATING PROP LABEL
INT 2060626	EMBLEM,STEERING WHEEL CTR-1
INT 2080223	LABEL, BATT INSTLEU
INT 2148077	TAPE, MODEL DESIGNATOR D77
INT 2016947	WATERTIGHT CLOSURE LA
INT 2016949	ISO ESCAPE ROUTE LABEL

D77 DOCUMENTS

Q/S 88285508

POL.BOAT OG 19L.UTT+BMP 200

INT 2184403

DATASHEET,UTTERN BOAT SPECS



UTE 874283
COMPASS SILVA 58

UTTERN D77 OPTIONAL MATERIALS MY 2017

1. D77 HULL COLOR UPGRADE

1.1 D77 STANDARD FINISH

1.2 D77 PREMIUM UPGRADE

2. D77 COCKPIT COMFORT PACK

2.1 805CR NO COCKPIT COMF PACK

2.2 805CR COCKPIT COMF PACK

3. D77 CABIN COMFORT PACK

3.1 D77 DIESEL HEATER

3.2 805CR CURTAINS

4. D77 ELECTRONIC PACK

4.1 805CR GPS

4.2 805CR STEREO

5. D77 VESSEL VIEW

6. D77 PREMIUM EDITION

6.1 D77 TRANSOM SHOWER

6.2 805CR REFRIGERATOR

6.3 805CR COCKPIT STOVE /HEATER

6.4 805CR WATER SKI POLE

6.5 805CR DIESEL HEATER

6.6 805CR CURTAINS

6.7 805CR GPS

6.8 D77 STEREO

7. D77 MOORING COVER

8. D77 COCKPIT FLOORING

8.1 D77 LAM TEAK FLOOR NO OPTION

8.3 D77 LAM TEAK FLOOR W/BOW WINSLASS

8.2 D77 LAM TEAK FLOOR W/EXT PL

8.4 D77 LAM TEAK FLR W/BOW WINDLASS/SWIM PLATF

9. D77 GREY WATER SYSTEM

9.1 D77 NO GREY WATER

9.2 D77 GREY WATER SYSTEM

10. D77 SHORE POWER

11. D77 ELECTRIC WINDLASS

11.1 D77 NO WINDLASS

11.3 D77 AFT WINDLASS

11.2 D77 FWD WINDLASS

11.4 D77 FWD AND AFT WINDLASS

12. D77 SWIM PLATFORM EXTENSION

12.1 805CR NO SWIM PLATFORM EXT

12.3 D77 SELECT W/AFT WNDLASS

12.2 805CR SWIM PLATFORM EXTENSION

13. D77 TRIM TABS

14. D77 BOW THRUSTER

15. D77 ENGINE OPTIONS

15.1 D77 BLNK L4 VERADO SC HYDRAULIC STEERING

15.3 D77 VERADO 250 SC HYDRAULIC STEERING

15.5 D77 VERADO 350 SC HYDRAULIC STEERING

15.7 D77 TWIN VERADO 200 HYDRAULIC

15.9 D77 TWIN BLNK 150 4STROKE SC HYDRAULIC

15.2 D77 VERADO 200 SC HYDRAULIC STEERING

15.4 D77 VERADO 300 SC HYDRAULIC STEERING

15.6 D77 TWIN 150 4STROKE HYDRAULIC

15.8 D77 TWIN L4 BLNK VERADO SC

15.10 D77 BLNK L6 VERADO SC HYDRAULIC STEERING

1. D77 HULL COLOR UPGRADE

1.1 D77 STANDARD FINISH



HULL **INT 875902031**
GELCOAT WHITE (ARCTIC)
Reichold color number 30794H

DECK **INT 875902039**
GREY GELCOAT
Reichold color number SVG80369S



INT 2161869PA
HELM SEAT, UTT CARBON SUN

1.1.1 D77 COCKPIT UPHOLSTERY (FULL OPTION)

→ D77CKPTUPHPA

SPARE PARTS FOR HOLDERS OF D77 CKPT UPH



INT 2148759
B/REST, AFT CKPT BENCH SEAT

INT 2148717
CUSH, AFT CKPT BENCH SEAT

INT 2148761
B/REST, AFT CKPT BENCH SEAT PR

INT 2148715
CUSH, AFT CKPT BENCH SEAT PRT

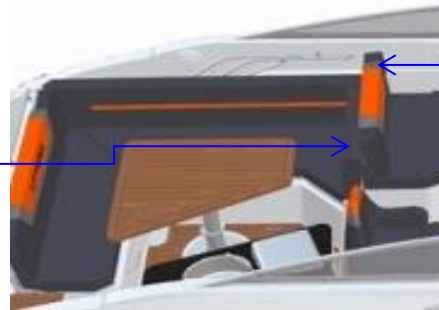

INT 2148762
B/REST, FWD CKPT
BENCH SEAT

INT 2148716
CUSH FWD CKPT BENCH SEAT

INT 2148760
B/REST, AFT CKPT
BENCH SEAT FW

1.1.2 D77 SUNLOUNGE UPHOLSTERY

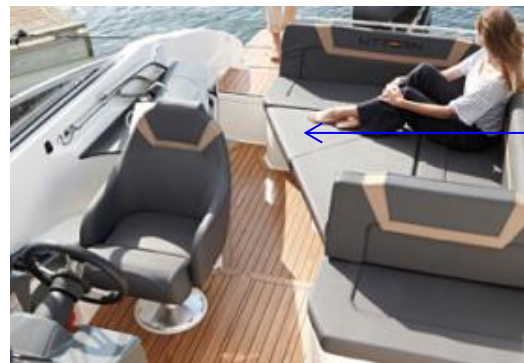

INT 2148764
CUSH, SUNLOUNGE

1.2 D77 PREMIUM UPGRADE



HULL **INT 875902031**
GELCOAT WHITE (ARCTIC)
Reichold color number 30794H

DECK **INT 875902040**
ORANGE GELCOAT
Reichold color number SVG20860S



INT 2161870PA
HELM SEAT, UTT OTONO METEO

1.2.1 D77 COCKPIT UPGR UPHOLSTERY (FULL OPTION)

—————> INT D77CKPTUPHUPPA

SPARE PARTS FOR HOLDERS OF D77 CKPT UPGRD UPH

INT 2148060
B/REST, UPG AFT CKPT
BENCH ST PRT

INT 2148885
B/REST, UPG AFT CKPT
BENCH SEA

INT 2148884
CUSH, UPG AFT CKPT
BENCH SEAT



INT 2148887
B/REST, UPG FWD CKPT
BENCH SEA

INT 2148883
CUSH, UPG FWD CKPT
BENCH SEAT

INT 2148886
B/REST, UPG AFT CKPT
BENCH ST FWD

INT 2148882
CUSH, UPG AFT CKPT
BENCH SEAT PRT

1.2.2 D77 SUNLOUNGE UPHOLSTERY



INT 2148888
CUSH, UPG SUNLOUNGE

2. D77 COCKPIT COMFORT PACK

2.1 D77 NO COCKPIT COMFORT PACK

SPARE PARTS FOR HOLDERS OF NO COCKPIT COMFORT PACK OPTION



INT 879DEL482 * NO REFRIDGERATOR
D77/805 GALLEY DOOR PRT

INT 2155970
HINGE SS CONTINOUS 90D 45C

INT 2014920
LATCH, PUSH TO CLOSE SS

INT 2047542
COOLER 18QT 12V KOOLATRON



INT 1702532
CLEAT, SEAT 4" BLK



INT 875640DOUILLE
DOUILLE 9X8.5



INT 875640VIS
SCREW ALUMINIUM 9X10



UTE 870602
TANKSTRAP 1.5 M

UTE 873748

SOCKET 12V ROUND FLUSH MOU

2.2 D77 COCKPIT COMFORT PACK

2.2.1 D77 TRANSOM SHOWER

SPARE PARTS FOR HOLDERS OF TRANSOM SHOWER OPTION



INT 2112327
SHOWER, TRANSOM TWIST CO



INT 1693278
COUPLING, EQUAL STRGHT 1



INT 1693276
TEE, STEM 15MM

2.2.2 D77 REFRIGERATOR (FULL OPTION)

—————> INT D77FRIDGEPA

SPARE PARTS FOR HOLDERS OF REFRIDGERATOR OPTION



INT 2225514
REFER VITRIFRIGO C51I AIRLOCK BLAC

INT 2225515
FRAME VITRIFRIGO FRAME VITRIFRIGO

2.2.3 D77 COCKPIT STOVE / HEATER

SPARE PARTS FOR HOLDERS OF COCKPIT STOVE / HEATER OPTION



UTE 874591
HEAT BLOWER LID WALLAS 80

UTE 874590
STOVE WALLAS 800

UTE 874627
DRAINSLEEVE WALLAS 800

INT 2148063
KIT, EXH HOSE
COOKER EN

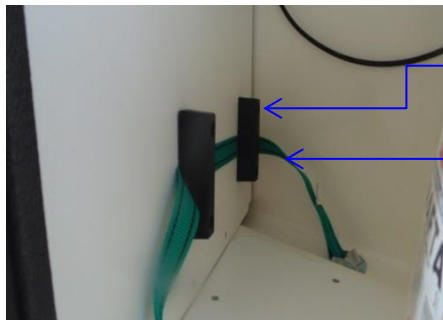

INT 1702532
CLEAT,SEAT 4" BLK

UTE 870602
TANKSTRAP 1.5 M

UTE 871946
FEULTANK 5 L WALLAS

INT 879DEL4804
D77 ENT CENTER C-TOP W/STOVE



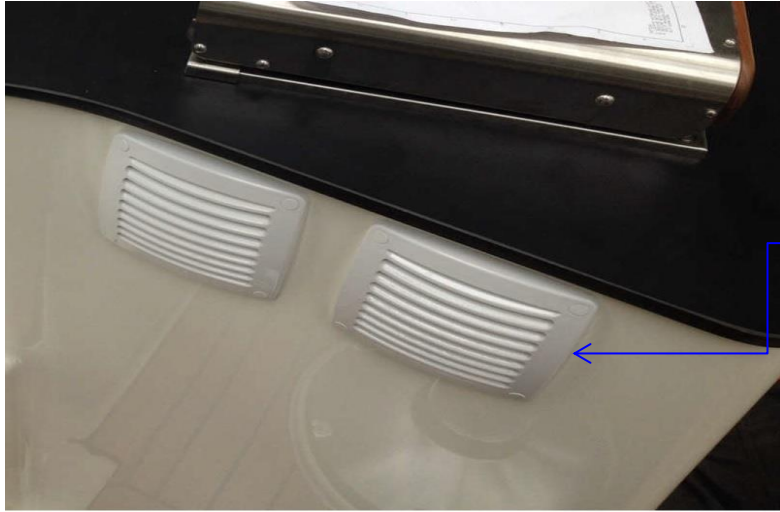

INT 875860
SET IN VENTILATION WHITE



INT D77STOVESHELF
D77 STOVE SHELF NEW VERS. RETROFIT

2.2.4 D77 WATER SKI POLE (FULL OPTION)

—————> INT D77SKIMASTPA

SPARE PARTS FOR HOLDERS OF WATER SKI POLE OPTION



INT 2148889
SKI TOW PYLON

INT 2148891
DECK PLATE, SKI TOW



INT 2148890
BASE, SS SKI TOW PYLON

INT 2026923
DECK PLATE, SCREW IN 188MM

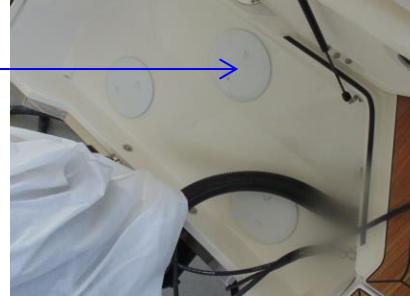

INT 879DEL506
D77/805 CANVAS STORAGE HLDER (SET)

INT 1701595 *
BUMPER GLASS DOOR 12948
* included in INT 879DEL506



INT 2241513
KEY,SKI TOW PLATE

INT 2026967 LABEL,SKI POLE WARNING

INT 2193476 LABEL,WARNING SKI PYLON 300KG

3. D77 CABIN COMFORT PACK

3.1 D77 DIESEL HEATER

SPARE PARTS FOR HOLDERS OF DIESEL HEATER OPTION



INT 2150724
HEATER, 3KW DIESEL WALLAS

INT 2150700
KIT, HEATER HOSE EN

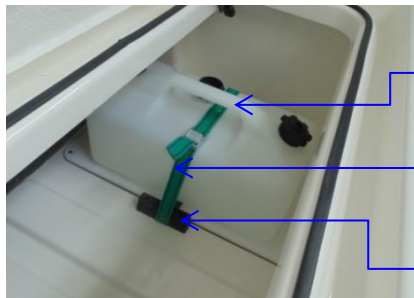

INT 2150704
TANK, FUEL 10L

UTE 870602
TANKSTRAP 1.5 M

INT 1702532
CLEAT, SEAT 4" BLK

INT 2150715
ADAPTER, 60/75MM WALLAS



INT 2150708
THRU HULL, EXHAUST COAXIAL



INT 2150710
GRILL, AIR DUCT INTAKE W



INT 2150722
VENT, AIR 60MM CLOSABLE



INT 2150713
VENT, AIR 75MM WHITE WA

INT 2153740
PICK UP, FUEL FEED W/MAG

3.2 D77 CURTAINS (FULL OPTION)

—————> **INT D77CURTAINSPA**

SPARE PARTS FOR HOLDERS OF CURTAINS OPTION



INT 2148765
CURTAIN, FWD BERTH PRT



INT 2148769
CURTAIN, FWD BERTH PRIVAC



INT 2148767
CURTAIN, FWD BERTH STB



INT 2148778
CURTAIN, HEAD

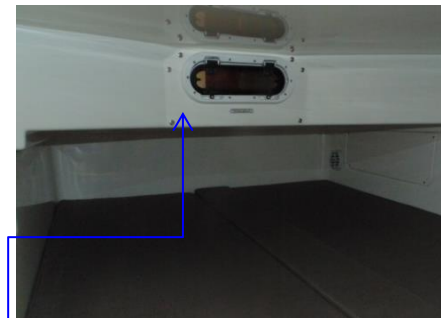

INT 2148777
CURTAIN, AFT BERTH PRIVACY AFT



INT 2148774
CURTAIN, AFT BERTH PRIVAC FWD

INT 2148772
CURTAIN, FWD BERTH SKYLIG STB

INT 2148770
CURTAIN, FWD BERTH SKYLIG PRT





INT 2106831
TRACK, PLASTIC CURTAIN WHTITE 12'



INT 2118419
BUTTON, ELASTIC CABLE WHITE

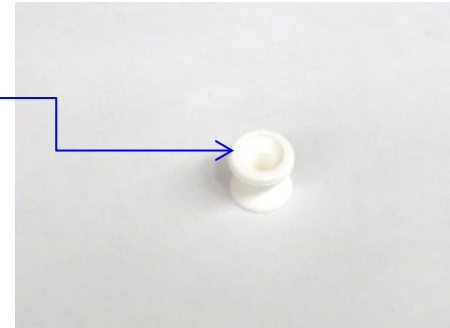

4. D77 ELECTRONIC PACK

→ **INT D77ELECTPKPA**

4.1 D77 GPS (FULL OPTION)

→ **INT D77GPSPA**

SPARE PARTS FOR HOLDERS OF GPS OPTION



INT 2155999
GPS COMBO, SIMRAD NSS9

INT 2160396
CABLE,NMEA 0183/VIDEO SIM

INT 2165337
CABLE,EXT 3M SIMRAD XT-12



INT 2160398
BAG, SIMRAD OWNERS PACK

INT 875335001INOX
S.S MIDGET VENT

INT 2160397
TRANSDUCER,HDI SKIMMER TR

INT 2196000
C-MAP

INT 217001
CABLE CLAMP6MM NYLON WHITE

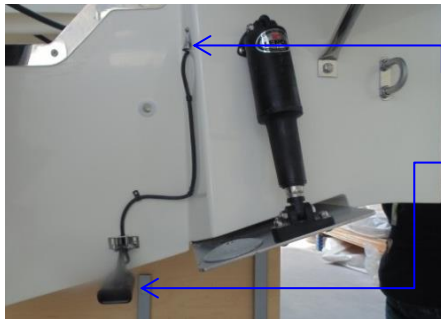



INT 2160375*
CABLE, POWER N2K MICRO-C



INT 2160379*
CABLE, N2KEXT-6'
MICRO-C



INT 2160377*
TERMINATOR N2K TR-120 KIT



Q/S 892453A01*
+CABLE ASY-ADAPT
FEMALE/FEMALE



INT 2160376*
BACKBONE 4-WAY N2K



Q/S 878492T14*
+JUNCTION BOX
4-WAY



Q/S 1128345*
SPACER-.26 X .50 X .45

Q/S 8M0105243*
CAN P GATEWAY-MULTI

Q/S 859318T2*
WEATHER CAP-JUNCTION BOX

Q/S 898160T01*
HARNESS-INSTRUMENT EXTENS

* parts available from HIN BE-UTBEN005J617

4.2 D77 STEREO (FULL OPTION)

→ INT D77STEREOPA

SPARE PARTS FOR HOLDERS OF STEREO OPTION



INT 2120450
STEREO, FUSION 205 AM/FM/

INT 2150657
PANEL, SPEAKER SELECT EN/

INT 2138218
ANTENNA, SOFTWIRE AM FM 7

INT 2136763
MODULE, BLUE TOOTH



INT 2150462
CABLE, USB STEREO



INT 2211415
SPEAKER, WHT FUSION EL 602 PAIR



5. D77 VESSEL VIEW (FULL OPTION)

→ **INT D77VESSELVIEWPA ***
*** option available only to HIN BE-UTBEN004J617**

SPARE PARTS FOR HOLDERS OF VESSEL VIEW OPTION



Q/S 8M0074096
+V-VIEW 4 TOP LEVEL KIT



Q/S 878492T14
JUNCTION BOX 4-WAY

Q/S 892453A01
+CABLE ASY-ADAPT
FEMALE/FEMALE

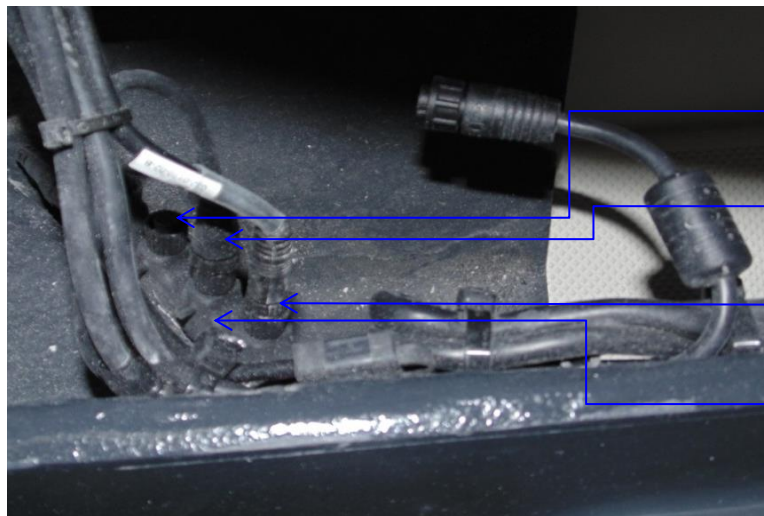

INT 2160377
TERMINATOR N2K TR-120 KIT

INT 2160375
CABLE, POWER N2K MICRO-C

INT 2160379
CABLE, N2KEXT-6' MICRO-C

INT 2160376
BACKBONE 4-WAY N2K

6. D77 PREMIUM EDITION

6.1 D77 TRANSOM SHOWER

TO SEE SPARE PARTS GO TO PAGE 65

6.2 D77 REFRIGERATOR (FULL OPTION)

TO SEE SPARE PARTS GO TO PAGE 66

—————> INT D77FRIDGEPA

6.3 D77 COCKPIT STOVE / HEATER

TO SEE SPARE PARTS GO TO PAGE 67 - 68

6.4 D77 WATER SKI POLE (FULL OPTION)

TO SEE SPARE PARTS GO TO PAGE 69

—————> INT D77SKIMASTPA

6.5 D77 DIESEL HEATER

TO SEE SPARE PARTS GO TO PAGE 70-71

6.6 D77 CURTAINS (FULL OPTION)

TO SEE SPARE PARTS GO TO PAGE 72-73

—————> INT D77CURTAINSPA

6.7 D77 GPS (FULL OPTION)

TO SEE SPARE PARTS GO TO PAGE 74

—————> INT D77GPSPA

6.8 D77 STEREO (FULL OPTION)

TO SEE SPARE PARTS GO TO PAGE 75

—————> INT D77STEREOPA

7. D77 MOORING COVER

(FULL OPTION)

→ [D77MOORCVRPA](#)



SPARE PART FOR CANVAS MOORING COVER

INT 3000109

M C SUP LEG LONG QS 645 D/T 62

8. D77 COCKPIT FLOORING

8.1 D77 LAM TEAK FLOOR NO OPTION (FULL OPTION) → INT D77LAMFLRPA

SPARE PARTS FOR HOLDERS OF TEAK FLOOR NO OPTION

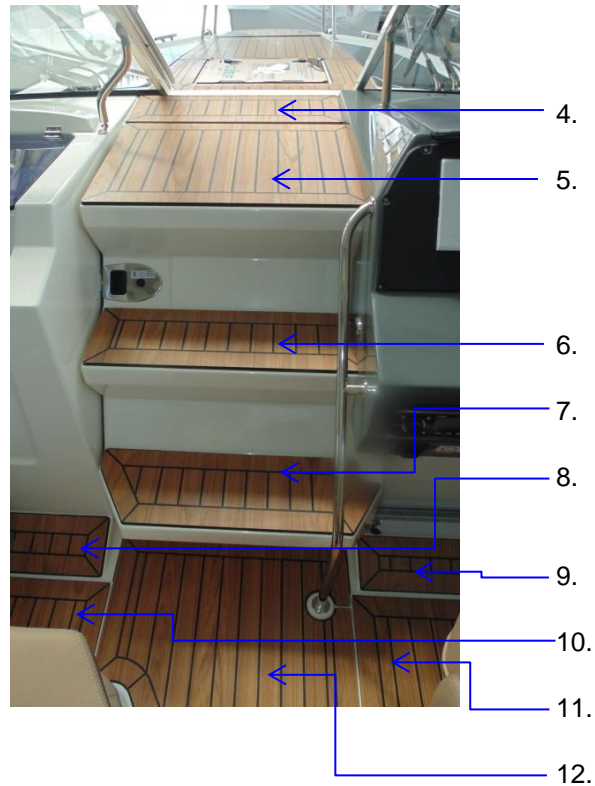
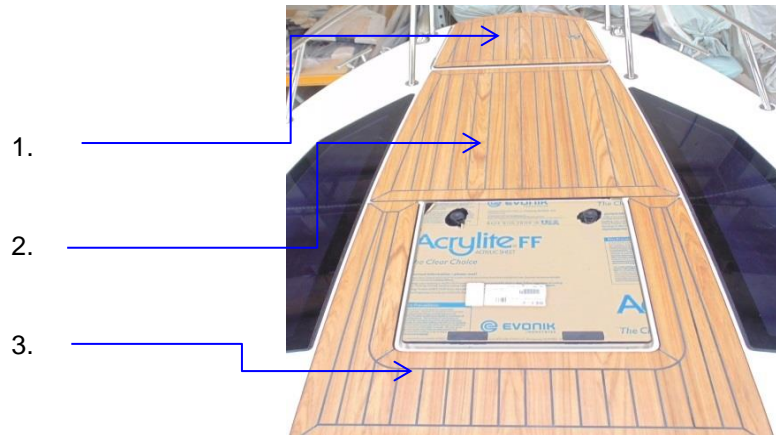

- | | | |
|----|-------------|-----------------------------|
| 1 | INT 2148805 | LAM TEAK, BOW HATCH NO ROL |
| 2 | INT 2148804 | LAM TEAK, BOW WALK THRU FW |
| 3 | INT 2148803 | LAM TEAK, BOW WALK THRU AFT |
| 4 | INT 2148802 | LAM TEAK, DASH |
| 5 | INT 2148801 | LAM TEAK, TOP STEP |
| 6 | INT 2148800 | LAM TEAK, MID STEP |
| 7 | INT 2148796 | LAM TEAK, BOTTOM STEP |
| 8 | INT 2148798 | LAM TEAK, PORT FOOTREST |
| 9 | INT 2148799 | LAM TEAK, STBD FOOTREST |
| 10 | INT 2148785 | LAM TEAK, FWD COCKPIT PORT |
| 11 | INT 2148794 | LAM TEAK, FWD COCKPIT STBD |
| 12 | INT 2148782 | LAM TEAK, CENTER FWD CKPT |

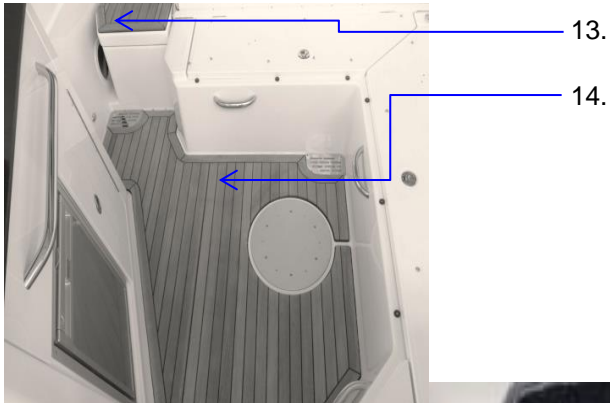

- 13 INT 2195989 LAM TEAK, TRANSOM WALK THR
- 14 INT 2148792 LAM TEAK, AFT COCKPIT
- 15 INT 2148786 LAM TEAK, MOTORWELL BRIDGE
- 16 INT 2148784 LAM TEAK, PORT SWIM PLATFORM
- 17 INT 2148788 LAM TEAK, STBD SWIM PLATFORM

- 18 INT 2148817 LAM TEAK,PORT SWIM PLATF FILLER
- 19 INT 2148066 LAM TEAK,STBD SWIM PLATF FILLER
- 20 INT 2148783 LAM TEAK, PORT ACCESS HATC
- 21 INT 2152363 LAM TEAK, LADDER COVER

8.2 D77 LAM TEAK FLOOR W/EXT PL (FULL OPTION)

→ **INT D77LAMFLREXTPA**

SPARE PARTS FOR HOLDERS OF LAM TEAK FLOOR W/EXT PL OPTION

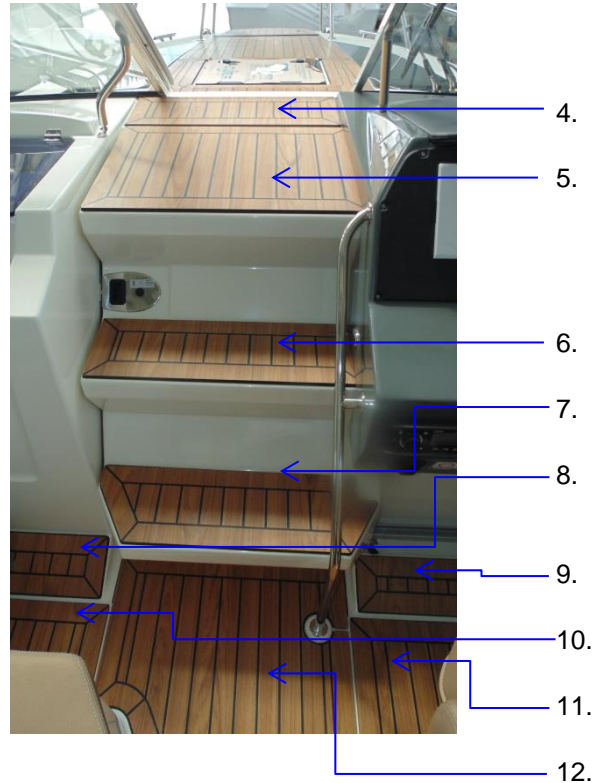
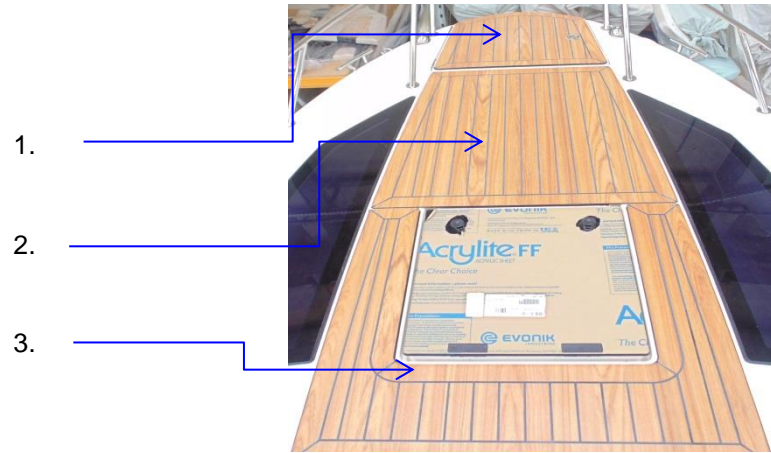

- 1 INT 2148805 LAM TEAK, BOW HATCH NO ROL
- 2 INT 2148804 LAM TEAK, BOW WALK THRU FW
- 3 INT 2148803 LAM TEAK, BOW WALK THRU AFT
- 4 INT 2148802 LAM TEAK, DASH
- 5 INT 2148801 LAM TEAK, TOP STEP
- 6 INT 2148800 LAM TEAK, MID STEP
- 7 INT 2148796 LAM TEAK, BOTTOM STEP
- 8 INT 2148798 LAM TEAK, PORT FOOTREST
- 9 INT 2148799 LAM TEAK, STBD FOOTREST
- 10 INT 2148785 LAM TEAK, FWD COCKPIT PORT
- 11 INT 2148794 LAM TEAK, FWD COCKPIT STBD
- 12 INT 2148782 LAM TEAK, CENTER FWD CKPT

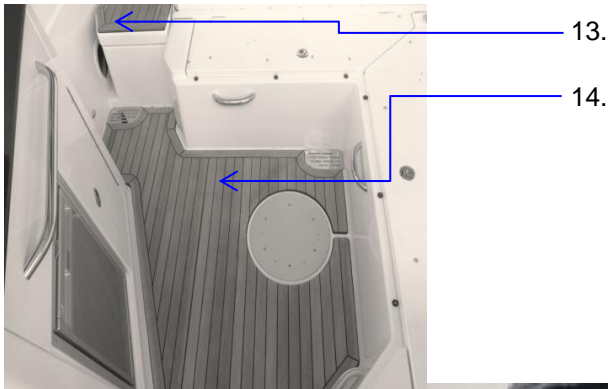

- 13 INT 2195989 LAM TEAK, TRANSOM WALK THR
- 14 INT 2148792 LAM TEAK, AFT COCKPIT
- 15 INT 2148786 LAM TEAK, MOTORWELL BRIDGE
- 16 INT 2148784 LAM TEAK, PORT SWIM PLATFORM
- 17 INT 2148788 LAM TEAK, STBD SWIM PLATFORM

- 18 INT 2148817 LAM TEAK, PORT SWIM PLATF FILLER
- 19 INT 2148066 LAM TEAK, STBD SWIM PLATF FILLER
- 20 INT 2148783 LAM TEAK, PORT ACCESS HATC
- 21 INT 2152363 LAM TEAK, LADDER COVER
- 22 INT 2148780 LAM TEAK, PORT SWIM STEP
- 23 INT 2148781 LAM TEAK, STBD SWIM STEP



22 INT 2148780 LAM TEAK, PORT SWIM STEP



23 INT 2148781 LAM TEAK, STBD SWIM STEP

8.3 D77 LAM TEAK FLOOR W/BOW WN (FULL OPTION)

—————> **INT D77LAMFLRWNDLSPA**

SPARE PARTS FOR HOLDERS OF LAM TEAK FLOOR W/BOW WN OPTION

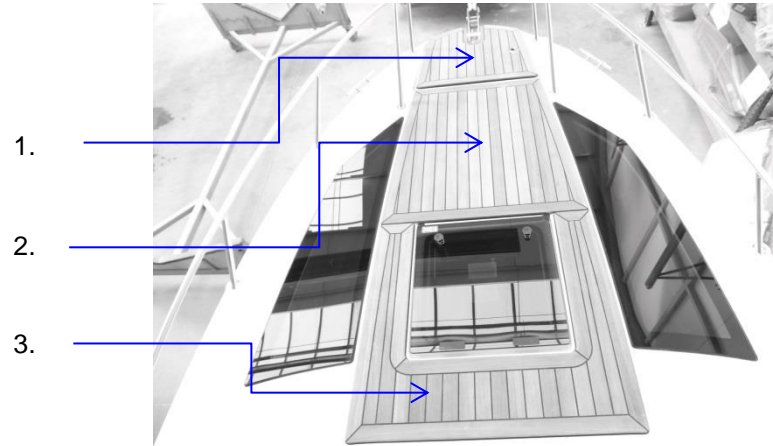

- | | | |
|---|--------------------|-----------------------------|
| 1 | INT 2154607 | LAM TEAK, BOW HATCH W/ROLL |
| 2 | INT 2148804 | LAM TEAK, BOW WALK THRU FW |
| 3 | INT 2148803 | LAM TEAK, BOW WALK THRU AFT |

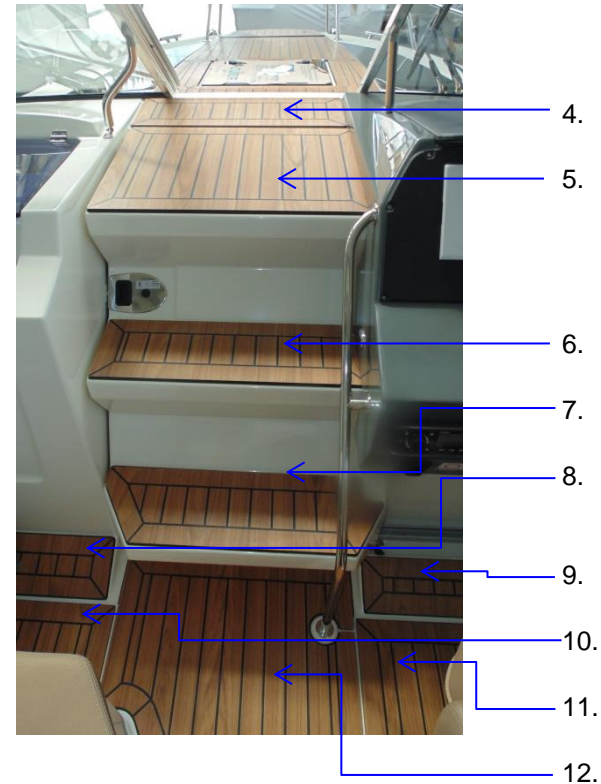

- | | | |
|----|--------------------|----------------------------|
| 4 | INT 2148802 | LAM TEAK, DASH |
| 5 | INT 2148801 | LAM TEAK, TOP STEP |
| 6 | INT 2148800 | LAM TEAK, MID STEP |
| 7 | INT 2148796 | LAM TEAK, BOTTOM STEP |
| 8 | INT 2148798 | LAM TEAK, PORT FOOTREST |
| 9 | INT 2148799 | LAM TEAK, STBD FOOTREST |
| 10 | INT 2148785 | LAM TEAK, FWD COCKPIT PORT |
| 11 | INT 2148794 | LAM TEAK, FWD COCKPIT STBD |
| 12 | INT 2148782 | LAM TEAK, CENTER FWD CKPT |

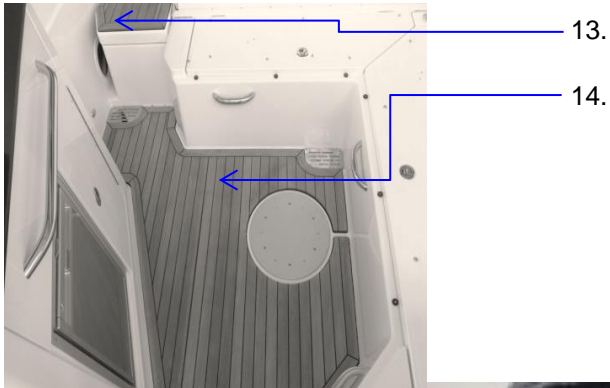

- 13 INT 2195989 LAM TEAK, TRANSOM WALK THR
- 14 INT 2148792 LAM TEAK, AFT COCKPIT
- 15 INT 2148786 LAM TEAK, MOTORWELL BRIDGE
- 16 INT 2148784 LAM TEAK, PORT SWIM PLATFORM
- 17 INT 2148788 LAM TEAK, STBD SWIM PLATFORM

- 18 INT 2148817 LAM TEAK, PORT SWIM PLATF FILLER
- 19 INT 2148066 LAM TEAK, STBD SWIM PLATF FILLER
- 20 INT 2148783 LAM TEAK, PORT ACCESS HATC
- 21 INT 2152363 LAM TEAK, LADDER COVER

8.4 D77 LAM TK FLR W/WNDLS/SWIM (FULL OPTION)

—————> **INT D77LAMFLWNDLEXT**

SPARE PARTS FOR HOLDERS OF LAM TEAK FLOOR W/WNDLS S/SWIM OPTION

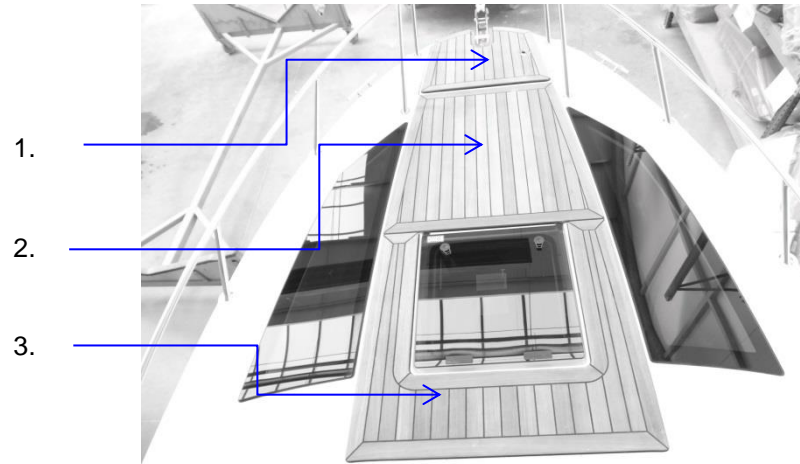

- 1.
- 2.
- 3.

- 1 INT 2154607 LAM TEAK, BOW HATCH W/ROLL
- 2 INT 2148804 LAM TEAK, BOW WALK THRU FW
- 3 INT 2148803 LAM TEAK, BOW WALK THRU AFT
- 4 INT 2148802 LAM TEAK, DASH
- 5 INT 2148801 LAM TEAK, TOP STEP
- 6 INT 2148800 LAM TEAK, MID STEP
- 7 INT 2148796 LAM TEAK, BOTTOM STEP
- 8 INT 2148798 LAM TEAK, PORT FOOTREST
- 9 INT 2148799 LAM TEAK, STBD FOOTREST
- 10 INT 2148785 LAM TEAK, FWD COCKPIT PORT
- 11 INT 2148794 LAM TEAK, FWD COCKPIT STBD
- 12 INT 2148782 LAM TEAK, CENTER FWD CKPT

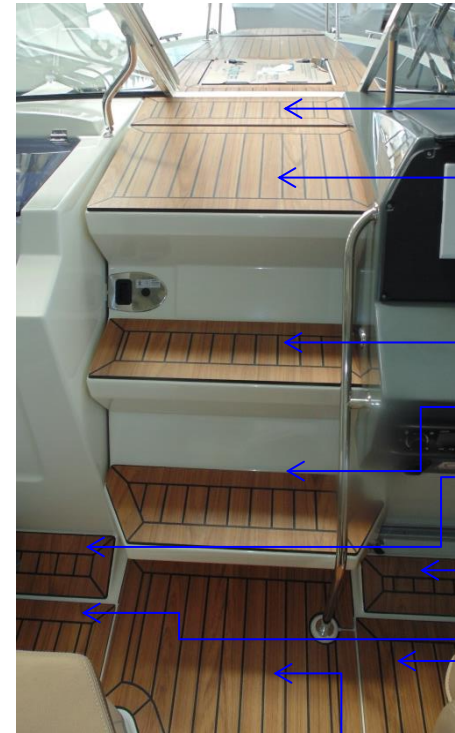

- 4.
- 5.
- 6.
- 7.
- 8.
- 9.
- 10.
- 11.
- 12.

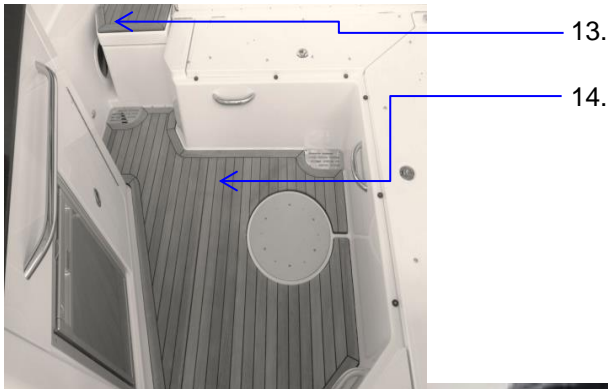

- 13 INT 2195989 LAM TEAK, TRANSOM WALK THR
- 14 INT 2148792 LAM TEAK, AFT COCKPIT
- 15 INT 2148786 LAM TEAK, MOTORWELL BRIDGE
- 16 INT 2148784 LAM TEAK, PORT SWIM PLATFORM
- 17 INT 2148788 LAM TEAK, STBD SWIM PLATFORM

- 18 INT 2148817 LAM TEAK, PORT SWIM PLATF FILLER
- 19 INT 2148066 LAM TEAK, STBD SWIM PLATF FILLER
- 20 INT 2148783 LAM TEAK, PORT ACCESS HATC
- 21 INT 2152363 LAM TEAK, LADDER COVER
- 22 INT 2148780 LAM TEAK, PORT SWIM STEP
- 23 INT 2148781 LAM TEAK, STBD SWIM STEP



22 INT 2148780 LAM TEAK, PORT SWIM STEP



23 INT 2148781 LAM TEAK, STBD SWIM STEP

9. D77 GREY WATER SYSTEM

9.1 D77 NO GREYWATER



INT 2081404
DRAIN,P-TRAP 1-1/4"W/TAIL

INT 2081427
DRAIN STRAIGHT PLASTIC 53M



INT 1733662
THRU-HULL 1.25 BARBED SS F

INT 2153739
STRAINER, 1-1/4" STRAIGHT



INT 2081426
HOSE, 1-1/4" ID HD CLEAR



INT 2111292
CLAMP HOSE NR16 SS

INT 830968
COVER, CLAMP END 1/2" X .045"

9.2 D77 GREY WATER SYSTEM

SPARE PARTS FOR HOLDERS OF GREY WATER SYSTEM OPTION

INT 1694239
HOSE- SANI 1 ID WHT

INT 2111292
CLAMP HOSE NR16 SS

INT 1841111
PUMP, SHOWER SUMP12V 500GP



INT 1692922
3/4" ID CORR PVC WATER HOS

INT 263954
HOSE CLAMP #10



INT 2147516
TANK, GRAYWATER 80L BOX P

INT 2037135
THRU-HULL,PLAS SSCAP 3/4"S

UTE 877020
HOSE WASTE 19MM



INT 1971021
DECK PLATE,WASTE CHR STRAI

INT 846899
HOSE, SANI 1.5" PREMIUM R



INT 2118659
DRAIN,SINK/SHOWER 1.5"X25M

INT 2081404
DRAIN,P-TRAP 1-1/4"W/TAIL PC,BEZEL



INT 2081404
DRAIN,P-TRAP 1-1/4"W/TAIL



INT 2153739
STRAINER, 1-1/4" STRAIGHT



INT 2081426
HOSE, 1-1/4" ID HD CLEAR



INT 123489
HOSE CLAMP #24

INT 2111292
CLAMP HOSE NR16 SS

INT 830968
COVER, CLAMP END 1/2"X.045"

INT 2148071 HARNESS, GREY WATER EN/DC

10. D77 SHORE POWER OPTION

SPARE PARTS FOR HOLDERS OF SHORE POWER OPTION



INT 1701610
SHORE POWER, INLET 230



INT 2148035
PANEL, AC DISTRIBUTION EN/



INT 2066273
30 AMP PRONAUTIC 1230P CHA



INT 2127753 FRAME, INTEGRO FLOW PRL WH

INT 2127755 OUTLET, SCHUKO INTEGRO FLO

INT 2127754 BOX, INTEGRO FLOW BACK COV

INT 2141652 CABLE,DOCKSIDE 16A 230V 15

INT 2014745 GALVANIC ISOLATOR FAILSAFE 30A

INT 2148034 HARNESS, SHORE POWER EN/CD

11. D77 ELECTRIC WINDLASS OPTION

11.1 D77 NO WINDLASS



INT 2118444
CLEAT, 8"X2" HERESHOFF 316SS

11.2 D77 FWD WINDLASS (FULL OPTION)

—————> **INT D77FWINDLSPA**

SPARE PARTS FOR HOLDERS OF FWD WINDLASS OPTION

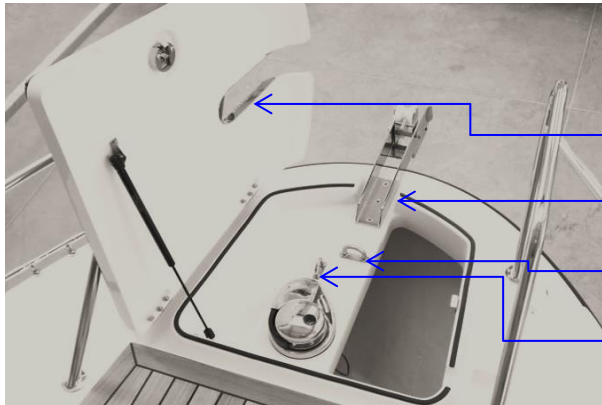

INT 2118200

INT 2148085

INT 2089727

INT 2088144

INT 875904002GM

BRUNSWICK RECOMMENDATION:
6mm chain DIN766 or ISO standard,
1/2" three strand polyester rope.
WINDLASS, DP2 500W W/HELM

SS TRIM/CHAFE PLATE

ROLLER, ANCHOR SSPIVOT

EYE,BOW 316SS 1/2"X2 5/

S.S STERN EYE BIG MODEL



INT 2204066

LANYARD,ANCHOR SAFETY 300MM



INT 1794348

HOOK, SNAP 1/4"X21/2" SS



Q/S 79695T

+INSULATOR BOOT-BLACK (PACKAGD)

INT 2134845

BREAKER, 80 AMP C SERIES TO



INT 2148039

HARNESS, WINDLASS BOW EN/C

11.3 D77 AFT WINDLASS (FULL OPTION)

→ **INT D77AWINDLSPA**

*** AVAILABLE ONLY FOR HOLDERS OF SWIM PLATFORM OPTION**

SPARE PARTS FOR HOLDERS OF AFT WINDLASS OPTION

BRUNSWICK RECOMMENDATION:

ROPE ONLY, 12/14/16mm diameter leaded core



INT 2106461
ROLLER, SWIM PLATFORM SS

INT 2106828
PLATE,SS BACKING SWIM PLAT

INT 2161862
TUBE,STERN WNDLS ROLLER SU

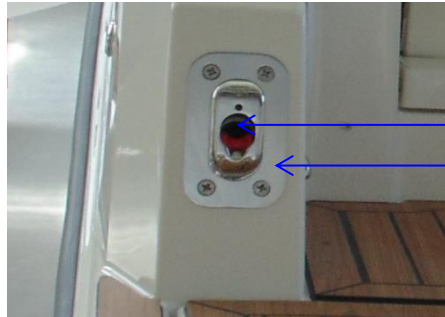

INT 2204061
WINDLASS,BALDER 612 12V

INT 2148853
PLATE, SS BACKINGAUTO STOP

INT 2148055
ROLLER, AFT WINDLASS



Q/S 79695T
+INSULATOR BOOT-BLACK(PACK

INT 2026923
DECK PLATE, SCREW IN 188MM



INT 2106463
ROPE, 12MM LEADED CORE



INT 2132429
ANCHOR DEADEND W15MM HOL

INT 2148040
HARNESS, WINDLASS STERN EN

INT 2134845
BREAKER, 80 AMP C SERIES TO

11.4 D77 FWD AND AFT WINDLASS

SPARE PARTS FOR HOLDERS OF AFT AND FWD WINDLASS OPTION



INT 2106461
ROLLER, SWIM PLATFORM SS

INT 2106828
PLATE,SS BACKING SWIM PLAT

INT 2161862
TUBE,STERN WNDLS ROLLER SU

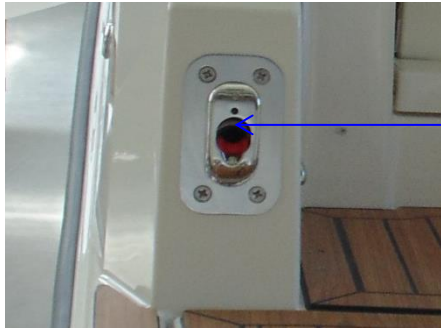

INT 2204061
WINDLASS,BALDER 612 12V

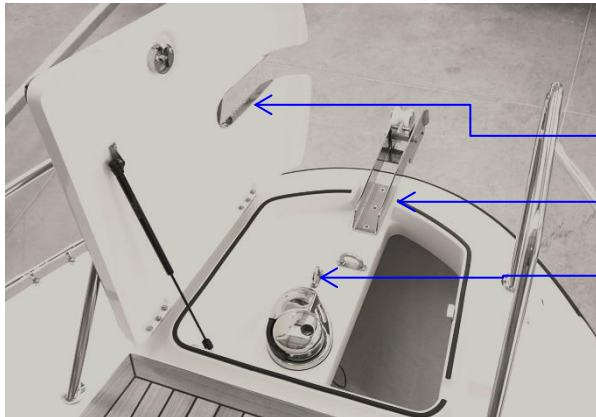

INT 2118200 WINDLASS, DP2 500W W/HELM

INT 2148085 SS TRIM/CHAFE PLATE

INT 2118351 ROLLER, BOW SS PIVOTING

INT 875904002GM S.S STERN EYE BIG MODEL



INT 2118444
CLEAT,8"X2"HERESHOFF 316SS



INT 1794348
HOOK, SNAP 1/4"X2 1/2" SS



Q/S 79695T
+INSULATOR BOOT-BLACK (PACKAGD)



INT 2204066
LANYARD,ANCHOR SAFETY 300MM



INT 2106463
ROPE, 12MM LEADED CORE

INT 2148040 HARNESS, WINDLASS STERN EN

INT 2148039 HARNESS, WINDLASS BOW EN/C

INT 2118444 CLEAT,8"X2"HERESHOFF 316SS

INT 2134845 BREAKER, 80 AMP C SERIES TO

12. D77 SWIM PLATFORM EXTENSION

12.1 D77 NO SWIM PLATFORM EXTENSION

INT 2195987

LADDER,3-STEP POCKET

12.2 D77 SWIM PLATFORM EXTENSION (FULL OPTION)

→ **INT D77P+SSWIMPA**
(PRT&STB PLTF WITH HARDWARE)

12.2.1 D77 PORT SWIM PLATFORM EXT (FULL OPTION)

→ **INT D77PSWIMPLTFPA**

SPARE PARTS FOR HOLDERS OF PRT SWIM PLATFORM EXTENSION OPTION



INT 879DEL474 *WITHOUT TEAK AND WINDLASS
D77 PORT SWIM PLATF

INT 2148050
RAIL, SS SWIM PLATFORM SUPPORT



12.2.1 D77 STB SWIM PLATFORM EXT (FULL OPTION)

→ **INT D77SSWIMPLTFPA**

SPARE PARTS FOR HOLDERS OF STB SWIM PLATFORM EXTENSION OPTION



INT 879DEL475
D77 STBD SWIM PLATF
*** WITHOUT TEAK**

INT 2176281
LADDER, 3STEP W/RAIL/PLT

INT 2148050
RAIL, SS SWIM PLATFORM SUPPORT



12.3 D77 SELECT W/AFT WNDLS (FULL OPTION)

→ **INT D77P+SSWIMINCLP**
(PRT & STB SWIN PLATFORMS WITH WINDLASS & HARDWARE)

12.3.1 D77 PORT SWIM PLATFORM EXT (FULL OPTION)

→ **INT D77PSWIMPLTFWPA**

SPARE PARTS FOR HOLDERS OF PRT SWIM PLATFORM EXTENSION OPTION



INT 879DEL474-W *WITHOUT TEAK
D77 PORT SWIM PLATF WINDL LAM

INT 2148050
RAIL, SS SWIM PLATFORM SUPPORT

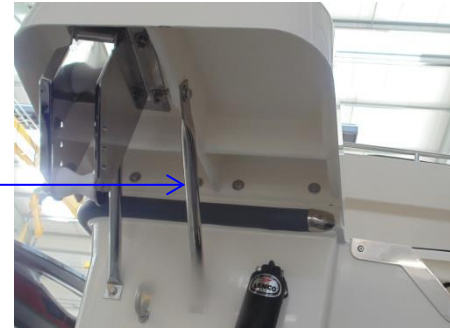

12.3.2 D77 STB SWIM PLATFORM EXT (FULL OPTION)

→ **INT D77SSWIMPLTFPA**

SPARE PARTS FOR HOLDERS OF STB SWIM PLATFORM EXTENSION OPTION



INT 879DEL475
D77 STBD SWIM PLATF
* WITHOUT TEAK

INT 2176281
LADDER, 3STEP W/RAIL/PLT

INT 2148050
RAIL, SS SWIM PLATFORM SUPPORT



13. D77 TRIM TABS (FULL OPTION)



INT D77TRIMTABPA



14. D77 BOW THRUSTER

SPARE PARTS FOR HOLDERS OF BOW THRUSTER OPTION

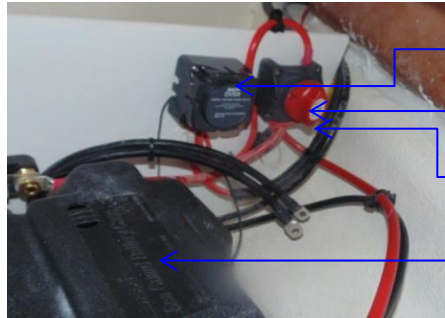

UTE 877238

INT 875851004

INT 2148033

INT 808775

RELAY CHARGING DUAL BAT

SINGLE BATTERY SWITCH

HARNES BOW THRUSTER

BOX-BATTERY @6 13X9X10

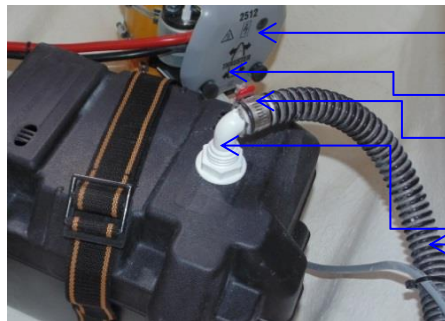

INT 2148032

INT 830968

INT 263954

INT 1699463

INT 1692922

THRUSTER BOW KIT 25KGF

COVER, CLAMP END 1/2" X .045"

HOSE CLAMP #10

THRU HULL, PLASTIC 3/4" X 90

3/4" ID CORR PVC WATER HOSE

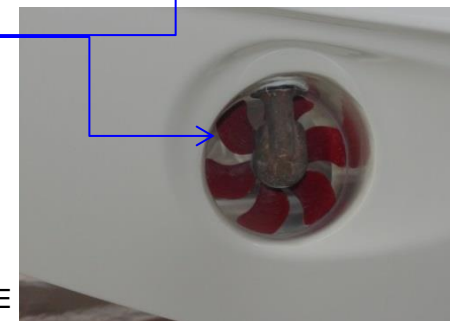

INT 2037135

THRU-HULL, PLAS SSCAP 3/4" S



INT 2080223

LABEL, BATT INSTLEU

15. D77 ENGINE OPTIONS

- 1. D77 BLNK L4 VERADO SC HYDRAULIC STEERING**
- 2. D77 VERADO 200 SC HYDRAULIC STEERING**
- 3. D77 VERADO 250 SC HYDRAULIC STEERING**
- 4. D77 VERADO 300 SC HYDRAULIC STEERING**
- 5. D77 VERADO 350 SC HYDRAULIC STEERING**
- 6. D77 TWIN 150 4STROKE HYDRAULIC**
- 7. D77 TWIN VERADO 200 HYDRAULIC**
- 8. D77 TWIN L4 BLNK VERADO SC**
- 9. D77 TWIN BLNK 150 4STROKE SC HYDRAULIC**
- 10. D77 BLNK L6 VERADO SC HYDRAULIC**

15.1 D77 BLNK L4 VERADO SC HYDRAULIC STEERING

SPARE PARTS FOR HOLDERS OF D77 BLNK L4 VERADO SC HYDRAULIC STEERING

INT 2148892	TRIM EDGE, SS TRNSM SNGL	
INT 875NAUO/B300CV *	NAUTECH O/B 300CV	* p/n available only to HIN BE-UTBEN004G617
INT 2160401 *	STEERING, CYLINDER UC128OBF	* new p/n available from HIN BE-UTBEN005G617
INT 2163479*	PLUG, PLASTIC 50X1-2.5 BLK	* new p/n available from HIN BE-UTBEN005G617
INT 2161863*	STEERING TILT MECHANISM X52	* new p/n available from HIN BE-UTBEN005G617
INT 2160400*	STEERING, KIT UP25T	* new p/n available from HIN BE-UTBEN005G617
INT 875897-BPTECH	OIL F/HYDRAULIC STEER	
INT 875OB55	KITOB55,500P,580P,600C,62	
Q/S 8M0079291	SLIM ERC WITH TRIM SALEABLE	
INT 123760	10MM FUELHOSE TYPE A1	
INT 123398	HOSE CLAMP #6	
INT 830976	COVER, CLAMP END 1/2"X.03	
Q/S 825191A03	+RIGGING HOSE KIT	
Q/S 892451T20	DATA HARNESS-20' L	
Q/S 893377K04	PANEL MNT COM MODULE KT-07 WF	
INT 2148042	PANEL, MAIN BATTERY SWITC	
Q/S 8590743	+BEZEL - CHROME, OMEGA GA	
Q/S 8M0101088	TACH7K/80MPH SGL ENG WHT KIT	
Q/S 859318T2	+JUNCTION BOX WEATHER CAP	
INT 2148046	CABLE KIT, BATTERY TWIN E	
Q/S 898160T01	+HARNESS-INSTRUMENT EXTEN	

15.2 D77 VERADO 200 SC HYDRAULIC STEERING

SPARE PARTS FOR HOLDERS OF D77 VERADO 200 SC HYDRAULIC STEERING

INT 2148892	TRIM EDGE, SS TRNSM SNGL	
INT 875NAUO/B300CV*	NAUTECH O/B 300CV	* p/n available only to HIN BE-UTBEN004G617
INT 2160401*	STEERING, CYLINDER UC128OBF	* new p/n available from HIN BE-UTBEN005G617
INT 2163479*	PLUG, PLASTIC 50X1-2.5 BLK	* new p/n available from HIN BE-UTBEN005G617
INT 2161863*	STEERING TILT MECHANISM X52	* new p/n available from HIN BE-UTBEN005G617
INT 2160400*	STEERING, KIT UP25T	* new p/n available from HIN BE-UTBEN005G617
INT 875897-BPTECH	OIL F/HYDRAULIC STEER	
INT 875OB55	KITOB55,500P,580P,600C,62	
Q/S 8M0079291	+SLIM ERC WITH TRIM SALEA	
INT 123760	10MM FUELHOSE TYPE A1	
INT 123398	HOSE CLAMP #6	
INT 830976	COVER, CLAMP END 1/2"X.03	
Q/S 825191A03	+RIGGING HOSE KIT	
Q/S 893377K04	+PANEL MNT COM MODULE KT-	
Q/S 892451T20	+DATA HARNESS-20' L	
INT 2148042	PANEL, MAIN BATTERY SWITC	
Q/S 8590743	+BEZEL - CHROME, OMEGA GA	
Q/S 8M0101088	TACH7K/80MPH SGL ENG WHT KIT	
Q/S 859318T2	+JUNCTION BOX WEATHER CAP	
INT 2148046	CABLE KIT, BATTERY TWIN E	
Q/S 898160T01	+HARNESS-INSTRUMENT EXTEN	
INT MER-1201V23ER	REFERENCE 200XL VERADO WO	
Q/S 8M0070074	+PROP - 15.6X 13RH, 3BL E	

15.3 D77 VERADO 250 SC HYDRAULIC STEERING

SPARE PARTS FOR HOLDERS OF D77 VERADO 250 SC HYDRAULIC STEERING

INT 2148892	TRIM EDGE, SS TRNSM SNGL	
Q/S 892380K12*	+40 CM STD KIT W/24 FT LE	* p/n available only to HIN BE-UTBEN004G617
Q/S 892560K31 *	40 CM TLT KT W/12	* new p/n available from HIN BE-UTBEN005G617
Q/S 892517	+FITTING-BULKHEAD 3/4	
Q/S 8M0046915	+HOSE KIT-POWER STEER 3'	
Q/S 892438K18	+HOSE KIT-POWER PACK-18 F	
Q/S 8M0046924	+HOSE KIT-POWER STEER 16'	
INT 875897-BPTECH	OIL F/HYDRAULIC STEER	
Q/S 8M0079291	+SLIM ERC WITH TRIM SALEA	
INT 123760	10MM FUELHOSE TYPE A1	
INT 123398	HOSE CLAMP #6	
INT 830976	COVER, CLAMP END 1/2"X.03	
Q/S 825191A03	+RIGGING HOSE KIT	
Q/S 893377K04	+PANEL MNT COM MODULE KT-	
Q/S 892451T20	+DATA HARNESS-20' L	
INT 2148042	PANEL, MAIN BATTERY SWITC	
Q/S 8590743	+BEZEL - CHROME, OMEGA GA	
Q/S 8M0101088	TACH7K/80MPH SGL ENG WHT KIT	
Q/S 859318T2	+JUNCTION BOX WEATHER CAP	
INT 2148046	CABLE KIT, BATTERY TWIN E	
Q/S 8M0113732	DTS CLEAN POWER HARNESS PKGD	
Q/S 88439A50	+BATTERY CABLE KIT	
Q/S 898160T01	+HARNESS-INSTRUMENT EXTEN	
INT MER-1250V23LD	REFERENCE 250 VER	
Q/S 898988A46	+PROP-RH 15.3 X 14P ENERT	

15.4 D77 VERADO 300 SC HYDRAULIC STEERING

SPARE PARTS FOR HOLDERS OF D77 VERADO 300 SC HYDRAULIC STEERING

INT 2148892	TRIM EDGE, SS TRNSM SNGL	
Q/S 892380K12*	+40 CM STD KIT W/24 FT LE	* p/n available only to HIN BE-UTBEN004G617
Q/S 892560K31 *	40 CM TLT KT W/12	* new p/n available from HIN BE-UTBEN005G617
Q/S 892517	+FITTING-BULKHEAD 3/4	
Q/S 8M0046915	+HOSE KIT-POWER STEER 3'	
Q/S 892438K18	+HOSE KIT-POWER PACK-18 F	
Q/S 8M0046924	+HOSE KIT-POWER STEER 16'	
INT 875897-BPTECH	OIL F/HYDRAULIC STEER	
Q/S 8M0079291	+SLIM ERC WITH TRIM SALEA	
INT 123760	10MM FUELHOSE TYPE A1	
INT 123398	HOSE CLAMP #6	
INT 830976	COVER, CLAMP END 1/2"X.03	
Q/S 825191A03	+RIGGING HOSE KIT	
Q/S 893377K04	+PANEL MNT COM MODULE KT-	
Q/S 892451T20	+DATA HARNESS-20' L	
INT 2148042	PANEL, MAIN BATTERY SWITC	
Q/S 8590743	+BEZEL - CHROME, OMEGA GA	
Q/S 8M0101088	TACH7K/80MPH SGL ENG WHT KIT	
Q/S 859318T2	+JUNCTION BOX WEATHER CAP	
INT 2148046	CABLE KIT, BATTERY TWIN E	
Q/S 8M0113732	DTS CLEAN POWER HARNESS PKGD	
Q/S 88439A50	+BATTERY CABLE KIT	
Q/S 898160T01	+HARNESS-INSTRUMENT EXTEN	
INT MER-1300V23LD	REFERENCE 300 VER	
Q/S 898990A46	+PROP-RH 015 X 15P ENERTI	

15.5 D77 VERADO 350 SC HYDRAULIC STEERING

SPARE PARTS FOR HOLDERS OF D77 VERADO 350 SC HYDRAULIC STEERING

INT 2148892	TRIM EDGE, SS TRNSM SNGL	
Q/S 892380K12 *	+40 CM STD KIT W/24 FT LE	* p/n available only to HIN BE-UTBEN004G617
Q/S 892560K31 *	40 CM TLT KT W/12	* new p/n available from HIN BE-UTBEN005G617
Q/S 892517	+FITTING-BULKHEAD 3/4	
Q/S 8M0046915	+HOSE KIT-POWER STEER 3'	
Q/S 892438K18	+HOSE KIT-POWER PACK-18 F	
Q/S 8M0046924	+HOSE KIT-POWER STEER 16'	
INT 875897-BPTECH	OIL F/HYDRAULIC STEER	
Q/S 8M0079291	+SLIM ERC WITH TRIM SALEA	
INT 123760	10MM FUELHOSE TYPE A1	
INT 123398	HOSE CLAMP #6	
INT 830976	COVER, CLAMP END 1/2"X.03	
Q/S 825191A03	+RIGGING HOSE KIT	
Q/S 893377K04	+PANEL MNT COM MODULE KT-	
Q/S 892451T20	+DATA HARNESS-20' L	
INT 2148042	PANEL, MAIN BATTERY SWITC	
Q/S 8590743	+BEZEL - CHROME, OMEGA GA	
Q/S 8M0101088	TACH7K/80MPH SGL ENG WHT KIT	
Q/S 859318T2	+JUNCTION BOX WEATHER CAP	
INT 2148046	CABLE KIT, BATTERY TWIN E	
Q/S 8M0113732	DTS CLEAN POWER HARNESS PKGD	
Q/S 88439A50	+BATTERY CABLE KIT	
Q/S 898160T01	+HARNESS-INSTRUMENT EXTEN	
Q/S 898990A46	+PROP-RH 015 X 15P ENERTI	
INT MER-1350V231F	REFERENCE 350 VER	
Q/S 840389Q06	PROP HUB KIT (H.D.)	

15.6 D77 TWIN 150 4STROKE HYDRAULIC

SPARE PARTS FOR HOLDERS OF D77 TWIN 150 4STROKE HYDRAULIC

INT 2148893	TRIM EDGE, SS TRNSM TWIN
INT 875NAUO/B300CV*	NAUTECH O/B 300CV
INT 2160401*	STEERING, CYLINDER UC128OBF
INT 2163479*	PLUG, PLASTIC 50X1-2.5 BLK
INT 2161863*	STEERING TILT MECHANISM X52
INT 2160400*	STEERING, KIT UP25T
INT 875897-BPTECH	OIL F/HYDRAULIC STEER
INT 875OB55	KITOB55,500P,580P,600C,62
INT 2112323	STEERING,TIE BAR 26" UFLE
Q/S 8M0075245	RC4500-DUL OB TRM
Q/S 8M0082542	CABLE, GEN II,19 FT HIGH EFFI
Q/S 897978A22	+CABLE-PREMIUM GEN II THR
Q/S 835257Q10	+FLO-TORQ IV HUB KIT
INT 123760	10MM FUELHOSE TYPE A1
INT 123398	HOSE CLAMP #6
INT 830976	COVER, CLAMP END 1/2"X.03
INT 1701950	VALVE,ANTISIPH3/8"BRBX1/4
INT 2118500	REDUCER,BRASS 3/8MPT X 1/
Q/S 825191A03	+RIGGING HOSE KIT
Q/S 896537K25	+HARNESS ASY W/MATCH KEYS
INT 2148045	PANEL, MAIN BATTERY SWITC
Q/S 8590743	+BEZEL - CHROME, OMEGA GA
Q/S 8M0101089	TACH7K/80 DUAL ENG WHT KIT 8.
Q/S 859318T2	+JUNCTION BOX WEATHER CAP
Q/S 19674A12	+DUAL-LANYRD STOP KT-FLUS
INT 2148046	CABLE KIT, BATTERY TWIN E
Q/S 892323T01	+DUAL ENG.INSTRUMENT ADAP
Q/S 893452A01	+CABLE ASY-LINK DTS
Q/S 898160T01	+HARNESS-INSTRUMENT EXTEN
Q/S 1128345	+SPACER-.26 X .50 X .45
INT MER-1150F23HD	REFERENCE 150XL EFI
INT MER-1150F24HD	REFERENCE F150CXL EFI
Q/S 898994A46	PROP-RH 014.5 X 17P ENER
Q/S 898995A46	PROP-LH 014.5 X 17P ENER

- * p/n available only to HIN BE-UTBEN004G617
- * new p/n available from HIN BE-UTBEN005G617
- * new p/n available from HIN BE-UTBEN005G617
- * new p/n available from HIN BE-UTBEN005G617
- * new p/n available from HIN BE-UTBEN005G617

15.7 D77 TWIN VERADO 200 HYDRAULIC

SPARE PARTS FOR HOLDERS OF D77 TWIN VERADO 200 HYDRAULIC

INT 2148893	TRIM EDGE, SS TRNSM TWIN
INT 875NAUO/B300CV	NAUTECH O/B 300CV
INT 2160401*	STEERING, CYLINDER UC128OBF
INT 2163479*	PLUG, PLASTIC 50X1-2.5 BLK
INT 2161863*	STEERING TILT MECHANISM X52
INT 2160400*	STEERING, KIT UP25T
INT 875897-BPTECH	OIL F/HYDRAULIC STEER
INT 875OB55	KITOB55,500P,580P,600C,62
INT 2112323	STEERING,TIE BAR 26" UFLE
Q/S 8M0096751	+ERC DUAL TRIM-(PKG 8M009)
INT 123760	10MM FUELHOSE TYPE A1
INT 123398	HOSE CLAMP #6
INT 830976	COVER, CLAMP END 1/2"X.03
INT 2118500	REDUCER,BRASS 3/8MPT X 1/
INT 1701950	VALVE,ANTISIPH3/8"BRBX1/4
Q/S 825191A03	+RIGGING HOSE KIT
Q/S 893378K04	+DUAL CONSL MNT COM MDL K
INT 2148045	PANEL, MAIN BATTERY SWITC
Q/S 8590743	+BEZEL - CHROME, OMEGA GA
Q/S 8M0101089	TACH7K/80 DUAL ENG WHT KIT 8
Q/S 859318T2	+JUNCTION BOX WEATHER CAP
Q/S 892451T20	+DATA HARNESS-20' L
INT 2148046	CABLE KIT, BATTERY TWIN E
Q/S 892323T01	+DUAL ENG.INSTRUMENT ADAP
Q/S 893452A01	+CABLE ASY-LINK DTS
Q/S 898160T01	+HARNESS-INSTRUMENT EXTEN
Q/S 1128345	+SPACER-.26 X .50 X .45
Q/S 856954	BUSHING-ELECTRICAL PLATE
INT MER-1201V23ER	REFERENCE 200XL VERADO WO
INT MER-1201V24ER	REFERENCE 200CXL VERADO C
Q/S 898998A46	+PROP-RH 014 X 19P ENERTI
Q/S 898999A46	+PROP-LH 014 X 19P ENERTI

- * p/n available only to HIN BE-UTBEN004G617
- * new p/n available from HIN BE-UTBEN005G617
- * new p/n available from HIN BE-UTBEN005G617
- * new p/n available from HIN BE-UTBEN005G617
- * new p/n available from HIN BE-UTBEN005G617

15.8 D77 TWIN L4 BLNK VERADO SC

SPARE PARTS FOR HOLDERS OF D77 TWIN L4 BLNK VERADO SC

INT 2148893	TRIM EDGE, SS TRNSM TWIN
INT 875NAUO/B300CV	NAUTECH O/B 300CV
INT 2160401*	STEERING, CYLINDER UC128OBF
INT 2163479*	PLUG, PLASTIC 50X1-2.5 BLK
INT 2161863*	STEERING TILT MECHANISM X52
INT 2160400*	STEERING, KIT UP25T
INT 875897-BPTECH	OIL F/HYDRAULIC STEER
INT 875OB55	KITOB55,500P,580P,600C,62
INT 2112323	STEERING,TIE BAR 26" UFLE
Q/S 8M0096751	+ERC DUAL TRIM-(PKG 8M009)
INT 123760	10MM FUELHOSE TYPE A1
INT 123398	HOSE CLAMP #6
INT 830976	COVER, CLAMP END 1/2"X.03
INT 2118500	REDUCER,BRASS 3/8MPT X 1/
INT 1701950	VALVE,ANTISIPH3/8"BRBX1/4
Q/S 825191A03	+RIGGING HOSE KIT
Q/S 893378K04	+DUAL CONSL MNT COM MDL K
INT 2148045	PANEL, MAIN BATTERY SWITC
Q/S 8590743	+BEZEL - CHROME, OMEGA GA
Q/S 8M0101089	TACH7K/80 DUAL ENG WHT KIT 8
Q/S 859318T2	+JUNCTION BOX WEATHER CAP
Q/S 892451T20	+DATA HARNESS-20' L
INT 2148046	CABLE KIT, BATTERY TWIN E
Q/S 892323T01	+DUAL ENG.INSTRUMENT ADAP
Q/S 893452A01	+CABLE ASY-LINK DTS
Q/S 898160T01	+HARNESS-INSTRUMENT EXTEN
Q/S 856954	BUSHING-ELECTRICAL PLATE
Q/S 1128345	+SPACER-.26 X .50 X .45

- * p/n available only to HIN BE-UTBEN004G617
- * new p/n available from HIN BE-UTBEN005G617
- * new p/n available from HIN BE-UTBEN005G617
- * new p/n available from HIN BE-UTBEN005G617
- * new p/n available from HIN BE-UTBEN005G617

15.9 D77 TWIN BLNK 150 4STROKE SC HYDRAULIC

SPARE PARTS FOR HOLDERS OF D77 TWIN BLNK 150 4STROKE SC HYDRAULIC

INT 2148893	TRIM EDGE, SS TRNSM TWIN	
INT 875NAUO/B300CV	NAUTECH O/B 300CV	* p/n available only to HIN BE-UTBEN004G617
INT 2160401*	STEERING, CYLINDER UC128OBF	* new p/n available from HIN BE-UTBEN005G617
INT 2163479*	PLUG, PLASTIC 50X1-2.5 BLK	* new p/n available from HIN BE-UTBEN005G617
INT 2161863*	STEERING TILT MECHANISM X52	* new p/n available from HIN BE-UTBEN005G617
INT 2160400*	STEERING, KIT UP25T	* new p/n available from HIN BE-UTBEN005G617
INT 875897-BPTECH	OIL F/HYDRAULIC STEER	
INT 875OB55	KITOB55,500P,580P,600C,62	
INT 2112323	STEERING,TIE BAR 26" UFLE	
Q/S 8M0075245	RC4500-DUL OB TRM	
Q/S 8M0082542	+CABLE, GEN II,19 FT HIGH EFFI	
Q/S 897978A22	+CABLE-PREMIUM GEN II THR	
INT 123760	10MM FUELHOSE TYPE A1	
INT 123398	HOSE CLAMP #6	
INT 830976	COVER, CLAMP END 1/2"X.03	
INT 1701950	VALVE,ANTISIPH3/8"BRBX1/4	
INT 2118500	REDUCER,BRASS 3/8MPT X 1/	
Q/S 825191A03	+RIGGING HOSE KIT	
Q/S 896537K25	+HARNESS ASY W/MATCH KEYS	
INT 2148045	PANEL, MAIN BATTERY SWITC	
Q/S 8590743	+BEZEL - CHROME, OMEGA GA	
Q/S 8M0101089	TACH7K/80 DUAL ENG WHT KIT 8.	
Q/S 859318T2	+JUNCTION BOX WEATHER CAP	
Q/S 19674A12	+DUAL-LANYRD STOP KT-FLUS	
INT 2148046	CABLE KIT, BATTERY TWIN E	
Q/S 892323T01	+DUAL ENG.INSTRUMENT ADAP	
Q/S 893452A01	+CABLE ASY-LINK DTS	
Q/S 898160T01	+HARNESS-INSTRUMENT EXTEN	
Q/S 1128345	+SPACER-.26 X .50 X .45	

15.10 D77 BLNK L6 VERADO SC HYDRAULIC SC

SPARE PARTS FOR HOLDERS OF D77 BLNK L6 VERADO SC HYDRAULIC SC

Q/S 892380K12 *	40 CM STD KIT W/24 FT LE	* p/n available only to HIN BE-UTBEN004G617
Q/S 892560K31 *	40 CM TLT KT W/12	* new p/n available from HIN BE-UTBEN005G617
INT 2148892	+40 CM STD KIT W/24 FT LE	
Q/S 892517	+HOSE KIT-POWER STEER 3'	
Q/S 8M0046915	+HOSE KIT-POWER PACK-18 F	
Q/S 892438K18	+HOSE KIT-POWER STEER 16'	
Q/S 8M0046924	OIL F/HYDRAULIC STEER	
INT 875897-BPTECH	+SLIM ERC WITH TRIM SALEA	
Q/S 8M0079291	10MM FUELHOSE TYPE A1	
INT 123760	HOSE CLAMP #6	
INT 123398	COVER, CLAMP END 1/2"X.03	
INT 830976	+RIGGING HOSE KIT	
Q/S 825191A03	+PANEL MNT COM MODULE KT-	
Q/S 893377K04	+DATA HARNESS-20' L	
Q/S 892451T20	PANEL, MAIN BATTERY SWITC	
INT 2148042	+BEZEL - CHROME, OMEGA GA	
Q/S 8590743	TACH7K/80MPH SGL ENG WHT KIT	
Q/S 8M0101088	+JUNCTION BOX WEATHER CAP	
Q/S 859318T2	CABLE KIT, BATTERY TWIN E	
INT 2148046	CABLE KIT, BATTERY TWIN EN/CD	
Q/S 898160T01	HARNESS-INSTRUMENT EXTENSION	

